

# emWin

Graphic Library with  
Graphic User Interface

User Guide & Reference Manual

Document: UM03001  
Software Version: 6.48  
Revision: 0  
Date: December 19, 2024

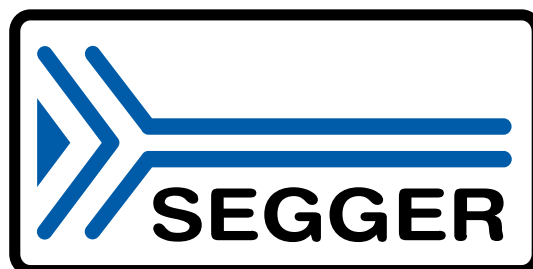

A product of SEGGER Microcontroller GmbH

[www.segger.com](http://www.segger.com)

## Disclaimer

The information written in this document is assumed to be accurate without guarantee. The information in this manual is subject to change for functional or performance improvements without notice. SEGGER Microcontroller GmbH (SEGGER) assumes no responsibility for any errors or omissions in this document. SEGGER disclaims any warranties or conditions, express, implied or statutory for the fitness of the product for a particular purpose. It is your sole responsibility to evaluate the fitness of the product for any specific use.

## Copyright notice

You may not extract portions of this manual or modify the PDF file in any way without the prior written permission of SEGGER. The software described in this document is furnished under a license and may only be used or copied in accordance with the terms of such a license.

© 2024 SEGGER Microcontroller GmbH, Monheim am Rhein / Germany

## Trademarks

Names mentioned in this manual may be trademarks of their respective companies.

Brand and product names are trademarks or registered trademarks of their respective holders.

## Contact address

SEGGER Microcontroller GmbH

Ecolab-Allee 5  
D-40789 Monheim am Rhein

Germany

Tel.           +49 2173-99312-0  
Fax.           +49 2173-99312-28  
E-mail:       support@segger.com\*  
Internet:     [www.segger.com](http://www.segger.com)

---

\*By sending us an email your (personal) data will automatically be processed. For further information please refer to our privacy policy which is available at <https://www.segger.com/legal/privacy-policy/>.

## Manual versions

This manual describes the current software version. If you find an error in the manual or a problem in the software, please inform us and we will try to assist you as soon as possible. Contact us for further information on topics or functions that are not yet documented.

Print date: December 19, 2024

Software	Revision	Date	By	Description
6.48	0	241219	FO JE	Chapter <i>Displaying Scalable Vector Graphics (SVG) files</i> updated. <ul style="list-style-type: none"> <li>New function <code>GUI_SVG_DRIVER_SetVersion()</code> added.</li> <li>Add support for NemaVG 1.1.7 to <code>GUI_SVG_DRIVER_NEMAVG</code>.</li> </ul> Chapter <i>Tools</i> updated. <ul style="list-style-type: none"> <li>New option added to <code>emWin4Web</code> for generating standalone HTML.</li> </ul> Chapter <i>Widgets</i> updated. <ul style="list-style-type: none"> <li>New function <code>GAUGE_GetArcPositions()</code> added.</li> </ul> Chapter <i>Info about screen changes</i> updated. <ul style="list-style-type: none"> <li>New object <code>GUI_DIRTYTILES</code> for optimizing multiple buffering.</li> </ul>
6.46	0	241011	FO	Chapter <i>Introduction to emWin</i> updated. <ul style="list-style-type: none"> <li>Sub-section "Starter kits" removed.</li> </ul> Chapter <i>Getting started</i> updated. <ul style="list-style-type: none"> <li>New sub-section for CMake support added.</li> </ul> New chapter <i>emWin in Web Browsers: Emscripten support</i> added. <ul style="list-style-type: none"> <li>New function <code>GUI_EMSCRIPTEN_GetNow()</code> added.</li> <li>New function <code>GUI_EMSCRIPTEN_GetNowTimezone()</code> added.</li> </ul> New sub-chapter <i>emWin4Web</i> added. <ul style="list-style-type: none"> <li>New command-line tool for building emWin applications for web browsers with Emscripten.</li> </ul> Chapter <i>Displaying Scalable Vector Graphics (SVG) files</i> updated. <ul style="list-style-type: none"> <li>New SVG driver for NanoVG added.</li> </ul>
6.44	0	240731	FO	Chapter <i>Configuration</i> updated. <ul style="list-style-type: none"> <li>Sub-chapter "Framebuffer cache" added.</li> <li>Sub-chapter "Hook functions" added.</li> <li>New function <code>GUI_GCACHE_Create()</code> added.</li> <li>New function <code>GUI_GCACHE_CreateEx()</code> added.</li> <li>New function <code>GUI_GCACHE_CreateUserEx()</code> added.</li> </ul> Chapter <i>2-D Graphic Library</i> updated. <ul style="list-style-type: none"> <li>Function <code>GUI_SaveContext()</code> removed from documentation.</li> <li>Function <code>GUI_RestoreContext()</code> removed from documentation.</li> <li>Function <code>GUI_GCACHE_1_Create()</code> removed.</li> <li>Function <code>GUI_GCACHE_1_CreateEx()</code> removed.</li> <li>Function <code>GUI_GCACHE_4_Create()</code> removed.</li> <li>Function <code>GUI_GCACHE_4_CreateEx()</code> removed.</li> </ul> New chapter <i>File Access: GetData() functions</i> added. <ul style="list-style-type: none"> <li>Reworked explanations for all <code>GetData()</code> functions.</li> <li>Function typedefs added to each module that uses a <code>GetData</code> function, to provide clearer requirements for these functions.</li> </ul>
6.42	0	240503	JE	Chapter <i>Fonts</i> updated. <ul style="list-style-type: none"> <li>New function <code>GUI_AttachKerning()</code> added.</li> <li>New function <code>GUI_DetachKerning()</code> added.</li> <li>New function <code>GUI_TTF_EnableKerning()</code> added.</li> </ul> Chapter <i>Widgets</i> updated. <ul style="list-style-type: none"> <li>New function <code>KEYBOARD_LockShiftState()</code> added.</li> <li>New function <code>KEYBOARD_SetShiftState()</code> added.</li> </ul> Chapter <i>Display drivers</i> updated. <ul style="list-style-type: none"> <li>Driver template removed.</li> </ul>
6.40	0	240503	FO JE	Chapter <i>Displaying Scalable Vector Graphics (SVG) files</i> updated. <ul style="list-style-type: none"> <li>New SVG driver for NemaVG added.</li> <li>New function <code>GUI_SVG_DRIVER_BindAPI()</code> added.</li> <li>New function <code>GUI_SVG_DRIVER_BindDynamicAPI()</code> added.</li> <li>New function <code>GUI_SVG_DRIVER_GetSelected()</code> added.</li> <li>New function <code>GUI_SVG_DRIVER_HasBoundAPI()</code> added.</li> <li>New function <code>GUI_SVG_DRIVER_Select()</code> added.</li> <li>New function <code>GUI_SVG_DRIVER_SetHooks()</code> added.</li> <li>Function <code>GUI_SVG_SetHooks()</code> removed.</li> <li>Function <code>GUI_SVG_SetAPI_VGLite()</code> removed.</li> <li>Function <code>GUI_SVG_SetAPI_OpenVG()</code> removed.</li> <li>Function <code>GUI_SVG_LoadAPI_OpenVG()</code> removed.</li> </ul> Chapter <i>Widgets</i> updated. <ul style="list-style-type: none"> <li>New function <code>WHEEL_SetOwnerDraw()</code> added.</li> <li>New function <code>WHEEL_OwnerDrawMorph()</code> added.</li> </ul>

Software	Revision	Date	By	Description
				<ul style="list-style-type: none"> <li>• New function <code>WHEEL_OwnerDrawPlain()</code> added.</li> </ul> Chapter <i>Fonts</i> updated. <ul style="list-style-type: none"> <li>• New function <code>GUI_TTF_AddRowBottom()</code> added.</li> <li>• New function <code>GUI_TTF_AddRowTop()</code> added.</li> </ul> Chapter <i>Display drivers</i> updated. <ul style="list-style-type: none"> <li>• New function <code>GUIDRV_Lin_SetThreshold()</code> added.</li> </ul> Chapter <i>Bitmap Converter</i> updated. <ul style="list-style-type: none"> <li>• New bitmap format A8 (alpha channel only) added. It also speeds up drawing of TTF fonts with antialiasing considerably.</li> </ul> Chapter <i>Animations</i> updated. <ul style="list-style-type: none"> <li>• New function <code>GUI_ANIM_GetPeriod()</code> added.</li> </ul>
6.38	0	240315	JE FO	Chapter <i>Displaying Scalable Vector Graphics (SVG) files</i> updated. <ul style="list-style-type: none"> <li>• Support for embedded images added.</li> <li>• New function <code>GUI_SVG_EnablePNG()</code> added.</li> <li>• New function <code>GUI_SVG_EnableJPEG()</code> added.</li> <li>• New function <code>GUI_SVG_EnableGIF()</code> added.</li> <li>• New function <code>GUI_SVG_EnableBMP()</code> added.</li> <li>• New function <code>GUI_SVG_EnableCacheMode()</code> added.</li> <li>• New function <code>GUI_SVG_Render()</code> added.</li> <li>• New function <code>GUI_SVG_SetBkColor()</code> added.</li> <li>• New function <code>GUI_SVG_SetDPI()</code> added.</li> <li>• New function <code>GUI_SVG_SetFileBufferSize()</code> added.</li> <li>• New function <code>GUI_SVG_LoadAPI_OpenVG()</code> added.</li> </ul> Chapter <i>Memory Devices</i> updated. <ul style="list-style-type: none"> <li>• Support for memory bitmaps added.</li> <li>• New function <code>GUI_MBITMAP_Create()</code> added.</li> <li>• New function <code>GUI_MBITMAP_CreateEx()</code> added.</li> <li>• New function <code>GUI_MBITMAP_CreateUser()</code> added.</li> <li>• New function <code>GUI_MBITMAP_CreateUserEx()</code> added.</li> <li>• New function <code>GUI_MBITMAP_Delete()</code> added.</li> <li>• New function <code>GUI_MBITMAP_SetColorFormat()</code> added.</li> </ul>
6.36	0	231219	FO	Chapter <i>Introduction</i> updated. <ul style="list-style-type: none"> <li>• Section "Features" updated.</li> </ul> Chapter <i>Configuration</i> updated. <ul style="list-style-type: none"> <li>• NXP Pixel Pipeline: Limitation lifted that rotated configurations were not supported.</li> <li>• New hardware accelerator Vivante VGLite added.</li> </ul> New chapter <i>Displaying Scalable Vector Graphics (SVG) files</i> added.           Chapter <i>Fonts</i> updated. <ul style="list-style-type: none"> <li>• Font types renamed. Font types that were called "Standard" are now called "Legacy". Font types that were called "Extended" are now called "Standard".</li> <li>• <i>XBF font types</i> defines renamed.</li> <li>• <i>SIF font types</i> defines renamed.</li> </ul> Chapter <i>Font Converter</i> updated. <ul style="list-style-type: none"> <li>• Font Converter tool completely rewritten.</li> </ul>
6.34	0	230705	FO	Chapter <i>Displaying bitmap files</i> updated. <ul style="list-style-type: none"> <li>• New sub-chapter "IDCT configuration" added.</li> <li>• New function <code>GUI_JPEG_SetpfWritePixels()</code> added.</li> <li>• New prototype <code>GUI_JPEG_WRITECLIPPEDPIXELS_FUNC</code> added.</li> </ul> Chapter <i>Memory Devices</i> updated. <ul style="list-style-type: none"> <li>• Example code for <code>GUI_MEMDEV_Rotate()</code> functions updated.</li> </ul>
6.32	0	230117	FO	Chapter <i>Getting Started</i> updated. <ul style="list-style-type: none"> <li>• Section "Subdirectories" updated.</li> </ul> Chapter <i>Configuration</i> updated. <ul style="list-style-type: none"> <li>• Support for NXP's Pixel Pipeline added.</li> <li>• New function <code>GUI_MEMDEV_SetBlendFunc()</code> added.</li> <li>• New function <code>GUI_SetFuncDrawBitmapEx()</code> added.</li> <li>• New functions <code>GUI_MEMDEV_SetRotateFuncLR()</code> and <code>GUI_MEMDEV_SetRotateFuncHR()</code> added.</li> </ul> Chapter <i>Movies</i> updated. <ul style="list-style-type: none"> <li>• New function <code>MOVIE_GetInfo()</code> added.</li> </ul> Chapter <i>Language Support</i> updated. <ul style="list-style-type: none"> <li>• TXT file rules updated: line feeds are now supported.</li> </ul> Chapter <i>Widgets</i> updated. <ul style="list-style-type: none"> <li>• New TICKER widget added.</li> <li>• Fixed wrong images at <code>GRAPH_SetGridDistX()</code>.</li> <li>• New function <code>SCROLLER_SetContentRect()</code> added.</li> </ul>
6.30	0	221121	FO	Chapter <i>Colors</i> updated. <ul style="list-style-type: none"> <li>• New function <code>GUI_SetBlendColor()</code> added.</li> <li>• New function <code>GUI_SetBlendColorEx()</code> added.</li> </ul>

Software	Revision	Date	By	Description
				<ul style="list-style-type: none"> <li>• New function GUI_SetBlendBkColor() added.</li> <li>• New function GUI_SetBlendBkColorEx() added.</li> </ul> Chapter <i>Movies</i> updated. <ul style="list-style-type: none"> <li>• Section about new tool MakeMovie.exe added.</li> <li>• New function GUI_MOVIE_SetSecondHandle() added.</li> <li>• New function GUI_MOVIE_IsPlaying() added.</li> </ul> Chapter <i>The Window Manager (WM)</i> updated. <ul style="list-style-type: none"> <li>• New function WM_GetChild() added.</li> <li>• New function WM_GetScrollerV() added.</li> <li>• New function WM_GetScrollerH() added.</li> <li>• New function WM_GetScrollPartner() added.</li> </ul> Chapter <i>Widgets</i> updated. <ul style="list-style-type: none"> <li>• New MOVIE widget added.</li> <li>• New function GAUGE_EnableCCW() added.</li> <li>• New function SWITCH_SetThumbSize() added.</li> <li>• New function KEYBOARD_GetDefaultColor() added.</li> <li>• New function KEYBOARD_GetDefaultFrameSize() added.</li> <li>• New function KEYBOARD_GetDefaultPeriod() added.</li> <li>• New function KEYBOARD_GetDefaultRadius() added.</li> <li>• New function KEYBOARD_GetDefaultSpace() added.</li> <li>• New function KEYBOARD_SetDefaultColor() added.</li> <li>• New function KEYBOARD_SetDefaultFrameSize() added.</li> <li>• New function KEYBOARD_SetDefaultPeriod() added.</li> <li>• New function KEYBOARD_SetDefaultRadius() added.</li> <li>• New function KEYBOARD_SetDefaultSpace() added.</li> <li>• New function WIDGET_GetMinTimePerFrame() added.</li> <li>• New function WIDGET_SetMinTimePerFrame() added.</li> </ul>
6.28	0	220909	FO	Chapter <i>2-D Graphic Library</i> updated. <ul style="list-style-type: none"> <li>• New function GUI_GCACHE_1_Create() added.</li> <li>• New function GUI_GCACHE_1_CreateEx() added.</li> </ul> Chapter <i>Colors</i> updated. <ul style="list-style-type: none"> <li>• New function GUI_BlendColors() added.</li> </ul> Chapter <i>Fonts</i> updated. <ul style="list-style-type: none"> <li>• Section 'Changing the font style during run-time' added.</li> </ul> Chapter <i>The Window Manager (WM)</i> updated. <ul style="list-style-type: none"> <li>• New function WM_GetCapture() added.</li> </ul> Chapter <i>Widgets</i> updated. <ul style="list-style-type: none"> <li>• New function WIDGET_GetType() added.</li> <li>• New function EDIT_SetPasswordChar() added.</li> <li>• New function EDIT_SetPasswordMode() added.</li> <li>• New function LISTBOX_Clear() added.</li> <li>• New function LISTVIEW_GetOverlap() added.</li> <li>• New function LISTVIEW_SetOverlap() added.</li> <li>• Parameter description in LISTBOX_SetFixedScrollPos() corrected.</li> <li>• New function LISTBOX_GetFixedScrollPos() added.</li> <li>• WIDGET_ITEM_DRAW_TEXT, WIDGET_ITEM_DRAW_BACKGROUND and WIDGET_ITEM_DRAW_FOCUS added to LISTBOX_OwnerDraw(). The old command WIDGET_ITEM_DRAW is still supported.</li> <li>• New function KEYBOARD_GetKeyRect() added.</li> <li>• Changed prototype of function pointer being set by EDIT_SetpfAddKeyEx(). The function returns a value now.</li> </ul> Chapter <i>Anti-aliasing</i> updated. <ul style="list-style-type: none"> <li>• GUI_AA_DrawPolyOutlineEx() removed, compatibility macro added which will call GUI_AA_DrawPolyOutline() instead.</li> </ul> Chapter <i>Memory Devices</i> updated. <ul style="list-style-type: none"> <li>• New function GUI_MEMDEV_CopyRect() added.</li> </ul> Chapter <i>Bitmap Converter</i> updated. <ul style="list-style-type: none"> <li>• Command table updated and restructured.</li> <li>• -ditherinto... commands added.</li> </ul>
6.26	0	220428	FO	Chapter <i>The Window Manager (WM)</i> updated. <ul style="list-style-type: none"> <li>• New function WM_GetContentRect() added.</li> <li>• New function WM_GetContentRectEx() added.</li> <li>• New function WM_IsUntouchable() added.</li> </ul> Chapter <i>Widgets</i> updated. <ul style="list-style-type: none"> <li>• New SCROLLER widget added: smartphone-like scroll bar widget.</li> <li>• New WHEEL widget added: new and improved version of the LISTWHEEL widget.</li> <li>• Parameters of SWIPELIST_GetOverlap() changed.</li> <li>• Parameters of SWIPELIST_SetOverlap() changed.</li> <li>• Parameters of SWIPELIST_GetDefaultOverlap() changed.</li> <li>• Parameters of SWIPELIST_SetDefaultOverlap() changed.</li> </ul>

Software	Revision	Date	By	Description
6.24	0	220118	FO	<p>Chapter <i>Configuration</i> updated.</p> <ul style="list-style-type: none"> <li>• New function GUI_SetOnLogFunc() added.</li> <li>• New function GUI_SetOnWarnFunc() added.</li> </ul> <p>Chapter <i>2-D Graphic Library</i> updated.</p> <ul style="list-style-type: none"> <li>• New function GUI_DrawArchREx() added.</li> <li>• New function GUI_DrawFrame() added.</li> <li>• New function GUI_DrawFrameEx() added.</li> </ul> <p>Chapter <i>Displaying bitmap files</i> updated.</p> <ul style="list-style-type: none"> <li>• Added "Limitations" sub-section to JPEG section.</li> </ul> <p>Chapter <i>Colors</i> updated.</p> <ul style="list-style-type: none"> <li>• Added new color conversion GUICC_666_18.</li> <li>• Added new color conversion GUICC_M666_18.</li> </ul> <p>Chapter <i>Widgets</i> updated.</p> <ul style="list-style-type: none"> <li>• New function DROPDOWN_Clear() added.</li> <li>• New function DROPDOWN_SetText() added.</li> <li>• New function HEADER_GetBorderH() added.</li> <li>• New function HEADER_GetBorderV() added.</li> <li>• New function HEADER_SetBorderH() added.</li> <li>• New function HEADER_SetBorderV() added.</li> <li>• New function LISTVIEW_Clear() added.</li> <li>• New function LISTVIEW_GetGridColor() added.</li> <li>• New function LISTVIEW_SetGridColor() added.</li> </ul> <p>Chapter <i>Anti-aliasing</i> updated.</p> <ul style="list-style-type: none"> <li>• New function GUI_AA_SetBufferSize() added.</li> </ul>
6.22	0	211116	FO	<p>Chapter <i>Colors</i> updated.</p> <ul style="list-style-type: none"> <li>• New color conversion GUICC_8888I added.</li> </ul> <p>Chapter <i>Fonts</i> updated.</p> <ul style="list-style-type: none"> <li>• New function GUI_BDF_EmboldenFont() added.</li> <li>• New function GUI_BDF_EmboldenFontEx() added.</li> <li>• New function GUI_BDF_SetLetterSpacing() added.</li> <li>• New function GUI_FT_GetMeasurementChars() added.</li> <li>• New function GUI_FT_SetMeasurementChars() added.</li> <li>• New function GUI_TTF_EmboldenFont() added.</li> <li>• New function GUI_TTF_EmboldenFontEx() added.</li> <li>• New function GUI_TTF_ObliqueFont() added.</li> <li>• New function GUI_TTF_ObliqueFontEx() added.</li> </ul> <p>Chapter <i>The Window Manager (WM)</i> updated.</p> <ul style="list-style-type: none"> <li>• Section 'Widgets with motion support' added.</li> <li>• New function WM_DeleteWindowSecure() added.</li> </ul> <p>Chapter <i>Widgets</i> updated.</p> <ul style="list-style-type: none"> <li>• New function DROPDOWN_EnableMotion() added.</li> <li>• DROPDOWN widget now sends DROPDOWN_NOTIFICATION_COLLAPSED and DROPDOWN_NOTIFICATION_EXPANDED notifications to its parent.</li> <li>• New function LISTVIEW_GetDefaultBkColor() added.</li> <li>• New function LISTVIEW_GetDefaultFont() added.</li> <li>• New function LISTVIEW_GetDefaultGridColor() added.</li> <li>• New function LISTVIEW_GetDefaultScrollStepH() added.</li> <li>• New function LISTVIEW_GetDefaultTextColor() added.</li> <li>• New function LISTVIEW_SetDefaultScrollStepH() added.</li> <li>• New function LISTVIEW_SetScrollStepH() added.</li> <li>• New function LISTVIEW_GetScrollStepH() added.</li> <li>• New function LISTVIEW_SetScrollPos() added.</li> <li>• New function MULTIEDIT_GetDefaultAlign() added.</li> <li>• New function MULTIEDIT_GetDefaultBkColor() added.</li> <li>• New function MULTIEDIT_GetDefaultCursorColor() added.</li> <li>• New function MULTIEDIT_GetDefaultFont() added.</li> <li>• New function MULTIEDIT_GetDefaultHBorder() added.</li> <li>• New function MULTIEDIT_GetDefaultTextColor() added.</li> <li>• New function MULTIEDIT_SetDefaultAlign() added.</li> <li>• New function MULTIEDIT_SetDefaultBkColor() added.</li> <li>• New function MULTIEDIT_SetDefaultCursorColor() added.</li> <li>• New function MULTIEDIT_SetDefaultFont() added.</li> <li>• New function MULTIEDIT_SetDefaultHBorder() added.</li> <li>• New function MULTIEDIT_SetDefaultTextColor() added.</li> <li>• New function SWITCH_DisableAnimation() added.</li> <li>• SWIPELIST widget now sends notifications when its overlap area has been reached or released.</li> </ul> <p>Chapter <i>emWinView</i> updated.</p> <ul style="list-style-type: none"> <li>• Selection position and size can now be edited from a dialog.</li> </ul>
6.20	0	210810	FO	<p>Chapter <i>Displaying Text</i> updated.</p> <ul style="list-style-type: none"> <li>• New function GUI_GetShowMissingCharacters() added.</li> </ul> <p>Chapter <i>2-D Graphic Library</i> updated.</p>

Software	Revision	Date	By	Description
				<ul style="list-style-type: none"> <li>• New function <code>GUI_DrawArcHR()</code> added.</li> <li>• New function <code>GUI_DrawPieHR()</code> added.</li> </ul> <p>Chapter <i>Fonts</i> updated.</p> <ul style="list-style-type: none"> <li>• 'Requirements' section added.</li> </ul> <p>Chapter <i>Movies</i> updated.</p> <ul style="list-style-type: none"> <li>• Bitmap-based emWin movie files added.</li> </ul> <p>Chapter <i>Widgets</i> updated.</p> <ul style="list-style-type: none"> <li>• New function <code>GAUGE_GetRange()</code> added.</li> <li>• Fixed mistakes in the SPINBOX configuration options table.</li> <li>• New function <code>IMAGE_SetAlign()</code> added.</li> <li>• New function <code>IMAGE_SetOffset()</code> added.</li> <li>• New function <code>IMAGE_SetAlpha()</code> added.</li> <li>• New function <code>IMAGE_SetAngle()</code> added.</li> <li>• New function <code>IMAGE_SetScale()</code> added.</li> <li>• New function <code>IMAGE_EnableLQ()</code> added.</li> </ul> <p>Chapter <i>VNC server</i> updated.</p> <ul style="list-style-type: none"> <li>• Multiple VNC connections to the same layer are now possible.</li> <li>• Section for connection with a web browser added.</li> </ul> <p>Chapter <i>Anti-aliasing</i> updated.</p> <ul style="list-style-type: none"> <li>• New function <code>GUI_AA_DrawPie()</code> added.</li> </ul> <p>Chapter <i>Bitmap Converter</i> updated.</p> <ul style="list-style-type: none"> <li>• Bitmap-based emWin movie files added.</li> </ul> <p>Chapter <i>Display drivers</i> updated.</p> <ul style="list-style-type: none"> <li>• <code>GUIDRV_SLinEPD_SSD1673</code> now supports SSD1680.</li> <li>• <code>GUIDRV_SLinEPD</code> now supports UC8451.</li> <li>• <code>GUIDRV_FlexColor</code> now supports ST7715.</li> </ul> <p>Chapter <i>Support</i> updated.</p> <ul style="list-style-type: none"> <li>• Fixed typo and updated FAQ.</li> </ul>
6.18	0	210503	JE FO	<p>Chapter <i>Fonts</i> updated.</p> <ul style="list-style-type: none"> <li>• New function <code>GUI_BDF_CreateFont()</code> added.</li> <li>• New function <code>GUI_BDF_DeleteFont()</code> added.</li> <li>• New function <code>GUI_BDF_GetFamilyName()</code> added.</li> <li>• New function <code>GUI_BDF_GetStyleName()</code> added.</li> <li>• Function <code>GUI_TTF_DestroyCache()</code> renamed to <code>GUI_FT_DestroyCache()</code>.</li> <li>• Function <code>GUI_TTF_Done()</code> renamed to <code>GUI_FT_Done()</code>.</li> <li>• Function <code>GUI_TTF_SetCacheSize()</code> renamed to <code>GUI_FT_SetCacheSize()</code>.</li> <li>• New function <code>GUI_GetFallbackFont()</code> added.</li> <li>• New function <code>GUI_SetFallbackFont()</code> added.</li> <li>• New function <code>GUI_SetFuncGetFallbackFont()</code> added.</li> </ul> <p>Chapter <i>Font Converter</i> updated.</p> <ul style="list-style-type: none"> <li>• New command line options added added.</li> </ul> <p>Chapter <i>Simulation</i> updated.</p> <ul style="list-style-type: none"> <li>• New function <code>SIM_GUI_EnableModifierKey()</code> added.</li> <li>• New function <code>SIM_GUI_IsModifierKeyEnabled()</code> added.</li> </ul> <p>Chapter <i>Display drivers</i> updated.</p> <ul style="list-style-type: none"> <li>• <code>GUIDRV_FlexColor</code> supports Sitronix ST7626.</li> </ul> <p>Chapter <i>Memory Devices</i> updated.</p> <ul style="list-style-type: none"> <li>• New function <code>GUI_MEMDEV_GetBitsPerPixel()</code> added.</li> <li>• New function <code>GUI_MEMDEV_GetSelMemdev()</code> added.</li> </ul> <p>Chapter <i>2-D Graphic Library</i> updated.</p> <ul style="list-style-type: none"> <li>• New function <code>GUI_SetAfterExitHook()</code> added.</li> </ul> <p>Chapter <i>Animations</i> updated.</p> <ul style="list-style-type: none"> <li>• New function <code>GUI_ANIM_AddItemById()</code> added.</li> <li>• New function <code>GUI_ANIM_CreateWithId()</code> added.</li> <li>• New function <code>GUI_ANIM_DeleteById()</code> added.</li> <li>• New function <code>GUI_ANIM_Get()</code> added.</li> <li>• New function <code>GUI_ANIM_StartExId()</code> added.</li> <li>• New function <code>GUI_ANIM_StopById()</code> added.</li> </ul> <p>Chapter <i>Configuration</i> updated.</p> <ul style="list-style-type: none"> <li>• New function <code>GUI_SetFuncDrawCircle()</code> added.</li> <li>• New function <code>GUI_SetFuncDrawLine()</code> added.</li> <li>• New function <code>GUI_SetFuncDrawRoundedRect()</code> added.</li> <li>• New function <code>GUI_SetFuncFillCircle()</code> added.</li> <li>• New function <code>GUI_SetFuncFillRoundedRect()</code> added.</li> <li>• Table of currently existing ready to use hardware accelerators added.</li> <li>• Structure of sub chapters changed.</li> </ul> <p>Chapter <i>Widgets (window objects)</i> updated.</p> <ul style="list-style-type: none"> <li>• New function <code>LISTBOX_GetVisItemIndices()</code> added.</li> <li>• New function <code>LISTBOX_IsItemPartiallyVisible()</code> added.</li> <li>• New function <code>KEYBOARD_SetRadius()</code> added.</li> <li>• New function <code>KEYBOARD_SetSpace()</code> added.</li> </ul>

Software	Revision	Date	By	Description
				<ul style="list-style-type: none"> <li>Parameters changed of LISTBOX_EnableMotion(), LISTVIEW_EnableMotion() and MULTIEDIT_EnableMotion(). Calls of previous versions are not affected by this.</li> <li>Added support of the following keys to LISTBOX: GUI_KEY_HOME, GUI_KEY_END, GUI_KEY_PGUP, GUI_KEY_PGDOWN</li> </ul> Chapter 'Viewer' renamed to <i>emWinView</i> . <ul style="list-style-type: none"> <li>emWinView tool rewritten.</li> <li>Added Selection/Measure tool.</li> <li>Keyboard input gets send to emWin application.</li> <li>Transparency is shown for multi-layer configurations.</li> </ul>
6.16	0	201120	FO	Chapter <i>2-D Graphic Library</i> updated. <ul style="list-style-type: none"> <li>New function GUI_CreateBitmapFromStreamRLE1() added.</li> </ul> Chapter <i>Widgets (window objects)</i> updated. <ul style="list-style-type: none"> <li>New function EDIT_GetMinMax() added.</li> <li>New function SPINBOX_GetRange() added.</li> <li>New function TEXT_GetFrameColor() added.</li> <li>New function TEXT_GetDefaultFrameColor() added.</li> <li>New function TEXT_SetFrameColor() added.</li> <li>New function TEXT_SetDefaultFrameColor() added.</li> <li>PROGBAR now sends WM_NOTIFICATION_VALUE_CHANGED to parent when its value has changed.</li> <li>New keyboard layout KEYBOARD_ARA for Arabic added.</li> <li>New function MULTIEDIT_EnableMotion() added.</li> <li>New function MULTIEDIT_SetCursorColor() added.</li> <li>New function MULTIEDIT_SetInvertCursor() added.</li> <li>New function HEADER_SetColumnsResizable() added.</li> <li>New function BUTTON_SetToggleMode() added.</li> <li>New function BUTTON_Toggle() added.</li> <li>BUTTON_REACT_ON_LEVEL is now the default way how PID events are handled by a BUTTON.</li> <li>New function SWIPELIST_SetOverlap() added.</li> <li>New function SWIPELIST_GetOverlap() added.</li> <li>New function SWIPELIST_SetDefaultOverlap() added.</li> <li>New function SWIPELIST_GetDefaultOverlap() added.</li> <li>New function LISTVIEW_GetVisRowIndex() added.</li> <li>New function LISTVIEW_IsRowPartiallyVisible() added.</li> </ul> Chapter <i>Anti-aliasing</i> updated. <ul style="list-style-type: none"> <li>New function GUI_AA_DrawRoundedFrame() added.</li> <li>New function GUI_AA_DrawRoundedFrameEx() added.</li> </ul> Chapter <i>Memory Devices</i> updated. <ul style="list-style-type: none"> <li>New function GUI_MEMDEV_SerializeExBMP() added.</li> <li>Fixed color format issue in GUI_MEMDEV_PunchOutDevice() example.</li> </ul> Chapter <i>AppWizard</i> updated. <ul style="list-style-type: none"> <li>New function APPW_SetCustCallback() added.</li> </ul> Chapter <i>Bitmap Converter</i> updated. <ul style="list-style-type: none"> <li>Reading of C and DTA files added.</li> <li>New bitmap format RLE1 (compressed 1bpp) added.</li> <li>Added section about memory footprint.</li> </ul>
6.14	0	200602	FO	Structure of chapters reworked. Chapter <i>Introduction to emWin</i> updated. <ul style="list-style-type: none"> <li>Added "Complete emWin system" diagram.</li> <li>Example section enhanced.</li> <li>Added information about AppWizard.</li> </ul> Chapter <i>Getting Started</i> updated. <ul style="list-style-type: none"> <li>Prep.bat, CC.bat and Lib.bat examples updated to GCC/Cortex-M4.</li> </ul> Chapter <i>Simulation</i> updated. <ul style="list-style-type: none"> <li>Hardkey bitmap examples updated.</li> </ul> Chapter <i>Fonts</i> updated. <ul style="list-style-type: none"> <li>New function GUI_GetTrailingBlankRows() added.</li> <li>New function GUI_GetLeadingBlankRows() added.</li> </ul> Chapter <i>The Window Manager (WM)</i> updated. <ul style="list-style-type: none"> <li>WM_GetUserData() now returns 0 if the given handle is NULL.</li> </ul> Chapter <i>Widgets (window objects)</i> updated. <ul style="list-style-type: none"> <li>New KEYBOARD widget added.</li> <li>New function KEYBOARD_CreateUser() added.</li> <li>New function KEYBOARD_CreateIndirect() added.</li> <li>New function KEYBOARD_ExportLayout() added.</li> <li>New function KEYBOARD_ExportPatternFile() added.</li> <li>New function KEYBOARD_SetLayout() added.</li> <li>New function KEYBOARD_SetStreamedLayout() added.</li> <li>New function KEYBOARD_SetColor() added.</li> <li>New function KEYBOARD_SetFont() added.</li> </ul>



Software	Revision	Date	By	Description
				<ul style="list-style-type: none"> <li>• New function <code>KEYBOARD_SetPeriod()</code> added.</li> <li>• New function <code>EDIT_EnableAutoScroll()</code> added.</li> </ul>
6.12	1	200417	FO	<p>Chapter <i>Displaying bitmap files</i> updated.</p> <ul style="list-style-type: none"> <li>• Added member <code>Progressive</code> to struct <code>GUI_JPEG_INFO</code> to tell whether or not the JPEG image is progressive. <p>Chapter <i>Anti-aliasing</i> updated.</p> <ul style="list-style-type: none"> <li>• New function <code>GUI_AA_FillEllipseXL()</code> added.</li> </ul> </li></ul>
6.12	0	200408	FO	<p>Chapter <i>2-D Graphic Library</i> updated.</p> <ul style="list-style-type: none"> <li>• New function <code>GUI_QR_CreateFramed()</code> added.</li> </ul> <p>Chapter <i>Widgets (Window objects)</i> updated.</p> <ul style="list-style-type: none"> <li>• New GAUGE widget added.</li> <li>• New function <code>GAUGE_CreateIndirect()</code> added.</li> <li>• New function <code>GAUGE_CreateUser()</code> added.</li> <li>• New function <code>GAUGE_GetValue()</code> added.</li> <li>• New function <code>GAUGE_SetAlign()</code> added.</li> <li>• New function <code>GAUGE_SetBkColor()</code> added.</li> <li>• New function <code>GAUGE_SetColor()</code> added.</li> <li>• New function <code>GAUGE_SetOffset()</code> added.</li> <li>• New function <code>GAUGE_SetRadius()</code> added.</li> <li>• New function <code>GAUGE_SetRange()</code> added.</li> <li>• New function <code>GAUGE_SetRoundedEnd()</code> added.</li> <li>• New function <code>GAUGE_SetRoundedValue()</code> added.</li> <li>• New function <code>GAUGE_SetValue()</code> added.</li> <li>• New function <code>GAUGE_SetValueRange()</code> added.</li> <li>• New function <code>GAUGE_SetWidth()</code> added.</li> <li>• New QRCODE widget added.</li> <li>• New function <code>QRCODE_CreateIndirect()</code> added.</li> <li>• New function <code>QRCODE_CreateUser()</code> added.</li> <li>• New function <code>QRCODE_SetEccLevel()</code> added.</li> <li>• New function <code>QRCODE_SetNumModules()</code> added.</li> <li>• New function <code>QRCODE_SetPixelSize()</code> added.</li> <li>• New function <code>QRCODE_SetText()</code> added.</li> <li>• New function <code>QRCODE_SetWiFiText()</code> added.</li> </ul>
6.10	4	200318	FO	<p>Chapter <i>AppWizard</i> updated.</p> <ul style="list-style-type: none"> <li>• New function <code>APPW_GetFont()</code> added.</li> </ul> <p>Chapter <i>Widgets (window objects)</i> updated.</p> <ul style="list-style-type: none"> <li>• New function <code>RADIO_GetImage()</code> added.</li> <li>• New function <code>LISTVIEW_GetLBorder()</code> added.</li> <li>• New function <code>LISTVIEW_GetRBorder()</code> added.</li> <li>• New function <code>LISTVIEW_GetTextAlign()</code> added.</li> <li>• New function <code>LISTVIEW_RowIsDisabled()</code> added.</li> <li>• New function <code>IMAGE_SetTiled()</code> added.</li> <li>• New function <code>IMAGE_GetImageSize()</code> added.</li> <li>• New function <code>GRAPH_SetGridOffy()</code> added.</li> <li>• New function <code>CHECKBOX_GetDefaultAlign()</code> added.</li> <li>• New function <code>CHECKBOX_SetDefaultAlign()</code> added.</li> <li>• New function <code>CALENDAR_ShowDate()</code> added.</li> <li>• New function <code>CALENDAR_GetWeekday()</code> added.</li> </ul> <p>Chapter <i>Language Support</i> updated.</p> <ul style="list-style-type: none"> <li>• Updated section <i>Thai language support</i>.</li> <li>• New function <code>GUI_UC_EnableThai()</code> added.</li> </ul>
6.10	3	200313	FO	<p>Chapter <i>Displaying Text</i> updated.</p> <ul style="list-style-type: none"> <li>• Added parameter to <code>GUI_GetCharFromPos()</code> to save character index.</li> </ul> <p>Chapter <i>Fonts</i> updated.</p> <ul style="list-style-type: none"> <li>• New function <code>GUI_GetStringDistXEx()</code> added.</li> </ul> <p>Chapter <i>Movies</i> updated.</p> <ul style="list-style-type: none"> <li>• New function <code>GUI_MOVIE_GetInfoH()</code> added.</li> <li>• New function <code>GUI_MOVIE_GetNumFrames()</code> added.</li> </ul> <p>Fixed a bug with <code>GUI_DrawBitmapEx()</code> where transparency wasn't drawn correctly.</p> <p>Chapter <i>Widgets (window objects)</i> updated.</p> <ul style="list-style-type: none"> <li>• Added the functionality of HOME and END keys to EDIT widget.</li> <li>• Added automatic horizontal text scrolling to EDIT widget.</li> <li>• New function <code>TEXT_GetRotation()</code> added.</li> <li>• New function <code>TEXT_SetRotation()</code> added.</li> <li>• New function <code>TEXT_SetDefaultRotation()</code> added.</li> <li>• New function <code>TEXT_GetDefaultRotation()</code> added.</li> <li>• New function <code>TEXT_GetTextOffset()</code> added.</li> <li>• New function <code>TEXT_SetTextOffset()</code> added.</li> </ul>
6.10	2	200218	FO	<p>Chapter <i>Simulation</i> updated.</p> <ul style="list-style-type: none"> <li>• Screenshots updated.</li> </ul>

Software	Revision	Date	By	Description
				<ul style="list-style-type: none"> <li>• <code>SIM_GUI_SetCompositeSize()</code> and <code>SIM_GUI_ShowDevice()</code> enhanced.</li> <li>• Added 'Data structures' section to Device simulation API.</li> <li>• Added 'Defines' section to Device simulation API.</li> </ul> <p>Chapter <i>Viewer</i> updated.</p> <ul style="list-style-type: none"> <li>• Screenshots updated.</li> </ul> <p>Chapter <i>AppWizard</i> updated.</p> <ul style="list-style-type: none"> <li>• Screenshots updated.</li> </ul> <p>Chapter <i>emWinSPY</i> updated.</p> <ul style="list-style-type: none"> <li>• Screenshots updated.</li> </ul> <p>Chapter <i>Displaying text</i> updated.</p> <ul style="list-style-type: none"> <li>• Added 'Defines' section to Text API.</li> <li>• Added 'Enumerations' section to Text API.</li> </ul> <p>Chapter <i>2-D Graphic Library</i> updated.</p> <ul style="list-style-type: none"> <li>• New function <code>GUI_DrawRoundedRectEx()</code> added.</li> <li>• New function <code>GUI_DrawRoundedFrameEx()</code> added.</li> <li>• Added 'Data structures' section to Graphic API.</li> <li>• Added 'Defines' section to Graphic API.</li> </ul> <p>Chapter <i>Displaying bitmap files</i> updated.</p> <ul style="list-style-type: none"> <li>• Added 'Data structures' section to JPEG API.</li> <li>• Added 'Data structures' section to GIF API.</li> </ul> <p>Chapter <i>Bitmap Converter</i> updated.</p> <ul style="list-style-type: none"> <li>• Screenshots updated.</li> </ul> <p>Chapter <i>Language Support</i> updated.</p> <ul style="list-style-type: none"> <li>• References to BiDi removed even if emWin is compiled with <code>GUI_SUPPORT_BIDI</code>. Calling of <code>GUI_UC_EnableBIDI()</code> now is mandatory.</li> </ul> <p>Chapter <i>Fonts</i> updated.</p> <ul style="list-style-type: none"> <li>• Added 'Data structures' section to Font API.</li> <li>• Added 'Defines' section to Font API.</li> </ul> <p>Chapter <i>Font Converter</i> updated.</p> <ul style="list-style-type: none"> <li>• Screenshots updated.</li> </ul> <p>Chapter <i>Movies</i> updated.</p> <ul style="list-style-type: none"> <li>• Screenshot updated.</li> <li>• Added 'Data structures' section to Movie API.</li> <li>• Added 'Defines' section to Movie API.</li> </ul> <p>Chapter <i>Animations</i> updated.</p> <ul style="list-style-type: none"> <li>• Added section <i>Using a delete callback function</i>.</li> <li>• Added 'Data structures' section to Animation API.</li> <li>• Added 'Defines' section to Animation API.</li> </ul> <p>Chapter <i>Colors</i> updated.</p> <ul style="list-style-type: none"> <li>• Screenshot updated.</li> </ul> <p>Chapter <i>Memory Devices</i></p> <ul style="list-style-type: none"> <li>• Added 'Defines' section to Memory Device API.</li> </ul> <p>Chapter <i>The Window Manager (WM)</i> updated.</p> <ul style="list-style-type: none"> <li>• Added 'Data structures' section to WM API.</li> <li>• Added 'Defines' section to WM API.</li> </ul> <p>Chapter <i>Widgets (window objects)</i> updated.</p> <ul style="list-style-type: none"> <li>• Added 'Defines' section to BUTTON API.</li> <li>• Added 'Defines' section to CHECKBOX API.</li> <li>• Added 'Defines' section to DROPDOWN API.</li> <li>• Added 'Defines' section to EDIT API.</li> <li>• Added 'Defines' section to FRAMEWIN API.</li> <li>• Added 'Defines' section to GRAPH API.</li> <li>• New function <code>GRAPH_DATA_XY_Clear()</code> added.</li> <li>• New function <code>GRAPH_DATA_XY_GetLineVis()</code> added.</li> <li>• New function <code>GRAPH_DATA_XY_GetPointVis()</code> added.</li> <li>• New function <code>GRAPH_DATA_XY_SetLineVis()</code> added.</li> <li>• New function <code>GRAPH_DATA_XY_SetPointVis()</code> added.</li> <li>• New function <code>HEADER_DeleteItem()</code> added.</li> <li>• New function <code>HEADER_GetSel()</code> added.</li> <li>• New function <code>HEADER_SetFixed()</code> added.</li> <li>• New function <code>HEADER_SetScrollPos()</code> added.</li> <li>• Added 'Defines' section to ICONVIEW API.</li> <li>• Added 'Defines' section to IMAGE API.</li> <li>• Added 'Defines' section to LISTBOX API.</li> <li>• Added 'Defines' section to LISTVIEW API.</li> <li>• Added 'Defines' section to LISTWHEEL API.</li> <li>• Added 'Data structures' section to MENU API.</li> <li>• Added 'Defines' section to MENU API.</li> <li>• Added 'Defines' section to MULTIEDIT API.</li> <li>• Added 'Defines' section to MULTIPAGE API.</li> <li>• Added 'Defines' section to RADIO API.</li> <li>• New function <code>RADIO_GetNumItems()</code> added.</li> <li>• New function <code>RADIO_GetSpacing()</code> added.</li> </ul>

Software	Revision	Date	By	Description
				<ul style="list-style-type: none"> <li>• New function <code>RADIO_SetSpacing()</code> added.</li> <li>• Added 'Defines' section to <code>SCROLLBAR</code> API.</li> <li>• Added 'Defines' section to <code>SLIDER</code> API.</li> <li>• Added 'Defines' section to <code>SPINBOX</code> API.</li> <li>• Added 'Defines' section to <code>SWIPELIST</code> API.</li> <li>• Added 'Defines' section to <code>SWITCH</code> API.</li> </ul> <p>Chapter <i>Dialogs</i> updated.</p> <ul style="list-style-type: none"> <li>• Added 'Data structures' section to <code>CALENDAR</code> API.</li> <li>• Added 'Defines' section to <code>CALENDAR</code> API.</li> <li>• Added 'Defines' section to <code>CHOOSECOLOR</code> API.</li> <li>• Added 'Data structures' section to <code>CHOOSEFILE</code> API.</li> <li>• Added 'Defines' section to <code>CHOOSEFILE</code> API.</li> </ul> <p>Chapter <i>MultiLayer / MultiDisplay support</i> updated.</p> <ul style="list-style-type: none"> <li>• Added 'Data structures' section to <code>MultiLayer</code> API.</li> </ul> <p>Chapter <i>MultiTouch support (MT)</i> updated.</p> <ul style="list-style-type: none"> <li>• Added 'Data structures' section to <code>Basic buffer access</code> API.</li> <li>• Added 'Defines' section to <code>Basic buffer access</code> API.</li> </ul> <p>Chapter <i>Cursors</i> updated.</p> <ul style="list-style-type: none"> <li>• Added 'Data structures' section to <code>Cursor</code> API.</li> </ul> <p>Chapter <i>VNC Server</i> updated.</p> <ul style="list-style-type: none"> <li>• Added 'Data structures' section to <code>VNC Server</code> API.</li> </ul> <p>Chapter <i>Indexes</i> updated.</p> <ul style="list-style-type: none"> <li>• Added 'Types' index for data structures.</li> </ul>
6.10	1	200203	JE	<p>Chapter <i>Display drivers</i> updated.</p> <ul style="list-style-type: none"> <li>• <code>GUIDRV_SPage</code> supports <code>Sitronix ST7571</code>, <code>GUIDRV_SPage_Set1510()</code></li> </ul>
6.10	0	200106	FO	<p>New chapter <i>AppWizard</i>.</p> <ul style="list-style-type: none"> <li>• New function <code>APPW_SetVarData()</code> added.</li> <li>• New function <code>APPW_GetVarData()</code> added.</li> </ul> <p>Chapter <i>Displaying Text</i> updated.</p> <ul style="list-style-type: none"> <li>• New function <code>GUI_GetCharFromPos()</code> added.</li> </ul> <p>Chapter <i>2-D Graphic Library</i> updated.</p> <ul style="list-style-type: none"> <li>• New function <code>GUI_BARCODE_Draw()</code> added.</li> <li>• New function <code>GUI_BARCODE_GetXSize()</code> added.</li> <li>• New function <code>GUI_DrawGradientVEx()</code> added.</li> <li>• New function <code>GUI_DrawGradientHEX()</code> added.</li> <li>• New function <code>GUI_DrawGradientMVEEx()</code> added.</li> <li>• New function <code>GUI_DrawGradientMHEX()</code> added.</li> <li>• New function <code>GUI_DrawGradientRoundedVEx()</code> added.</li> <li>• New function <code>GUI_DrawGradientRoundedHEX()</code> added.</li> <li>• New function <code>GUI_FillRoundedRectEx()</code> added.</li> <li>• New function <code>GUI_YUV_Create()</code> added.</li> <li>• New function <code>GUI_YUV_CreateEx()</code> added.</li> <li>• New function <code>GUI_YUV_Delete()</code> added.</li> <li>• New function <code>GUI_YUV_DeleteEx()</code> added.</li> <li>• New function <code>GUI_YUV_GetpData()</code> added.</li> <li>• New function <code>GUI_YUV_GetpDataEx()</code> added.</li> <li>• New function <code>GUI_YUV_InvalidArea()</code> added.</li> <li>• New function <code>GUI_YUV_SetPeriodEx()</code> added.</li> <li>• New function <code>GUI_YUV_SetPeriod()</code> added.</li> </ul> <p>Chapter <i>Animations</i> updated.</p> <ul style="list-style-type: none"> <li>• New function <code>GUI_ANIM_DeleteAll()</code> added.</li> <li>• New function <code>GUI_ANIM_GetFirst()</code> added.</li> <li>• New function <code>GUI_ANIM_GetNext()</code> added.</li> <li>• New function <code>GUI_ANIM_GetData()</code> added.</li> <li>• New function <code>GUI_ANIM_IsRunning()</code> added.</li> <li>• New function <code>GUI_ANIM_GetNumItems()</code> added.</li> <li>• New function <code>GUI_ANIM_GetItemData()</code> added.</li> </ul> <p>Chapter <i>Widgets (window objects)</i> updated.</p> <ul style="list-style-type: none"> <li>• New <code>ROTARY</code> widget added.</li> <li>• New <code>SWITCH</code> widget added.</li> <li>• New function <code>EDIT_GetCharAtPixel()</code> added.</li> <li>• New function <code>EDIT_GetSel()</code> added.</li> <li>• New function <code>EDIT_GetSelText()</code> added.</li> <li>• New function <code>GRAPH_DATA_YT_SetColor()</code> added.</li> <li>• New function <code>GRAPH_DATA_XY_SetColor()</code> added.</li> <li>• New function <code>HEADER_GetColumnFromPos()</code> added.</li> <li>• New function <code>LISTBOX_EnableMotion()</code> added.</li> <li>• New function <code>LISTVIEW_EnableMotion()</code> added.</li> <li>• New function <code>MULTIEDIT_GetNumChars()</code> added.</li> <li>• New function <code>MULTIPAGE_GetTabHeight()</code> added.</li> <li>• New function <code>MULTIPAGE_GetTabWidth()</code> added.</li> <li>• New function <code>MULTIPAGE_GetNumTabs()</code> added.</li> </ul>

Software	Revision	Date	By	Description
				<ul style="list-style-type: none"> <li>• New function SWIPELIST_IsSepItem() added.</li> <li>• Fixed a bug with the LISTVIEW widget where column headers would not move in fixed mode.</li> <li>• Fixed a bug with LISTWHEEL_SetItemData() that would cause a crash.</li> <li>• Fixed a bug where if SKINFLEX_PROPS where set only for the SPINBOX_SKINFLEX_PI_FOCUSED state, the lower button wasn't drawn correctly.</li> <li>• Fixed a bug where if DROPDOWN was collapsed it was possible to select disabled item by keyboard.</li> <li>• Fixed a bug where some widgets in a MULTIPAGE widget wouldn't get the focus.</li> </ul> Chapter <i>Sprites</i> updated. <ul style="list-style-type: none"> <li>• Fixed a bug where sprites weren't working with 1bpp bitmaps.</li> </ul> Chapter <i>Anti-aliasing</i> updated. <ul style="list-style-type: none"> <li>• Fixed a bug where GUI_AA_DrawLine() didn't draw a line in a window properly, added missing WM_ADDORG(x1, y1).</li> </ul> Chapter <i>Display drivers</i> updated. <ul style="list-style-type: none"> <li>• GUIDRV_FlexColor supports UC1698, GUIDRV_FlexColor_Func66725</li> </ul> Chapter <i>VNC Server</i> updated. <ul style="list-style-type: none"> <li>• emVNC is now available for MacOS and Linux.</li> <li>• New functions such as managing last connections, zooming in and out and fullscreen mode.</li> </ul>
5.50	1	191015	FO	Various corrections and improvements.
5.50	0	190528	SC	Chapter <i>Displaying Text</i> updated. <ul style="list-style-type: none"> <li>• New function GUI_ShowMissingCharacters() added.</li> </ul> Chapter <i>2-D Graphic Library</i> updated. <ul style="list-style-type: none"> <li>• New function GUI_DrawGradientMH() added.</li> <li>• New function GUI_DrawGradientMV() added.</li> </ul> Chapter <i>Memory Devices</i> updated. <ul style="list-style-type: none"> <li>• New function GUI_MEMDEV_CreateCopy() added.</li> </ul> Chapter <i>The Window Manager (WM)</i> updated. <ul style="list-style-type: none"> <li>• New function WM_SetUntouchable() added.</li> </ul> Chapter <i>Widgets (window objects)</i> updated. <ul style="list-style-type: none"> <li>• New function GRAPH_InvertScrollBar() added.</li> <li>• New function GRAPH_DATA_YT/XY_SetColor() added.</li> <li>• New function KNOB_SetInvert() added.</li> <li>• New function KNOB_SetRotateHQ() added.</li> <li>• New function KNOB_SetRotateLQ() added.</li> <li>• New function SLIDER_EnableFocusRect() added.</li> <li>• New function SLIDER_SetInvertDir() added.</li> <li>• New function SPINBOX_SetTimerPeriod() added.</li> </ul> Chapter <i>Display drivers</i> updated. <ul style="list-style-type: none"> <li>• New driver GUIDRV_SLinEPD added.</li> <li>• New driver GUIDRV_SSD1322 added.</li> </ul> Chapter <i>Configuration</i> updated. <ul style="list-style-type: none"> <li>• New function GUI_AlphaEnableFillRectHW() added.</li> </ul>
5.48	0	180611	SC	Chapter <i>Displaying Text</i> updated. <ul style="list-style-type: none"> <li>• New function GUI_SetClearTextRectMode() added.</li> </ul> Chapter <i>The Window Manager (WM)</i> updated. <ul style="list-style-type: none"> <li>• New function WM_Rect2Screen() added.</li> <li>• New function WM_Rect2Client() added.</li> <li>• New function WM_XY2Screen() added.</li> <li>• New function WM_XY2Client() added.</li> </ul> Chapter <i>Widgets (window objects)</i> updated. <ul style="list-style-type: none"> <li>• New function LISTBOX_SetFixedScrollPos() added.</li> </ul> Chapter <i>Language Support</i> updated. <ul style="list-style-type: none"> <li>• New function GUI_UC_SetEncodeSJIS() added.</li> </ul> Chapter <i>Display drivers</i> updated. <ul style="list-style-type: none"> <li>• New function GUIDRV_FlexColor_SetOrientation() added.</li> <li>• New function GUIDRV_s1D13781_SetOrientation() added.</li> <li>• New function GUIDRV_s1D13L01_SetOrientation() added.</li> <li>• New function LCD_Refresh() added.</li> <li>• New function LCD_RefreshEx() added.</li> <li>• New function LCD_ROTATE_AddDriver() added.</li> <li>• New function LCD_ROTATE_AddDriverEx() added.</li> <li>• New function LCD_ROTATE_DecSel() added.</li> <li>• New function LCD_ROTATE_DecSelEx() added.</li> <li>• New function LCD_ROTATE_IncSel() added.</li> <li>• New function LCD_ROTATE_IncSelEx() added.</li> <li>• New function LCD_ROTATE_SetCallback() added.</li> <li>• New function LCD_ROTATE_SetSel() added.</li> <li>• New function LCD_ROTATE_SetSelEx() added.</li> </ul>

Software	Revision	Date	By	Description
				<ul style="list-style-type: none"> <li>• GUIDRV_FlexColor support for SSD1353 added.</li> </ul> Chapter <i>Configuration</i> updated. <ul style="list-style-type: none"> <li>• New function GUI_ALLOC_GetMemInfo() added.</li> <li>• New function GUI_AA_SetFuncFillCircle() added.</li> <li>• New function GUI_AA_SetFuncFillPolygon() added.</li> <li>• New function GUI_AA_SetFuncDrawCircle() added.</li> <li>• New function GUI_AA_SetFuncDrawLine() added.</li> <li>• New function GUI_AA_SetFuncDrawPolyOutline() added.</li> <li>• New function GUI_AA_SetFuncDrawArc() added.</li> <li>• New function GUI_AA_SetpfStrcmp() added.</li> <li>• New function GUI_AA_SetpfStrcpy() added.</li> <li>• New function GUI_AA_SetpfStrlen() added.</li> </ul>
5.46	0	171212	SC	Chapter <i>Introduction to emWin</i> updated. <ul style="list-style-type: none"> <li>• Support of 64 bit data models added.</li> </ul> Chapter <i>Bitmap Converter</i> updated. <ul style="list-style-type: none"> <li>• Description of DTA files added.</li> </ul> Chapter <i>The Window Manager (WM)</i> updated. <ul style="list-style-type: none"> <li>• New message WM_SET_CALLBACK added.</li> <li>• Desktop window (WM_HBKWIN) is able to get user data now.</li> </ul> Chapter <i>Widgets (window objects)</i> updated. <ul style="list-style-type: none"> <li>• New function CHECKBOX_GetImage() added.</li> <li>• New function HEADER_GetItemText() added.</li> </ul> Chapter <i>Display drivers</i> updated. <ul style="list-style-type: none"> <li>• New function LCD_GetVRAMAddr() added.</li> <li>• New function LCD_GetVRAMAddrEx() added.</li> <li>• GUIDRV_FlexColor support for HX8367 added.</li> <li>• GUIDRV_SPage support for UC1628 added.</li> <li>• GUIDRV_SPage support for ST75320 added.</li> <li>• GUIDRV_SPage support for SSD1309 added.</li> </ul> Chapter <i>Timing- and execution-related functions</i> updated. <ul style="list-style-type: none"> <li>• renamed GUI_Error() to GUI_ErrorOut().</li> </ul>
5.44	1	171115	SC	Fixed table description.
5.44	0	171020	SC	Chapter <i>emWin SPY</i> updated. <ul style="list-style-type: none"> <li>• New function GUI_SPY_StartServerEx() added.</li> </ul> Chapter <i>2-D Graphic Library</i> updated. <ul style="list-style-type: none"> <li>• New function GUI_SPLINE_Create() added.</li> <li>• New function GUI_SPLINE_Draw() added.</li> <li>• New function GUI_SPLINE_Delete() added.</li> <li>• New function GUI_SPLINE_GetY() added.</li> <li>• New function GUI_SPLINE_GetXSize() added.</li> <li>• New function GUI_SPLINE_DrawAA() added.</li> </ul> Chapter <i>Displaying bitmap files</i> updated. <ul style="list-style-type: none"> <li>• New function GUI_JPEG_SetpfDrawEx() added.</li> </ul> Chapter <i>Movies</i> updated. <ul style="list-style-type: none"> <li>• New function GUI_MOVIE_SetpfNotify() added.</li> <li>• New functionality of displaying AVI files added.</li> </ul> Chapter <i>The Window Manager (WM)</i> updated. <ul style="list-style-type: none"> <li>• New message WM_USER_DATA added.</li> </ul> Chapter <i>Widgets (window objects)</i> updated. <ul style="list-style-type: none"> <li>• New function EDIT_GetTextAlign() added.</li> </ul> Chapter <i>Anti-aliasing</i> updated. <ul style="list-style-type: none"> <li>• New function GUI_AA_DrawCircle() added.</li> </ul> Chapter <i>Display drivers</i> updated. <ul style="list-style-type: none"> <li>• New driver GUIDRV_SH_MEM_3 added.</li> <li>• GUIDRV_FlexColor support for ST7775 added.</li> <li>• New function GUIDRV_SPage_SetUC1610() added.</li> <li>• GUIDRV_1611 removed, covered by GUIDRV_SPage.</li> </ul> Chapter <i>Configuration</i> updated. <ul style="list-style-type: none"> <li>• New function GUI_ALLOC_GetMaxUsedBytes() added.</li> <li>• New function GUI_RegisterAfterInitHook() added.</li> <li>• New functionality, interface for JPEG hardware support.</li> </ul>
5.42	0	170731	SC	Chapter <i>Displaying Text</i> updated. <ul style="list-style-type: none"> <li>• New function GUI_DispStringInRectWrapEx() added.</li> <li>• New function GUI_SetStrikeWidth() added.</li> </ul> Chapter <i>2-D Graphic Library</i> updated. <ul style="list-style-type: none"> <li>• New function GUI_AddRect() added.</li> </ul> Chapter <i>Bitmap Converter</i> updated. <ul style="list-style-type: none"> <li>• Description about options dialog</li> </ul> Chapter <i>Widgets (window objects)</i> updated. <ul style="list-style-type: none"> <li>• New function CHECKBOX_GetBkColor() added.</li> <li>• New function CHECKBOX_GetBoxBkColor() added.</li> </ul>

Software	Revision	Date	By	Description
				<ul style="list-style-type: none"> <li>• New function CHECKBOX_GetFocusColor() added.</li> <li>• New function CHECKBOX_GetFont() added.</li> <li>• New function CHECKBOX_GetTextAlign() added.</li> <li>• New function CHECKBOX_GetTextColor() added.</li> <li>• New function DROPDOWN_GetBkColor() added.</li> <li>• New function DROPDOWN_GetColor() added.</li> <li>• New function DROPDOWN_GetFont() added.</li> <li>• New function DROPDOWN_GetTextColor() added.</li> <li>• New function GRAPH_GetColor() added.</li> <li>• New function HEADER_GetFont() added.</li> <li>• New function ICONVIEW_GetBkColor() added.</li> <li>• New function ICONVIEW_GetFont() added.</li> <li>• New function ICONVIEW_GetTextColor() added.</li> <li>• New function ICONVIEW_GetReleasedItem() added.</li> <li>• New function LISTBOX_GetBkColor() added.</li> <li>• New function LISTBOX_GetTextColor() added.</li> <li>• New function MENU_GetBkColor() added.</li> <li>• New function MENU_GetFont() added.</li> <li>• New function MENU_GetTextColor() added.</li> <li>• New function MULTIEDIT_GetBkColor() added.</li> <li>• New function MULTIEDIT_GetFont() added.</li> <li>• New function MULTIEDIT_GetTextColor() added.</li> <li>• New function MULTIEDIT_ShowCursor() added.</li> <li>• New function MULTIPAGE_GetBkColor() added.</li> <li>• New function MULTIPAGE_GetTextColor() added.</li> <li>• New function PROGBAR_GetBarColor() added.</li> <li>• New function PROGBAR_GetFont() added.</li> <li>• New function RADIO_GetBkColor() added.</li> <li>• New function RADIO_GetFocusColor() added.</li> <li>• New function RADIO_GetFont() added.</li> <li>• New function RADIO_GetTextColor() added.</li> <li>• New function SCROLLBAR_GetColor() added.</li> <li>• New function SPINBOX_GetFont() added.</li> <li>• New function SPINBOX_GetTextColor() added.</li> <li>• New function TEXT_SetDec() added.</li> </ul> <p>Chapter <i>Dialogs</i> updated.</p> <ul style="list-style-type: none"> <li>• New function CALENDAR_AddKey() added.</li> </ul> <p>Chapter <i>Display drivers</i> updated.</p> <ul style="list-style-type: none"> <li>• 16bpp support for GUIDRV_S1D13L01 added.</li> <li>• 16bpp support for GUIDRV_S1D13781 added.</li> <li>• New function LCD_SetBufferPtr() added.</li> <li>• New function LCD_SetBufferPtrEx() added.</li> </ul>
5.40	2	170524	JE	<p>Chapter <i>Displaying bitmap files</i> updated.</p> <ul style="list-style-type: none"> <li>• Download link to PNG library changed.</li> </ul> <p>Chapter <i>Fonts</i> updated.</p> <ul style="list-style-type: none"> <li>• Download link to iType and iTypeSpark glue code changed.</li> <li>• Download link to Freetype library changed.</li> <li>• Description of XBF format added.</li> </ul>
5.40	1	170508	JE	<p>Chapter <i>Display drivers</i> updated.</p> <ul style="list-style-type: none"> <li>• New driver GUIDRV_S1D13L01 added</li> <li>• New driver GUIDRV_S1D13L02 added</li> <li>• New driver GUIDRV_S1D13L04 added</li> </ul>
5.40	0	170302	JE	<p>Chapter <i>Simulation</i> updated.</p> <ul style="list-style-type: none"> <li>• Function SIM_GUI_SaveCompositeBMP() added.</li> </ul> <p>Chapter <i>Displaying Text</i> updated.</p> <ul style="list-style-type: none"> <li>• Function GUI_WrapSetSeparators() added.</li> <li>• Function GUI_WrapGetPositions() added.</li> </ul> <p>Chapter <i>Movies</i> updated.</p> <ul style="list-style-type: none"> <li>• Function GUI_MOVIE_DrawFrame() added.</li> </ul> <p>Chapter <i>Widgets (window objects)</i> updated.</p> <ul style="list-style-type: none"> <li>• Function ICONVIEW_GetItemBitmap() added.</li> <li>• Function ICONVIEW_SetOwnerDraw() added.</li> <li>• Function MULTIEDIT_SetCursorCharPos() added.</li> <li>• Function MULTIEDIT_SetCursorPixelPos() added.</li> <li>• Function WIDGET_SetFocusable() added.</li> <li>• Function WIDGET_EnableStreamAuto() added.</li> </ul> <p>Chapter <i>Bitmap Converter</i> updated.</p> <ul style="list-style-type: none"> <li>• Bitmap Converter now supports JPEG files.</li> <li>• New command line option 'reducecolors' added.</li> <li>• New command line option 'hide' added.</li> <li>• New command line option 'scale' added.</li> </ul> <p>Chapter <i>The Window Manager (WM)</i> updated.</p>

Software	Revision	Date	By	Description
				<ul style="list-style-type: none"> <li>Function WM_GetNumInvalidWindows() added.</li> <li>Function WM_MOTION_SetThreshold() added.</li> <li>'Overlapping' support added to WM_MOTION.</li> <li>New variables added to WM_MOTION_INFO.</li> </ul> Chapter <i>Display drivers</i> updated. <ul style="list-style-type: none"> <li>Function LCD_On() and LCD_OnEx() added.</li> <li>Function LCD_Off() and LCD_OffEx() added.</li> </ul> Chapter <i>Configuration</i> updated. <ul style="list-style-type: none"> <li>Function GUI_SetpfMemset() added.</li> <li>Function GUI_SetpfMemcpy() added.</li> </ul>
5.38	0	161124	JE SC	Chapter <i>Simulation</i> updated. <ul style="list-style-type: none"> <li>Function SIM_GUI_Delay() added.</li> <li>Function SIM_GUI_ExecIdle() added.</li> <li>Function SIM_GUI_GetTime() added.</li> </ul> Chapter <i>2-D Graphic Library</i> updated. <ul style="list-style-type: none"> <li>Function GUI_GCACHE_4_Create() added.</li> <li>Function GUI_GCACHE_4_CreateEx() added.</li> </ul> Chapter <i>Fonts</i> updated. <ul style="list-style-type: none"> <li>Function GUI_GetDefaultFont() added.</li> </ul> Chapter <i>Animations</i> updated. <ul style="list-style-type: none"> <li>Function GUI_ANIM_StartEx() added.</li> <li>Function GUI_ANIM_Stop() added.</li> </ul> Chapter <i>Colors</i> updated. <ul style="list-style-type: none"> <li>Function GUI_GetDefaultBkColor() added.</li> <li>Function GUI_GetDefaultColor() added.</li> <li>Function GUI_SetDefaultBkColor() added.</li> <li>Function GUI_SetDefaultColor() added.</li> </ul> Chapter <i>Memory Devices</i> updated. <ul style="list-style-type: none"> <li>Function GUI_MEMDEV_MULTIBUF_Enable() added.</li> </ul> Chapter <i>The Window Manager (WM)</i> updated. <ul style="list-style-type: none"> <li>Explanation how to work with WM and multiple layers added.</li> </ul> Chapter <i>Widgets (window objects)</i> updated. <ul style="list-style-type: none"> <li>MULTIEDIT: GUI_KEY_PGUP and GUI_KEY_PGDOWN added</li> </ul> Chapter <i>Pointer Input Devices</i> updated. <ul style="list-style-type: none"> <li>Function GUI_PID_SetHook() added.</li> </ul> Chapter <i>Display drivers</i> updated. <ul style="list-style-type: none"> <li>LCD_DEVFUNC_DRAWBMP_32BPP added to LCD_SetDevFunc().</li> <li>New driver GUIDRV_S1D13513 added.</li> <li>GUIDRV_FlexColor: 24bpp mode added to F66720.</li> </ul> Chapter <i>VNC Server</i> updated. <ul style="list-style-type: none"> <li>Function GUI_VNC_SetRetryCount() added.</li> </ul> Chapter <i>Timing and execution related functions</i> updated. <ul style="list-style-type: none"> <li>Function GUI_GetTimeSlice() added.</li> <li>Function GUI_SetTimeSlice() added.</li> </ul> Chapter <i>Configuration</i> updated. <ul style="list-style-type: none"> <li>Explanation added how to work with a frame buffer and DCACHE</li> <li>Function GUI_SetFuncDrawAlpha() added.</li> <li>Function GUI_DCACHE_Clear() added.</li> <li>Function GUI_DCACHE_SetClearCacheHook() added.</li> </ul>
5.36	2	160906	JE	Chapter <i>Performance and Resource usage</i> updated. <ul style="list-style-type: none"> <li>Performance values for ARM Cortex-M4 and A9 added</li> <li>Image performance values recalculated</li> </ul>
5.36	1	160901	JE	Chapter <i>Display drivers</i> updated. <ul style="list-style-type: none"> <li>GUIDRV_FlexColor: 24bpp mode added</li> </ul>
5.36	0	160829	JE	Chapter <i>Widgets (window objects)</i> updated. <ul style="list-style-type: none"> <li>Function SWIPELIST_GetThreshold() added.</li> <li>Function SWIPELIST_SetThreshold() added.</li> <li>Function SWIPELIST_SetDefaultThreshold() added.</li> <li>Function SWIPELIST_GetDefaultThreshold() added.</li> <li>Function GRAPH_DATA_YT_GetValue() added.</li> <li>Function GRAPH_DATA_XY_GetPoint() added.</li> </ul> Chapter <i>Anti-aliasing</i> updated. <ul style="list-style-type: none"> <li>Function GUI_AA_EnableGammaAA4() added.</li> <li>Function GUI_AA_SetGammaAA4() added.</li> <li>Function GUI_AA_GetGammaAA4() added.</li> </ul> Chapter <i>Language Support</i> updated. <ul style="list-style-type: none"> <li>Explanation of Unicode standard compatibility added.</li> <li>Function GUI_UC_SetBaseDir() added.</li> </ul> Chapter <i>Display drivers</i> updated. <ul style="list-style-type: none"> <li>Support for Sitronix ST7796 added to GUIDRV_FlexColor.</li> <li>Support for LDT LD7138 added to GUIDRV_FlexColor.</li> </ul>

Software	Revision	Date	By	Description
				<ul style="list-style-type: none"> <li>Support for SP9230 added to GUIDRV_FlexColor.</li> <li>Support for IST3501 added to GUIDRV_SPage.</li> <li>Support for Sitronix ST7570 added to GUIDRV_SPage.</li> </ul>
5.34	2	160621	JE	Chapter <i>Introduction</i> updated. <ul style="list-style-type: none"> <li>Compiler limitation added: 'char' needs to be 8 bit</li> </ul>
5.34	1	160517	JE	Chapter <i>Display drivers</i> updated. <ul style="list-style-type: none"> <li>GUIDRV_SH_MEM: LS013B7DH06 removed, only b/w supported</li> </ul>
5.34	0	160425	JE	Chapter <i>Getting Started</i> updated. <ul style="list-style-type: none"> <li>Function GUI_IsInitialized() added.</li> </ul> Chapter <i>Simulation</i> updated. <ul style="list-style-type: none"> <li>Function SIM_GUI_SaveBMP() added.</li> <li>Function SIM_GUI_SaveBMPEX added.</li> </ul> Chapter <i>2-D Graphic Library</i> updated. <ul style="list-style-type: none"> <li>Function GUI_QR_Create() added.</li> <li>Function GUI_QR_Delete() added.</li> <li>Function GUI_QR_Draw() added.</li> <li>Function GUI_QR_GetInfo() added.</li> <li>Function GUI_SetControlHook() added.</li> </ul> Chapter <i>Displaying bitmap files</i> updated. <ul style="list-style-type: none"> <li>Function GUI_BMP_EnableAlpha() added.</li> </ul> Chapter <i>Fonts</i> updated. <ul style="list-style-type: none"> <li>Support for iTypeSpark® font engine added.</li> </ul> Chapter <i>Widgets (window objects)</i> updated. <ul style="list-style-type: none"> <li>Function LISTBOX_GetOwner() added.</li> </ul> Chapter <i>Pointer Input Devices</i> updated. <ul style="list-style-type: none"> <li>Function GUI_PID_SetInitFunc() added.</li> </ul> Chapter <i>Display drivers</i> updated. <ul style="list-style-type: none"> <li>New display driver for Sharp Memory LCDs added</li> </ul> Chapter <i>VNC Server</i> updated. <ul style="list-style-type: none"> <li>File transfer capabilities added.</li> </ul> Chapter <i>Configuration</i> updated. <ul style="list-style-type: none"> <li>Macro GUI_POST_INIT added.</li> </ul>
5.32	0	150930	JE	Chapter <i>Simulation</i> updated. <ul style="list-style-type: none"> <li>Function SIM_GUI_GetCompositeTouch() added.</li> <li>Function SIM_GUI_SetCompositeTouch() added.</li> </ul> Chapter <i>emWinSPY</i> updated. <ul style="list-style-type: none"> <li>RTT connection added.</li> </ul> Chapter <i>Widgets (window objects)</i> updated. <ul style="list-style-type: none"> <li>New widget 'SWIPELIST' added.</li> <li>Function LISTVIEW_SetSelCol() added.</li> <li>Function SLIDER_GetRange() added.</li> <li>Function EDIT_EnableInversion() added.</li> </ul> Chapter <i>Language Support</i> updated. <ul style="list-style-type: none"> <li>Function GUI_LANG_GetLang() added.</li> </ul> Chapter <i>Display drivers</i> updated. <ul style="list-style-type: none"> <li>Commands added to LCD_X_DisplayDriver(): LCD_X_SHOWBUFFER, LCD_X_SETVIS, LCD_X_SETPOS, LCD_X_SETSIZE, LCD_X_SETALPHA</li> </ul>
5.30	0	150706	JE AS	Chapter <i>2-D Graphic Library</i> updated. <ul style="list-style-type: none"> <li>Function GUI_PreserveTrans() added.</li> <li>Function GUI_SetAlphaMask8888() added.</li> </ul> Chapter <i>Bitmap Converter</i> updated. <ul style="list-style-type: none"> <li>Saving of PNGs now supported.</li> <li>New bitmap format M8888I supported.</li> </ul> Chapter <i>Font Converter</i> updated. <ul style="list-style-type: none"> <li>Loading of Adobe (B)itmap (D)istribution (F)ormat (BDF) added.</li> </ul> Chapter <i>Animations</i> updated. <ul style="list-style-type: none"> <li>Function GUI_ANIM_AddItem() added.</li> <li>Function GUI_ANIM_Create() added.</li> <li>Function GUI_ANIM_Delete() added.</li> <li>Function GUI_ANIM_Exec() added.</li> <li>Function GUI_ANIM_Start() added.</li> </ul> Chapter <i>Colors</i> updated. <ul style="list-style-type: none"> <li>New logical color mode ARGB added.</li> </ul> Chapter <i>Memory Devices</i> updated. <ul style="list-style-type: none"> <li>Function GUI_MEMDEV_WriteOpaque() added.</li> <li>Function GUI_MEMDEV_WriteOpaqueAt() added.</li> </ul> Chapter <i>The Window Manager (WM)</i> updated. <ul style="list-style-type: none"> <li>Explanation of tiling algorithm added.</li> </ul> Chapter <i>Widgets (window objects)</i> updated. <ul style="list-style-type: none"> <li>Function LISTWHEEL_IsMoving() added.</li> </ul>



Software	Revision	Date	By	Description
				<ul style="list-style-type: none"> <li>Function <code>PROGBAR_GetMinMax()</code> added.</li> <li>Function <code>PROGBAR_GetValue()</code> added.</li> <li>Function <code>TEXT_GetBkColor()</code> added.</li> <li>Function <code>TEXT_GetFont()</code> added.</li> <li>Function <code>TEXT_GetTextAlign()</code> added.</li> <li>Function <code>TEXT_GetTextColor()</code> added.</li> <li>Function <code>TEXT_GetWrapMode()</code> added.</li> <li>Function <code>TEXT_GetDefaultTextColor()</code> added.</li> <li>Function <code>TEXT_GetDefaultWrapMode()</code> added.</li> </ul> Chapter <i>Display drivers</i> updated. <ul style="list-style-type: none"> <li>Support for HX8369 added to <code>GUIDRV_FlexColor</code>.</li> <li>Support for ST7715 added to <code>GUIDRV_FlexColor</code>.</li> <li>Support for SSD1325 added to <code>GUIDRV_SLin</code>.</li> </ul>
5.28	1	150206	JE	Licensing information of TTF and PNG support changed.
5.28	0	150128	JE AS	Chapter <i>Simulation</i> updated. <ul style="list-style-type: none"> <li>Function <code>SIM_GUI_SetTransMode()</code> added.</li> </ul> New Chapter <i>emWinSPY</i> updated. <ul style="list-style-type: none"> <li>New tool <code>emWinSPY</code> added:</li> <li>Function <code>GUI_SPY_Process()</code> added.</li> <li>Function <code>GUI_SPY_SetMemHandler()</code> added.</li> <li>Function <code>GUI_SPY_StartServer()</code> added.</li> <li>Function <code>GUI_SPY_X_StartServer()</code> added.</li> </ul> Chapter <i>2-D Graphic Library</i> updated. <ul style="list-style-type: none"> <li>Function <code>GUI_SetRefreshHook()</code> added.</li> </ul> Chapter <i>Fonts</i> updated. <ul style="list-style-type: none"> <li>Commas added to standard digit fonts.</li> </ul> Chapter <i>Widgets (window objects)</i> updated. <ul style="list-style-type: none"> <li>Some new default values added to <code>FRAMEWIN</code> and <code>WINDOW</code>.</li> <li>Function <code>LISTBOX_EnableWrapMode()</code> added.</li> </ul> Chapter <i>Multi layer / multi display support</i> updated. <ul style="list-style-type: none"> <li>Softlayers added:</li> <li>Function <code>GUI_SOFTLAYER_Enable()</code> added.</li> <li>Function <code>GUI_SOFTLAYER_MULTIBUF_Enable()</code> added.</li> <li>Function <code>GUI_SOFTLAYER_Refresh()</code> added.</li> <li>Function <code>GUI_SOFTLAYER_SetCompositeColor()</code> added.</li> </ul> Chapter <i>Sprites</i> updated. <ul style="list-style-type: none"> <li>Sprites now support true color bitmaps with alpha blending.</li> </ul> Chapter <i>Display drivers</i> updated. <ul style="list-style-type: none"> <li><code>LCD_DEVFUNC_DRAWBMP_8BPP</code> added to <code>LCD_SetDevFunc()</code>.</li> <li>Support for ST7789 added to <code>GUIDRV_FlexColor</code>.</li> <li>Support for UC1638 added to <code>GUIDRV_SPage</code></li> <li>Support for Avant Electronics SBN0064G added to <code>GUIDRV_SPage</code></li> <li>New display driver <code>GUIDRV_7528</code> added</li> </ul> Chapter <i>Configuration</i> updated. <ul style="list-style-type: none"> <li>Function <code>GUI_TASK_GetMaxTask()</code> added.</li> <li>Function <code>GUICC_M1555I_SetCustColorConv()</code> added.</li> <li>Function <code>GUICC_M565_SetCustColorConv()</code> added.</li> <li>Function <code>GUICC_M4444I_SetCustColorConv()</code> added.</li> <li>Function <code>GUICC_M888_SetCustColorConv()</code> added.</li> <li>Function <code>GUICC_M8888I_SetCustColorConv()</code> added.</li> <li>Function <code>GUI_SetFuncAlphaBlending()</code> added.</li> <li>Function <code>GUI_SetFuncGetpPalConvTable()</code> added.</li> <li>Function <code>GUI_SetFuncMixColors()</code> added.</li> <li>Function <code>GUI_SetFuncMixColorsBulk()</code> added.</li> <li>Function <code>GUI_AA_SetpfDrawCharAA4()</code> added.</li> <li>Function <code>GUI_MEMDEV_SetDrawMemdev16bppFunc()</code> added.</li> </ul>
5.26	2	141128	AS	Various corrections.
5.26	1	140821	JE AS	Chapter <i>Widgets (window objects)</i> updated. <ul style="list-style-type: none"> <li>Function <code>MULTIPAGE_SetDefaultBorderSizeX()</code> added.</li> <li>Function <code>MULTIPAGE_SetDefaultBorderSizeY()</code> added.</li> </ul> Various corrections.
5.26	0	140805	JE AS	Chapter <i>2-D Graphic Library</i> updated. <ul style="list-style-type: none"> <li>Function <code>GUI_DIRTYDEVICE_Create()</code> added.</li> <li>Function <code>GUI_DIRTYDEVICE_CreateEx()</code> added.</li> <li>Function <code>GUI_DIRTYDEVICE_Delete()</code> added.</li> <li>Function <code>GUI_DIRTYDEVICE_DeleteEx()</code> added.</li> <li>Function <code>GUI_DIRTYDEVICE_Fetch()</code> added.</li> <li>Function <code>GUI_DIRTYDEVICE_FetchEx()</code> added.</li> </ul> Chapter <i>Bitmap Converter</i> updated. <ul style="list-style-type: none"> <li>Dithering added.</li> </ul>

Software	Revision	Date	By	Description
				<p>Chapter <i>Memory Devices</i> updated.</p> <ul style="list-style-type: none"> <li>• Function GUI_MEMDEV_FadeOutDevices() added.</li> <li>• Function GUI_MEMDEV_RotateHQAlpha() added.</li> <li>• Function GUI_MEMDEV_RotateAlpha() added.</li> <li>• Function GUI_MEMDEV_Dither32() added.</li> </ul> <p>Chapter <i>The Window Manager (WM)</i> updated.</p> <ul style="list-style-type: none"> <li>• Function WM_GetScrollbarH() added.</li> <li>• Function WM_GetScrollbarV() added.</li> <li>• Function WM_SetModalLayer() added.</li> <li>• Function WM_GetModalLayer() added.</li> </ul> <p>Chapter <i>Widgets (window objects)</i> updated.</p> <ul style="list-style-type: none"> <li>• Function LISTVIEW_EnableCellSelect() added.</li> <li>• Function LISTVIEW_GetItemRect() added.</li> <li>• Function LISTVIEW_SetItemTextSorted() added.</li> <li>• Function MULTIPAGE_EnableScrollBar() added.</li> <li>• Function MULTIPAGE_SetBitmap() added.</li> <li>• Function MULTIPAGE_SetBitmapEx() added.</li> <li>• Function MULTIPAGE_SetTabHeight() added.</li> <li>• Function MULTIPAGE_SetTabWidth() added.</li> <li>• Function MULTIPAGE_SetTextAlign() added.</li> </ul> <p>Chapter <i>Anti-aliasing</i> updated.</p> <ul style="list-style-type: none"> <li>• Function GUI_AA_FillEllipse() added.</li> </ul> <p>Chapter <i>Display drivers</i> updated.</p> <ul style="list-style-type: none"> <li>• Support for LGDP4525 added to GUIDRV_FlexColor.</li> <li>• Support for Ilitek ILI9488 added to GUIDRV_FlexColor.</li> <li>• Support for Himax HX8357 added to GUIDRV_FlexColor.</li> <li>• Support for Raio RA8875 added to GUIDRV_FlexColor.</li> <li>• Support for OriseTech SPLC502B added to GUIDRV_SPage.</li> </ul>
5.24	2	140429	SC AS	<p>Table titles were added for all tables except "Permitted values".</p> <p>Chapter <i>Colors</i> updated.</p> <ul style="list-style-type: none"> <li>• Structure 'LCD_PHYSPALETTE' added.</li> <li>• Section 'Look-up table API' added.</li> <li>• Function 'LCD_SetLUT()' added.</li> <li>• Function 'LCD_SetLUTEx()' added.</li> <li>• Function 'LCD_SetLUTEntryEx()' added.</li> </ul>
5.24	1	140225	SC AS	Various corrections.
5.24	0	130801	JE	<p>Chapter <i>2-D Graphic Library</i> updated.</p> <ul style="list-style-type: none"> <li>• New function GUI_CreateBitmapFromStreamA555() added.</li> <li>• New function GUI_CreateBitmapFromStreamAM555() added.</li> <li>• New function GUI_CreateBitmapFromStreamA565() added.</li> <li>• New function GUI_CreateBitmapFromStreamAM565() added.</li> <li>• New function GUI_DrawStreamedBitmapA555Ex() added.</li> <li>• New function GUI_DrawStreamedBitmapAM555Ex() added.</li> <li>• New function GUI_DrawStreamedBitmapA565Ex() added.</li> <li>• New function GUI_DrawStreamedBitmapAM565Ex() added.</li> </ul> <p>Chapter <i>Bitmap Converter</i> updated.</p> <ul style="list-style-type: none"> <li>• New bitmap formats added: 16bpp + 8 bit alpha channel.</li> </ul> <p>Chapter <i>Fonts</i> updated.</p> <ul style="list-style-type: none"> <li>• New function GUI_TTF_CreateFontAA() added.</li> </ul> <p>Chapter <i>Memory Devices</i> updated.</p> <ul style="list-style-type: none"> <li>• New function GUI_MEMDEV_ClearAlpha() added.</li> <li>• New function GUI_MEMDEV_CreateFixed32() added.</li> <li>• New function GUI_MEMDEV_BlendColor32() added.</li> </ul> <p>Chapter <i>The Window Manager (WM)</i> updated.</p> <ul style="list-style-type: none"> <li>• Circular motion support added.</li> </ul> <p>Chapter <i>Widgets (window objects)</i> updated.</p> <ul style="list-style-type: none"> <li>• New widget "KNOB" added.</li> <li>• New function LISTWHEEL_SetDeceleration() added.</li> <li>• New function DROPDOWN_SetListHeight() added.</li> <li>• New function LISTVIEW_OwnerDraw() added.</li> <li>• New function LISTVIEW_SetOwnerDraw() added.</li> <li>• New function LISTVIEW_GetWrapMode() added.</li> <li>• New function MULTIPAGE_GetPageText() added.</li> <li>• New function SPINBOX_SetEditMode() added.</li> <li>• New function SPINBOX_SetStep() added.</li> </ul> <p>New Chapter <i>MultiTouch</i> added.</p> <ul style="list-style-type: none"> <li>• New function GUI_MTOUCH_Enable() added.</li> <li>• New function GUI_MTOUCH_GetEvent() added.</li> <li>• New function GUI_MTOUCH_GetTouchInput() added.</li> <li>• New function GUI_MTOUCH_IsEmpty() added.</li> </ul>

Software	Revision	Date	By	Description
				<ul style="list-style-type: none"> <li>• New function GUI_MTOUCH_SetOrientation() added.</li> <li>• New function GUI_MTOUCH_SetOrientationEx() added.</li> <li>• New function GUI_MTOUCH_StoreEvent() added.</li> <li>• New function WM_EnableGestures() added.</li> </ul> Chapter <i>Anti-aliasing</i> updated. <ul style="list-style-type: none"> <li>• New function GUI_AA_PreserveTrans() added.</li> </ul> Chapter <i>Language Support</i> updated. <ul style="list-style-type: none"> <li>• Remark that Devanagari transitions are not supported.</li> </ul> Chapter <i>Display drivers</i> updated. <ul style="list-style-type: none"> <li>• New function LCD_SetChromaEx() added.</li> <li>• New function LCD_SetChromaModeEx() added.</li> <li>• New function LCD_SetAlpha() added.</li> <li>• New function LCD_SetAlphaModeEx() added.</li> <li>• New function LCD_SetVisEx() added.</li> <li>• Support for Ilitek ILI9163 added to GUIDRV_FlexColor.</li> <li>• Support for RAIO8870 added to GUIDRV_FlexColor.</li> <li>• Support for Solomon SSD1351 added to GUIDRV_FlexColor.</li> <li>• Support for RAIO 8835 added to GUIDRV_SLin.</li> <li>• Support for Samsung S6B0108 added to GUIDRV_SPage.</li> <li>• Support for Hitachi HD61202 added to GUIDRV_SPage.</li> </ul> Chapter <i>Touch drivers</i> updated. <ul style="list-style-type: none"> <li>• New multi touch driver added for PIXCIR TangoC32.</li> </ul> Chapter <i>Performance and Resource Usage</i> updated. <ul style="list-style-type: none"> <li>• New sub chapter 'Optimizing Footprint' added.</li> </ul>
5.22	2	140108	AS	GUIDRV_CompactColor_16: <ul style="list-style-type: none"> <li>• Support for Samsung S6D0128 added to 66772.</li> <li>• Support for Sitronix ST7789 added to 66717.</li> </ul>
5.22	1	130801	AS	Various corrections.
5.22	0	130625	JE AS	New chapter <i>Movies</i> added. Chapter <i>Colors</i> updated. <ul style="list-style-type: none"> <li>• New color conversion GUICC_8 added.</li> </ul> Chapter <i>Memory Devices</i> updated. <ul style="list-style-type: none"> <li>• New function GUI_MEMDEV_BlendWinBk() added.</li> <li>• New function GUI_MEMDEV_BlurAndBlendWinBk() added.</li> <li>• New function GUI_MEMDEV_BlurWinBk() added.</li> <li>• New function GUI_MEMDEV_CreateBlurredDevice32() added.</li> <li>• New function GUI_MEMDEV_CreateBlurredDevice32HQ() added.</li> <li>• New function GUI_MEMDEV_CreateBlurredDevice32LQ() added.</li> <li>• New function GUI_MEMDEV_PunchOutDevice() added.</li> <li>• New function GUI_MEMDEV_RotateHQHR() added.</li> <li>• New function GUI_MEMDEV_RotateHR() added.</li> <li>• New function GUI_MEMDEV_SetBlurHQ() added.</li> <li>• New function GUI_MEMDEV_SetBlurLQ() added.</li> </ul> Chapter <i>Widgets (window objects)</i> updated. <ul style="list-style-type: none"> <li>• Added notification messages sent by the IMAGE widget.</li> <li>• Added notification messages sent by the TEXT widget.</li> <li>• New function GRAPH_SetAutoScrollbar() added.</li> <li>• New function GRAPH_GetScrollValue() added.</li> <li>• New function GRAPH_SetScrollValue() added.</li> <li>• New function ICONVIEW_SetIconAlign() added.</li> <li>• New function LISTWHEEL_GetItemFromPos() added.</li> <li>• New function MULTIEDIT_SetFocussable() added.</li> <li>• New function MULTIPAGE_GetPageText() added.</li> <li>• New function TREEVIEW_ScrollToSel() added.</li> <li>• New section 'Custom widgets' added.</li> </ul> Chapter <i>Sprites</i> updated. <ul style="list-style-type: none"> <li>• New function GUI_SPRITE_SetLoop() added.</li> <li>• New function GUI_SPRITE_StartAnim() added.</li> <li>• New function GUI_SPRITE_StopAnim() added.</li> </ul> Chapter <i>Anti-aliasing</i> updated. <ul style="list-style-type: none"> <li>• New function GUI_AA_FillRoundedRect() added.</li> <li>• New function GUI_AA_FillRoundedRectEx() added.</li> <li>• New function GUI_AA_DrawRoundedRect() added.</li> <li>• New function GUI_AA_DrawRoundedRectEx() added.</li> </ul> Chapter <i>Display drivers</i> updated. <ul style="list-style-type: none"> <li>• New display driver GUIDRV_UC1698G added.</li> <li>• Support for Solomon SSD1306 added to GUIDRV_SPage.</li> </ul> Chapter <i>Timing- and execution-related functions</i> updated. <ul style="list-style-type: none"> <li>• New function GUI_TIMER_Create() added.</li> <li>• New function GUI_TIMER_Delete() added.</li> <li>• New function GUI_TIMER_Restart() added.</li> </ul>

Software	Revision	Date	By	Description
				<ul style="list-style-type: none"> <li>• New function GUI_TIMER_SetPeriod() added.</li> </ul>
5.20	4	130409	AS	GUIDRV_SPage: <ul style="list-style-type: none"> <li>• Support for Solomon SSD1305 added to 1510.</li> </ul>
5.20	3	130409	AS	Various corrections / improvements.
5.20	2	130308	AS	Chapter <i>Language Support</i> updated. <ul style="list-style-type: none"> <li>• New function GUI_LANG_GetTextBuffered() added.</li> <li>• New function GUI_LANG_GetTextBufferedEx() added.</li> </ul>
5.20	1	130305	AS	Chapter <i>Skinning</i> updated. <ul style="list-style-type: none"> <li>• New function CHECKBOX_GetSkinFlexButtonSize() added.</li> <li>• New function CHECKBOX_SetSkinFlexButtonSize() added.</li> </ul>
5.20	0	130218	JE	Chapter <i>Fonts</i> updated. <ul style="list-style-type: none"> <li>• Support for iType® fonts of Monotype Imaging added.</li> </ul> Chapter <i>Colors</i> updated. <ul style="list-style-type: none"> <li>• New color conversions added: GUICC_M8888I, GUICC_M1555I, GUICC_M4444I, GUICC_1616I, GUICC_88666I</li> </ul> Chapter <i>Dialogs</i> updated. <ul style="list-style-type: none"> <li>• CALENDAR dialog and functions added:               <ul style="list-style-type: none"> <li>• CALENDAR_Create()</li> <li>• CALENDAR_GetDate()</li> <li>• CALENDAR_GetSel()</li> <li>• CALENDAR_SetDate()</li> <li>• CALENDAR_SetSel()</li> <li>• CALENDAR_SetDefaultBkColor()</li> <li>• CALENDAR_SetDefaultColor()</li> <li>• CALENDAR_SetDefaultDays()</li> <li>• CALENDAR_SetDefaultFont()</li> <li>• CALENDAR_SetDefaultMonths()</li> <li>• CALENDAR_SetDefaultSize()</li> </ul> </li> </ul> Chapter <i>Sprites</i> updated. <ul style="list-style-type: none"> <li>• New function GUI_SPRITE_CreateHidden() added.</li> <li>• New function GUI_SPRITE_CreateHiddenEx() added.</li> </ul> Chapter <i>Display drivers</i> updated. <ul style="list-style-type: none"> <li>• GUIDRV_FlexColor:               <ul style="list-style-type: none"> <li>• Support for Himax HX8340 added to 66712.</li> <li>• New module 66772 added with support for: Hitachi HD66772, Samsung S6D0117, Sitronix ST7712, Himax HX8301, Ilitek ILI9220 and ILI9221                   <ul style="list-style-type: none"> <li>• GUIDRV_SLin: Support for Epson S1D13305 added.</li> </ul> </li> </ul> </li> </ul> Chapter <i>VNC Server</i> updated. <ul style="list-style-type: none"> <li>• New function GUI_VNC_SetLockFrame() added.</li> </ul> Chapter <i>Timing and execution</i> updated. <ul style="list-style-type: none"> <li>• New function GUI_Error() added.</li> </ul> Chapter <i>Configuration</i> updated. <ul style="list-style-type: none"> <li>• New function GUI_SetOnErrorFunc() added.</li> </ul>
5.18	0	120917	JE AS	Chapter <i>Displaying bitmap files</i> updated. <ul style="list-style-type: none"> <li>• New function GUI_BMP_SerializeExBpp() added.</li> </ul> Chapter <i>Bitmap Converter</i> updated. <ul style="list-style-type: none"> <li>• New functions added to create animated sprites and cursors out of animated GIF files.</li> </ul> Chapter <i>Memory Devices</i> updated. <ul style="list-style-type: none"> <li>• New function GUI_MEMDEV_SerializeBMP() added.</li> </ul> Chapter <i>The Window Manager (WM)</i> updated. <ul style="list-style-type: none"> <li>• New function WM_SetCaptureMove() added.</li> <li>• New function WM_Screen2hWin() added.</li> <li>• New function WM_Screen2hWinEx() added.</li> </ul> Chapter <i>Widgets (window objects)</i> updated. <ul style="list-style-type: none"> <li>• New functions added:               <ul style="list-style-type: none"> <li>• TEXT_GetText()</li> <li>• LISTVIEW_SetWrapMode()</li> </ul> </li> </ul> Chapter <i>Anti-aliasing</i> updated. <ul style="list-style-type: none"> <li>• New function GUI_AA_SetDrawMode() added.</li> </ul> Chapter <i>Language Support</i> updated. <ul style="list-style-type: none"> <li>• New feature "Text" and language resource files" added.</li> </ul> Chapter <i>Display drivers</i> updated. <ul style="list-style-type: none"> <li>• GUIDRV_FlexColor:               <ul style="list-style-type: none"> <li>• Function GUIDRV_FlexColor_SetInterface66709_B16() replaced by the function GUIDRV_FlexColor_SetReadFunc66709_B16().</li> <li>• Function GUIDRV_FlexColor_SetInterface66720_B16() replaced by the function GUIDRV_FlexColor_SetReadFunc66720_B16().</li> <li>• New module 66702 added: Solomon SSD1284, SSD1289, SSD1298</li> </ul> </li> </ul>

Software	Revision	Date	By	Description
				<ul style="list-style-type: none"> <li>• New module 66715 added: Himax HX8352B</li> <li>• Recommended calling sequence for configuration functions added.</li> <li>• GUIDRV_S1D13781:</li> <li>• Additional information about initialized registers added.</li> </ul>
5.16	2	120809	AS	<p>Chapter <i>Widgets (window objects)</i> updated.</p> <ul style="list-style-type: none"> <li>• New function SPINBOX_SetRange() added.</li> </ul> <p>Various corrections.</p>
5.16	1	120628	AS	<p>Chapter <i>The Window Manager (WM)</i> updated.</p> <ul style="list-style-type: none"> <li>• Descriptions of the following functions reworked: <ul style="list-style-type: none"> <li>• WM_GetScrollPosH()</li> <li>• WM_GetScrollPosV()</li> <li>• WM_SetScrollPosH()</li> <li>• WM_SetScrollPosV()</li> </ul> </li> <li>• Preface, About and Chapter <i>Introduction</i> reworked.</li> </ul>
5.16	0	120605	JE AS	<p>Chapter <i>Colors</i> updated.</p> <ul style="list-style-type: none"> <li>• New color conversion routine added to support 1bpp at different color depths.</li> </ul> <p>Chapter <i>Memory Devices</i> updated.</p> <ul style="list-style-type: none"> <li>• New function GUI_MEMDEV_RotateHQT() added.</li> </ul> <p>Chapter <i>The Window Manager (WM)</i> updated.</p> <ul style="list-style-type: none"> <li>• Support for ToolTips added.</li> <li>• New functions added: <ul style="list-style-type: none"> <li>• WM_TOOLTIP_AddTool()</li> <li>• WM_TOOLTIP_Create()</li> <li>• WM_TOOLTIP_Delete()</li> <li>• WM_TOOLTIP_SetDefaultFont()</li> <li>• WM_TOOLTIP_SetDefaultColor()</li> <li>• WM_TOOLTIP_SetDefaultPeriod()</li> </ul> </li> </ul> <p>Chapter <i>Widgets (window objects)</i> updated.</p> <ul style="list-style-type: none"> <li>• New functions added: <ul style="list-style-type: none"> <li>• BUTTON_SetReactOnTouch()</li> <li>• DROPDOWN_SetUpMode()</li> <li>• ICONVIEW_EnableStreamAuto()</li> </ul> </li> </ul> <p>Changed function SPINBOX_SetButtonSize():</p> <ul style="list-style-type: none"> <li>• New option SPINBOX_EDGE_CENTER.</li> </ul> <p>Chapter <i>Dialogs</i> updated.</p> <ul style="list-style-type: none"> <li>• CHOOSECOLOR dialog and functions added: <ul style="list-style-type: none"> <li>• CHOOSECOLOR_Create()</li> <li>• CHOOSECOLOR_GetSel()</li> <li>• CHOOSECOLOR_SetSel()</li> <li>• CHOOSECOLOR_SetDefaultColor()</li> <li>• CHOOSECOLOR_SetDefaultSpace()</li> <li>• CHOOSECOLOR_SetDefaultBorder()</li> <li>• CHOOSECOLOR_SetDefaultButtonSize()</li> </ul> </li> <li>• CHOOSEFILE_EnableToolTips()</li> <li>• CHOOSEFILE_SetButtonText()</li> <li>• CHOOSEFILE_SetDefaultButtonText()</li> <li>• CHOOSEFILE_SetToolTips()</li> <li>• CHOOSEFILE_SetTopMode()</li> </ul> <p>Chapter <i>Pointer Input Devices</i> updated.</p> <ul style="list-style-type: none"> <li>• New function GUI_PID_IsPressed() added.</li> </ul> <p>Chapter <i>Keyboard Input</i> updated.</p> <ul style="list-style-type: none"> <li>• New function GUI_GetKeyState() added.</li> </ul> <p>Chapter <i>Language Support</i> updated.</p> <ul style="list-style-type: none"> <li>• New function GUI_LANG_GetNumItems() added.</li> </ul> <p>Chapter <i>Language Support</i> updated.</p> <ul style="list-style-type: none"> <li>• New function GUI_LANG_GetText() added.</li> <li>• New function GUI_LANG_GetTextEx() added.</li> <li>• New function GUI_LANG_LoadCSV() added.</li> <li>• New function GUI_LANG_LoadCSVEx() added.</li> <li>• New function GUI_LANG_LoadText() added.</li> <li>• New function GUI_LANG_LoadTextEx() added.</li> <li>• New function GUI_LANG_SetLang() added.</li> <li>• New function GUI_LANG_SetMaxNumLang() added.</li> <li>• New function GUI_LANG_SetSep() added.</li> </ul> <p>Chapter <i>Display drivers</i> updated.</p> <ul style="list-style-type: none"> <li>• New display controller supported by <ul style="list-style-type: none"> <li>• GUIDRV_SPage, GUIDRV_SPage_Set1510:</li> <li>• Epson S1D15605, S1D15606, S1D15607, S1D15608, S1D15705, S1D15710, S1D15714</li> <li>• Integrated Solutions Technology IST3020</li> <li>• New Japan Radio Company NJU6676</li> </ul> </li> </ul>

Software	Revision	Date	By	Description
				<ul style="list-style-type: none"> <li>• Novatek NT7502, NT7534, NT7538, NT75451</li> <li>• Samsung S6B0719, S6B0713, S6B0724, S6B1713</li> <li>• Sino Wealth SH1101A</li> <li>• Sitronix ST7522, ST7565, ST7567</li> <li>• Solomon SSD1303, SSD1805, SSD1815, SSD1821</li> <li>• Sunplus SPLC501C</li> <li>• UltraChip UC1608, UC1701, UC1601, UC1606</li> <li>• GUIDRV_SPage_Set1512:</li> <li>• Epson S1D15E05, S1D15E06, S1D15719, S1D15721</li> <li>• GUIDRV_SPage_SetST7591: Sitronix ST7591</li> <li>• New display controllers supported by GUIDRV_FlexColor:</li> <li>• 66708: Ilitek ILI9335</li> <li>• 66709: Ilitek ILI9338, ILI9340, ILI9341, ILI9342</li> <li>• 66719: Samsung S6E63D6</li> <li>• New function LCD_SetMaxNumColors() added.</li> <li>• Support for 1bpp added to GUIDRV_SPage.</li> <li>• Function GUIDRV_SPage_SetS1D15() obsolete, replaced by GUIDRV_SPage_Set1512</li> <li>• New variants GUIDRV_Lin added:</li> <li>• GUIDRV_LIN_OX_8</li> <li>• GUIDRV_LIN_OXY_8</li> <li>• New driver GUIDRV_S1D13781 added.</li> </ul> <p>New chapter <i>Touch drivers</i> added.</p> <ul style="list-style-type: none"> <li>• New driver GUITDRV_ADS7846 added.</li> </ul>
5.14	3	120202	AS	<p>Chapter <i>Display drivers</i> updated.</p> <ul style="list-style-type: none"> <li>• New display controller supported by GUIDRV_FlexColor:</li> <li>• 66709: Ilitek ILI9340</li> <li>• New display controllers supported by GUIDRV_SPage:</li> <li>• Epson S1D15605, S1D15606, S1D15607, S1D15608, S1D15705, S1D15710, S1D15714</li> <li>• Integrated Solutions Technology IST3020</li> <li>• New Japan Radio Company NJU6676</li> <li>• Novatek NT7502, NT7534, NT7538, NT75451</li> <li>• Samsung S6B0719, S6B0713, S6B0724, S6B1713</li> <li>• Sino Wealth SH1101A</li> <li>• Sitronix ST7522, ST7565, ST7567</li> <li>• Solomon SSD1805, SSD1303, SSD1815</li> <li>• UltraChip UC1608, UC1701, UC1601, UC1606</li> <li>• Sunplus SPLC501C</li> <li>• New function GUIDRV_SPage_Set1510 added.</li> <li>• New function GUIDRV_SPage_Set1512 added.</li> </ul>
5.14	2	120201	AS	<p>Chapter <i>Displaying bitmaps files</i> updated.</p> <ul style="list-style-type: none"> <li>• Improved description of the 'GetData'-function.</li> </ul> <p>Chapter <i>Display drivers</i> updated.</p> <ul style="list-style-type: none"> <li>• GUIDRV_SPage now supports 1bpp.</li> <li>• New display controllers supported by GUIDRV_SPage:</li> <li>• Epson S1D15E05, S1D15E06, S1D15719, S1D15721</li> <li>• Sitronix ST7591</li> <li>• New function GUIDRV_SPage_SetST7591 added.</li> </ul>
5.14	1	120124	AS	<p>Chapter <i>Widgets (window objects)</i> updated.</p> <ul style="list-style-type: none"> <li>• New function EDIT_GetTextColor().</li> <li>• New function SPINBOX_GetEditHandle().</li> </ul>
5.14	0	120111	JE AS	<p>Chapter <i>Simulation</i> updated.</p> <ul style="list-style-type: none"> <li>• New function SIM_GUI_Enable() added.</li> </ul> <p>Chapter <i>2-D Graphic Library</i> updated.</p> <ul style="list-style-type: none"> <li>• New functions added:</li> <li>• GUI_DrawStreamedBitmapAuto()</li> <li>• GUI_DrawStreamedBitmapExAuto()</li> <li>• GUI_DrawStreamedBitmap24Ex()</li> <li>• GUI_DrawStreamedBitmap555Ex()</li> <li>• GUI_DrawStreamedBitmap565Ex()</li> <li>• GUI_DrawStreamedBitmapM555Ex()</li> <li>• GUI_DrawStreamedBitmapM565Ex()</li> </ul> <p>Chapter <i>Font Converter</i> updated.</p> <ul style="list-style-type: none"> <li>• Functions to size, shift and move characters added.</li> </ul> <p>Chapter <i>Colors</i> updated.</p> <ul style="list-style-type: none"> <li>• Sub chapter 'Gamma correction' added.</li> </ul> <p>Chapter <i>The Window Manager (WM)</i> updated.</p> <ul style="list-style-type: none"> <li>• Change of the WM_MOVE message to transmit position changes.</li> <li>• New functions added:</li> <li>• WM_MOTION_Enable()</li> </ul>

Software	Revision	Date	By	Description
				<ul style="list-style-type: none"> <li>• WM_MOTION_SetMovement()</li> <li>• WM_MOTION_SetDeceleration()</li> <li>• WM_MOTION_SetDefaultPeriod()</li> <li>• WM_MOTION_SetMotion()</li> <li>• WM_MOTION_SetMoveable()</li> <li>• WM_MOTION_SetSpeed()</li> </ul> <p>Chapter <i>Widgets (window objects)</i> updated.</p> <ul style="list-style-type: none"> <li>• New widget "SPINBOX" added.</li> <li>• New widget "IMAGE" added.</li> <li>• Return values added to the following functions: <ul style="list-style-type: none"> <li>• BUTTON_SetText()</li> <li>• TEXT_SetText()</li> </ul> </li> <li>• New function DROPDOWN_GetItemText() added.</li> <li>• New function EDIT_GetBkColor() added.</li> <li>• New function EDIT_SetBkColor() added.</li> <li>• New function EDIT_SetFocussable() added.</li> <li>• New function EDIT_GetFont() added.</li> <li>• New function GUI_EditFloat() added.</li> <li>• Listing of widget IDs added.</li> </ul> <p>Chapter <i>Sprites</i> updated.</p> <ul style="list-style-type: none"> <li>• New function GUI_SPRITE_CreateAnim() added.</li> <li>• New function GUI_SPRITE_CreateExAnim() added.</li> </ul> <p>Chapter <i>Cursors</i> updated.</p> <ul style="list-style-type: none"> <li>• New function GUI_CURSOR_SelectAnim() added.</li> </ul> <p>Chapter <i>Display drivers</i> updated.</p> <ul style="list-style-type: none"> <li>• New display controllers supported by GUIDRV_FlexColor: <ul style="list-style-type: none"> <li>• 66708: FocalTech FT1509</li> <li>• 66709: Renesas R61526</li> <li>• 66709: Ilitek ILI9342</li> <li>• 66712: Himax HX8347</li> <li>• 66712: Himax HX8352</li> </ul> </li> <li>• New display controllers supported by GUIDRV_CompactColor_16: <ul style="list-style-type: none"> <li>• 66708: FocalTech FT1509</li> <li>• 66709: Renesas R61526</li> <li>• 66709: Ilitek ILI9342</li> </ul> </li> </ul>
5.12	1	111021	AS	<p>Font Converter documentation added as chapter 11.</p> <ul style="list-style-type: none"> <li>• New function GUIDRV_FlexColor_SetFunc66712() added.</li> <li>• New function GUIDRV_FlexColor_SetInterface66712B16() added.</li> <li>• New display controller supported by GUIDRV_07X1: <ul style="list-style-type: none"> <li>• 741: Novatek NT7508</li> </ul> </li> <li>• New display controller supported by GUIDRV_Page1bpp: <ul style="list-style-type: none"> <li>• 1510: Solomon SSD1821</li> </ul> </li> <li>• GUIDRV_Lin 'Using the Lin driver in systems with cache memory' changed.</li> </ul>
5.12	0	110621	AS JE	<p>Chapter <i>Widgets (window objects)</i> updated.</p> <ul style="list-style-type: none"> <li>• New function LISTVIEW_SetHeaderHeight() added.</li> <li>• New function ICONVIEW_AddStreamedBitmapItem() added.</li> <li>• New function ICONVIEW_GetItemText() added.</li> <li>• New function ICONVIEW_GetItemUserData() added.</li> <li>• New function ICONVIEW_GetNumItems() added.</li> <li>• New function ICONVIEW_InsertBitmapItem() added.</li> <li>• New function ICONVIEW_InsertStreamedBitmapItem() added.</li> <li>• New function ICONVIEW_SetBitmapItem() added.</li> <li>• New function ICONVIEW_SetFrame() added.</li> <li>• New function ICONVIEW_SetItemText() added.</li> <li>• New function ICONVIEW_SetItemUserData() added.</li> <li>• New function ICONVIEW_SetSpace() added.</li> <li>• New function ICONVIEW_SetStreamedBitmapItem() added.</li> <li>• New function ICONVIEW_SetTextAlign() added.</li> <li>• New function TEXT_GetNumLines() added.</li> </ul> <p>Chapter <i>Display drivers</i> updated.</p> <ul style="list-style-type: none"> <li>• New display drivers added: <ul style="list-style-type: none"> <li>• GUIDRV_Dist</li> <li>• GUIDRV_SPage</li> </ul> </li> <li>• New display controller supported by GUIDRV_CompactColor_16: <ul style="list-style-type: none"> <li>• 66709: Solomon SSD1961</li> </ul> </li> <li>• LCD_SetDevFunc(): LCD_DEVFUNC_COPYRECT added.</li> <li>• GUIDRV_Lin: Support for LCD_DEVFUNC_COPYRECT added.</li> </ul>
5.10	1	110531	AS JE	<p>Chapter <i>Display drivers</i> updated.</p> <ul style="list-style-type: none"> <li>• New display driver: GUIDRV_FlexColor</li> </ul>

Software	Revision	Date	By	Description
5.10	0	110329	AS JE	<p>Chapter <i>Memory Devices</i> updated.</p> <ul style="list-style-type: none"> <li>• Default for <code>GUI_USE_MEMDEV_1BPP_FOR_SCREEN</code> set to 1.</li> <li>• New function <code>GUI_MEMDEV_MarkDirty()</code> added.</li> </ul> <p>New chapter <i>GUI Builder</i> added.</p> <p>Chapter <i>Display drivers</i> updated.</p> <ul style="list-style-type: none"> <li>• New display controllers supported by <code>GUIDRV_CompactColor_16</code>:</li> <li>• 66708: Ilitek ILI9328</li> <li>• 66709: Sitronix ST7715</li> <li>• 66772: Ilitek ILI9221</li> <li>• New function <code>GUIDRV_BitPlains_Config()</code> added.</li> </ul>
5.08	0	110112	AS JE	<p>Chapter <i>2-D Graphic Library</i> updated.</p> <ul style="list-style-type: none"> <li>• New function <code>GUI_CreateBitmapFromStreamRLEAlpha()</code> added.</li> <li>• New function <code>GUI_CreateBitmapFromStreamRLE32()</code> added.</li> <li>• Function <code>GUI_CreateBitmapFromStream()</code> supports additional formats.</li> </ul> <p>Chapter <i>Bitmap Converter</i> updated.</p> <ul style="list-style-type: none"> <li>• New format 'Alpha channel, compressed' added.</li> <li>• New format 'True color with alpha channel, compressed' added.</li> <li>• New function 'Image/Convert Into/Best Palette + transparency' added.</li> </ul> <p>Chapter <i>Memory Devices</i> updated.</p> <ul style="list-style-type: none"> <li>• New functions <code>GUI_MEMDEV_SetAnimationCallback()</code> added.</li> <li>• New functions <code>GUI_MEMDEV_ShiftInWindow()</code> added.</li> <li>• New functions <code>GUI_MEMDEV_ShiftOutWindow()</code> added.</li> </ul> <p>Chapter <i>Execution Model: Single Task / Multitask</i> updated.</p> <ul style="list-style-type: none"> <li>• New function <code>GUI_SetSignalEventFunc()</code> added.</li> <li>• New function <code>GUI_SetWaitEventFunc()</code> added.</li> <li>• New function <code>GUI_SetWaitEventTimedFunc()</code> added.</li> <li>• Definitions of configuration macros changed.</li> </ul> <p>Chapter <i>The Window Manager (WM)</i> updated.</p> <ul style="list-style-type: none"> <li>• New function <code>WM_MULTIBUF_Enable()</code> added.</li> <li>• New messages <code>WM_PRE_PAINT</code> and <code>WM_POST_PAINT</code> added.</li> </ul> <p>Chapter <i>Widgets (window objects)</i> updated.</p> <ul style="list-style-type: none"> <li>• <code>LISTVIEW_SetUserData()</code> renamed in <code>LISTVIEW_SetUserDataRow()</code>.</li> <li>• <code>LISTVIEW_GetUserData()</code> renamed in <code>LISTVIEW_GetUserDataRow()</code>.</li> <li>• New function <code>&lt;WIDGET&gt;_SetUserData()</code> added for all widgets.</li> <li>• New function <code>&lt;WIDGET&gt;_GetUserData()</code> added for all widgets.</li> <li>• New function <code>&lt;WIDGET&gt;_CreateUser()</code> added for all widgets.</li> <li>• New function <code>BUTTON_GetTextAlign()</code> added.</li> <li>• New function <code>BUTTON_SetReactOnLevel()</code> added.</li> <li>• New function <code>ICONVIEW_CreateIndirect()</code> added.</li> <li>• New function <code>ICONVIEW_DeleteItem()</code> added.</li> <li>• New function <code>LISTWHEEL_CreateIndirect()</code> added.</li> <li>• New function <code>SCROLLBAR_SetThumbSizeMin()</code> added.</li> <li>• New function <code>SCROLLBAR_GetThumbSizeMin()</code> added.</li> <li>• New function <code>TREEVIEW_ITEM_CollapseAll()</code> added.</li> <li>• New function <code>TREEVIEW_ITEM_ExpandAll()</code> added.</li> </ul> <p>Chapter <i>Skining</i> updated.</p> <ul style="list-style-type: none"> <li>• New configuration macro <code>WIDGET_USE_FLEX_SKIN</code> added.</li> <li>• New message <code>WIDGET_ITEM_GET_RADIUS</code> added to frame window skin.</li> </ul> <p>Chapter <i>Multiple Buffering</i> updated.</p> <ul style="list-style-type: none"> <li>• New function <code>GUI_MULTIBUF_Begin()</code> added.</li> <li>• New function <code>GUI_MULTIBUF_End()</code> added.</li> <li>• New function <code>GUI_MULTIBUF_Config()</code> added.</li> </ul> <p>Chapter <i>Language Support</i></p> <ul style="list-style-type: none"> <li>• New function <code>GUI_UC_EnableBIDI()</code> added.</li> </ul>
5.06	0	100907	JE	<p>Chapter <i>Fonts</i> updated.</p> <ul style="list-style-type: none"> <li>• New function <code>GUI_SetDefaultFont()</code> added.</li> </ul> <p>Chapter <i>Memory Devices</i> updated.</p> <ul style="list-style-type: none"> <li>• New function <code>GUI_MEMDEV_FadeDevices()</code> added.</li> </ul> <p>Chapter <i>Widgets (window objects)</i> updated.</p> <ul style="list-style-type: none"> <li>• New function <code>BUTTON_SetReactOnLevel()</code> added.</li> <li>• New function <code>GRAPH_DATA_XY_SetOwnerDraw()</code> added.</li> <li>• New function <code>LISTVIEW_SetItemBitmap()</code> added.</li> <li>• New function <code>LISTWHEEL_SetPos()</code> added.</li> <li>• New function <code>SCROLLBAR_GetNumItems()</code> added.</li> <li>• New function <code>SCROLLBAR_GetPageSize()</code> added.</li> </ul> <p>New Chapter <i>Skining</i> added.</p> <ul style="list-style-type: none"> <li>• Skining for the most common widgets added.</li> </ul> <p>Chapter <i>Display drivers</i> updated.</p> <ul style="list-style-type: none"> <li>• New function <code>GUI_SetOrientation()</code> added.</li> <li>• New OXY-orientations for 16, 24 and 32 bpp added to <code>GUIDRV_Lin</code>.</li> </ul>



Software	Revision	Date	By	Description
5.04	2	100526	AS	<p>Chapter <i>Widgets (window objects)</i> updated.</p> <ul style="list-style-type: none"> <li>• New function <code>GRAPH_DATA_XY_SetOwnerDraw()</code> added.</li> <li>• New function <code>LISTVIEW_SetItemBitmap()</code> added.</li> </ul> <p>Chapter <i>Fonts</i> updated.</p> <ul style="list-style-type: none"> <li>• New function <code>GUI_SetDefaultFont()</code> added.</li> </ul> <p>Chapter <i>2-D Graphic Library</i> updated.</p> <ul style="list-style-type: none"> <li>• New function <code>GUI_GetPixelIndex()</code> added.</li> </ul> <p>Chapter <i>Execution Model: Single Task / Multitask</i> updated.</p> <ul style="list-style-type: none"> <li>• <code>GUI_TASK_SetMaxTask()</code></li> <li>• <code>GUIDRV_CompactColor_16:</code></li> <li>• Support for the following display controllers added: <ul style="list-style-type: none"> <li>• Himax HX8353</li> <li>• LGDP4551</li> <li>• Orisetech SPFD54124C</li> <li>• Renesas R61505</li> <li>• Sitronix ST7735, ST7787</li> <li>• Solomon SSD1284, SSD2119</li> </ul> </li> <li>• Added driver macros to each driver which uses them.</li> </ul>
5.04	1	100505	AS	<p>New Drivers 'GUIDRV_S1D15G00' and 'GUIDRV_SLin' added.</p> <p>Various corrections</p> <p>Chapter <i>2-D Graphic Library</i> updated.</p> <ul style="list-style-type: none"> <li>• New function <code>GUI_DrawGradientRoundedV()</code></li> <li>• New function <code>GUI_DrawGradientRoundedH()</code></li> <li>• New function <code>GUI_DrawRoundedFrame()</code></li> </ul> <p>Chapter <i>Memory Devices</i> updated.</p> <ul style="list-style-type: none"> <li>• New function <code>GUI_MEMDEV_MoveInWindow()</code></li> <li>• New function <code>GUI_MEMDEV_MoveOutWindow()</code></li> <li>• New function <code>GUI_MEMDEV_FadeInWindow()</code></li> <li>• New function <code>GUI_MEMDEV_FadeOutWindow()</code></li> </ul> <p>Chapter <i>Simulation</i> updated.</p> <ul style="list-style-type: none"> <li>• New function <code>SIM_GUI_SetCallback()</code></li> <li>• New function <code>SIM_GUI_ShowDevice()</code></li> </ul>
5.04	0	100104	JE	<p>Chapter <i>Displaying Text</i> updated.</p> <ul style="list-style-type: none"> <li>• New function <code>GUI_DispStringInRectWrap()</code> added.</li> <li>• New function <code>GUI_WrapGetNumLines()</code> added.</li> </ul> <p>Chapter <i>2-D Graphic Library</i> updated.</p> <ul style="list-style-type: none"> <li>• New function <code>GUI_EnableAlpha()</code> added.</li> <li>• New function <code>GUI_RestoreUserAlpha()</code> added.</li> <li>• New function <code>GUI_SetUserAlpha()</code> added.</li> <li>• New function <code>GUI_CreateBitmapFromStream()</code> added.</li> <li>• New function <code>GUI_DrawStreamedBitmapEx()</code> added.</li> <li>• New function <code>GUI_GetStreamedBitmapInfo()</code> added.</li> <li>• New function <code>GUI_GetStreamedBitmapInfoEx()</code> added.</li> <li>• New function <code>GUI_SetStreamedBitmapHook()</code> added.</li> <li>• New function <code>GUI_CreateBitmapFromStreamIDX()</code> added.</li> <li>• New function <code>GUI_CreateBitmapFromStreamRLE4()</code> added.</li> <li>• New function <code>GUI_CreateBitmapFromStreamRLE8()</code> added.</li> <li>• New function <code>GUI_CreateBitmapFromStream565()</code> added.</li> <li>• New function <code>GUI_CreateBitmapFromStream565()</code> added.</li> <li>• New function <code>GUI_CreateBitmapFromStream555()</code> added.</li> <li>• New function <code>GUI_CreateBitmapFromStream555()</code> added.</li> <li>• New function <code>GUI_CreateBitmapFromStreamRLE16()</code> added.</li> <li>• New function <code>GUI_CreateBitmapFromStreamRLEM16()</code> added.</li> <li>• New function <code>GUI_CreateBitmapFromStream24()</code> added.</li> <li>• New function <code>GUI_CreateBitmapFromStreamAlpha()</code> added.</li> </ul> <p>Chapter <i>Fonts</i> updated.</p> <ul style="list-style-type: none"> <li>• New font <code>F20F_ASCII (framed)</code> added.</li> <li>• New fonts <code>F6x8_ASCII</code> and <code>F6x8_1</code> added.</li> <li>• New fonts <code>F8x8_ASCII</code> and <code>F8x8_1</code> added.</li> <li>• New fonts <code>F8x16_ASCII</code> and <code>F8x16_1</code> added.</li> <li>• Support for new font formats extended AA2 and extended AA4 added.</li> </ul> <p>Chapter <i>Memory Devices</i> updated.</p> <ul style="list-style-type: none"> <li>• Considerations for multiple layers/displays added.</li> </ul> <p>Chapter <i>The Window Manager (WM)</i> updated.</p> <ul style="list-style-type: none"> <li>• <code>WM_DeleteWindow()</code> now also deletes any associated timer.</li> </ul> <p>Chapter <i>Widgets (window objects)</i> updated.</p> <ul style="list-style-type: none"> <li>• New function <code>WINDOW_SetBkColor()</code> added.</li> </ul> <p>Chapter <i>Pointer Input Devices</i> updated.</p> <ul style="list-style-type: none"> <li>• PID buffer added.</li> <li>• Explanation of touch calibration revised.</li> </ul> <p>Chapter <i>Keyboard Input</i> updated.</p> <ul style="list-style-type: none"> <li>• Keyboard buffer added.</li> </ul>

Software	Revision	Date	By	Description
				Chapter <i>Display drivers</i> updated. <ul style="list-style-type: none"> <li>• New driver GUIDRV_BitPlains added.</li> <li>• New driver GUIDRV_SLin added.</li> <li>• New driver GUIDRV_SSD1926 added.</li> <li>• Driver GUIDRV_1611 added.</li> <li>• Driver GUIDRV_6331 added.</li> <li>• Driver GUIDRV_7529 added.</li> <li>• Driver GUIDRV_Page1bpp added.</li> <li>• GUIDRV_CompactColor_16:</li> <li>• Support for the following display controllers added:               <ul style="list-style-type: none"> <li>• Himax HX8340, HX8352</li> <li>• Solomon SSD1298, SSD1355, SSD1963</li> <li>• Epson S1D19122</li> <li>• Orisetech SPFD5414D</li> <li>• Ilitek ILI9320, ILI9326</li> </ul> </li> </ul> Chapter <i>VNC Server</i> updated. <ul style="list-style-type: none"> <li>• New function GUI_VNC_EnableKeyboardInput()</li> <li>• New function GUI_VNC_GetNumConnections()</li> <li>• New function GUI_VNC_SetPassword()</li> <li>• New function GUI_VNC_SetProgName()</li> <li>• New function GUI_VNC_SetSize()</li> <li>• New function GUI_VNC_RingBell()</li> </ul>
5.00	1	090409	JE	Chapter <i>Simulation</i> updated. <ul style="list-style-type: none"> <li>• Completely revised.</li> </ul> Chapter <i>Displaying bitmap files</i> updated. <ul style="list-style-type: none"> <li>• PNG support added.</li> </ul>
5.00	0	090409	JE	Software has been completely revised. For the version history of earlier versions, refer to older documents.

# About this document

---

## Assumptions

This document assumes that you already have a solid knowledge of the following:

- The software tools used for building your application (assembler, linker, C compiler).
- The C programming language.
- The target processor.
- DOS command line.

If you feel that your knowledge of C is not sufficient, we recommend C: A Reference Manual by Harbison and Steele (ISBN 0--13--089592X). This book provides a complete description of the C language, the run-time libraries, and a style of C programming that emphasizes correctness, portability, and maintainability.

## How to use this manual

This manual explains all the functions and macros that the product offers. It assumes you have a working knowledge of the C language. Knowledge of assembly programming is not required.

## Typographic conventions for syntax

This manual uses the following typographic conventions:

Style	Used for
Body	Body text.
Parameter	Parameters in API functions.
Sample	Sample code in program examples.
Sample comment	Comments in program examples.
User Input	Text entered at the keyboard by a user in a session transcript.
Secret Input	Text entered at the keyboard by a user, but not echoed (e.g. password entry), in a session transcript.
Reference	Reference to chapters, sections, tables and figures.
<b>Emphasis</b>	Very important sections.
<i>SEgger home page</i>	A hyperlink to an external document or web site.



# Table of contents

---

1	Introduction to emWin .....	77
1.1	Purpose of this document .....	78
1.2	Requirements .....	79
1.2.1	Target system (hardware) .....	79
1.2.2	Development environment (compiler) .....	79
1.3	Features .....	81
1.4	Complete emWin system .....	83
1.5	Examples and demos .....	84
1.6	AppWizard .....	86
1.7	Screen and coordinates .....	87
1.8	How to connect the display to the microcontroller .....	88
1.9	Data types .....	89
2	Getting Started .....	90
2.1	Recommended project structure .....	91
2.2	Subdirectories .....	92
2.2.1	Include directories .....	92
2.3	Adding emWin to the target program .....	94
2.4	Creating a library .....	95
2.4.1	Adapting the library batch files to a different system .....	96
2.5	C files to include in the project .....	99
2.6	CMake support .....	100
2.7	Configuring emWin .....	102
2.7.1	Configuration macros .....	102
2.8	Initializing emWin .....	103
2.8.1	GUI_Init() .....	104
2.8.2	GUI_IsInitialized() .....	105
2.8.3	GUI_Exit() .....	106
2.9	Using emWin with target hardware .....	107
2.10	The "Hello world" example program .....	108
3	Configuration .....	109
3.1	What needs to be configured? .....	110
3.2	Run-time- and compile-time configuration .....	111
3.3	Initialization process of emWin .....	112
3.4	Run-time configuration .....	113
3.4.1	Customizing GUIConf.c .....	113
3.4.1.1	API functions to be used in GUI_X_Config() .....	113
3.4.1.1.1	GUI_ALLOC_AssignMemory() .....	114

3.4.1.1.2	GUI_RegisterAfterInitHook()	115
3.4.1.1.3	GUI_SetOnErrorFunc()	116
3.4.1.1.4	GUI_SetOnLogFunc()	117
3.4.1.1.5	GUI_SetOnWarnFunc()	118
3.4.1.1.6	GUITASK_GetMaxTask()	119
3.4.1.1.7	GUITASK_SetMaxTask()	120
3.4.2	Customizing LCDConf.c	121
3.4.2.1	LCD_X_Config()	122
3.4.2.2	LCD_X_DisplayDriver()	123
3.4.2.3	API functions to be used in LCD_X_Config()	124
3.4.2.3.1	GUI_DEVICE_CreateAndLink()	125
3.4.3	Customizing GUI_X.c	126
3.4.3.1	Init routines	126
3.4.3.1.1	GUI_X_Init()	126
3.4.3.2	Timing routines	127
3.4.3.2.1	GUI_X_Delay()	127
3.4.3.2.2	GUI_X_ExecIdle()	128
3.4.3.2.3	GUI_X_GetTime()	129
3.4.3.3	Debug routines	130
3.4.3.3.1	GUI_X_ErrorOut()	130
3.4.3.3.2	GUI_X_Warn()	130
3.4.3.3.3	GUI_X_Log()	130
3.4.3.4	Kernel interface routines	131
3.4.4	Function replacement	131
3.4.4.1	GUI_SetpfMemcpy()	132
3.4.4.2	GUI_SetpfMemset()	133
3.4.4.3	GUI_SetpfStrcmp()	134
3.4.4.4	GUI_SetpfStrcpy()	135
3.4.4.5	GUI_SetpfStrlen()	136
3.5	Compile-time configuration	137
3.5.1	Customizing GUIConf.h	137
3.5.1.1	Configuring the available features of emWin	137
3.5.1.2	Default font and default color configuration	137
3.5.1.3	Advanced GUI configuration options	138
3.5.1.3.1	GUI_MEMCPY (obsolete)	138
3.5.1.3.2	GUI_MEMSET (obsolete)	139
3.5.1.3.3	GUI_POST_INIT	139
3.5.1.3.4	GUI_TRIAL_VERSION	139
3.5.2	Customizing LCDConf.h	139
3.6	Framebuffer cache	140
3.6.1	Embedded caching: Cache integrated into a display driver	140
3.6.2	GUI_GCACHE: Global cache with optional color reducer	140
3.6.2.1	GUI_GCACHE API	141
3.6.2.1.1	GUI_GCACHE_Create()	142
3.6.2.1.2	GUI_GCACHE_CreateEx()	143
3.6.2.1.3	GUI_GCACHE_CreateUserEx()	144
3.6.2.1.4	GUI_GCACHE modes	145
3.7	Framebuffer located in data cache area of CPU	146
3.7.1	Requirements	146
3.7.2	Using multiple buffers and a data cache	146
3.7.2.1	How it works	146
3.7.2.2	Animations and multiple buffering	146
3.7.2.3	Memory device animation functions	147
3.7.3	Available API functions	147
3.7.3.1	GUI_DCACHE_Clear()	148
3.7.3.2	GUI_DCACHE_SetClearCacheHook()	149
3.8	Hardware acceleration	150
3.8.1	Ready to use configurations	150
3.8.2	Using D/AVE 2D hardware IP core	151
3.8.3	Using ChromART accelerator	151

3.8.4	Using NXP Pixel Pipeline .....	151
3.8.5	Using Vivante VGLite .....	152
3.8.6	Available API functions .....	152
3.8.6.1	Color conversion .....	155
3.8.6.1.1	GUICC_M1555I_SetCustColorConv() .....	155
3.8.6.1.2	GUICC_M565_SetCustColorConv() .....	155
3.8.6.1.3	GUICC_M4444I_SetCustColorConv() .....	155
3.8.6.1.4	GUICC_M888_SetCustColorConv() .....	155
3.8.6.1.5	GUICC_M8888I_SetCustColorConv() .....	155
3.8.6.2	Filling, copy operations and bitmap drawing .....	156
3.8.6.2.1	GUI_SetFuncDrawM565() .....	156
3.8.6.3	Alpha blending .....	157
3.8.6.3.1	GUI_AlphaEnableFillRectHW() .....	157
3.8.6.3.2	GUI_SetFuncAlphaBlending() .....	158
3.8.6.3.3	GUI_SetFuncDrawAlpha() .....	159
3.8.6.3.4	GUI_SetFuncDrawA8() .....	160
3.8.6.4	Mixing colors .....	161
3.8.6.4.1	GUI_SetFuncMixColors() .....	161
3.8.6.4.2	GUI_SetFuncMixColorsBulk() .....	162
3.8.6.5	Alpha text drawing .....	163
3.8.6.5.1	GUI_AA_SetpfDrawCharAA4() .....	163
3.8.6.6	Palette conversion .....	164
3.8.6.6.1	GUI_SetFuncGetpPalConvTable() .....	164
3.8.6.7	Drawing bitmaps within memory devices .....	165
3.8.6.7.1	GUI_MEMDEV_SetDrawMemdev16bppFunc() .....	165
3.8.6.8	Drawing shapes .....	166
3.8.6.8.1	GUI_SetFuncFillCircle() .....	166
3.8.6.8.2	GUI_SetFuncDrawCircle() .....	167
3.8.6.8.3	GUI_SetFuncFillRoundedRect() .....	168
3.8.6.8.4	GUI_SetFuncDrawRoundedRect() .....	169
3.8.6.8.5	GUI_SetFuncDrawLine() .....	170
3.8.6.9	Drawing anti-aliased shapes .....	171
3.8.6.9.1	GUI_AA_SetFuncFillCircle() .....	171
3.8.6.9.2	GUI_AA_SetFuncFillPolygon() .....	172
3.8.6.9.3	GUI_AA_SetFuncDrawCircle() .....	173
3.8.6.9.4	GUI_AA_SetFuncDrawLine() .....	174
3.8.6.9.5	GUI_AA_SetFuncDrawPolyOutline() .....	175
3.8.6.9.6	GUI_AA_SetFuncDrawArc() .....	176
3.8.6.10	Bitmap scaling .....	177
3.8.6.10.1	GUI_SetFuncDrawBitmapEx() .....	177
3.8.6.11	Memory device manipulation .....	178
3.8.6.11.1	GUI_MEMDEV_SetRotateFuncLR() .....	178
3.8.6.11.2	GUI_MEMDEV_SetRotateFuncHR() .....	178
3.8.6.11.3	GUI_MEMDEV_SetBlendFunc() .....	179
3.8.6.12	JPEG decoding .....	180
3.8.6.12.1	GUI_JPEG_SetpfDrawEx() .....	181
3.9	Memory management .....	182
3.9.1	Usage .....	182
3.9.2	Block management .....	182
3.9.3	Available API functions .....	182
3.9.3.1	GUI_ALLOC_GetMaxUsedBytes() .....	183
3.9.3.2	GUI_ALLOC_GetNumFreeBytes() .....	184
3.9.3.3	GUI_ALLOC_GetMemInfo() .....	185
3.9.3.4	GUI_ALLOC_GetNumUsedBytes() .....	186
3.10	Hook functions .....	187
3.10.0.1	GUI_SetAfterExitHook() .....	188
3.10.0.2	GUI_SetAfterInitHook() .....	189
3.10.0.3	GUI_SetControlHook() .....	190
3.10.0.4	GUI_SetRefreshHook() .....	191

4	Simulation .....	192
4.1	Using the simulation .....	193
4.1.1	Rotating and mirroring the screen .....	193
4.1.2	Using the simulation with the trial version of emWin .....	193
4.1.2.1	Directory structure .....	193
4.1.2.2	Visual C++ workspace .....	194
4.1.2.3	Compiling the demo program .....	194
4.1.2.4	Compiling the samples .....	194
4.1.3	Using the simulation with the emWin source .....	195
4.1.3.1	Directory structure .....	195
4.1.3.2	Visual C++ workspace .....	196
4.1.3.3	Compiling the application .....	196
4.1.4	Advanced features of the simulation .....	197
4.1.4.1	Pause and Resume .....	197
4.1.4.2	View system info .....	197
4.1.4.3	Copy to clipboard .....	197
4.2	Device simulation .....	198
4.2.1	Generated frame view .....	198
4.2.2	Custom bitmap view .....	199
4.2.3	Window view .....	200
4.3	Device simulation API .....	201
4.3.1	Functions .....	203
4.3.1.1	SIM_GUI_Delay() .....	203
4.3.1.2	SIM_GUI_EnableModifierKey() .....	204
4.3.1.3	SIM_GUI_ExecIdle() .....	205
4.3.1.4	SIM_GUI_GetCompositeTouch() .....	206
4.3.1.5	SIM_GUI_GetTime() .....	207
4.3.1.6	SIM_GUI_IsModifierKeyEnabled() .....	208
4.3.1.7	SIM_GUI_SaveBMP() .....	209
4.3.1.8	SIM_GUI_SaveBMPEX() .....	210
4.3.1.9	SIM_GUI_SaveCompositeBMP() .....	211
4.3.1.10	SIM_GUI_SetCallback() .....	212
4.3.1.11	SIM_GUI_SetCompositeColor() .....	213
4.3.1.12	SIM_GUI_SetCompositeSize() .....	214
4.3.1.13	SIM_GUI_SetCompositeTouch() .....	215
4.3.1.14	SIM_GUI_SetLCDColorBlack() .....	216
4.3.1.15	SIM_GUI_SetLCDColorWhite() .....	216
4.3.1.16	SIM_GUI_SetLCDPos() .....	218
4.3.1.17	SIM_GUI_SetMag() .....	219
4.3.1.18	SIM_GUI_SetTransColor() .....	220
4.3.1.19	SIM_GUI_SetTransMode() .....	221
4.3.1.20	SIM_GUI_ShowDevice() .....	222
4.3.1.21	SIM_GUI_UseCustomBitmaps() .....	223
4.3.2	Data structures .....	224
4.3.2.1	SIM_GUI_INFO .....	224
4.3.3	Defines .....	225
4.3.3.1	Transparency modes .....	225
4.4	Hardkey simulation .....	226
4.4.1	Hardkey simulation API .....	226
4.4.1.1	SIM_HARDKEY_GetNum() .....	227
4.4.1.2	SIM_HARDKEY_GetState() .....	228
4.4.1.3	SIM_HARDKEY_SetCallback() .....	229
4.4.1.4	SIM_HARDKEY_SetMode() .....	230
4.4.1.5	SIM_HARDKEY_SetState() .....	231
4.5	Integrating the emWin simulation into an existing simulation .....	232
4.5.1	Directory structure .....	232
4.5.2	Using the simulation library .....	232
4.5.2.1	Modifying WinMain .....	232
4.5.2.2	Example application .....	233



4.5.3	Integration into the embOS Simulation .....	234
4.5.3.1	SIM_OS.c .....	234
4.5.3.2	Target program (main) .....	235
4.5.4	GUI simulation API .....	236
4.5.4.1	SIM_GUI_CreateLCDInfoWindow() .....	237
4.5.4.2	SIM_GUI_CreateLCDWindow() .....	238
4.5.4.3	SIM_GUI_Enable() .....	239
4.5.4.4	SIM_GUI_Exit() .....	240
4.5.4.5	SIM_GUI_Init() .....	241
4.5.4.6	SIM_GUI_SetLCDWindowHook() .....	242
5	emWin in Web Browsers: Emscripten support .....	243
5.1	Introduction .....	244
5.2	Compiling and running applications .....	244
5.3	Limitations .....	244
5.4	SVG support in browsers .....	245
5.5	GUI_EMSCRIPTEN API .....	246
5.5.1	GUI_EMSCRIPTEN_GetNow() .....	247
5.5.2	GUI_EMSCRIPTEN_GetNowTimezone() .....	248
6	Basic features .....	249
6.1	Displaying Text .....	250
6.1.1	Basic routines .....	250
6.1.2	Drawing modes .....	251
6.1.3	Position .....	253
6.1.4	Text API .....	254
6.1.4.1	Displaying text .....	256
6.1.4.1.1	GUI_DispCEOL() .....	256
6.1.4.1.2	GUI_DispChar() .....	257
6.1.4.1.3	GUI_DispCharAt() .....	258
6.1.4.1.4	GUI_DispChars() .....	259
6.1.4.1.5	GUI_DispString() .....	260
6.1.4.1.6	GUI_DispStringAt() .....	261
6.1.4.1.7	GUI_DispStringAtCEOL() .....	262
6.1.4.1.8	GUI_DispStringHCenterAt() .....	263
6.1.4.1.9	GUI_DispStringInRect() .....	264
6.1.4.1.10	GUI_DispStringInRectEx() .....	265
6.1.4.1.11	GUI_DispStringInRectWrap() .....	266
6.1.4.1.12	GUI_DispStringInRectWrapEx() .....	267
6.1.4.1.13	GUI_DispStringLength() .....	268
6.1.4.1.14	GUI_GetCharFromPos() .....	269
6.1.4.1.15	GUI_GetShowMissingCharacters() .....	270
6.1.4.1.16	GUI_ShowMissingCharacters() .....	271
6.1.4.1.17	GUI_WrapGetNumLines() .....	272
6.1.4.1.18	GUI_WrapGetPositions() .....	273
6.1.4.1.19	GUI_WrapSetSeparators() .....	274
6.1.4.2	Drawing modes .....	275
6.1.4.2.1	GUI_GetTextMode() .....	275
6.1.4.2.2	GUI_SetClearTextRectMode() .....	276
6.1.4.2.3	GUI_SetTextMode() .....	277
6.1.4.2.4	GUI_SetTextStyle() .....	278
6.1.4.3	Alignment .....	279
6.1.4.3.1	GUI_GetTextAlign() .....	279
6.1.4.3.2	GUI_SetLBorder() .....	280
6.1.4.3.3	GUI_SetTextAlign() .....	281
6.1.4.4	Position .....	282
6.1.4.4.1	GUI_DispNextLine() .....	282
6.1.4.4.2	GUI_GotoXY() .....	283
6.1.4.4.3	GUI_GotoX() .....	283

6.1.4.4.4	GUI_GotoY()	283
6.1.4.4.5	GUI_GetDispPosX()	284
6.1.4.4.6	GUI_GetDispPosY()	285
6.1.4.5	Defines	286
6.1.4.5.1	Text alignment flags	286
6.1.4.5.2	Text drawing modes	287
6.1.4.5.3	Text rotation modes	288
6.1.4.5.4	Text style flags	289
6.1.4.6	Enumerations	290
6.1.4.6.1	GUI_WRAPMODE	290
6.2	Displaying Values	291
6.2.1	Value API	292
6.2.1.1	Displaying decimal values	293
6.2.1.1.1	GUI_DispDec()	293
6.2.1.1.2	GUI_DispDecAt()	294
6.2.1.1.3	GUI_DispDecMin()	295
6.2.1.1.4	GUI_DispDecShift()	296
6.2.1.1.5	GUI_DispDecSpace()	297
6.2.1.1.6	GUI_DispSDec()	298
6.2.1.1.7	GUI_DispSDecShift()	299
6.2.1.2	Displaying floating point values	300
6.2.1.2.1	GUI_DispFloat()	300
6.2.1.2.2	GUI_DispFloatFix()	302
6.2.1.2.3	GUI_DispFloatMin()	303
6.2.1.2.4	GUI_DispSFloatFix()	304
6.2.1.2.5	GUI_DispSFloatMin()	305
6.2.1.3	Displaying binary values	306
6.2.1.3.1	GUI_DispBin()	306
6.2.1.3.2	GUI_DispBinAt()	307
6.2.1.4	Displaying hexadecimal values	308
6.2.1.4.1	GUI_DispHex()	308
6.2.1.4.2	GUI_DispHexAt()	309
6.2.1.5	GUI_GetVersionString()	310
6.3	2-D Graphic Library	311
6.3.1	Graphic API	311
6.3.1.1	Drawing related functions	318
6.3.1.1.1	GUI_AddRect()	318
6.3.1.1.2	GUI_GetClientRect()	319
6.3.1.1.3	GUI_GetClipRect()	320
6.3.1.1.4	GUI_GetDrawMode()	321
6.3.1.1.5	GUI_GetPenSize()	322
6.3.1.1.6	GUI_GetPixelIndex()	323
6.3.1.1.7	GUI_SetClipRect()	324
6.3.1.1.8	GUI_SetDrawMode()	325
6.3.1.1.9	GUI_SetPenSize()	326
6.3.1.2	Basic drawing routines	327
6.3.1.2.1	GUI_Clear()	327
6.3.1.2.2	GUI_ClearRect()	328
6.3.1.2.3	GUI_CopyRect()	329
6.3.1.2.4	GUI_DrawFrame()	330
6.3.1.2.5	GUI_DrawFrameEx()	331
6.3.1.2.6	GUI_DrawGradientH()	332
6.3.1.2.7	GUI_DrawGradientHEx()	333
6.3.1.2.8	GUI_DrawGradientV()	334
6.3.1.2.9	GUI_DrawGradientVEx()	335
6.3.1.2.10	GUI_DrawGradientRoundedH()	336
6.3.1.2.11	GUI_DrawGradientRoundedHEx()	337
6.3.1.2.12	GUI_DrawGradientRoundedV()	338
6.3.1.2.13	GUI_DrawGradientRoundedVEx()	339
6.3.1.2.14	GUI_DrawGradientMH()	340

6.3.1.2.15	GUI_DrawGradientMV()	340
6.3.1.2.16	GUI_DrawGradientMHEX()	341
6.3.1.2.17	GUI_DrawGradientMVEX()	341
6.3.1.2.18	GUI_DrawPixel()	342
6.3.1.2.19	GUI_DrawPoint()	343
6.3.1.2.20	GUI_DrawRect()	344
6.3.1.2.21	GUI_DrawRectEX()	345
6.3.1.2.22	GUI_DrawRoundedFrame()	346
6.3.1.2.23	GUI_DrawRoundedFrameEX()	347
6.3.1.2.24	GUI_DrawRoundedRect()	348
6.3.1.2.25	GUI_DrawRoundedRectEX()	349
6.3.1.2.26	GUI_FillRect()	350
6.3.1.2.27	GUI_FillRectEX()	351
6.3.1.2.28	GUI_FillRoundedRect()	352
6.3.1.2.29	GUI_FillRoundedRectEX()	353
6.3.1.2.30	GUI_InvertRect()	354
6.3.1.3	Alpha blending	355
6.3.1.3.1	GUI_EnableAlpha()	356
6.3.1.3.2	GUI_PreserveTrans()	357
6.3.1.3.3	GUI_RestoreUserAlpha()	358
6.3.1.3.4	GUI_SetAlpha()	359
6.3.1.3.5	GUI_SetUserAlpha()	360
6.3.1.4	Drawing bitmaps	361
6.3.1.4.1	GUI_DrawBitmap()	361
6.3.1.4.2	GUI_DrawBitmapEX()	362
6.3.1.4.3	GUI_DrawBitmapMag()	363
6.3.1.4.4	GUI_SetAlphaMask8888()	364
6.3.1.5	Drawing streamed bitmaps	365
6.3.1.5.1	GUI_CreateBitmapFromStream()	367
6.3.1.5.2	GUI_CreateBitmapFromStreamIDX()	368
6.3.1.5.3	GUI_CreateBitmapFromStreamRLE1()	368
6.3.1.5.4	GUI_CreateBitmapFromStreamRLE4()	368
6.3.1.5.5	GUI_CreateBitmapFromStreamRLE8()	368
6.3.1.5.6	GUI_CreateBitmapFromStream444_12()	368
6.3.1.5.7	GUI_CreateBitmapFromStream444_12_1()	368
6.3.1.5.8	GUI_CreateBitmapFromStreamM444_12()	368
6.3.1.5.9	GUI_CreateBitmapFromStreamM444_12_1()	368
6.3.1.5.10	GUI_CreateBitmapFromStream444_16()	368
6.3.1.5.11	GUI_CreateBitmapFromStreamM444_16()	368
6.3.1.5.12	GUI_CreateBitmapFromStreamA555()	368
6.3.1.5.13	GUI_CreateBitmapFromStreamAM555()	368
6.3.1.5.14	GUI_CreateBitmapFromStreamA565()	368
6.3.1.5.15	GUI_CreateBitmapFromStreamAM565()	368
6.3.1.5.16	GUI_CreateBitmapFromStream565()	368
6.3.1.5.17	GUI_CreateBitmapFromStreamM565()	368
6.3.1.5.18	GUI_CreateBitmapFromStream555()	368
6.3.1.5.19	GUI_CreateBitmapFromStreamM555()	368
6.3.1.5.20	GUI_CreateBitmapFromStreamRLE16()	368
6.3.1.5.21	GUI_CreateBitmapFromStreamRLEM16()	368
6.3.1.5.22	GUI_CreateBitmapFromStream24()	368
6.3.1.5.23	GUI_CreateBitmapFromStreamAlpha()	368
6.3.1.5.24	GUI_CreateBitmapFromStreamRLEAlpha()	368
6.3.1.5.25	GUI_CreateBitmapFromStreamRLE32()	368
6.3.1.5.26	GUI_DrawStreamedBitmap()	371
6.3.1.5.27	GUI_DrawStreamedBitmapAuto()	372
6.3.1.5.28	GUI_DrawStreamedBitmapEX()	373
6.3.1.5.29	GUI_DrawStreamedBitmapEXAuto()	374
6.3.1.5.30	GUI_DrawStreamedBitmapA555EX()	375
6.3.1.5.31	GUI_DrawStreamedBitmapAM555EX()	375
6.3.1.5.32	GUI_DrawStreamedBitmapA565EX()	375

6.3.1.5.33	GUI_DrawStreamedBitmapAM565Ex()	375
6.3.1.5.34	GUI_DrawStreamedBitmap555Ex()	375
6.3.1.5.35	GUI_DrawStreamedBitmapM555Ex()	375
6.3.1.5.36	GUI_DrawStreamedBitmap565Ex()	375
6.3.1.5.37	GUI_DrawStreamedBitmapM565Ex()	375
6.3.1.5.38	GUI_DrawStreamedBitmap24Ex()	375
6.3.1.5.39	GUI_GetStreamedBitmapInfo()	376
6.3.1.5.40	GUI_GetStreamedBitmapInfoEx()	377
6.3.1.5.41	GUI_SetStreamedBitmapHook()	378
6.3.1.6	Drawing lines	379
6.3.1.6.1	GUI_DrawHLine()	380
6.3.1.6.2	GUI_DrawLine()	381
6.3.1.6.3	GUI_DrawLineRel()	382
6.3.1.6.4	GUI_DrawLineTo()	383
6.3.1.6.5	GUI_DrawPolyLine()	384
6.3.1.6.6	GUI_DrawVLine()	385
6.3.1.6.7	GUI_GetLineStyle()	386
6.3.1.6.8	GUI_MoveRel()	387
6.3.1.6.9	GUI_MoveTo()	388
6.3.1.6.10	GUI_SetLineStyle()	389
6.3.1.7	Drawing polygons	390
6.3.1.7.1	GUI_DrawPolygon()	390
6.3.1.7.2	GUI_EnlargePolygon()	391
6.3.1.7.3	GUI_FillPolygon()	392
6.3.1.7.4	GUI_MagnifyPolygon()	393
6.3.1.7.5	GUI_RotatePolygon()	395
6.3.1.8	Drawing circles	397
6.3.1.8.1	GUI_DrawCircle()	397
6.3.1.8.2	GUI_FillCircle()	398
6.3.1.9	Drawing ellipses	399
6.3.1.9.1	GUI_DrawEllipse()	399
6.3.1.9.2	GUI_DrawEllipseXL()	400
6.3.1.9.3	GUI_FillEllipse()	401
6.3.1.10	Drawing arcs	402
6.3.1.10.1	GUI_DrawArc()	402
6.3.1.10.2	GUI_DrawArcHR()	404
6.3.1.10.3	GUI_DrawArcHREx()	405
6.3.1.11	Drawing graphs	406
6.3.1.11.1	GUI_DrawGraph()	406
6.3.1.12	Drawing barcodes	407
6.3.1.12.1	GUI_BARCODE_Draw()	407
6.3.1.12.2	GUI_BARCODE_GetXSize()	409
6.3.1.13	Drawing QR codes	410
6.3.1.13.1	Memory requirement	410
6.3.1.13.2	GUI_QR_Create()	411
6.3.1.13.3	GUI_QR_CreateFramed()	412
6.3.1.13.4	GUI_QR_Delete()	413
6.3.1.13.5	GUI_QR_Draw()	414
6.3.1.13.6	GUI_QR_GetInfo()	415
6.3.1.14	Drawing pie charts	416
6.3.1.14.1	GUI_DrawPie()	416
6.3.1.14.2	GUI_DrawPieHR()	417
6.3.1.15	Drawing splines	418
6.3.1.15.1	GUI_SPLINE_Create()	418
6.3.1.15.2	GUI_SPLINE_Delete()	419
6.3.1.15.3	GUI_SPLINE_Draw()	420
6.3.1.15.4	GUI_SPLINE_DrawAA()	421
6.3.1.15.5	GUI_SPLINE_GetY()	422
6.3.1.15.6	GUI_SPLINE_GetXSize()	423
6.3.1.16	YUV device	424

6.3.1.16.1	GUI_YUV_Create()	424
6.3.1.16.2	GUI_YUV_CreateEx()	425
6.3.1.16.3	GUI_YUV_Delete()	426
6.3.1.16.4	GUI_YUV_DeleteEx()	427
6.3.1.16.5	GUI_YUV_GetpData()	428
6.3.1.16.6	GUI_YUV_GetpDataEx()	429
6.3.1.16.7	GUI_YUV_InvalidateArea()	430
6.3.1.16.8	GUI_YUV_SetPeriod()	431
6.3.1.16.9	GUI_YUV_SetPeriodEx()	432
6.3.1.17	Data structures	433
6.3.1.17.1	GUI_ALPHA_STATE	433
6.3.1.17.2	GUI_BITMAPSTREAM_INFO	434
6.3.1.17.3	GUI_BITMAPSTREAM_PARAM	435
6.3.1.17.4	GUI_GRADIENT_INFO	436
6.3.1.17.5	GUI_POINT	437
6.3.1.17.6	GUI_QR_INFO	438
6.3.1.17.7	GUI_RECT	439
6.3.1.18	Defines	440
6.3.1.18.1	Axis values	440
6.3.1.18.2	Barcode types	441
6.3.1.18.3	Drawing modes	442
6.3.1.18.4	ECC levels for QR codes	443
6.3.1.18.5	Line styles	444
6.3.1.19	Prototypes	445
6.3.1.19.1	GUI_DTA_GET_DATA_FUNC	445
6.4	Displaying bitmap files	446
6.4.1	BMP file support	447
6.4.1.1	Supported formats	447
6.4.1.2	BMP API	447
6.4.1.2.1	Functions	449
6.4.1.2.2	Prototypes	461
6.4.2	JPEG file support	462
6.4.2.1	Supported JPEG compression methods	462
6.4.2.2	Limitations	462
6.4.2.3	Converting a JPEG file to C source	462
6.4.2.4	Displaying JPEG files	462
6.4.2.5	Hardware support for decoding JPEG files	463
6.4.2.6	IDCT configuration	463
6.4.2.7	Memory usage	463
6.4.2.8	Progressive JPEG files	464
6.4.2.9	JPEG API	464
6.4.2.9.1	Functions	465
6.4.2.9.2	Data structures	472
6.4.2.9.3	Prototypes	473
6.4.3	GIF file support	475
6.4.3.1	Converting a GIF file to C source	475
6.4.3.2	Displaying GIF files	475
6.4.3.3	Memory usage	475
6.4.3.4	GIF API	475
6.4.3.4.1	Functions	477
6.4.3.4.2	Data structures	493
6.4.3.4.3	Prototypes	495
6.4.4	PNG file support	496
6.4.4.1	Converting a PNG file to C source	496
6.4.4.2	Displaying PNG files	496
6.4.4.3	Memory usage	496
6.4.4.4	PNG API	496
6.4.4.4.1	Functions	497
6.4.4.4.2	Prototypes	503
6.5	Displaying Scalable Vector Graphics (SVG) files	504

6.5.1	Supported features .....	505
6.5.2	Configuration .....	506
6.5.2.1	API binding .....	506
6.5.2.2	Raster image module binding .....	507
6.5.2.3	SVG module initialization .....	507
6.5.3	Drivers .....	509
6.5.3.1	GUI_SVG_DRIVER_VGLITE - Vivante VGLite driver .....	510
6.5.3.2	GUI_SVG_DRIVER_OPENVG - Khronos OpenVG driver .....	512
6.5.3.2.1	Notes on the implementation .....	513
6.5.3.2.2	ShivaVG .....	514
6.5.3.3	GUI_SVG_DRIVER_NEMAVG - ThinkSilicon NemaVG driver .....	515
6.5.3.4	GUI_SVG_DRIVER_NANOVG - NanoVG driver .....	517
6.5.4	Affine transformations .....	520
6.5.4.1	Method 1: Using the basic API .....	520
6.5.4.2	Method 2: Using the handle API .....	520
6.5.4.3	Method 3: Setting a transformation matrix directly .....	521
6.5.5	Caching mode .....	522
6.5.6	Memory footprint .....	523
6.5.7	Limitations .....	524
6.5.8	GUI_MATRIX API .....	526
6.5.8.1	Functions .....	527
6.5.8.1.1	GUI_MATRIX_Equals() .....	527
6.5.8.1.2	GUI_MATRIX_GetCellPtr() .....	528
6.5.8.1.3	GUI_MATRIX_Initialize() .....	529
6.5.8.1.4	GUI_MATRIX_Identity() .....	530
6.5.8.1.5	GUI_MATRIX_Multiply() .....	531
6.5.8.1.6	GUI_MATRIX_MultiplyPoint() .....	532
6.5.8.1.7	GUI_MATRIX_Rotate() .....	533
6.5.8.1.8	GUI_MATRIX_Scale() .....	534
6.5.8.1.9	GUI_MATRIX_Shear() .....	535
6.5.8.1.10	GUI_MATRIX_Translate() .....	536
6.5.8.2	Data structures .....	537
6.5.8.2.1	GUI_MATRIX .....	537
6.5.8.2.2	GUI_POINTF .....	538
6.5.9	SVG API .....	539
6.5.9.1	Basic routines .....	543
6.5.9.1.1	GUI_SVG_Draw() .....	543
6.5.9.1.2	GUI_SVG_DrawEx() .....	544
6.5.9.1.3	GUI_SVG_DrawScaled() .....	545
6.5.9.1.4	GUI_SVG_DrawScaledEx() .....	546
6.5.9.1.5	GUI_SVG_DrawScaledRotated() .....	547
6.5.9.1.6	GUI_SVG_DrawScaledRotatedEx() .....	548
6.5.9.1.7	GUI_SVG_GetInfo() .....	549
6.5.9.1.8	GUI_SVG_GetInfoEx() .....	550
6.5.9.2	Handle-related routines .....	551
6.5.9.2.1	GUI_SVG_Create() .....	551
6.5.9.2.2	GUI_SVG_CreateEx() .....	552
6.5.9.2.3	GUI_SVG_Delete() .....	553
6.5.9.2.4	GUI_SVG_DrawH() .....	554
6.5.9.2.5	GUI_SVG_EnableCacheMode() .....	555
6.5.9.2.6	GUI_SVG_GetInfoH() .....	556
6.5.9.2.7	GUI_SVG_Identity() .....	557
6.5.9.2.8	GUI_SVG_Render() .....	558
6.5.9.2.9	GUI_SVG_Rotate() .....	559
6.5.9.2.10	GUI_SVG_RotateEx() .....	560
6.5.9.2.11	GUI_SVG_Scale() .....	561
6.5.9.2.12	GUI_SVG_ScaleToSize() .....	562
6.5.9.2.13	GUI_SVG_SetBkColor() .....	563
6.5.9.2.14	GUI_SVG_Transform() .....	564
6.5.9.2.15	GUI_SVG_Translate() .....	565

6.5.9.3	SVG module related routines .....	566
6.5.9.3.1	GUI_SVG_Enable() .....	566
6.5.9.3.2	GUI_SVG_EnablePNG() .....	567
6.5.9.3.3	GUI_SVG_EnableJPEG() .....	568
6.5.9.3.4	GUI_SVG_EnableGIF() .....	569
6.5.9.3.5	GUI_SVG_EnableBMP() .....	570
6.5.9.3.6	GUI_SVG_SetDPI() .....	571
6.5.9.3.7	GUI_SVG_SetFileBufferSize() .....	572
6.5.9.4	SVG driver related routines .....	573
6.5.9.4.1	GUI_SVG_DRIVER_BindAPI() .....	573
6.5.9.4.2	GUI_SVG_DRIVER_BindDynamicAPI() .....	574
6.5.9.4.3	GUI_SVG_DRIVER_GetSelected() .....	575
6.5.9.4.4	GUI_SVG_DRIVER_HasBoundAPI() .....	576
6.5.9.4.5	GUI_SVG_DRIVER_Select() .....	577
6.5.9.4.6	GUI_SVG_DRIVER_SetHooks() .....	578
6.5.9.4.7	GUI_SVG_DRIVER_SetVersion() .....	579
6.5.9.5	Data structures .....	580
6.5.9.5.1	GUI_SVG_BBOX .....	580
6.5.9.5.2	GUI_SVG_HOOKS .....	581
6.5.9.5.3	GUI_SVG_INFO .....	582
6.5.9.5.4	GUI_SVG_VIEWBOX .....	583
6.5.9.5.5	GUI_SVG_EGL_API_STRUCT .....	584
6.5.9.5.6	GUI_SVG_GL_API_STRUCT .....	585
6.5.9.5.7	GUI_SVG_NANOVG_API_STRUCT .....	586
6.5.9.5.8	GUI_SVG_NEMAVG_API_STRUCT .....	588
6.5.9.5.9	GUI_SVG_OPENVG_API_STRUCT .....	591
6.5.9.5.10	GUI_SVG_VGLITE_API_STRUCT .....	593
6.5.9.6	Prototypes .....	595
6.5.9.6.1	GUI_SVG_GET_DATA_FUNC .....	595
6.5.9.6.2	GUI_SVG_LOAD_API_CALLBACK .....	596
6.5.9.7	Defines .....	597
6.5.9.7.1	GUI_SVG_DECLARE_EGL_API .....	597
6.5.9.7.2	GUI_SVG_DECLARE_NANOVG_API .....	598
6.5.9.7.3	GUI_SVG_DECLARE_NEMAVG_API .....	599
6.5.9.7.4	GUI_SVG_DECLARE_OPENVG_API .....	600
6.5.9.7.5	GUI_SVG_DECLARE_OPENVG_AND_EGL_API .....	601
6.5.9.7.6	GUI_SVG_DECLARE_VGLITE_API .....	602
6.5.9.7.7	GUI_SVG_DRIVER .....	603
6.6	Colors .....	604
6.6.1	Color management .....	605
6.6.2	Logical colors .....	606
6.6.3	Switching to ARGB .....	607
6.6.3.1	Configuration .....	607
6.6.3.2	Required changes in existing applications .....	607
6.6.3.3	Configuring the BitmapConverter .....	608
6.6.4	Predefined colors .....	609
6.6.5	The color bar test routine .....	610
6.6.6	Fixed palette modes .....	611
6.6.7	Detailed fixed palette mode description .....	613
6.6.7.1	GUICC_1: 1 bpp (black and white) .....	613
6.6.7.2	GUICC_2: 2 bpp (4 grayscales) .....	613
6.6.7.3	GUICC_4: 4 bpp (16 grayscales) .....	613
6.6.7.4	GUICC_5: 5 bpp (32 grayscales) .....	613
6.6.7.5	GUICC_111: 3 bpp (2 levels per color) .....	614
6.6.7.6	GUICC_M111: 3 bpp (2 levels per color), red and blue swapped ..	614
6.6.7.7	GUICC_16: 4 bpp (16 colors) .....	614
6.6.7.8	GUICC_1616I: 8 bpp (16 colors + 4 bits alpha mask) .....	614
6.6.7.9	GUICC_222: 6 bpp (4 levels per color) .....	615
6.6.7.10	GUICC_M222: 6 bpp (4 levels per color), red and blue swapped .....	615

6.6.7.11	GUICC_M2222I: 6 bpp (4 levels per color) + 2 bit alpha, red and blue swapped .....	615
6.6.7.12	GUICC_8: 8 bpp (256 grayscales) .....	615
6.6.7.13	GUICC_233: 8 bpp .....	616
6.6.7.14	GUICC_M233: 8 bpp, red and blue swapped .....	616
6.6.7.15	GUICC_323: 8 bpp .....	617
6.6.7.16	GUICC_M323: 8 bpp, red and blue swapped .....	617
6.6.7.17	GUICC_332: 8 bpp .....	618
6.6.7.18	GUICC_M332: 8 bpp, red and blue swapped .....	618
6.6.7.19	GUICC_444_12 .....	619
6.6.7.20	GUICC_444_16 .....	619
6.6.7.21	GUICC_M444_12: red and blue swapped .....	619
6.6.7.22	GUICC_M444_16: red and blue swapped .....	620
6.6.7.23	GUICC_M444_12_1 .....	620
6.6.7.24	GUICC_M4444I: 12 bits colors + 4 bits alpha mask .....	620
6.6.7.25	GUICC_555: 15 bpp .....	620
6.6.7.26	GUICC_M555: 15 bpp, red and blue swapped .....	621
6.6.7.27	GUICC_M1555I: 15 bits colors + 1 bit transparency .....	621
6.6.7.28	GUICC_565: 16 bpp .....	621
6.6.7.29	GUICC_M565: 16 bpp, red and blue swapped .....	622
6.6.7.30	GUICC_666: 18 bpp .....	622
6.6.7.31	GUICC_M666: 18 bpp, red and blue swapped .....	622
6.6.7.32	GUICC_666_9: 18 bpp .....	622
6.6.7.33	GUICC_M666_9: 18 bpp, red and blue swapped .....	622
6.6.7.34	GUICC_666_18: 18 bpp .....	622
6.6.7.35	GUICC_M666_18: 18 bpp, red and blue swapped .....	622
6.6.7.36	GUICC_822216: 8 bpp, 2 levels per color + 8 grayscales + 16 levels of alpha blending .....	623
6.6.7.37	GUICC_84444: 8 bpp, 4 levels per color + 16 grayscales + 4(3) levels of alpha blending .....	623
6.6.7.38	GUICC_8666: 8bpp, 6 levels per color + 16 grayscales .....	624
6.6.7.39	GUICC_8666_1: 8bpp, 6 levels per color + 16 grayscales + transparency .....	624
6.6.7.40	GUICC_88666I: 16bpp - 8 bits color (6 levels per color + 16 grayscales) + 8 bits alpha blending .....	625
6.6.7.41	GUICC_888: 24 bpp .....	625
6.6.7.42	GUICC_M888: 24 bpp, red and blue swapped .....	625
6.6.7.43	GUICC_8888: 32 bpp .....	626
6.6.7.44	GUICC_8888I: 32 bpp .....	626
6.6.7.45	GUICC_M8888: 32 bpp, red and blue swapped .....	626
6.6.7.46	GUICC_M8888I: 32 bpp, red and blue swapped .....	627
6.6.7.47	GUICC_0: Custom palette mode .....	627
6.6.7.48	GUICC_1_2, GUICC_1_4, ... GUICC_1_24 .....	627
6.6.8	Application defined color conversion .....	628
6.6.9	Custom palette mode .....	629
6.6.9.1	Look-up table API .....	629
6.6.9.1.1	LCD_SetLUT() .....	630
6.6.9.1.2	LCD_SetLUTEx() .....	631
6.6.9.1.3	LCD_SetLUTEntryEx() .....	632
6.6.10	Gamma correction .....	633
6.6.11	Color API .....	633
6.6.11.1	Basic functions .....	635
6.6.11.1.1	GUI_GetBkColor() .....	635
6.6.11.1.2	GUI_GetBkColorIndex() .....	636
6.6.11.1.3	GUI_GetColor() .....	637
6.6.11.1.4	GUI_GetColorIndex() .....	638
6.6.11.1.5	GUI_GetDefaultColor() .....	639
6.6.11.1.6	GUI_GetDefaultBkColor() .....	640
6.6.11.1.7	GUI_SetBkColor() .....	641
6.6.11.1.8	GUI_SetBkColorIndex() .....	642



6.6.11.1.9	GUI_SetBlendBkColor()	643
6.6.11.1.10	GUI_SetBlendBkColorEx()	644
6.6.11.1.11	GUI_SetBlendColor()	645
6.6.11.1.12	GUI_SetBlendColorEx()	646
6.6.11.1.13	GUI_SetColor()	647
6.6.11.1.14	GUI_SetColorIndex()	648
6.6.11.1.15	GUI_SetDefaultColor()	649
6.6.11.1.16	GUI_SetDefaultBkColor()	650
6.6.11.2	Conversion functions	651
6.6.11.2.1	GUI_BlendColors()	651
6.6.11.2.2	GUI_Color2Index()	652
6.6.11.2.3	GUI_Color2VisColor()	653
6.6.11.2.4	GUI_ColorIsAvailable()	654
6.6.11.2.5	GUI_Index2Color()	655
6.7	Fonts	656
6.7.1	Introduction	656
6.7.2	Requirements	656
6.7.3	Font types	657
6.7.4	Font file formats	659
6.7.4.1	C file format	659
6.7.4.2	System Independent Font (SIF) format	659
6.7.4.3	External Bitmap Font (XBF) format	660
6.7.4.4	iType and iTypeSpark font engine support	661
6.7.4.5	TrueType Font (TTF) format	662
6.7.4.6	Glyph Bitmap Distribution Format (BDF)	663
6.7.5	Converting a TTF file to C source	664
6.7.6	Declaring custom fonts	664
6.7.7	Selecting a font	664
6.7.8	Changing the font style during run-time	665
6.7.9	Kerning	666
6.7.9.1	Standard fonts	666
6.7.9.2	Kerning with TTF fonts	667
6.7.10	Font API	668
6.7.10.1	SIF file related font functions	671
6.7.10.1.1	GUI_SIF_CreateFont()	671
6.7.10.1.2	GUI_SIF_DeleteFont()	672
6.7.10.2	TTF file related functions	673
6.7.10.2.1	GUI_TTF_AddRowBottom()	673
6.7.10.2.2	GUI_TTF_AddRowTop()	674
6.7.10.2.3	GUI_TTF_CreateFont()	675
6.7.10.2.4	GUI_TTF_CreateFontAA()	677
6.7.10.2.5	GUI_TTF_EmboldenFont()	678
6.7.10.2.6	GUI_TTF_EmboldenFontEx()	679
6.7.10.2.7	GUI_TTF_EnableKerning()	680
6.7.10.2.8	GUI_TTF_GetFamilyName()	681
6.7.10.2.9	GUI_TTF_GetStyleName()	682
6.7.10.2.10	GUI_TTF_ObliqueFont()	683
6.7.10.2.11	GUI_TTF_ObliqueFontEx()	684
6.7.10.3	XBF file related font functions	685
6.7.10.3.1	GUI_XBF_CreateFont()	685
6.7.10.3.2	GUI_XBF_DeleteFont()	686
6.7.10.4	BDF file related font functions	687
6.7.10.4.1	GUI_BDF_CreateFont()	687
6.7.10.4.2	GUI_BDF_DeleteFont()	688
6.7.10.4.3	GUI_BDF_EmboldenFont()	689
6.7.10.4.4	GUI_BDF_EmboldenFontEx()	690
6.7.10.4.5	GUI_BDF_GetFamilyName()	691
6.7.10.4.6	GUI_BDF_GetStyleName()	692
6.7.10.4.7	GUI_BDF_SetLetterSpacing()	693
6.7.10.5	FreeType related font functions	694

6.7.10.5.1	GUI_FT_DestroyCache()	694
6.7.10.5.2	GUI_FT_Done()	695
6.7.10.5.3	GUI_FT_GetMeasurementChars()	696
6.7.10.5.4	GUI_FT_SetCacheSize()	697
6.7.10.5.5	GUI_FT_SetMeasurementChars()	698
6.7.10.6	Common font-related functions	699
6.7.10.6.1	GUI_GetCharDistX()	699
6.7.10.6.2	GUI_GetDefaultFont()	700
6.7.10.6.3	GUI_GetFallbackFont()	701
6.7.10.6.4	GUI_GetFont()	702
6.7.10.6.5	GUI_GetFontDistY()	703
6.7.10.6.6	GUI_GetFontInfo()	704
6.7.10.6.7	GUI_GetFontSizeY()	705
6.7.10.6.8	GUI_GetLeadingBlankCols()	706
6.7.10.6.9	GUI_GetLeadingBlankRows()	707
6.7.10.6.10	GUI_GetStringDistX()	708
6.7.10.6.11	GUI_GetStringDistXEx()	709
6.7.10.6.12	GUI_GetTextExtend()	710
6.7.10.6.13	GUI_GetTrailingBlankCols()	711
6.7.10.6.14	GUI_GetTrailingBlankRows()	712
6.7.10.6.15	GUI_GetYDistOfFont()	713
6.7.10.6.16	GUI_GetYSizeOfFont()	714
6.7.10.6.17	GUI_IsInFont()	715
6.7.10.6.18	GUI_SetDefaultFont()	716
6.7.10.6.19	GUI_SetFallbackFont()	717
6.7.10.6.20	GUI_SetFont()	718
6.7.10.6.21	GUI_SetFuncGetFallbackFont()	719
6.7.10.7	Kerning related functions	720
6.7.10.7.1	GUI_AttachKerning()	720
6.7.10.7.2	GUI_DetachKerning()	721
6.7.10.8	Data structures	722
6.7.10.8.1	GUI_FONTINFO	722
6.7.10.8.2	GUI_TTF_CS	723
6.7.10.8.3	GUI_TTF_DATA	724
6.7.10.9	Defines	725
6.7.10.9.1	Font info flags	725
6.7.10.9.2	SIF font types	726
6.7.10.9.3	XBF font types	727
6.7.10.10	Prototypes	728
6.7.10.10.1	GUI_XBF_GET_DATA_FUNC	728
6.7.11	Character sets	729
6.7.11.1	ASCII	729
6.7.11.2	ISO 8859-1 Western Latin character set	729
6.7.11.3	Unicode	731
6.7.12	Standard fonts	732
6.7.12.1	Font identifier naming convention	732
6.7.12.2	Font file naming convention	733
6.7.12.3	Measurement, ROM-size and character set of fonts	733
6.7.12.4	Proportional fonts	733
6.7.12.4.1	Overview	733
6.7.12.4.2	Font details	734
6.7.12.4.3	Characters	736
6.7.12.5	Proportional fonts, framed	742
6.7.12.5.1	Overview	742
6.7.12.5.2	Font details	742
6.7.12.5.3	Characters	742
6.7.12.6	Monospaced fonts	742
6.7.12.6.1	Overview	742
6.7.12.6.2	Font details	743
6.7.12.6.3	Characters	743

6.7.12.7	Digit fonts (proportional) .....	747
6.7.12.7.1	Overview .....	747
6.7.12.7.2	Font details .....	748
6.7.12.7.3	Characters .....	748
6.7.12.8	Digit fonts (monospaced) .....	749
6.7.12.8.1	Overview .....	749
6.7.12.8.2	Font details .....	749
6.7.12.8.3	Characters .....	750
6.8	Animations .....	752
6.8.1	Introduction .....	752
6.8.2	Creating an animation object .....	753
6.8.3	Adding items to an animation .....	753
6.8.4	Position calculation .....	754
6.8.4.1	Custom defined position calculation .....	755
6.8.5	Executing an animation .....	756
6.8.5.1	Using a slice callback function .....	756
6.8.5.2	Animation item .....	756
6.8.5.3	Using a delete callback function .....	757
6.8.6	Animations API .....	758
6.8.6.1	Functions .....	759
6.8.6.1.1	GUI_ANIM_AddItem() .....	759
6.8.6.1.2	GUI_ANIM_AddItemById() .....	760
6.8.6.1.3	GUI_ANIM_Create() .....	761
6.8.6.1.4	GUI_ANIM_CreateWithId() .....	762
6.8.6.1.5	GUI_ANIM_Delete() .....	763
6.8.6.1.6	GUI_ANIM_DeleteAll() .....	764
6.8.6.1.7	GUI_ANIM_DeleteById() .....	765
6.8.6.1.8	GUI_ANIM_Exec() .....	766
6.8.6.1.9	GUI_ANIM_Get() .....	767
6.8.6.1.10	GUI_ANIM_GetData() .....	768
6.8.6.1.11	GUI_ANIM_GetFirst() .....	769
6.8.6.1.12	GUI_ANIM_GetItemData() .....	770
6.8.6.1.13	GUI_ANIM_GetNext() .....	771
6.8.6.1.14	GUI_ANIM_GetNumItems() .....	772
6.8.6.1.15	GUI_ANIM_GetPeriod() .....	773
6.8.6.1.16	GUI_ANIM_IsRunning() .....	774
6.8.6.1.17	GUI_ANIM_Start() .....	775
6.8.6.1.18	GUI_ANIM_StartEx() .....	776
6.8.6.1.19	GUI_ANIM_StartExId() .....	777
6.8.6.1.20	GUI_ANIM_Stop() .....	778
6.8.6.1.21	GUI_ANIM_StopById() .....	779
6.8.6.2	Data structures .....	780
6.8.6.2.1	GUI_ANIM_INFO .....	780
6.8.6.3	Defines .....	781
6.8.6.3.1	Animation states .....	781
6.9	Movies .....	782
6.9.1	Introduction .....	782
6.9.2	Requirements .....	783
6.9.3	Creating movies using MakeMovie.exe .....	784
6.9.3.1	Setting up the location of ffmpeg.exe .....	784
6.9.3.2	Available conversion options .....	785
6.9.3.3	Conversion .....	785
6.9.4	Bitmap-EMF files .....	786
6.9.4.1	Sample program to run EMF from external memory .....	787
6.9.5	emWin Movie Player .....	790
6.9.6	Movies API .....	791
6.9.6.1	Functions .....	793
6.9.6.1.1	GUI_MOVIE_Create() .....	793
6.9.6.1.2	GUI_MOVIE_CreateEx() .....	794
6.9.6.1.3	GUI_MOVIE_Delete() .....	795

6.9.6.1.4	GUI_MOVIE_DrawFrame()	796
6.9.6.1.5	GUI_MOVIE_GetFrameIndex()	797
6.9.6.1.6	GUI_MOVIE_GetInfo()	798
6.9.6.1.7	GUI_MOVIE_GetInfoEx()	799
6.9.6.1.8	GUI_MOVIE_GetInfoH()	800
6.9.6.1.9	GUI_MOVIE_GetNumFrames()	801
6.9.6.1.10	GUI_MOVIE_GetPos()	802
6.9.6.1.11	GUI_MOVIE_GotoFrame()	803
6.9.6.1.12	GUI_MOVIE_IsPlaying()	804
6.9.6.1.13	GUI_MOVIE_Pause()	805
6.9.6.1.14	GUI_MOVIE_Play()	806
6.9.6.1.15	GUI_MOVIE_SetPeriod()	807
6.9.6.1.16	GUI_MOVIE_SetpfNotify()	808
6.9.6.1.17	GUI_MOVIE_SetPos()	809
6.9.6.1.18	GUI_MOVIE_SetSecondHandle()	810
6.9.6.1.19	GUI_MOVIE_Show()	811
6.9.6.2	Data structures	812
6.9.6.2.1	GUI_MOVIE_INFO	812
6.9.6.3	Defines	813
6.9.6.3.1	Movie notifications	813
6.9.6.4	Prototypes	814
6.9.6.4.1	GUI_MOVIE_GET_DATA_FUNC	814
6.10	Pointer Input Devices	815
6.10.1	Description	815
6.10.2	Pointer input device API	815
6.10.2.1	Functions	816
6.10.2.1.1	GUI_PID_GetCurrentState()	816
6.10.2.1.2	GUI_PID_GetState()	817
6.10.2.1.3	GUI_PID_IsEmpty()	818
6.10.2.1.4	GUI_PID_IsPressed()	819
6.10.2.1.5	GUI_PID_SetHook()	820
6.10.2.1.6	GUI_PID_StoreState()	821
6.10.2.2	Data structures	822
6.10.2.2.1	GUI_PID_STATE	822
6.10.3	Mouse driver	823
6.10.3.1	Generic mouse driver API	823
6.10.3.1.1	GUI_MOUSE_GetState()	824
6.10.3.1.2	GUI_MOUSE_StoreState()	825
6.10.3.2	PS2 mouse driver	826
6.10.3.2.1	Using the PS2 mouse driver	826
6.10.3.2.2	PS2 mouse driver API	826
6.10.4	Touch screen driver	829
6.10.4.1	Generic touch screen API	829
6.10.4.1.1	GUI_TOUCH_GetState()	830
6.10.4.1.2	GUI_TOUCH_StoreState()	831
6.10.4.1.3	GUI_TOUCH_StoreStateEx()	832
6.10.4.2	The analog touch screen driver	833
6.10.4.2.1	Setting up the analog touch screen	833
6.10.4.2.2	Runtime calibration	835
6.10.4.2.3	Hardware routines	836
6.10.4.2.4	Driver API for analog touch screens	840
6.10.4.2.5	Configuring the analog touch-screen driver	845
6.10.5	Touch screen calibration	846
6.10.5.1	Using calibration with the analog touch screen driver	847
6.10.5.2	Using calibration with a custom touch screen driver	847
6.10.5.3	Calibration API	848
6.10.5.3.1	GUI_TOUCH_CalcCoefficients()	849
6.10.5.3.2	GUI_TOUCH_CalibratePoint()	850
6.10.5.3.3	GUI_TOUCH_EnableCalibration()	851
6.10.5.3.4	GUI_TOUCH_TransformPoint()	852

6.10.6	Joystick input example .....	853
6.11	Info about screen changes .....	855
6.11.1	API .....	855
6.11.1.1	DIRTYDEVICE .....	856
6.11.1.1.1	GUI_DIRTYDEVICE_Create() .....	856
6.11.1.1.2	GUI_DIRTYDEVICE_CreateEx() .....	857
6.11.1.1.3	GUI_DIRTYDEVICE_Delete() .....	858
6.11.1.1.4	GUI_DIRTYDEVICE_DeleteEx() .....	859
6.11.1.1.5	GUI_DIRTYDEVICE_Fetch() .....	860
6.11.1.1.6	GUI_DIRTYDEVICE_FetchEx() .....	861
6.11.1.2	DIRTYTILES .....	862
6.11.1.2.1	GUI_DIRTYTILES_CleanUp() .....	862
6.11.1.2.2	GUI_DIRTYTILES_CleanUpEx() .....	863
6.11.1.2.3	GUI_DIRTYTILES_Create() .....	864
6.11.1.2.4	GUI_DIRTYTILES_CreateEx() .....	865
6.11.1.2.5	GUI_DIRTYTILES_Fetch() .....	866
6.11.1.2.6	GUI_DIRTYTILES_FetchEx() .....	867
6.11.2	Data structures .....	868
6.11.2.1	GUI_DIRTYDEVICE_INFO .....	868
6.12	Multiple Buffering .....	869
6.12.1	How it works .....	869
6.12.1.1	Double Buffering .....	870
6.12.1.2	Triple Buffering .....	870
6.12.2	Optimizing CPU load .....	870
6.12.3	Requirements .....	870
6.12.4	Limitations .....	870
6.12.5	Configuration .....	871
6.12.5.1	LCD_X_Config() .....	871
6.12.5.2	LCD_X_DisplayDriver() .....	872
6.12.6	Automatic use of multiple buffers with the WM .....	874
6.12.7	Multiple Buffering API .....	875
6.12.7.1	GUI_MULTIBUF_Begin() .....	876
6.12.7.2	GUI_MULTIBUF_BeginEx() .....	877
6.12.7.3	GUI_MULTIBUF_Config() .....	878
6.12.7.4	GUI_MULTIBUF_ConfigEx() .....	879
6.12.7.5	GUI_MULTIBUF_Confirm() .....	880
6.12.7.6	GUI_MULTIBUF_ConfirmEx() .....	881
6.12.7.7	GUI_MULTIBUF_End() .....	882
6.12.7.8	GUI_MULTIBUF_EndEx() .....	883
6.12.7.9	GUI_MULTIBUF_GetNumBuffers() .....	884
6.12.7.10	GUI_MULTIBUF_GetNumBuffersEx() .....	885
6.12.7.11	GUI_MULTIBUF_UseSingleBuffer() .....	886
6.13	Keyboard Input .....	887
6.13.1	Description .....	887
6.13.2	Driver layer API .....	887
6.13.2.1	GUI_StoreKeyMsg() .....	888
6.13.2.2	GUI_SendKeyMsg() .....	889
6.13.3	Application layer API .....	890
6.13.3.1	GUI_ClearKeyBuffer() .....	891
6.13.3.2	GUI_GetKey() .....	892
6.13.3.3	GUI_GetKeyPressed() .....	893
6.13.3.4	GUI_GetKeyState() .....	894
6.13.3.5	GUI_StoreKey() .....	895
6.13.3.6	GUI_WaitKey() .....	896
6.13.4	Data structure .....	897
6.13.4.1	GUI_KEY_STATE .....	897
6.14	Language Support .....	898
6.14.1	Unicode .....	898
6.14.1.1	UTF-8 encoding .....	898
6.14.1.2	Unicode characters .....	899

6.14.1.3	UTF-8 strings .....	899
6.14.1.3.1	Using U2C.exe to convert UTF-8 text into C code .....	899
6.14.1.4	Unicode API .....	901
6.14.1.4.1	UTF-8 functions .....	902
6.14.1.4.2	Double byte functions .....	914
6.14.2	Text- and language resource files .....	915
6.14.2.1	Unicode support .....	915
6.14.2.2	Loading files from RAM .....	915
6.14.2.3	Loading files from non addressable areas .....	915
6.14.2.4	Rules for CSV files .....	915
6.14.2.5	Rules for text files .....	915
6.14.2.6	Text- and language resource file API .....	917
6.14.2.6.1	Functions .....	918
6.14.2.6.2	Prototypes .....	935
6.14.3	Right to left- and bidirectional text .....	936
6.14.3.1	Bidirectional text algorithm .....	936
6.14.3.2	Basic text direction .....	936
6.14.3.3	Mirroring .....	936
6.14.3.4	ROM and stack requirement .....	936
6.14.3.5	Maximum characters per line .....	937
6.14.4	Arabic support .....	938
6.14.4.1	Notation forms .....	938
6.14.4.2	Ligatures .....	939
6.14.4.3	How to enable Arabic support .....	940
6.14.4.4	Example .....	940
6.14.4.5	Font files used with Arabic text .....	940
6.14.5	Thai language support .....	941
6.14.5.1	Requirements .....	941
6.14.5.2	How to enable Thai support .....	941
6.14.5.3	Example .....	941
6.14.5.4	Font files used with Thai text .....	941
6.14.6	Shift JIS support .....	942
6.14.6.1	Creating Shift JIS fonts .....	942
6.14.7	Limitations .....	942
6.15	Timing- and execution-related functions .....	943
6.15.1	Timing and execution API .....	943
6.15.1.1	GUI_Delay() .....	944
6.15.1.2	GUI_Exec() .....	945
6.15.1.3	GUI_Exec1() .....	946
6.15.1.4	GUI_GetTime() .....	947
6.15.1.5	GUI_GetTimeSlice() .....	948
6.15.1.6	GUI_SetTimeSlice() .....	949
6.15.2	Verbosity API .....	950
6.15.2.1	GUI_ErrorOut() .....	951
6.15.2.2	GUI_Log() .....	952
6.15.2.3	GUI_Warn() .....	953
6.15.3	Timer API .....	954
6.15.3.1	GUI_TIMER_Create() .....	955
6.15.3.2	GUI_TIMER_Delete() .....	956
6.15.3.3	GUI_TIMER_Restart() .....	957
6.15.3.4	GUI_TIMER_SetPeriod() .....	958
<b>7</b>	<b>Advanced features .....</b>	<b>959</b>
7.1	The Window Manager (WM) .....	960
7.1.1	Description of terms .....	960
7.1.2	Callback mechanism, invalidation, rendering and keyboard input .....	963
7.1.2.1	Rendering using callbacks .....	963
7.1.2.2	Overwriting callback functions .....	964
7.1.2.3	Background window redrawing and callback .....	965

7.1.2.4	Invalidation .....	965
7.1.2.5	Tiling mechanism .....	965
7.1.2.6	Rendering of transparent windows .....	967
7.1.2.7	Automatic use of Memory Devices .....	967
7.1.2.8	Performance gain with Static Memory Devices .....	967
7.1.2.9	Automatic use of multiple frame buffers .....	967
7.1.2.10	Automatic use of display driver cache .....	967
7.1.2.11	Keyboard input .....	968
7.1.3	Motion support .....	969
7.1.3.1	Enabling motion support of the WM .....	969
7.1.3.2	Basic motion support for a window .....	969
7.1.3.2.1	Using creation flags .....	969
7.1.3.2.2	Using API function .....	969
7.1.3.3	Motion processing by application .....	969
7.1.3.3.1	WM_MOTION message and WM_MOTION_INFO .....	970
7.1.3.4	Motion support for circular moves .....	971
7.1.3.5	Widgets with motion support .....	971
7.1.4	Window manager and multiple layers .....	972
7.1.4.1	Drawing operations .....	972
7.1.4.2	Window relationship .....	972
7.1.4.3	Semi-transparency .....	972
7.1.4.4	Touch input .....	972
7.1.4.5	Memory devices .....	972
7.1.5	ToolTips .....	973
7.1.5.1	How they work .....	973
7.1.5.2	Creating ToolTips .....	973
7.1.5.2.1	Creating ToolTips for dialog items .....	973
7.1.5.2.2	Creating ToolTips for simple windows .....	974
7.1.6	Messages .....	975
7.1.6.1	Message structure .....	975
7.1.6.2	List of messages .....	975
7.1.6.3	System-defined messages .....	975
7.1.6.3.1	WM_CREATE .....	975
7.1.6.3.2	WM_DELETE .....	975
7.1.6.3.3	WM_GET_ID .....	975
7.1.6.3.4	WM_GET_INSIDE_RECT .....	975
7.1.6.3.5	WM_INIT_DIALOG .....	976
7.1.6.3.6	WM_KEY .....	976
7.1.6.3.7	WM_MOVE .....	976
7.1.6.3.8	WM_NOTIFY_PARENT .....	976
7.1.6.3.9	WM_NOTIFY_VIS_CHANGED .....	976
7.1.6.3.10	WM_PAINT .....	977
7.1.6.3.11	WM_POST_PAINT .....	977
7.1.6.3.12	WM_PRE_PAINT .....	977
7.1.6.3.13	WM_SET_CALLBACK .....	977
7.1.6.3.14	WM_SET_FOCUS .....	978
7.1.6.3.15	WM_SET_ID .....	978
7.1.6.3.16	WM_SIZE .....	978
7.1.6.3.17	WM_TIMER .....	978
7.1.6.3.18	WM_USER_DATA .....	978
7.1.6.4	Pointer input device (PID) messages .....	978
7.1.6.4.1	WM_MOTION .....	979
7.1.6.4.2	WM_MOUSEOVER .....	979
7.1.6.4.3	WM_MOUSEOVER_END .....	979
7.1.6.4.4	WM_PID_STATE_CHANGED .....	979
7.1.6.4.5	WM_TOUCH .....	979
7.1.6.4.6	WM_TOUCH_CHILD .....	980
7.1.6.4.7	Example .....	980
7.1.6.5	System-defined notification codes .....	981
7.1.6.6	Application-defined messages .....	981

7.1.7	Configuration options .....	982
7.1.7.1	WM_SUPPORT_NOTIFY_VIS_CHANGED .....	982
7.1.7.2	WM_SUPPORT_TRANSPARENCY .....	982
7.1.8	WM API .....	983
7.1.8.1	Using the WM API functions .....	988
7.1.8.2	Basic functions .....	989
7.1.8.2.1	WM_Activate() .....	989
7.1.8.2.2	WM_AttachWindow() .....	990
7.1.8.2.3	WM_AttachWindowAt() .....	991
7.1.8.2.4	WM_BringToBottom() .....	992
7.1.8.2.5	WM_BringToTop() .....	993
7.1.8.2.6	WM_BroadcastMessage() .....	994
7.1.8.2.7	WM_ClrHasTrans() .....	995
7.1.8.2.8	WM_CreateWindow() .....	996
7.1.8.2.9	WM_CreateWindowAsChild() .....	997
7.1.8.2.10	WM_Deactivate() .....	998
7.1.8.2.11	WM_DefaultProc() .....	999
7.1.8.2.12	WM_DeleteWindow() .....	1000
7.1.8.2.13	WM_DeleteWindowSecure() .....	1001
7.1.8.2.14	WM_DetachWindow() .....	1002
7.1.8.2.15	WM_DisableWindow() .....	1003
7.1.8.2.16	WM_EnableWindow() .....	1004
7.1.8.2.17	WM_Exec() .....	1005
7.1.8.2.18	WM_Exec1() .....	1006
7.1.8.2.19	WM_ForEachDesc() .....	1007
7.1.8.2.20	WM_GetActiveWindow() .....	1009
7.1.8.2.21	WM_GetCallback() .....	1010
7.1.8.2.22	WM_GetCapture() .....	1011
7.1.8.2.23	WM_GetChild() .....	1012
7.1.8.2.24	WM_GetClientRect() .....	1013
7.1.8.2.25	WM_GetClientRectEx() .....	1014
7.1.8.2.26	WM_GetDesktopWindow() .....	1015
7.1.8.2.27	WM_GetDesktopWindowEx() .....	1016
7.1.8.2.28	WM_GetDialogItem() .....	1017
7.1.8.2.29	WM_GetFirstChild() .....	1018
7.1.8.2.30	WM_GetFocusedWindow() .....	1019
7.1.8.2.31	WM_GetHasTrans() .....	1020
7.1.8.2.32	WM_GetInvalidRect() .....	1021
7.1.8.2.33	WM_GetModalLayer() .....	1022
7.1.8.2.34	WM_GetModalWindow() .....	1023
7.1.8.2.35	WM_GetNextSibling() .....	1024
7.1.8.2.36	WM_GetNumInvalidWindows() .....	1025
7.1.8.2.37	WM_GetOrgX() .....	1026
7.1.8.2.38	WM_GetOrgY() .....	1026
7.1.8.2.39	WM_GetParent() .....	1027
7.1.8.2.40	WM_GetPrevSibling() .....	1028
7.1.8.2.41	WM_GetStayOnTop() .....	1029
7.1.8.2.42	WM_GetUserData() .....	1030
7.1.8.2.43	WM_GetWindowOrgX() .....	1031
7.1.8.2.44	WM_GetWindowOrgY() .....	1031
7.1.8.2.45	WM_GetWindowRect() .....	1032
7.1.8.2.46	WM_GetWindowRectEx() .....	1033
7.1.8.2.47	WM_GetWindowSizeX() .....	1034
7.1.8.2.48	WM_GetWindowSizeY() .....	1034
7.1.8.2.49	WM_HasCaptured() .....	1035
7.1.8.2.50	WM_HasFocus() .....	1036
7.1.8.2.51	WM_HideWindow() .....	1037
7.1.8.2.52	WM_InvalidateArea() .....	1038
7.1.8.2.53	WM_InvalidateRect() .....	1039
7.1.8.2.54	WM_InvalidateWindow() .....	1040



7.1.8.2.55	WM_IsCompletelyCovered()	1041
7.1.8.2.56	WM_IsCompletelyVisible()	1042
7.1.8.2.57	WM_IsEnabled()	1043
7.1.8.2.58	WM_IsUntouchable()	1044
7.1.8.2.59	WM_IsVisible()	1045
7.1.8.2.60	WM_IsWindow()	1046
7.1.8.2.61	WM_MakeModal()	1047
7.1.8.2.62	WM_MoveChildTo()	1048
7.1.8.2.63	WM_MoveTo()	1049
7.1.8.2.64	WM_MoveWindow()	1050
7.1.8.2.65	WM_NotifyParent()	1051
7.1.8.2.66	WM_Paint()	1052
7.1.8.2.67	WM_PaintWindowAndDescs()	1053
7.1.8.2.68	WM_Rect2Client()	1054
7.1.8.2.69	WM_Rect2Screen()	1055
7.1.8.2.70	WM_ReleaseCapture()	1056
7.1.8.2.71	WM_ResizeWindow()	1057
7.1.8.2.72	WM_Screen2hWin()	1058
7.1.8.2.73	WM_Screen2hWinEx()	1059
7.1.8.2.74	WM_SelectWindow()	1060
7.1.8.2.75	WM_SendMessage()	1061
7.1.8.2.76	WM_SendMessageNoPara()	1062
7.1.8.2.77	WM_SendToParent()	1063
7.1.8.2.78	WM_SetCallback()	1064
7.1.8.2.79	WM_SetCapture()	1065
7.1.8.2.80	WM_SetCaptureMove()	1066
7.1.8.2.81	WM_SetCreateFlags()	1067
7.1.8.2.82	WM_SetDesktopColor()	1068
7.1.8.2.83	WM_SetDesktopColorEx()	1069
7.1.8.2.84	WM_SetEnableState()	1070
7.1.8.2.85	WM_SetFocus()	1071
7.1.8.2.86	WM_SetHasTrans()	1072
7.1.8.2.87	WM_SetId()	1073
7.1.8.2.88	WM_SetModalLayer()	1074
7.1.8.2.89	WM_SetpfPollPID()	1075
7.1.8.2.90	WM_SetSize()	1076
7.1.8.2.91	WM_SetUntouchable()	1077
7.1.8.2.92	WM_SetWindowPos()	1078
7.1.8.2.93	WM_SetXSize()	1079
7.1.8.2.94	WM_SetYSize()	1080
7.1.8.2.95	WM_SetStayOnTop()	1081
7.1.8.2.96	WM_SetTransState()	1082
7.1.8.2.97	WM_SetUserClipRect()	1083
7.1.8.2.98	WM_SetUserData()	1084
7.1.8.2.99	WM_ShowWindow()	1085
7.1.8.2.100	WM_Update()	1086
7.1.8.2.101	WM_UpdateWindowAndDescs()	1087
7.1.8.2.102	WM_ValidateRect()	1088
7.1.8.2.103	WM_ValidateWindow()	1089
7.1.8.2.104	WM_XY2Screen()	1090
7.1.8.2.105	WM_XY2Client()	1091
7.1.8.3	Motion support	1092
7.1.8.3.1	WM_MOTION_Enable()	1092
7.1.8.3.2	WM_MOTION_SetDeceleration()	1093
7.1.8.3.3	WM_MOTION_SetDefaultPeriod()	1094
7.1.8.3.4	WM_MOTION_SetMotion()	1095
7.1.8.3.5	WM_MOTION_SetMoveable()	1096
7.1.8.3.6	WM_MOTION_SetMovement()	1097
7.1.8.3.7	WM_MOTION_SetSpeed()	1098
7.1.8.3.8	WM_MOTION_SetThreshold()	1099

7.1.8.4	ToolTip related functions .....	1100
7.1.8.4.1	WM_TOOLTIP_AddTool() .....	1100
7.1.8.4.2	WM_TOOLTIP_Create() .....	1101
7.1.8.4.3	WM_TOOLTIP_Delete() .....	1102
7.1.8.4.4	WM_TOOLTIP_SetDefaultColor() .....	1103
7.1.8.4.5	WM_TOOLTIP_SetDefaultFont() .....	1104
7.1.8.4.6	WM_TOOLTIP_SetDefaultPeriod() .....	1105
7.1.8.5	Multiple Buffering support .....	1106
7.1.8.5.1	WM_MULTIBUF_Enable() .....	1106
7.1.8.6	Memory Device support (optional) .....	1107
7.1.8.6.1	WM_DisableMemdev() .....	1107
7.1.8.6.2	WM_EnableMemdev() .....	1108
7.1.8.7	Timer related .....	1109
7.1.8.7.1	WM_CreateTimer() .....	1109
7.1.8.7.2	WM_DeleteTimer() .....	1110
7.1.8.7.3	WM_GetTimerId() .....	1111
7.1.8.7.4	WM_RestartTimer() .....	1112
7.1.8.8	Widget related functions .....	1113
7.1.8.8.1	WM_GetClientWindow() .....	1113
7.1.8.8.2	WM_GetContentRect() .....	1114
7.1.8.8.3	WM_GetContentRectEx() .....	1115
7.1.8.8.4	WM_GetId() .....	1116
7.1.8.8.5	WM_GetInsideRect() .....	1117
7.1.8.8.6	WM_GetInsideRectEx() .....	1118
7.1.8.8.7	WM_GetScrollbarH() .....	1119
7.1.8.8.8	WM_GetScrollbarV() .....	1120
7.1.8.8.9	WM_GetScrollerV() .....	1121
7.1.8.8.10	WM_GetScrollerH() .....	1122
7.1.8.8.11	WM_GetScrollPartner() .....	1123
7.1.8.8.12	WM_GetScrollPosH() .....	1124
7.1.8.8.13	WM_GetScrollPosV() .....	1125
7.1.8.8.14	WM_GetScrollState() .....	1126
7.1.8.8.15	WM_SetScrollPosH() .....	1127
7.1.8.8.16	WM_SetScrollPosV() .....	1128
7.1.8.8.17	WM_SetScrollState() .....	1129
7.1.8.9	Data structures .....	1130
7.1.8.9.1	TOOLTIP_INFO .....	1130
7.1.8.9.2	WM_KEY_INFO .....	1131
7.1.8.9.3	WM_MESSAGE .....	1132
7.1.8.9.4	WM_MOTION_INFO .....	1133
7.1.8.9.5	WM_MOVE_INFO .....	1134
7.1.8.9.6	WM_PID_STATE_CHANGED_INFO .....	1135
7.1.8.9.7	WM_SCROLL_STATE .....	1136
7.1.8.10	Defines .....	1137
7.1.8.10.1	Message IDs .....	1137
7.1.8.10.2	Motion flags .....	1139
7.1.8.10.3	Motion messages .....	1140
7.1.8.10.4	Motion overlap flags .....	1141
7.1.8.10.5	Notification codes .....	1142
7.1.8.10.6	ToolTip color indexes .....	1144
7.1.8.10.7	ToolTip period indexes .....	1145
7.1.8.10.8	Window create flags .....	1146
7.1.9	Example .....	1149
7.2	Widgets (window objects) .....	1151
7.2.1	Some basics .....	1151
7.2.1.1	Available widgets .....	1151
7.2.1.2	Custom widget types .....	1155
7.2.1.3	Understanding the redrawing mechanism .....	1155
7.2.1.4	How to use widgets .....	1155
7.2.2	Configuration options .....	1157

7.2.3	Widget IDs .....	1158
7.2.4	General widget API .....	1159
7.2.4.1	WM routines used for widgets .....	1159
7.2.4.2	Common routines .....	1159
7.2.4.2.1	<WIDGET>_Callback() .....	1160
7.2.4.2.2	<WIDGET>_CreateIndirect() .....	1161
7.2.4.2.3	<WIDGET>_CreateUser() .....	1162
7.2.4.2.4	WIDGET_GetMinTimePerFrame() .....	1163
7.2.4.2.5	WIDGET_GetType() .....	1164
7.2.4.2.6	<WIDGET>_GetUserData() .....	1165
7.2.4.2.7	<WIDGET>_SetUserData() .....	1166
7.2.4.2.8	WIDGET_EnableStreamAuto() .....	1167
7.2.4.2.9	WIDGET_GetDefaultEffect() .....	1168
7.2.4.2.10	WIDGET_SetDefaultEffect() .....	1169
7.2.4.2.11	WIDGET_SetEffect() .....	1170
7.2.4.2.12	WIDGET_SetFocusable() .....	1171
7.2.4.2.13	WIDGET_SetMinTimePerFrame() .....	1172
7.2.4.3	Widget type IDs .....	1173
7.2.4.4	User drawn widgets .....	1175
7.2.5	BUTTON: Button widget .....	1177
7.2.5.1	Configuration options .....	1177
7.2.5.1.1	BUTTON_REACT_ON_LEVEL .....	1177
7.2.5.1.2	BUTTON_BKCOLOR0_DEFAULT, BUTTON_BKCOLOR1_DEFAULT .....	1178
7.2.5.2	Predefined IDs .....	1178
7.2.5.3	Notification codes .....	1178
7.2.5.4	Keyboard reaction .....	1179
7.2.5.5	BUTTON API .....	1179
7.2.5.5.1	Functions .....	1181
7.2.5.5.2	Defines .....	1224
7.2.5.6	Examples .....	1226
7.2.6	CHECKBOX: Checkbox widget .....	1227
7.2.6.1	Configuration options .....	1227
7.2.6.2	Predefined IDs .....	1228
7.2.6.3	Notification codes .....	1228
7.2.6.4	Keyboard reaction .....	1228
7.2.6.5	CHECKBOX API .....	1229
7.2.6.5.1	Functions .....	1231
7.2.6.5.2	Defines .....	1274
7.2.6.6	Example .....	1276
7.2.7	DROPDOWN: Dropdown widget .....	1277
7.2.7.1	Configuration options .....	1277
7.2.7.2	Predefined IDs .....	1278
7.2.7.3	Notification codes .....	1278
7.2.7.4	Keyboard reaction .....	1278
7.2.7.5	DROPDOWN API .....	1279
7.2.7.5.1	Functions .....	1281
7.2.7.5.2	Defines .....	1328
7.2.7.6	Example .....	1331
7.2.8	EDIT: Edit widget .....	1332
7.2.8.1	Configuration options .....	1332
7.2.8.2	Predefined IDs .....	1332
7.2.8.3	Notification codes .....	1333
7.2.8.4	Keyboard reaction .....	1333
7.2.8.5	EDIT API .....	1334
7.2.8.5.1	Functions .....	1336
7.2.8.5.2	Defines .....	1392
7.2.8.6	Examples .....	1394
7.2.9	FRAMEWIN: Frame window widget .....	1395
7.2.9.1	Structure of the frame window .....	1396

7.2.9.2	Configuration options .....	1397
7.2.9.3	Keyboard reaction .....	1397
7.2.9.4	FRAMEWIN API .....	1397
7.2.9.4.1	Functions .....	1400
7.2.9.4.2	Defines .....	1452
7.2.9.5	Example .....	1455
7.2.10	GAUGE: Gauge widget .....	1456
7.2.10.1	Configuration options .....	1456
7.2.10.2	Predefined IDs .....	1456
7.2.10.3	Notification codes .....	1457
7.2.10.4	Keyboard reaction .....	1457
7.2.10.5	GAUGE API .....	1457
7.2.10.5.1	Functions .....	1459
7.2.10.5.2	Defines .....	1476
7.2.11	GRAPH: Graph widget .....	1477
7.2.11.1	Structure of the graph widget .....	1477
7.2.11.2	Creating and deleting a graph widget .....	1478
7.2.11.3	Drawing process .....	1478
7.2.11.4	Supported types of curves .....	1478
7.2.11.4.1	GRAPH_DATA_XY .....	1479
7.2.11.4.2	GRAPH_DATA_YT .....	1479
7.2.11.5	Configuration options .....	1479
7.2.11.5.1	Graph widget .....	1479
7.2.11.5.2	Scale object .....	1479
7.2.11.6	Predefined IDs .....	1480
7.2.11.7	Keyboard reaction .....	1480
7.2.11.8	GRAPH API .....	1480
7.2.11.8.1	Common routines .....	1483
7.2.11.8.2	GRAPH_DATA_YT related routines .....	1509
7.2.11.8.3	GRAPH_DATA_XY related routines .....	1518
7.2.11.8.4	Scale related routines .....	1532
7.2.11.8.5	Defines .....	1541
7.2.11.9	Examples .....	1546
7.2.12	HEADER: Header widget .....	1547
7.2.12.1	Configuration options .....	1547
7.2.12.2	Notification codes .....	1548
7.2.12.3	Keyboard reaction .....	1548
7.2.12.4	HEADER API .....	1548
7.2.12.4.1	HEADER_AddItem() .....	1551
7.2.12.4.2	HEADER_Create() .....	1552
7.2.12.4.3	HEADER_CreateAttached() .....	1553
7.2.12.4.4	HEADER_CreateEx() .....	1554
7.2.12.4.5	HEADER_CreateIndirect() .....	1555
7.2.12.4.6	HEADER_CreateUser() .....	1556
7.2.12.4.7	HEADER_DeleteItem() .....	1557
7.2.12.4.8	HEADER_GetBkColor() .....	1558
7.2.12.4.9	HEADER_GetBorderH() .....	1559
7.2.12.4.10	HEADER_GetBorderV() .....	1560
7.2.12.4.11	HEADER_GetColumnFromPos() .....	1561
7.2.12.4.12	HEADER_GetDefaultBkColor() .....	1562
7.2.12.4.13	HEADER_GetDefaultBorderH() .....	1563
7.2.12.4.14	HEADER_GetDefaultBorderV() .....	1564
7.2.12.4.15	HEADER_GetDefaultCursor() .....	1565
7.2.12.4.16	HEADER_GetDefaultFont() .....	1566
7.2.12.4.17	HEADER_GetDefaultTextColor() .....	1567
7.2.12.4.18	HEADER_GetFont() .....	1568
7.2.12.4.19	HEADER_GetHeight() .....	1569
7.2.12.4.20	HEADER_GetItemText() .....	1570
7.2.12.4.21	HEADER_GetItemWidth() .....	1571
7.2.12.4.22	HEADER_GetNumItems() .....	1572

7.2.12.4.23	HEADER_GetSel()	1573
7.2.12.4.24	HEADER_GetTextColor()	1574
7.2.12.4.25	HEADER_GetUserData()	1575
7.2.12.4.26	HEADER_SetBitmap()	1576
7.2.12.4.27	HEADER_SetBitmapEx()	1577
7.2.12.4.28	HEADER_SetBkColor()	1578
7.2.12.4.29	HEADER_SetBMP()	1579
7.2.12.4.30	HEADER_SetBMPEX()	1580
7.2.12.4.31	HEADER_SetBorderH()	1581
7.2.12.4.32	HEADER_SetBorderV()	1582
7.2.12.4.33	HEADER_SetDefaultBkColor()	1583
7.2.12.4.34	HEADER_SetDefaultBorderH()	1584
7.2.12.4.35	HEADER_SetDefaultBorderV()	1585
7.2.12.4.36	HEADER_SetDefaultCursor()	1586
7.2.12.4.37	HEADER_SetDefaultFont()	1587
7.2.12.4.38	HEADER_SetDefaultTextColor()	1588
7.2.12.4.39	HEADER_SetDragLimit()	1589
7.2.12.4.40	HEADER_SetFixed()	1590
7.2.12.4.41	HEADER_SetFont()	1591
7.2.12.4.42	HEADER_SetHeight()	1592
7.2.12.4.43	HEADER_SetItemText()	1593
7.2.12.4.44	HEADER_SetItemWidth()	1594
7.2.12.4.45	HEADER_SetScrollPos()	1595
7.2.12.4.46	HEADER_SetStreamedBitmap()	1596
7.2.12.4.47	HEADER_SetStreamedBitmapEx()	1597
7.2.12.4.48	HEADER_SetTextAlign()	1598
7.2.12.4.49	HEADER_SetTextColor()	1599
7.2.12.4.50	HEADER_SetUserData()	1600
7.2.12.5	Example	1601
7.2.13	ICONVIEW: Icon view widget	1602
7.2.13.1	Configuration options	1602
7.2.13.2	Predefined IDs	1603
7.2.13.3	Notification codes	1603
7.2.13.4	Keyboard reaction	1603
7.2.13.5	ICONVIEW API	1604
7.2.13.5.1	Functions	1606
7.2.13.5.2	Defines	1641
7.2.13.6	Example	1644
7.2.14	IMAGE: Image widget	1645
7.2.14.1	Configuration options	1645
7.2.14.2	Predefined IDs	1645
7.2.14.3	Notification codes	1645
7.2.14.4	IMAGE API	1646
7.2.14.4.1	Functions	1647
7.2.14.4.2	Defines	1663
7.2.15	KEYBOARD: Keyboard widget	1664
7.2.15.1	Configuration options	1664
7.2.15.2	Predefined IDs	1665
7.2.15.3	Keyboard reaction	1665
7.2.15.4	Predefined keyboard layouts	1665
7.2.15.5	Structure and definition of the widget	1666
7.2.15.5.1	Key lines	1666
7.2.15.5.2	Keys	1666
7.2.15.5.3	Long press characters	1667
7.2.15.6	Import and export of layouts	1668
7.2.15.7	KEYBOARD API	1669
7.2.15.7.1	Functions	1671
7.2.15.7.2	Data structures	1695
7.2.15.7.3	Defines	1704
7.2.16	LISTBOX: List box widget	1707

7.2.16.1	Configuration options .....	1707
7.2.16.2	Predefined IDs .....	1707
7.2.16.3	Notification codes .....	1707
7.2.16.4	Keyboard reaction .....	1708
7.2.16.5	LISTBOX API .....	1708
7.2.16.5.1	Functions .....	1711
7.2.16.5.2	Defines .....	1772
7.2.16.6	Examples .....	1774
7.2.17	LISTVIEW: Listview widget .....	1775
7.2.17.1	Configuration options .....	1776
7.2.17.2	Predefined IDs .....	1776
7.2.17.3	Notification codes .....	1777
7.2.17.4	Keyboard reaction .....	1777
7.2.17.5	LISTVIEW API .....	1777
7.2.17.5.1	Functions .....	1781
7.2.17.5.2	Defines .....	1870
7.2.17.6	Example .....	1871
7.2.18	MENU: Menu widget .....	1872
7.2.18.1	Menu messages .....	1873
7.2.18.1.1	WM_MENU .....	1873
7.2.18.2	Configuration options .....	1873
7.2.18.3	Keyboard reaction .....	1874
7.2.18.4	MENU API .....	1875
7.2.18.4.1	Functions .....	1877
7.2.18.4.2	Data structures .....	1913
7.2.18.4.3	Defines .....	1915
7.2.18.5	Example .....	1920
7.2.19	MOVIE: Movie widget .....	1921
7.2.19.1	Widget controls .....	1921
7.2.19.2	Configuration options .....	1922
7.2.19.3	Predefined IDs .....	1922
7.2.19.4	MOVIE API .....	1923
7.2.19.4.1	Functions .....	1925
7.2.19.4.2	Defines .....	1961
7.2.20	MULTIEDIT: Multi line text widget .....	1964
7.2.20.1	Configuration options .....	1964
7.2.20.2	Predefined IDs .....	1966
7.2.20.3	Notification codes .....	1966
7.2.20.4	Keyboard reaction .....	1966
7.2.20.5	MULTIEDIT API .....	1967
7.2.20.5.1	Functions .....	1970
7.2.20.5.2	Defines .....	2025
7.2.20.6	Example .....	2028
7.2.21	MULTIPAGE: Multiple page widget .....	2029
7.2.21.1	Configuration options .....	2031
7.2.21.2	Predefined IDs .....	2031
7.2.21.3	Notification codes .....	2032
7.2.21.4	Keyboard reaction .....	2032
7.2.21.5	MULTIPAGE API .....	2032
7.2.21.5.1	Functions .....	2035
7.2.21.5.2	Defines .....	2079
7.2.21.6	Example .....	2083
7.2.22	PROGBAR: Progress bar widget .....	2084
7.2.22.1	Configuration options .....	2084
7.2.22.2	Predefined IDs .....	2084
7.2.22.3	Notification codes .....	2084
7.2.22.4	Keyboard reaction .....	2085
7.2.22.5	PROGBAR API .....	2086
7.2.22.5.1	Functions .....	2087
7.2.22.5.2	Defines .....	2107

7.2.22.6	Examples .....	2108
7.2.23	QRCODE: QR code widget .....	2109
7.2.23.1	Configuration options .....	2109
7.2.23.2	Predefined IDs .....	2109
7.2.23.3	Keyboard reaction .....	2109
7.2.23.4	QRCODE API .....	2110
7.2.23.4.1	Functions .....	2111
7.2.23.4.2	Defines .....	2118
7.2.24	RADIO: Radio button widget .....	2119
7.2.24.1	Configuration options .....	2119
7.2.24.2	Predefined IDs .....	2120
7.2.24.3	Notification codes .....	2120
7.2.24.4	Keyboard reaction .....	2120
7.2.24.5	RADIO API .....	2121
7.2.24.5.1	Functions .....	2123
7.2.24.5.2	Defines .....	2155
7.2.24.6	Examples .....	2156
7.2.25	ROTARY: Rotary widget .....	2157
7.2.25.1	Configuration options .....	2157
7.2.25.2	Predefined IDs .....	2158
7.2.25.3	Notification codes .....	2158
7.2.25.4	Keyboard reaction .....	2158
7.2.25.5	ROTARY API .....	2159
7.2.25.5.1	ROTARY_AddAngle() .....	2160
7.2.25.5.2	ROTARY_AddValue() .....	2161
7.2.25.5.3	ROTARY_CreateEx() .....	2162
7.2.25.5.4	ROTARY_CreateIndirect() .....	2163
7.2.25.5.5	ROTARY_CreateUser() .....	2164
7.2.25.5.6	ROTARY_GetAngle() .....	2165
7.2.25.5.7	ROTARY_GetImageSize() .....	2166
7.2.25.5.8	ROTARY_GetMarkerSize() .....	2167
7.2.25.5.9	ROTARY_GetUserData() .....	2168
7.2.25.5.10	ROTARY_GetValue() .....	2169
7.2.25.5.11	ROTARY_SetAngle() .....	2170
7.2.25.5.12	ROTARY_SetBitmap() .....	2171
7.2.25.5.13	ROTARY_SetDoRotate() .....	2172
7.2.25.5.14	ROTARY_SetMarker() .....	2173
7.2.25.5.15	ROTARY_SetOffset() .....	2174
7.2.25.5.16	ROTARY_SetPeriod() .....	2175
7.2.25.5.17	ROTARY_SetRadius() .....	2176
7.2.25.5.18	ROTARY_SetRange() .....	2177
7.2.25.5.19	ROTARY_SetSnap() .....	2178
7.2.25.5.20	ROTARY_SetTickSize() .....	2179
7.2.25.5.21	ROTARY_SetUserData() .....	2180
7.2.25.5.22	ROTARY_SetValue() .....	2181
7.2.25.5.23	ROTARY_SetValueRange() .....	2182
7.2.26	SCROLLBAR: Scroll bar widget .....	2183
7.2.26.1	Configuration options .....	2183
7.2.26.2	Predefined IDs .....	2183
7.2.26.3	Notification codes .....	2185
7.2.26.4	Keyboard reaction .....	2185
7.2.26.5	SCROLLBAR API .....	2186
7.2.26.5.1	Functions .....	2187
7.2.26.5.2	Defines .....	2212
7.2.26.6	Example .....	2214
7.2.27	SCROLLER: Scroll widget .....	2215
7.2.27.1	Structure of the SCROLLER widget .....	2216
7.2.27.2	Configuration options .....	2217
7.2.27.3	Predefined IDs .....	2217
7.2.27.4	Notification codes .....	2218

7.2.27.5	Widget behavior .....	2218
7.2.27.6	Attaching SCROLLERS to widgets .....	2219
7.2.27.7	Attaching SCROLLERS to custom widgets .....	2220
7.2.27.8	SCROLLER API .....	2224
7.2.27.8.1	Functions .....	2227
7.2.27.8.2	Data structures .....	2287
7.2.27.8.3	Defines .....	2288
7.2.28	SLIDER: Slider widget .....	2293
7.2.28.1	Configuration options .....	2293
7.2.28.2	Predefined IDs .....	2293
7.2.28.3	Notification codes .....	2294
7.2.28.3.1	Keyboard reaction .....	2294
7.2.28.4	SLIDER API .....	2294
7.2.28.4.1	Functions .....	2296
7.2.28.4.2	Defines .....	2317
7.2.28.5	Example .....	2318
7.2.29	SPINBOX: Spinning box widget .....	2319
7.2.29.1	Configuration options .....	2319
7.2.29.2	Predefined IDs .....	2320
7.2.29.3	Notification codes .....	2321
7.2.29.4	Keyboard reaction .....	2321
7.2.29.5	SPINBOX API .....	2321
7.2.29.5.1	Functions .....	2323
7.2.29.5.2	Defines .....	2349
7.2.29.6	Example .....	2353
7.2.30	SWIPELIST: Swipelists widget .....	2354
7.2.30.1	Structure of the SWIPELIST widget .....	2354
7.2.30.2	Difference between separator items and items .....	2356
7.2.30.3	Configuration options .....	2356
7.2.30.4	Predefined IDs .....	2357
7.2.30.5	Notification codes .....	2358
7.2.30.6	SWIPELIST API .....	2358
7.2.30.6.1	Functions .....	2361
7.2.30.6.2	Defines .....	2431
7.2.30.7	Examples .....	2436
7.2.31	SWITCH: Switch widget .....	2437
7.2.31.1	Configuration options .....	2437
7.2.31.2	Predefined IDs .....	2437
7.2.31.3	Notification codes .....	2437
7.2.31.4	SWITCH API .....	2438
7.2.31.4.1	Functions .....	2440
7.2.31.4.2	Defines .....	2462
7.2.32	TEXT: Text widget .....	2467
7.2.32.1	Configuration options .....	2467
7.2.32.2	Predefined IDs .....	2467
7.2.32.3	Notification codes .....	2468
7.2.32.4	Keyboard reaction .....	2468
7.2.32.5	TEXT API .....	2468
7.2.32.5.1	Functions .....	2470
7.2.32.5.2	Defines .....	2507
7.2.32.6	Examples .....	2508
7.2.33	TICKER: Ticker widget .....	2509
7.2.33.1	Configuration options .....	2509
7.2.33.2	Predefined IDs .....	2509
7.2.33.3	Notification codes .....	2510
7.2.33.4	Keyboard reaction .....	2510
7.2.33.5	TICKER API .....	2510
7.2.33.5.1	Functions .....	2512
7.2.33.5.2	Defines .....	2553
7.2.34	TREEVIEW: Treeview widget .....	2554



7.2.34.1	Description of terms .....	2555
7.2.34.2	Configuration options .....	2555
7.2.34.3	Predefined IDs .....	2556
7.2.34.4	Notification codes .....	2556
7.2.34.5	Keyboard reaction .....	2557
7.2.34.6	TREEVIEW API .....	2557
7.2.34.6.1	Common routines .....	2560
7.2.34.6.2	Item related routines .....	2594
7.2.34.6.3	Data structures .....	2607
7.2.34.6.4	Defines .....	2608
7.2.34.7	Example .....	2615
7.2.35	WHEEL: Wheel widget .....	2616
7.2.35.1	Structure of the WHEEL widget .....	2616
7.2.35.2	Configuration options .....	2618
7.2.35.3	Predefined IDs .....	2618
7.2.35.4	Notification codes .....	2618
7.2.35.5	WHEEL API .....	2618
7.2.35.5.1	Functions .....	2621
7.2.35.5.2	Defines .....	2667
7.2.36	WINDOW: Window widget .....	2670
7.2.36.1	Configuration options .....	2670
7.2.36.2	Keyboard reaction .....	2670
7.2.36.3	WINDOW API .....	2670
7.2.36.3.1	WINDOW_CreateEx() .....	2671
7.2.36.3.2	WINDOW_CreateIndirect() .....	2672
7.2.36.3.3	WINDOW_CreateUser() .....	2673
7.2.36.3.4	WINDOW_GetUserData() .....	2674
7.2.36.3.5	WINDOW_SetBkColor() .....	2675
7.2.36.3.6	WINDOW_SetDefaultBkColor() .....	2676
7.2.36.3.7	WINDOW_SetUserData() .....	2677
7.2.37	Obsolete widgets .....	2678
7.2.37.1	KNOB: Knob widget (obsolete) .....	2678
7.2.37.1.1	Requirements .....	2678
7.2.37.1.2	Configuration options .....	2679
7.2.37.1.3	Predefined IDs .....	2679
7.2.37.1.4	Notification codes .....	2679
7.2.37.1.5	Keyboard reaction .....	2679
7.2.37.1.6	KNOB API .....	2680
7.2.37.2	LISTWHEEL: Listwheel widget (obsolete) .....	2700
7.2.37.2.1	Configuration options .....	2700
7.2.37.2.2	Predefined IDs .....	2701
7.2.37.2.3	Notification codes .....	2701
7.2.37.2.4	Keyboard reaction .....	2701
7.2.37.2.5	LISTWHEEL API .....	2702
7.3	Dialogs .....	2742
7.3.1	Dialog basics .....	2742
7.3.2	Creating a dialog .....	2743
7.3.2.1	Resource table .....	2743
7.3.2.2	Dialog procedure .....	2743
7.3.2.2.1	Initializing the dialog .....	2744
7.3.2.3	Defining dialog behavior .....	2745
7.3.3	Dialog API .....	2746
7.3.3.1	GUI_CreateDialogBox() .....	2747
7.3.3.2	GUI_ExecCreatedDialog() .....	2748
7.3.3.3	GUI_ExecDialogBox() .....	2749
7.3.3.4	GUI_EndDialog() .....	2750
7.3.4	CALENDAR dialog .....	2751
7.3.4.1	Notification codes .....	2751
7.3.4.2	Keyboard reaction .....	2751
7.3.4.3	CALENDAR_API .....	2752

7.3.4.3.1	Functions .....	2753
7.3.4.3.2	Data structures .....	2768
7.3.4.3.3	Defines .....	2769
7.3.5	CHOOSECOLOR dialog .....	2772
7.3.5.1	Notification codes .....	2772
7.3.5.2	Keyboard reaction .....	2772
7.3.5.3	CHOOSECOLOR API .....	2773
7.3.5.3.1	Functions .....	2774
7.3.5.3.2	Defines .....	2781
7.3.6	CHOOSEFILE dialog .....	2782
7.3.6.1	Configuring options .....	2782
7.3.6.2	Keyboard reaction .....	2782
7.3.6.3	Path- and file names .....	2782
7.3.6.4	CHOOSEFILE API .....	2783
7.3.6.4.1	Functions .....	2784
7.3.6.4.2	Data structures .....	2791
7.3.6.4.3	Defines .....	2793
7.3.6.4.4	Prototypes .....	2794
7.3.7	MESSAGEBOX dialog .....	2797
7.3.7.1	Configuration options .....	2797
7.3.7.2	Keyboard reaction .....	2797
7.3.7.3	MESSAGEBOX API .....	2797
7.3.7.3.1	GUI_MessageBox() .....	2798
7.3.7.3.2	MESSAGEBOX_Create() .....	2799
7.4	Skinning .....	2800
7.4.1	What is a 'skin' .....	2800
7.4.2	From using API functions to skinning .....	2800
7.4.3	Skinnable widgets .....	2802
7.4.4	Using a skin .....	2802
7.4.4.1	Runtime configuration .....	2803
7.4.4.2	Compile-time configuration .....	2803
7.4.5	Simple changes to the look of the 'Flex' skin .....	2803
7.4.6	Major changes to the 'Flex' skin .....	2804
7.4.6.1	The skinning callback mechanism .....	2804
7.4.6.2	Changing the look of the default skin .....	2804
7.4.6.3	List of commands .....	2806
7.4.7	General Skinning API .....	2807
7.4.7.1	<WIDGET>_DrawSkinFlex() .....	2808
7.4.7.2	<WIDGET>_GetSkinFlexProps() .....	2809
7.4.7.3	<WIDGET>_SetDefaultSkin() .....	2810
7.4.7.4	<WIDGET>_SetDefaultSkinClassic() .....	2811
7.4.7.5	<WIDGET>_SetSkin() .....	2812
7.4.7.6	<WIDGET>_SetSkinClassic() .....	2813
7.4.7.7	<WIDGET>_SetSkinFlexProps() .....	2814
7.4.8	BUTTON_SKIN_FLEX .....	2815
7.4.8.1	Configuration structure .....	2815
7.4.8.2	Configuration options .....	2816
7.4.8.3	Skinning API .....	2816
7.4.8.3.1	BUTTON_SetSkinFlexProps() .....	2817
7.4.8.4	List of commands .....	2818
7.4.8.4.1	WIDGET_ITEM_CREATE .....	2818
7.4.8.4.2	WIDGET_ITEM_DRAW_BACKGROUND .....	2818
7.4.8.4.3	WIDGET_ITEM_DRAW_BITMAP .....	2818
7.4.8.4.4	WIDGET_ITEM_DRAW_TEXT .....	2819
7.4.9	CHECKBOX_SKIN_FLEX .....	2820
7.4.9.1	Configuration structure .....	2820
7.4.9.2	Configuration options .....	2821
7.4.9.3	Skinning API .....	2821
7.4.9.3.1	CHECKBOX_GetSkinFlexButtonSize() .....	2822
7.4.9.3.2	CHECKBOX_SetSkinFlexButtonSize() .....	2823

7.4.9.3.3	CHECKBOX_SetSkinFlexProps()	2824
7.4.9.4	List of commands	2825
7.4.9.4.1	WIDGET_ITEM_CREATE	2825
7.4.9.4.2	WIDGET_ITEM_DRAW_BUTTON	2825
7.4.9.4.3	WIDGET_ITEM_DRAW_BITMAP	2825
7.4.9.4.4	WIDGET_ITEM_DRAW_FOCUS	2826
7.4.9.4.5	WIDGET_ITEM_DRAW_TEXT	2826
7.4.10	DROPDOWN_SKIN_FLEX	2827
7.4.10.1	Configuration structure	2827
7.4.10.2	Configuration options	2828
7.4.10.3	Skinning API	2828
7.4.10.3.1	DROPDOWN_SetSkinFlexProps()	2829
7.4.10.4	List of commands	2830
7.4.10.4.1	WIDGET_ITEM_CREATE	2830
7.4.10.4.2	WIDGET_ITEM_DRAW_ARROW	2830
7.4.10.4.3	WIDGET_ITEM_DRAW_BACKGROUND	2830
7.4.10.4.4	WIDGET_ITEM_DRAW_TEXT	2830
7.4.11	FRAMEWIN_SKIN_FLEX	2831
7.4.11.1	Configuration structure	2831
7.4.11.2	Configuration options	2832
7.4.11.3	Skinning API	2832
7.4.11.3.1	FRAMEWIN_SetSkinFlexProps()	2833
7.4.11.4	List of commands	2834
7.4.11.4.1	WIDGET_ITEM_CREATE	2834
7.4.11.4.2	WIDGET_ITEM_DRAW_BACKGROUND	2834
7.4.11.4.3	WIDGET_ITEM_DRAW_FRAME	2835
7.4.11.4.4	WIDGET_ITEM_DRAW_TEXT	2835
7.4.11.4.5	WIDGET_ITEM_GET_BORDERSIZE_L	2835
7.4.11.4.6	WIDGET_ITEM_GET_BORDERSIZE_R	2835
7.4.11.4.7	WIDGET_ITEM_GET_BORDERSIZE_T	2835
7.4.11.4.8	WIDGET_ITEM_GET_BORDERSIZE_B	2835
7.4.12	HEADER_SKIN_FLEX	2836
7.4.12.1	Configuration structure	2836
7.4.12.2	Configuration options	2836
7.4.12.3	Skinning API	2837
7.4.12.3.1	HEADER_SetSkinFlexProps()	2838
7.4.12.4	List of commands	2839
7.4.12.4.1	WIDGET_ITEM_CREATE	2839
7.4.12.4.2	WIDGET_ITEM_DRAW_ARROW	2839
7.4.12.4.3	WIDGET_ITEM_DRAW_BACKGROUND	2839
7.4.12.4.4	WIDGET_ITEM_DRAW_BITMAP	2839
7.4.12.4.5	WIDGET_ITEM_DRAW_OVERLAP	2840
7.4.12.4.6	Widget_ITEM_DRAW_TEXT	2840
7.4.13	MENU_SKIN_FLEX	2841
7.4.13.1	Configuration structure	2842
7.4.13.2	Configuration options	2843
7.4.13.3	Skinning API	2843
7.4.13.3.1	MENU_SetSkinFlexProps()	2844
7.4.13.3.2	MENU_SkinEnableArrow()	2845
7.4.13.4	List of commands	2846
7.4.13.4.1	WIDGET_ITEM_CREATE	2846
7.4.13.4.2	WIDGET_ITEM_DRAW_ARROW	2846
7.4.13.4.3	WIDGET_ITEM_DRAW_BACKGROUND	2847
7.4.13.4.4	WIDGET_ITEM_DRAW_FRAME	2847
7.4.13.4.5	WIDGET_ITEM_DRAW_TEXT	2847
7.4.14	MULTIPAGE_SKIN_FLEX	2848
7.4.14.1	Configuration structure	2848
7.4.14.2	Configuration options	2849
7.4.14.3	Skinning API	2849
7.4.14.3.1	MULTIPAGE_SetSkinFlexProps()	2850

7.4.14.4	List of commands .....	2851
7.4.14.4.1	WIDGET_ITEM_CREATE .....	2852
7.4.14.4.2	WIDGET_ITEM_DRAW_BACKGROUND .....	2852
7.4.14.4.3	WIDGET_ITEM_DRAW_FRAME .....	2852
7.4.14.4.4	WIDGET_ITEM_DRAW_TEXT .....	2852
7.4.15	PROGBAR_SKIN_FLEX .....	2853
7.4.15.1	Configuration structure .....	2853
7.4.15.2	Configuration options .....	2854
7.4.15.3	Skinning API .....	2854
7.4.15.3.1	PROGBAR_SetSkinFlexProps() .....	2855
7.4.15.4	List of commands .....	2856
7.4.15.4.1	WIDGET_ITEM_CREATE .....	2856
7.4.15.4.2	WIDGET_ITEM_DRAW_BACKGROUND .....	2856
7.4.15.4.3	WIDGET_ITEM_DRAW_FRAME .....	2857
7.4.15.4.4	WIDGET_ITEM_DRAW_TEXT .....	2857
7.4.16	RADIO_SKIN_FLEX .....	2858
7.4.16.1	Configuration structure .....	2858
7.4.16.2	Configuration options .....	2859
7.4.16.3	Skinning API .....	2859
7.4.16.3.1	RADIO_SetSkinFlexProps() .....	2860
7.4.16.4	List of commands .....	2861
7.4.16.4.1	WIDGET_ITEM_DRAW_FOCUS .....	2862
7.4.16.4.2	WIDGET_ITEM_DRAW_TEXT .....	2862
7.4.16.4.3	WIDGET_ITEM_GET_BUTTONSIZE .....	2862
7.4.17	SCROLLBAR_SKIN_FLEX .....	2863
7.4.17.1	Configuration structure .....	2863
7.4.17.2	Configuration options .....	2864
7.4.17.3	Skinning API .....	2864
7.4.17.3.1	SCROLLBAR_SetSkinFlexProps() .....	2865
7.4.17.4	List of commands .....	2866
7.4.17.4.1	WIDGET_ITEM_DRAW_BUTTON_L .....	2866
7.4.17.4.2	WIDGET_ITEM_DRAW_BUTTON_R .....	2866
7.4.17.4.3	WIDGET_ITEM_DRAW_OVERLAP .....	2867
7.4.17.4.4	WIDGET_ITEM_DRAW_SHAFT_L .....	2867
7.4.17.4.5	WIDGET_ITEM_DRAW_SHAFT_R .....	2867
7.4.17.4.6	WIDGET_ITEM_DRAW_THUMB .....	2868
7.4.17.4.7	WIDGET_ITEM_GET_BUTTONSIZE .....	2868
7.4.18	SLIDER_SKIN_FLEX .....	2869
7.4.18.1	Configuration structure .....	2869
7.4.18.2	Configuration options .....	2870
7.4.18.3	Skinning API .....	2870
7.4.18.3.1	SLIDER_SetSkinFlexProps() .....	2871
7.4.18.4	List of commands .....	2872
7.4.18.4.1	WIDGET_ITEM_CREATE .....	2872
7.4.18.4.2	WIDGET_ITEM_DRAW_FOCUS .....	2872
7.4.18.4.3	WIDGET_ITEM_DRAW_SHAFT .....	2872
7.4.18.4.4	WIDGET_ITEM_DRAW_THUMB .....	2873
7.4.18.4.5	WIDGET_ITEM_DRAW_TICKS .....	2873
7.4.19	SPINBOX_SKIN_FLEX .....	2874
7.4.19.1	Configuration options .....	2875
7.4.19.2	Skinning API .....	2875
7.4.19.2.1	SPINBOX_SetSkinFlexProps() .....	2876
7.4.19.3	List of commands .....	2877
7.4.19.3.1	WIDGET_ITEM_CREATE .....	2877
7.4.19.3.2	WIDGET_ITEM_DRAW_BACKGROUND .....	2877
7.4.19.3.3	WIDGET_ITEM_DRAW_BUTTON_U .....	2877
7.4.19.3.4	WIDGET_ITEM_DRAW_BUTTON_D .....	2878
7.5	Anti-aliasing .....	2879
7.5.1	Introduction .....	2879
7.5.2	Quality of anti-aliasing .....	2879

7.5.3	Anti-aliased fonts .....	2880
7.5.3.1	Character representation in font files .....	2880
7.5.3.2	Gamma correction .....	2880
7.5.4	High-resolution coordinates .....	2881
7.5.5	Anti-aliasing API .....	2883
7.5.5.1	Control functions .....	2885
7.5.5.1.1	GUI_AA_DisableHiRes() .....	2885
7.5.5.1.2	GUI_AA_EnableHiRes() .....	2886
7.5.5.1.3	GUI_AA_GetFactor() .....	2887
7.5.5.1.4	GUI_AA_PreserveTrans() .....	2888
7.5.5.1.5	GUI_AA_SetBufferSize() .....	2889
7.5.5.1.6	GUI_AA_SetFactor() .....	2890
7.5.5.2	Drawing functions .....	2891
7.5.5.2.1	GUI_AA_DrawArc() .....	2891
7.5.5.2.2	GUI_AA_DrawCircle() .....	2892
7.5.5.2.3	GUI_AA_DrawLine() .....	2893
7.5.5.2.4	GUI_AA_DrawPie() .....	2894
7.5.5.2.5	GUI_AA_DrawPolyOutline() .....	2895
7.5.5.2.6	GUI_AA_DrawRoundedFrame() .....	2896
7.5.5.2.7	GUI_AA_DrawRoundedFrameEx() .....	2897
7.5.5.2.8	GUI_AA_DrawRoundedRect() .....	2898
7.5.5.2.9	GUI_AA_DrawRoundedRectEx() .....	2899
7.5.5.2.10	GUI_AA_FillCircle() .....	2900
7.5.5.2.11	GUI_AA_FillEllipse() .....	2901
7.5.5.2.12	GUI_AA_FillEllipseXL() .....	2902
7.5.5.2.13	GUI_AA_FillPolygon() .....	2903
7.5.5.2.14	GUI_AA_FillRoundedRect() .....	2904
7.5.5.2.15	GUI_AA_FillRoundedRectEx() .....	2905
7.5.5.2.16	GUI_AA_SetDrawMode() .....	2906
7.5.5.3	Gamma correction .....	2907
7.5.5.3.1	GUI_AA_EnableGammaAA4() .....	2907
7.5.5.3.2	GUI_AA_GetGammaAA4() .....	2908
7.5.5.3.3	GUI_AA_SetGammaAA4() .....	2909
7.5.6	Examples .....	2910
7.5.6.1	Different anti-aliasing factors .....	2910
7.5.6.2	Lines placed on high-resolution coordinates .....	2912
7.5.6.3	Moving pointer using high-resolution anti-aliasing .....	2914
7.6	Memory Devices .....	2916
7.6.1	Using Memory Devices: Illustration .....	2917
7.6.2	Supported color depth (bpp) .....	2918
7.6.3	Memory Devices and the Window Manager .....	2918
7.6.4	Memory Devices and multiple layers .....	2919
7.6.5	Memory requirements .....	2920
7.6.6	Performance .....	2921
7.6.7	Performance gain with Static Memory Devices .....	2921
7.6.7.1	Memory requirement .....	2921
7.6.7.2	Example .....	2921
7.6.8	Basic functions .....	2921
7.6.9	In order to be able to use Memory Devices... ..	2922
7.6.10	MultiLayer / MultiDisplay configuration .....	2922
7.6.11	Configuration options .....	2922
7.6.12	Memory Device API .....	2922
7.6.12.1	Basic functions .....	2927
7.6.12.1.1	GUI_MEMDEV_Clear() .....	2927
7.6.12.1.2	GUI_MEMDEV_ClearAlpha() .....	2928
7.6.12.1.3	GUI_MEMDEV_CopyFromLCD() .....	2930
7.6.12.1.4	GUI_MEMDEV_CopyRect() .....	2931
7.6.12.1.5	GUI_MEMDEV_CopyToLCD() .....	2932
7.6.12.1.6	GUI_MEMDEV_CopyToLCDAA() .....	2933
7.6.12.1.7	GUI_MEMDEV_CopyToLCDAt() .....	2934

7.6.12.1.8	GUI_MEMDEV_Create()	2935
7.6.12.1.9	GUI_MEMDEV_CreateCopy()	2936
7.6.12.1.10	GUI_MEMDEV_CreateEx()	2937
7.6.12.1.11	GUI_MEMDEV_CreateFixed()	2938
7.6.12.1.12	GUI_MEMDEV_CreateFixed32()	2939
7.6.12.1.13	GUI_MEMDEV_Delete()	2940
7.6.12.1.14	GUI_MEMDEV_DrawPerspectiveX()	2941
7.6.12.1.15	GUI_MEMDEV_GetBitsPerPixel()	2943
7.6.12.1.16	GUI_MEMDEV_GetDataPtr()	2944
7.6.12.1.17	GUI_MEMDEV_GetSelMemdev()	2945
7.6.12.1.18	GUI_MEMDEV_GetXSize()	2946
7.6.12.1.19	GUI_MEMDEV_GetYSize()	2947
7.6.12.1.20	GUI_MEMDEV_MarkDirty()	2948
7.6.12.1.21	GUI_MEMDEV_PunchOutDevice()	2949
7.6.12.1.22	GUI_MEMDEV_ReduceYSize()	2951
7.6.12.1.23	GUI_MEMDEV_Rotate()	2952
7.6.12.1.24	GUI_MEMDEV_RotateAlpha()	2952
7.6.12.1.25	GUI_MEMDEV_RotateHQ()	2952
7.6.12.1.26	GUI_MEMDEV_RotateHQAlpha()	2952
7.6.12.1.27	GUI_MEMDEV_RotateHQHR()	2952
7.6.12.1.28	GUI_MEMDEV_RotateHQT()	2952
7.6.12.1.29	GUI_MEMDEV_RotateHR()	2952
7.6.12.1.30	GUI_MEMDEV_Select()	2956
7.6.12.1.31	GUI_MEMDEV_SerializeBMP()	2957
7.6.12.1.32	GUI_MEMDEV_SerializeExBMP()	2958
7.6.12.1.33	GUI_MEMDEV_SetOrg()	2959
7.6.12.1.34	GUI_MEMDEV_Write()	2960
7.6.12.1.35	GUI_MEMDEV_WriteAlpha()	2961
7.6.12.1.36	GUI_MEMDEV_WriteAlphaAt()	2962
7.6.12.1.37	GUI_MEMDEV_WriteAt()	2963
7.6.12.1.38	GUI_MEMDEV_WriteEx()	2964
7.6.12.1.39	GUI_MEMDEV_WriteExAt()	2965
7.6.12.1.40	GUI_MEMDEV_WriteOpaque()	2966
7.6.12.1.41	GUI_MEMDEV_WriteOpaqueAt()	2967
7.6.12.1.42	GUI_SelectLCD()	2968
7.6.12.2	Example for using a Memory Device	2969
7.6.12.3	Banding Memory Device	2970
7.6.12.3.1	GUI_MEMDEV_Draw()	2970
7.6.12.3.2	Example for using a banding Memory Device	2971
7.6.12.4	Auto device object functions	2972
7.6.12.4.1	GUI_MEMDEV_CreateAuto()	2972
7.6.12.4.2	GUI_MEMDEV_DeleteAuto()	2973
7.6.12.4.3	GUI_MEMDEV_DrawAuto()	2974
7.6.12.4.4	Example for using an auto device object	2975
7.6.12.5	Measurement device object functions	2976
7.6.12.5.1	GUI_MEASDEV_ClearRect()	2976
7.6.12.5.2	GUI_MEASDEV_Create()	2977
7.6.12.5.3	GUI_MEASDEV_Delete()	2978
7.6.12.5.4	GUI_MEASDEV_GetRect()	2979
7.6.12.5.5	GUI_MEASDEV_Select()	2980
7.6.12.6	Animation functions	2981
7.6.12.6.1	GUI_MEMDEV_FadeInDevices()	2981
7.6.12.6.2	GUI_MEMDEV_FadeOutDevices()	2982
7.6.12.6.3	GUI_MEMDEV_SetAnimationCallback()	2983
7.6.12.6.4	GUI_MEMDEV_SetTimePerFrame()	2984
7.6.12.7	Animation functions (Window Manager required)	2985
7.6.12.7.1	GUI_MEMDEV_FadeInWindow()	2985
7.6.12.7.2	GUI_MEMDEV_FadeOutWindow()	2985
7.6.12.7.3	GUI_MEMDEV_MoveInWindow()	2986
7.6.12.7.4	GUI_MEMDEV_MoveOutWindow()	2986

7.6.12.7.5	GUI_MEMDEV_ShiftInWindow()	2988
7.6.12.7.6	GUI_MEMDEV_ShiftOutWindow()	2988
7.6.12.7.7	GUI_MEMDEV_SwapWindow()	2989
7.6.12.8	Blending, Blurring and Dithering functions	2990
7.6.12.8.1	GUI_MEMDEV_BlendColor32()	2990
7.6.12.8.2	GUI_MEMDEV_CreateBlurredDevice32()	2991
7.6.12.8.3	GUI_MEMDEV_CreateBlurredDevice32HQ()	2993
7.6.12.8.4	GUI_MEMDEV_CreateBlurredDevice32LQ()	2994
7.6.12.8.5	GUI_MEMDEV_Dither32()	2995
7.6.12.8.6	GUI_MEMDEV_SetBlurHQ()	2996
7.6.12.8.7	GUI_MEMDEV_SetBlurLQ()	2997
7.6.12.9	Blending and Blurring functions (Window Manager required)	2998
7.6.12.9.1	GUI_MEMDEV_BlendWinBk()	2998
7.6.12.9.2	GUI_MEMDEV_BlurAndBlendWinBk()	2999
7.6.12.9.3	GUI_MEMDEV_BlurWinBk()	3000
7.6.12.10	Setting up multiple buffering for animation functions	3001
7.6.12.10.1	GUI_MEMDEV_MULTIBUF_Enable()	3001
7.6.12.11	Memory bitmaps	3002
7.6.12.11.1	Predefined drawing functions	3003
7.6.12.11.2	User defined drawing function	3004
7.6.12.11.3	GUI_MBITMAP_PARAM	3006
7.6.12.11.4	GUI_MBITMAP_CONFIG	3007
7.6.12.11.5	GUI_MBITMAP_Create()	3008
7.6.12.11.6	GUI_MBITMAP_CreateEx()	3009
7.6.12.11.7	GUI_MBITMAP_CreateUser()	3010
7.6.12.11.8	GUI_MBITMAP_CreateUserEx()	3011
7.6.12.11.9	GUI_MBITMAP_Delete()	3012
7.6.12.11.10	GUI_MBITMAP_SetColorFormat()	3013
7.6.12.12	Defines	3014
7.6.12.12.1	Color conversion routines	3014
7.6.12.12.2	Direction symbols	3015
7.6.12.12.3	Memory device color depths	3016
7.6.12.12.4	Memory device flags	3017
7.7	MultiTouch support (MT)	3018
7.7.1	Introduction	3018
7.7.2	Getting started	3019
7.7.3	Using basic buffer access	3020
7.7.4	Using gestures	3022
7.7.5	Window animation	3023
7.7.6	Basic buffer access API	3024
7.7.6.1	Functions	3025
7.7.6.1.1	GUI_MTOUCH_Enable()	3025
7.7.6.1.2	GUI_MTOUCH_GetEvent()	3026
7.7.6.1.3	GUI_MTOUCH_GetTouchInput()	3027
7.7.6.1.4	GUI_MTOUCH_IsEmpty()	3028
7.7.6.1.5	GUI_MTOUCH_SetOrientation()	3029
7.7.6.1.6	GUI_MTOUCH_StoreEvent()	3030
7.7.6.2	Data structures	3031
7.7.6.2.1	GUI_MTOUCH_EVENT	3031
7.7.6.2.2	GUI_MTOUCH_INPUT	3032
7.7.6.2.3	WM_GESTURE_INFO	3033
7.7.6.2.4	WM_ZOOM_INFO	3034
7.7.6.3	Defines	3035
7.7.6.3.1	MultiTouch flags	3035
7.7.6.3.2	MultiTouch gesture flags	3036
7.8	VNC Server	3037
7.8.1	Introduction	3038
7.8.1.1	Filetransfer	3038
7.8.1.2	Requirements	3038
7.8.1.3	Notes on this implementation	3038

7.8.2	emVNC client .....	3040
7.8.2.1	How to connect to a VNC-server .....	3040
7.8.2.2	Opening the file transfer dialog .....	3040
7.8.2.3	The file transfer window .....	3041
7.8.2.4	Connecting with a web browser .....	3042
7.8.3	emWin VNC server .....	3043
7.8.3.1	Starting the emWin VNC server .....	3043
7.8.3.2	Enabling file transfer support .....	3043
7.8.3.3	Starting the VNC server in the simulation .....	3043
7.8.3.4	Example of starting the VNC server on the target system .....	3043
7.8.4	RAM and ROM requirements .....	3043
7.8.5	VNC Server API .....	3044
7.8.5.1	Functions .....	3045
7.8.5.1.1	GUI_VNC_AttachToLayer() .....	3045
7.8.5.1.2	GUI_VNC_EnableFileTransfer() .....	3046
7.8.5.1.3	GUI_VNC_EnableKeyboardInput() .....	3047
7.8.5.1.4	GUI_VNC_GetNumConnections() .....	3048
7.8.5.1.5	GUI_VNC_Process() .....	3049
7.8.5.1.6	GUI_VNC_RingBell() .....	3050
7.8.5.1.7	GUI_VNC_SetFS_API() .....	3051
7.8.5.1.8	GUI_VNC_SetLockFrame() .....	3052
7.8.5.1.9	GUI_VNC_SetPassword() .....	3053
7.8.5.1.10	GUI_VNC_SetProgName() .....	3054
7.8.5.1.11	GUI_VNC_SetRetryCount() .....	3055
7.8.5.1.12	GUI_VNC_SetSize() .....	3056
7.8.5.1.13	GUI_VNC_X_StartServer() .....	3057
7.8.5.1.14	GUI_VNC_X_StartServerFT() .....	3058
7.8.5.2	Data structures .....	3059
7.8.5.2.1	IP_FS_API .....	3059
8	Legacy features .....	3061
8.1	Sprites .....	3062
8.1.1	Introduction .....	3062
8.1.2	Sprite API .....	3063
8.1.2.1	GUI_SPRITE_Create() .....	3064
8.1.2.2	GUI_SPRITE_CreateAnim() .....	3065
8.1.2.3	GUI_SPRITE_CreateEx() .....	3066
8.1.2.4	GUI_SPRITE_CreateExAnim() .....	3067
8.1.2.5	GUI_SPRITE_CreateHidden() .....	3068
8.1.2.6	GUI_SPRITE_CreateHiddenEx() .....	3069
8.1.2.7	GUI_SPRITE_Delete() .....	3070
8.1.2.8	GUI_SPRITE_GetState() .....	3071
8.1.2.9	GUI_SPRITE_Hide() .....	3072
8.1.2.10	GUI_SPRITE_SetBitmap() .....	3073
8.1.2.11	GUI_SPRITE_SetBitmapAndPosition() .....	3074
8.1.2.12	GUI_SPRITE_SetLoop() .....	3075
8.1.2.13	GUI_SPRITE_SetPosition() .....	3076
8.1.2.14	GUI_SPRITE_Show() .....	3077
8.1.2.15	GUI_SPRITE_StartAnim() .....	3078
8.1.2.16	GUI_SPRITE_StopAnim() .....	3079
8.2	Cursors .....	3080
8.2.1	Available cursors .....	3080
8.2.2	Cursor API .....	3081
8.2.2.1	Functions .....	3082
8.2.2.1.1	GUI_CURSOR_GetState() .....	3082
8.2.2.1.2	GUI_CURSOR_Hide() .....	3083
8.2.2.1.3	GUI_CURSOR_Select() .....	3084
8.2.2.1.4	GUI_CURSOR_SelectAnim() .....	3085
8.2.2.1.5	GUI_CURSOR_SetPosition() .....	3086



8.2.2.1.6	GUI_CURSOR_Show()	3087
8.2.2.2	Data structures	3088
8.2.2.2.1	GUI_CURSOR_ANIM	3088
8.3	Virtual screens / Virtual pages	3089
8.3.1	Introduction	3089
8.3.2	Requirements	3090
8.3.3	Configuration	3090
8.3.3.1	LCD_SetVSizeEx()	3091
8.3.4	Examples	3092
8.3.4.1	Basic example	3092
8.3.4.2	Real time example using the Window Manager	3093
8.3.4.3	Dialog example using the Window Manager	3094
8.3.4.4	Virtual screen API	3095
8.3.4.4.1	GUI_GetOrg()	3096
8.3.4.4.2	GUI_SetOrg()	3097
9	Tools	3098
9.1	AppWizard	3099
9.1.1	About the AppWizard	3100
9.2	emWinView	3101
9.2.1	Installation	3102
9.2.2	Using the simulation and the viewer	3103
9.2.3	Virtual pages	3104
9.2.4	Multibuffering	3104
9.2.5	Multiple displays	3106
9.2.5.1	Multiple layers	3106
9.2.6	Palette-based layers	3108
9.2.7	Tools	3109
9.2.7.1	Selection Tool	3109
9.2.7.2	Hand Tool	3109
9.2.7.3	Zooming	3110
9.2.7.4	Grid	3110
9.2.8	Options	3111
9.2.8.1	Always on top	3111
9.2.8.2	Highlight palette colors	3111
9.2.9	Copy to clipboard	3111
9.2.10	Closing and opening layers	3111
9.3	Bitmap Converter	3112
9.3.1	What it does	3112
9.3.2	Loading a bitmap	3113
9.3.2.1	Supported input file formats	3113
9.3.2.2	Loading from a file	3113
9.3.2.3	Using the clipboard	3114
9.3.3	Color conversion	3114
9.3.4	Dithering	3115
9.3.5	Using a custom palette	3115
9.3.5.1	Saving a palette file	3116
9.3.5.2	Palette file format	3116
9.3.5.3	Palette files for fixed palette modes	3116
9.3.5.4	Converting a bitmap	3116
9.3.6	Generating C files from bitmaps	3116
9.3.6.1	Supported bitmap formats	3117
9.3.6.2	Palette information	3118
9.3.6.3	Transparency	3118
9.3.6.4	Alpha blending	3118
9.3.6.5	Selecting the best format	3119
9.3.6.6	Saving the file	3120
9.3.7	Generating C stream files	3122
9.3.8	Compressed bitmaps	3124

9.3.9	Creating animated sprites / cursors .....	3125
9.3.9.1	Animated Sprite example .....	3125
9.3.9.2	Animated Cursor example .....	3127
9.3.9.3	Additional information .....	3127
9.3.10	Converting GIFs into Bitmap-EMFs .....	3128
9.3.11	Memory footprint .....	3130
9.3.12	Command line usage .....	3130
9.3.12.1	Format for commands .....	3130
9.3.12.2	Command line options .....	3130
9.3.13	Options .....	3132
9.3.14	Example of a converted bitmap .....	3133
9.4	Font Converter .....	3136
9.4.1	Supported file formats .....	3137
9.4.2	Architecture .....	3137
9.4.3	Creating an emWin font file from a font on the computer .....	3138
9.4.4	Font Generation Options dialog .....	3141
9.4.4.1	Type of font to generate .....	3141
9.4.4.2	Encoding .....	3142
9.4.5	Font Dialog .....	3143
9.4.5.1	Font, font style and size .....	3143
9.4.5.2	Unit of Size .....	3143
9.4.5.3	Effects .....	3143
9.4.5.4	Sample .....	3144
9.4.6	User Interface .....	3144
9.4.6.1	Selecting the current character .....	3144
9.4.6.2	Toggling character status .....	3144
9.4.6.3	Selecting pixels .....	3145
9.4.6.4	Modifying character bits .....	3145
9.4.6.5	Character and font manipulation .....	3146
9.4.6.6	Modifying the viewing mode .....	3149
9.4.7	Batch Editing of character metrics .....	3149
9.4.8	Preferences .....	3149
9.4.8.1	General .....	3149
9.4.8.2	Fonts .....	3150
9.4.8.3	User Interface .....	3150
9.4.9	Saving a font file .....	3152
9.4.10	Loading and modifying existing emWin fonts .....	3152
9.4.11	Merging fonts with other font files .....	3152
9.4.12	Pattern files .....	3153
9.4.12.1	Creating pattern files using Notepad .....	3153
9.4.12.2	Creating pattern files using the Font Converter .....	3153
9.4.12.3	Enabling characters using a pattern file .....	3153
9.4.13	Kerning files .....	3154
9.4.13.1	Saving a kerning file .....	3154
9.4.13.2	Using the kerning table .....	3154
9.4.14	Command line usage .....	3155
9.4.14.1	Summarized syntax .....	3155
9.4.14.2	Table of commands .....	3156
9.4.14.3	Loading a font file from command line .....	3157
9.4.14.4	Execution examples .....	3158
9.4.15	Differences to old Font Converter versions .....	3158
9.4.16	Font Examples .....	3159
9.4.16.1	Resulting C code, standard mode .....	3159
9.4.16.2	Resulting C code, 4 bpp anti-aliased mode .....	3160
9.5	emWinSPY .....	3162
9.5.1	Introduction .....	3162
9.5.1.1	Requirements .....	3162
9.5.1.2	Availability .....	3163
9.5.2	Starting the emWinSPY server.. ..	3163
9.5.2.1	...in the simulation environment .....	3163

9.5.2.2	...on the target hardware .....	3163
9.5.2.3	GUI_SPY_X_StartServer .....	3163
9.5.3	The emWinSPY viewer .....	3163
9.5.3.1	The screen .....	3163
9.5.3.1.1	Status area .....	3164
9.5.3.1.2	History area .....	3164
9.5.3.1.3	Windows area .....	3165
9.5.3.1.4	Input area .....	3166
9.5.3.2	Connecting to target .....	3166
9.5.3.3	Configuration options .....	3167
9.5.3.4	Taking a screenshot from the target .....	3168
9.5.4	emWinSPY API .....	3168
9.5.4.1	GUI_SPY_Process() .....	3169
9.5.4.2	GUI_SPY_SetMemHandler() .....	3170
9.5.4.3	GUI_SPY_StartServer() .....	3171
9.5.4.4	GUI_SPY_StartServerEx() .....	3172
9.5.4.5	GUI_SPY_X_StartServer() .....	3173
9.6	emWin4Web .....	3174
9.6.1	Installation .....	3175
9.6.1.1	Prerequisites .....	3175
9.6.1.1.1	Installing the Prerequisites on Windows .....	3176
9.6.1.2	Installing emWin4Web .....	3177
9.6.1.3	Configuring emWin4Web .....	3178
9.6.2	Compiling an application .....	3179
9.6.3	Running an application .....	3179
9.6.4	Command line options .....	3181
9.6.5	Global settings .....	3183
9.6.6	Customization options .....	3184
9.6.7	License information .....	3185
9.7	GUI Builder .....	3186
9.7.1	Introduction .....	3187
9.7.2	Getting started .....	3188
9.7.3	Creating a dialog .....	3188
9.7.3.1	Selecting a parent widget .....	3188
9.7.3.2	Resizing and positioning in the editor .....	3188
9.7.3.3	Modifying the widget properties .....	3189
9.7.3.4	Adding additional functions to a widget .....	3189
9.7.3.5	Deleting a widget property .....	3190
9.7.3.6	Deleting a widget .....	3190
9.7.3.7	Deleting a widget .....	3190
9.7.4	Saving the current dialog(s) .....	3191
9.7.5	Output of the GUIBuilder .....	3191
9.7.6	Modifying the C files .....	3193
9.7.7	How to use the C files .....	3193
10	Execution Model: Single Task / Multitask .....	3195
10.1	Supported execution models .....	3196
10.2	Single task system (super loop) .....	3197
10.2.1	Description .....	3197
10.2.2	Superloop example (without emWin) .....	3197
10.2.3	Advantages .....	3197
10.2.4	Disadvantages .....	3197
10.2.5	Using emWin .....	3197
10.2.6	Superloop example (with emWin) .....	3197
10.3	Multitask system: one task calling emWin .....	3199
10.3.1	Description .....	3199
10.3.2	Advantages .....	3199
10.3.3	Using emWin .....	3199
10.4	Multitask system: multiple tasks calling emWin .....	3200

10.4.1	Description .....	3200
10.4.2	Advantages .....	3200
10.4.3	Using emWin .....	3200
10.4.4	Recommendations .....	3200
10.4.5	Example .....	3200
10.5	Configuration functions for multitasking support .....	3202
10.5.1	GUI_SetSignalEventFunc() .....	3203
10.5.2	GUI_SetWaitEventFunc() .....	3204
10.5.3	GUI_SetWaitEventTimedFunc() .....	3205
10.5.4	GUI_WaitEvent() .....	3206
10.6	Configuration macros for multitasking support .....	3207
10.6.1	GUI_MAXTASK .....	3207
10.6.2	GUI_OS .....	3207
10.6.3	GUI_X_SIGNAL_EVENT .....	3207
10.6.4	GUI_X_WAIT_EVENT .....	3208
10.6.5	GUI_X_WAIT_EVENT_TIMED .....	3208
10.7	Kernel interface API .....	3209
10.7.1	GUI_X_GetTaskId() .....	3210
10.7.2	GUI_X_InitOS() .....	3211
10.7.3	GUI_X_Lock() .....	3212
10.7.4	GUI_X_SignalEvent() .....	3213
10.7.5	GUI_X_Unlock() .....	3214
10.7.6	GUI_X_WaitEvent() .....	3215
10.7.7	GUI_X_WaitEventTimed() .....	3216
10.8	Examples .....	3217
11	File Access: GetData() functions .....	3219
11.1	GetData functions .....	3220
11.2	File Access API .....	3221
11.2.1	GUI_GET_DATA_FUNC .....	3222
11.2.2	GUI_GET_DATA_FUNC_I .....	3223
11.2.3	GUI_GET_DATA_FUNC_II .....	3224
12	MultiLayer / MultiDisplay support .....	3225
12.1	Introduction .....	3226
12.1.1	Selecting a layer for drawing operations .....	3226
12.1.2	Selecting a layer for a window .....	3226
12.1.2.1	Moving a window from one layer to another .....	3227
12.2	Using MultiLayer support .....	3229
12.2.1	Transparency .....	3229
12.2.2	Alpha blending .....	3230
12.2.3	Hardware cursors .....	3231
12.2.4	MultiLayer example .....	3231
12.2.5	Configuring MultiLayer support .....	3232
12.3	Using MultiDisplay support .....	3233
12.3.1	Enabling MultiDisplay support .....	3233
12.3.2	Run-time screen rotation .....	3233
12.3.3	MultiDisplay example .....	3233
12.3.4	Configuring MultiDisplay support .....	3234
12.4	Using SoftLayers .....	3235
12.4.1	Using SoftLayers within a simulation environment .....	3235
12.4.2	Memory requirements .....	3236
12.4.3	Configuring SoftLayers .....	3236
12.5	MultiLayer API .....	3238
12.5.1	General MultiLayer functions .....	3239
12.5.1.1	GUI_AssignCursorLayer() .....	3239
12.5.1.2	GUI_GetLayerPosEx() .....	3240
12.5.1.3	GUI_SelectLayer() .....	3241
12.5.1.4	GUI_SetLayerAlphaEx() .....	3242

12.5.1.5	GUI_SetLayerPosEx()	3243
12.5.1.6	GUI_SetLayerSizeEx()	3244
12.5.1.7	GUI_SetLayerVisEx()	3245
12.5.1.8	LCD_GetNumLayers()	3246
12.5.2	SoftLayer specific functions	3247
12.5.2.1	GUI_SOFTLAYER_Enable()	3247
12.5.2.2	GUI_SOFTLAYER_Refresh()	3248
12.5.2.3	GUI_SOFTLAYER_SetCompositeColor()	3249
12.5.2.4	GUI_SOFTLAYER_MULTIBUF_Enable()	3250
12.5.3	Data structures	3251
12.5.3.1	GUI_SOFTLAYER_CONFIG	3251
<b>13</b>	<b>Display drivers</b>	<b>3252</b>
13.1	Available display drivers	3253
13.1.1	Driver file naming convention	3253
13.1.2	Run-time configurable drivers	3253
13.1.3	Compile-time configurable drivers	3254
13.2	CPU / Display controller interface	3255
13.2.1	Direct interface	3255
13.2.2	Indirect interface - Parallel bus	3255
13.2.2.1	Example routines for connection to I/O pins	3256
13.2.3	Indirect interface - 4 pin SPI	3256
13.2.3.1	Example routines for connection to I/O pins	3256
13.2.4	Indirect interface - 3 pin SPI	3256
13.2.4.1	Example routines for connection to I/O pins	3257
13.2.5	Indirect interface - I2C bus	3257
13.2.5.1	Example routines for connection to I/O pins	3257
13.3	Hardware interface configuration	3258
13.3.1	Direct interface	3258
13.3.2	Indirect interface	3258
13.3.2.1	Run-time configuration	3258
13.3.2.1.1	Elements of structure GUI_PORT_API	3258
13.3.2.2	Compile-time configuration	3261
13.3.2.2.1	LCD_READ_A0	3262
13.3.2.2.2	LCD_READ_A1	3262
13.3.2.2.3	LCD_WRITE_A0	3262
13.3.2.2.4	LCD_WRITE_A1	3263
13.3.2.2.5	LCD_WRITEM_A1	3263
13.3.2.2.6	LCD_WRITE	3263
13.3.2.2.7	LCD_WRITEM	3263
13.4	Non-readable displays	3265
13.5	Display orientation	3266
13.5.1	Driver based configuration of display orientation	3266
13.5.1.1	Run-time configuration	3266
13.5.1.2	Compile-time configuration	3266
13.5.2	Runtime rotation	3267
13.5.2.1	LCD_ROTATE_AddDriver()	3268
13.5.2.2	LCD_ROTATE_AddDriverEx()	3269
13.5.2.3	LCD_ROTATE_DecSel()	3270
13.5.2.4	LCD_ROTATE_DecSelEx()	3271
13.5.2.5	LCD_ROTATE_IncSel()	3272
13.5.2.6	LCD_ROTATE_IncSelEx()	3273
13.5.2.7	LCD_ROTATE_SetCallback()	3274
13.5.2.8	LCD_ROTATE_SetSel()	3275
13.5.2.9	LCD_ROTATE_SetSelEx()	3276
13.5.3	Function based configuration of display orientation	3277
13.5.3.1	GUI_SetOrientation()	3278
13.5.3.2	GUI_SetOrientationEx()	3279
13.5.4	Orientation flags	3280

13.6	Display driver callback function .....	3281
13.6.1	Commands passed to the callback function .....	3281
13.6.1.1	LCD_X_INITCONTROLLER .....	3281
13.6.1.2	LCD_X_ON .....	3281
13.6.1.3	LCD_X_OFF .....	3281
13.6.1.4	LCD_X_SETALPHA .....	3281
13.6.1.5	LCD_X_SETLUTENTRY .....	3282
13.6.1.6	LCD_X_SETORG .....	3282
13.6.1.7	LCD_X_SETPOS .....	3282
13.6.1.8	LCD_X_SETSIZE .....	3283
13.6.1.9	LCD_X_SETVIS .....	3283
13.6.1.10	LCD_X_SETVRAMADDR .....	3284
13.6.1.11	LCD_X_SHOWBUFFER .....	3284
13.7	Detailed display driver descriptions .....	3285
13.7.1	GUIDRV_BitPlains .....	3285
13.7.1.1	Supported hardware .....	3285
13.7.1.2	Driver selection .....	3285
13.7.1.3	Display data RAM organization .....	3286
13.7.1.4	RAM requirements .....	3286
13.7.1.5	Hardware configuration .....	3286
13.7.1.6	Additional run-time configuration .....	3286
13.7.1.7	GUIDRV_BitPlains_Config() .....	3288
13.7.2	GUIDRV_Dist .....	3289
13.7.2.1	Supported hardware .....	3289
13.7.2.2	Driver selection .....	3289
13.7.2.3	RAM requirements .....	3289
13.7.2.4	Run-time configuration .....	3289
13.7.2.5	GUIDRV_Dist_AddDriver() .....	3290
13.7.3	GUIDRV_FlexColor .....	3291
13.7.3.1	Supported hardware .....	3291
13.7.3.2	Driver selection .....	3291
13.7.3.3	Display data RAM organization .....	3291
13.7.3.4	RAM requirements .....	3292
13.7.3.5	Run-time configuration API .....	3292
13.7.3.6	Commands supported by LCD_SetDevFunc() .....	3292
13.7.3.7	Configuration API .....	3293
13.7.3.7.1	GUIDRV_FlexColor_SetFunc() .....	3295
13.7.3.7.2	GUIDRV_FlexColor_Config() .....	3299
13.7.3.7.3	GUIDRV_FlexColor_SetOrientation() .....	3300
13.7.3.7.4	GUIDRV_FlexColor_SetInterface66712_B9() .....	3301
13.7.3.7.5	GUIDRV_FlexColor_SetInterface66715_B9() .....	3301
13.7.3.7.6	GUIDRV_FlexColor_SetInterface66712_B18() .....	3302
13.7.3.7.7	GUIDRV_FlexColor_SetInterface66715_B18() .....	3302
13.7.3.7.8	GUIDRV_FlexColor_SetReadFunc66709_B16() .....	3303
13.7.3.7.9	GUIDRV_FlexColor_SetReadFunc66712_B9() .....	3305
13.7.3.7.10	GUIDRV_FlexColor_SetReadFunc66715_B9() .....	3305
13.7.3.7.11	GUIDRV_FlexColor_SetReadFunc66712_B16() .....	3306
13.7.3.7.12	GUIDRV_FlexColor_SetReadFunc66715_B16() .....	3306
13.7.3.7.13	GUIDRV_FlexColor_SetReadFunc66720_B16() .....	3308
13.7.3.7.14	GUIDRV_FlexColor_SetReadFunc66772_B8() .....	3309
13.7.3.7.15	GUIDRV_FlexColor_SetReadFunc66772_B16() .....	3310
13.7.4	GUIDRV_IST3088 .....	3311
13.7.4.1	Supported hardware .....	3311
13.7.4.2	Driver selection .....	3311
13.7.4.3	Display data RAM organization .....	3311
13.7.4.4	RAM requirements .....	3311
13.7.4.5	Run-time configuration .....	3311
13.7.4.5.1	GUIDRV_IST3088_SetBus16() .....	3313
13.7.4.6	Required GUI_PORT_API routines .....	3313
13.7.4.7	Special requirements .....	3313

13.7.5	GUIDRV_Lin .....	3314
13.7.5.1	Supported hardware .....	3314
13.7.5.2	Color depth and display orientation .....	3314
13.7.5.3	Driver selection .....	3315
13.7.5.4	Display data RAM organization .....	3316
13.7.5.5	RAM requirements .....	3317
13.7.5.6	Compile-time configuration .....	3317
13.7.5.7	Run-time configuration .....	3317
13.7.5.7.1	GUIDRV_Lin_SetThreshold() .....	3318
13.7.5.8	Commands supported by LCD_SetDevFunc() .....	3318
13.7.5.9	Configuration example .....	3318
13.7.5.10	Using the Lin driver in systems with cache memory .....	3319
13.7.6	GUIDRV_S1D13C00 .....	3320
13.7.6.1	Supported hardware .....	3320
13.7.6.2	Display orientation .....	3320
13.7.6.3	Driver selection .....	3321
13.7.6.4	Display data RAM organization 1bpp .....	3321
13.7.6.5	Display data RAM organization 6 + 2bpp .....	3321
13.7.6.6	RAM requirements .....	3321
13.7.6.7	Run-time configuration .....	3322
13.7.6.7.1	GUIDRV_S1D13C00_Config() .....	3323
13.7.6.7.2	GUIDRV_S1D13C00_SetBaseAddress() .....	3324
13.7.6.7.3	GUIDRV_S1D13C00_SetBus() .....	3325
13.7.7	GUIDRV_S1D13L04 .....	3326
13.7.8	GUIDRV_S1D13513 .....	3326
13.7.8.1	Supported hardware .....	3326
13.7.8.2	Driver selection .....	3326
13.7.8.3	Display data RAM organization .....	3327
13.7.8.4	RAM requirements .....	3327
13.7.8.5	Basic function .....	3327
13.7.8.6	Run-time configuration .....	3327
13.7.8.6.1	GUIDRV_S1D13L04_Config() .....	3328
13.7.8.6.2	GUIDRV_S1D13513_Config() .....	3328
13.7.8.6.3	GUIDRV_S1D13L04_SetBus16() .....	3329
13.7.8.6.4	GUIDRV_S1D13513_SetBus16() .....	3329
13.7.9	GUIDRV_S1D13L02 .....	3330
13.7.10	GUIDRV_S1D13748 .....	3330
13.7.10.1	Supported hardware .....	3330
13.7.10.2	Basic function .....	3330
13.7.10.3	Driver selection .....	3330
13.7.10.4	Display data RAM organization .....	3331
13.7.10.5	RAM requirements .....	3331
13.7.10.6	Run-time configuration .....	3331
13.7.10.6.1	GUIDRV_S1D13L02_Config() .....	3332
13.7.10.6.2	GUIDRV_S1D13748_Config() .....	3332
13.7.10.6.3	GUIDRV_S1D13L02_SetBus16() .....	3333
13.7.10.6.4	GUIDRV_S1D13748_SetBus16() .....	3333
13.7.10.7	Required GUI_PORT_API routines .....	3333
13.7.10.8	Special requirements .....	3333
13.7.11	GUIDRV_S1D13L01 .....	3334
13.7.12	GUIDRV_S1D13781 .....	3334
13.7.12.1	Supported hardware .....	3334
13.7.12.2	Display orientation .....	3334
13.7.12.3	Driver selection .....	3334
13.7.12.4	Display data RAM organization .....	3335
13.7.12.5	RAM requirements .....	3335
13.7.12.6	Run-time configuration .....	3335
13.7.12.6.1	GUIDRV_S1D13L01_Config() .....	3337
13.7.12.6.2	GUIDRV_S1D13781_Config() .....	3337
13.7.12.6.3	GUIDRV_S1D13L01_SetBusSPI() .....	3338

13.7.12.6.4	GUIDRV_S1D13781_SetBusSPI()	3338
13.7.12.6.5	GUIDRV_S1D13L01_SetOrientation()	3339
13.7.12.6.6	GUIDRV_S1D13781_SetOrientation()	3339
13.7.12.7	Required GUI_PORT_API routines	3339
13.7.12.8	Optional functions	3339
13.7.12.9	Additional information	3340
13.7.13	GUIDRV_S1D15G00	3341
13.7.13.1	Supported hardware	3341
13.7.13.2	Driver selection	3341
13.7.13.3	Display data RAM organization	3341
13.7.13.4	RAM requirements	3341
13.7.13.5	Run-time configuration	3342
13.7.13.5.1	GUIDRV_S1D15G00_Config()	3343
13.7.13.5.2	GUIDRV_S1D15G00_SetBus8()	3344
13.7.13.6	Required GUI_PORT_API routines	3344
13.7.13.7	Configuration example	3344
13.7.14	GUIDRV_SH_MEM	3345
13.7.14.1	Supported hardware	3345
13.7.14.2	Display orientation	3345
13.7.14.3	Driver selection	3346
13.7.14.4	Display data RAM organization 1bpp	3346
13.7.14.5	Display data RAM organization 3bpp	3346
13.7.14.6	RAM requirements	3346
13.7.14.7	Run-time configuration	3346
13.7.14.7.1	GUIDRV_SH_MEM_Config()	3348
13.7.14.7.2	GUIDRV_SH_MEM_3_Config()	3348
13.7.14.7.3	GUIDRV_SH_MEM_SetBus8()	3349
13.7.14.7.4	GUIDRV_SH_MEM_3_SetBus8()	3349
13.7.14.8	Required GUI_PORT_API routines	3350
13.7.14.9	Configuration Example	3350
13.7.15	GUIDRV_SLin	3351
13.7.15.1	Supported hardware	3351
13.7.15.2	Color depth and display orientation	3351
13.7.15.3	Driver selection	3352
13.7.15.4	Display data RAM organization	3352
13.7.15.5	RAM requirements	3352
13.7.15.6	Run-time configuration	3352
13.7.15.6.1	GUIDRV_SLin_Config()	3354
13.7.15.6.2	GUIDRV_SLin_SetBus8()	3355
13.7.15.6.3	GUIDRV_SLin_SetS1D13700()	3356
13.7.15.6.4	GUIDRV_SLin_SetSSD1325()	3357
13.7.15.6.5	GUIDRV_SLin_SetSSD1848()	3358
13.7.15.6.6	GUIDRV_SLin_SetT6963()	3359
13.7.15.6.7	GUIDRV_SLin_SetUC1617()	3360
13.7.15.7	Configuration example	3361
13.7.16	GUIDRV_SLinEPD	3362
13.7.16.1	Description	3362
13.7.16.2	Supported hardware	3362
13.7.16.3	Color depth and display orientation	3363
13.7.16.4	Driver selection	3363
13.7.16.5	Display data RAM organization	3363
13.7.16.6	RAM requirements	3363
13.7.16.7	Run-time configuration	3364
13.7.16.7.1	GUIDRV_SLinEPD_Config()	3365
13.7.16.7.2	GUIDRV_SLinEPD_EnableFastMode()	3366
13.7.16.7.3	GUIDRV_SLinEPD_EnablePartialMode()	3367
13.7.16.7.4	GUIDRV_SLinEPD_SetBus8()	3368
13.7.16.7.5	GUIDRV_SLinEPD_SetSSD1673()	3369
13.7.16.7.6	GUIDRV_SLinEPD_SetUC8451()	3370
13.7.16.8	Configuration example	3371



13.7.17	GUIDRV_SPage .....	3372
13.7.17.1	Supported hardware .....	3372
13.7.17.2	Color depth and display orientation .....	3372
13.7.17.3	Driver selection .....	3373
13.7.17.4	Display data RAM organization .....	3374
13.7.17.5	RAM requirements .....	3374
13.7.17.6	Run-time configuration .....	3374
13.7.17.6.1	GUIDRV_SPage_Config() .....	3376
13.7.17.6.2	GUIDRV_SPage_SetBus8() .....	3377
13.7.17.6.3	GUIDRV_SPage_Set1502() .....	3378
13.7.17.6.4	GUIDRV_SPage_Set1510() .....	3379
13.7.17.6.5	GUIDRV_SPage_Set1512() .....	3380
13.7.17.6.6	GUIDRV_SPage_SetST75256() .....	3381
13.7.17.6.7	GUIDRV_SPage_SetST75320() .....	3382
13.7.17.6.8	GUIDRV_SPage_SetST7591() .....	3383
13.7.17.6.9	GUIDRV_SPage_SetUC1610() .....	3384
13.7.17.6.10	GUIDRV_SPage_SetUC1611() .....	3385
13.7.17.6.11	GUIDRV_SPage_SetUC1628() .....	3386
13.7.17.6.12	GUIDRV_SPage_SetUC1638() .....	3387
13.7.17.7	Configuration Example .....	3388
13.7.18	GUIDRV_SSD1322 .....	3389
13.7.18.1	Supported hardware .....	3389
13.7.18.2	Driver selection .....	3389
13.7.18.3	Display data RAM organization .....	3389
13.7.18.4	RAM requirements .....	3389
13.7.18.5	Run-time configuration .....	3389
13.7.18.5.1	GUIDRV_SSD1322_Config() .....	3390
13.7.18.5.2	GUIDRV_SSD1322_SetBus8() .....	3391
13.7.18.6	Required GUI_PORT_API routines .....	3392
13.7.18.7	Configuration example .....	3392
13.7.19	GUIDRV_SSD1926 .....	3393
13.7.19.1	Supported hardware .....	3393
13.7.19.2	Color depth and display orientation .....	3393
13.7.19.3	Driver selection .....	3393
13.7.19.4	Display data RAM organization .....	3393
13.7.19.5	RAM requirements .....	3394
13.7.19.6	Run-time configuration .....	3394
13.7.19.6.1	GUIDRV_SSD1926_Config() .....	3395
13.7.19.6.2	GUIDRV_SSD1926_SetBus16() .....	3396
13.7.19.7	Required GUI_PORT_API routines .....	3396
13.7.19.8	Configuration Example .....	3396
13.7.20	GUIDRV_UC1698G .....	3398
13.7.20.1	Supported Hardware .....	3398
13.7.20.2	Color depth and display orientation .....	3398
13.7.20.3	Driver selection .....	3398
13.7.20.4	Display data RAM organization .....	3399
13.7.20.5	RAM requirements .....	3399
13.7.20.6	Run-time configuration .....	3399
13.7.20.6.1	GUIDRV_UC1698G_Config() .....	3400
13.7.20.6.2	GUIDRV_UC1698G_SetBus8() .....	3401
13.7.20.6.3	GUIDRV_UC1698G_SetBus16() .....	3402
13.7.20.7	Required GUI_PORT_API routines .....	3403
13.7.21	GUIDRV_CompactColor_16 .....	3404
13.7.21.1	Supported Hardware .....	3404
13.7.21.2	Driver selection and configuration .....	3404
13.7.21.3	Display data RAM organization .....	3405
13.7.21.4	RAM requirements .....	3405
13.7.21.5	Compile-time configuration .....	3405
13.7.21.6	Additional configuration switches .....	3407
13.7.21.7	Configuration example .....	3407

13.7.22	GUIDRV_Fujitsu_16 .....	3409
13.7.22.1	Supported hardware .....	3409
13.7.22.2	Driver selection and configuration .....	3409
13.7.22.3	Available configuration macros (compile time configuration) ..	3409
13.7.22.4	Display data RAM organization .....	3409
13.7.22.5	RAM requirements .....	3409
13.7.22.6	Hardware configuration .....	3410
13.7.22.7	Additional configuration switches .....	3410
13.7.23	GUIDRV_Page1bpp .....	3411
13.7.23.1	Supported hardware .....	3411
13.7.23.2	Driver selection and configuration .....	3411
13.7.23.3	Compile-time configuration .....	3411
13.7.23.4	RAM requirements .....	3412
13.7.23.5	Additional driver functions .....	3412
13.7.23.6	Hardware configuration .....	3413
13.7.23.7	Additional configuration switches .....	3413
13.7.24	GUIDRV_07X1 .....	3414
13.7.24.1	Supported hardware .....	3414
13.7.24.2	Driver selection and configuration .....	3414
13.7.24.3	Display data RAM organization .....	3415
13.7.24.4	RAM requirements .....	3415
13.7.24.5	Additional driver functions .....	3415
13.7.24.6	Hardware configuration .....	3415
13.7.24.7	Additional configuration switches .....	3416
13.7.25	GUIDRV_6331 .....	3417
13.7.25.1	Supported hardware .....	3417
13.7.25.2	Driver selection and configuration .....	3417
13.7.25.3	Display data RAM organization .....	3418
13.7.25.4	RAM requirements .....	3418
13.7.25.5	Hardware configuration .....	3418
13.7.25.6	Additional configuration switches .....	3418
13.7.25.7	Special requirements .....	3419
13.7.26	GUIDRV_7528 .....	3420
13.7.26.1	Supported hardware .....	3420
13.7.26.2	Driver selection and configuration .....	3420
13.7.26.3	Display data RAM organization .....	3421
13.7.26.4	RAM requirements .....	3421
13.7.26.5	Hardware configuration .....	3421
13.7.26.6	Additional configuration switches .....	3422
13.7.27	GUIDRV_7529 .....	3423
13.7.27.1	Supported hardware .....	3423
13.7.27.2	Driver selection and configuration .....	3423
13.7.27.3	Display data RAM organization .....	3424
13.7.27.4	RAM requirements .....	3424
13.7.27.5	Hardware configuration .....	3425
13.7.27.6	Additional configuration switches .....	3425
13.8	LCD layer and display driver API .....	3426
13.8.1	Display driver API .....	3426
13.8.1.1	"Get" group .....	3428
13.8.1.1.1	LCD_GetBitsPerPixel() .....	3428
13.8.1.1.2	LCD_GetBitsPerPixelEx() .....	3429
13.8.1.1.3	LCD_GetNumColors() .....	3430
13.8.1.1.4	LCD_GetNumColorsEx() .....	3431
13.8.1.1.5	LCD_GetPosEx() .....	3432
13.8.1.1.6	LCD_GetVRAMAddr() .....	3433
13.8.1.1.7	LCD_GetVRAMAddrEx() .....	3434
13.8.1.1.8	LCD_GetVXSize() .....	3435
13.8.1.1.9	LCD_GetVYSize() .....	3435
13.8.1.1.10	LCD_GetVXSizeEx() .....	3436
13.8.1.1.11	LCD_GetVYSizeEx() .....	3436

13.8.1.1.12	LCD_GetXMag()	3437
13.8.1.1.13	LCD_GetYMag()	3437
13.8.1.1.14	LCD_GetXMagEx()	3438
13.8.1.1.15	LCD_GetYMagEx()	3438
13.8.1.1.16	LCD_GetXSize()	3439
13.8.1.1.17	LCD_GetYSize()	3439
13.8.1.1.18	LCD_GetXSizeEx()	3440
13.8.1.1.19	LCD_GetYSizeEx()	3440
13.8.1.2	"Set" group	3441
13.8.1.2.1	LCD_SetAlphaEx()	3441
13.8.1.2.2	LCD_SetAlphaModeEx()	3442
13.8.1.2.3	LCD_SetChromaEx()	3443
13.8.1.2.4	LCD_SetChromaModeEx()	3444
13.8.1.2.5	LCD_SetPosEx()	3445
13.8.1.2.6	LCD_SetVisEx()	3446
13.8.1.3	Configuration group	3447
13.8.1.3.1	LCD_SetBufferPtr()	3447
13.8.1.3.2	LCD_SetBufferPtrEx()	3448
13.8.1.3.3	LCD_Off()	3449
13.8.1.3.4	LCD_OffEx()	3450
13.8.1.3.5	LCD_On()	3451
13.8.1.3.6	LCD_OnEx()	3452
13.8.1.3.7	LCD_Refresh()	3453
13.8.1.3.8	LCD_RefreshEx()	3454
13.8.1.3.9	LCD_SetDevFunc()	3455
13.8.1.3.10	LCD_SetMaxNumColors()	3460
13.8.1.3.11	LCD_SetSizeEx()	3461
13.8.1.3.12	LCD_SetVRAMAddrEx()	3462
13.8.1.3.13	LCD_SetVSizeEx()	3463
13.8.1.4	Cache group	3464
13.8.1.4.1	LCD_ControlCache()	3464
14	Touch drivers	3465
14.1	GUIMTDRV_TangoC32	3466
14.1.1	Supported hardware	3466
14.1.2	Driver initialization	3466
14.1.3	GUIMTDRV_TangoC32 API	3466
14.1.3.1	GUIMTDRV_TangoC32_Init()	3467
14.2	GUITDRV_ADS7846	3469
14.2.1	Supported hardware	3469
14.2.2	Driver initialization	3469
14.2.3	GUITDRV_ADS7846 API	3469
14.2.3.1	GUITDRV_ADS7846_Config()	3470
14.2.3.2	GUITDRV_ADS7846_Exec()	3472
14.2.3.3	GUITDRV_ADS7846_GetLastVal()	3473
15	Performance and Resource Usage	3474
15.1	Performance	3475
15.1.1	Driver benchmark	3475
15.1.2	Image drawing performance (Bitmap, BMP and GIF)	3476
15.1.3	Image drawing performance (JPEG)	3477
15.1.3.1	STM32F769I (STM32F769I-Discovery)	3477
15.1.3.2	R7FA6M3AH3CFC (EK-RA6M3G)	3477
15.2	RAM requirements	3479
15.2.1	Display driver	3479
15.2.2	Multibuffering	3479
15.2.3	Antialiasing	3479
15.2.4	Memory devices	3479
15.2.5	Widgets	3479

15.2.6	Fonts .....	3480
15.2.7	Core .....	3480
15.2.8	Stack .....	3480
15.2.9	Orientation device .....	3480
15.2.10	Language module .....	3480
15.3	Memory requirements of example applications .....	3481
15.3.1	Measurement Environment .....	3481
15.3.2	Included Content .....	3481
15.3.3	'Hello World' application .....	3482
15.3.3.1	Configuration .....	3482
15.3.3.2	Memory Requirement .....	3482
15.3.4	Window manager application .....	3483
15.3.4.1	Configuration .....	3483
15.3.4.2	Memory Requirement .....	3483
15.4	Optimizing footprint .....	3484
15.4.1	Optimizing RAM requirement .....	3484
15.4.2	Optimizing ROM requirement .....	3484
16	Support .....	3485
16.1	Problems with tool chain (compiler, linker) .....	3486
16.1.1	Compiler crash .....	3486
16.1.2	Compiler warnings .....	3486
16.1.3	Compiler errors .....	3486
16.1.4	Linker problems .....	3487
16.2	Problems with hardware/driver .....	3488
16.3	Problems with API functions .....	3489
16.4	Problems with the performance .....	3490
16.5	Contacting support .....	3491
16.6	FAQ .....	3492
17	Indexes .....	3493
17.1	Function index .....	3494
17.2	Type index .....	3525

# Chapter 1

## Introduction to emWin

---

This introduction gives some information about this document. It also gives an overview of what features emWin consists of and what it requires.

## 1.1 Purpose of this document

This guide describes how to install, configure and use the emWin graphical user interface for embedded applications. It also explains the internal structure of the software and all the functions which are offered by emWin and intended for direct use (API, Application Programming Interface). Before actually using emWin, you should read or at least glance through this manual in order to become familiar with the software. The following steps are recommended:

- Copy the emWin files to your computer.
- Go through the chapter *Getting Started* on page 90
- Use the simulator in order to become more familiar with what the software can do (refer to the chapter *Simulation* on page 192).
- Expand your program using the rest of the manual for reference.

## 1.2 Requirements

A target system is not required in order to develop software with emWin; most of the software can be developed using the simulator. However, the final purpose is usually to be able to run the software on a target system.

### 1.2.1 Target system (hardware)

Your target system must:

- Have a CPU (16/32 bits)
- Have a CPU with 64 bits (LP64 and LLP64 data model)
- Have a minimum of RAM and ROM
- Have a full graphic display (any type and any resolution)

The RAM needs to be 8-, 16- and 32-bit accessible. Memory requirements vary depending on which parts of the software are used and how efficient your target compiler is. It is therefore not possible to specify precise values, but the following applies to typical systems.

#### Small systems (no Window Manager)

- RAM: 2 KBytes \*
- Stack: 600 Bytes \*
- ROM: 10-25 KBytes \*

#### Big systems (including Window Manager and widgets)

- RAM: 20 KBytes \*
- Stack: 1200 Bytes \*
- ROM: 30-120 KBytes \*

\* Depending on the functionality used. The numbers above are only a rough estimation and can not reflect the exact requirements of an application. RAM requirement can be increased significantly when using large memory devices or when drawing PNG images. ROM requirements increase according to the number of fonts and/or images used in the application. All values are rough estimates and cannot be guaranteed. More details can be found in the chapter *Performance and Resource Usage* on page 3474.

#### Note

emWin can also be compiled for 64 bit architectures using a LP64 or LLP64 data model. Within the source code of emWin 64 bit data types are defined to ensure memory is accessed properly. Depending on which compiler is used to compile emWin it can be necessary to adapt the definition of `PTR_ADDR` to access addresses beyond the 32 bit range.

The definition of the 64 bit data models can be found in the file `Global.h` which is located in the `GUI\Core` directory of the emWin source code. If your architecture is not covered by the defines in `Global.h` please make sure to define `PTR_ADDR` in `GUIConf.h` according to your architecture.

### 1.2.2 Development environment (compiler)

The CPU used is of no importance; only an ANSI-compliant C compiler complying with at least one of the following international standard is required:

- ISO/IEC/ANSI 9899:1990 (C90) with support for C++ style comments (`///  
//`)
- ISO/IEC 9899:1999 (C99)
- ISO/IEC 14882:1998 (C++)

If your compiler has some limitations, let us know and we will inform you if these will be a problem when compiling the software. Any compiler for 16/32-bit CPUs or DSPs that we know of can be used. A C++ compiler is not required, but can be used. The application program can therefore also be programmed in C++ if desired.

**Limitation**

The code of emWin requires a 'char' type of 8 bits. If a 'char' is 16 bits the code of emWin does not work right.



## 1.3 Features

emWin is designed to provide an efficient, processor- and display controller-independent graphical user interface for any application that operates with a graphical display. It is compatible with single-task and multi-task environments, with a proprietary operating system or with any commercial RTOS. emWin is shipped as C source code. It may be adapted to any size physical and virtual display with any display controller and CPU. Its features include the following:

### General

- Any (monochrome, grayscale or color) display with any controller supported (if the right driver is available).
- Any interface supported using configuration macros.
- May work without display controller on smaller displays.
- Display-size configurable.
- Characters and bitmaps may be written at any point on the display, not just on even-numbered byte addresses.
- Routines are optimized for both size and speed.
- Compile time switches allow for different optimizations.
- For slower display controllers, display can be cached in memory, reducing access to a minimum and resulting in very high speed.
- Virtual display support; the virtual display can be larger than the actual display.

### Graphic library

- Bitmaps of different color depths supported.
- Bitmap Converter available.
- Fast line/point drawing (without floating-point usage).
- Very fast drawing of rectangles, circles, polygons and many more shapes.
- Anti-aliased drawing of shapes in different qualities.
- Sub-pixel anti-aliased rendering.
- Different drawing modes.

### Fonts

- A variety of different fonts are shipped with the basic software: 4×6, 6×8, 6×9, 8×8, 8×9, 8×16, 8×17, 8×18, 24×32, and proportional fonts with pixel-heights of 8, 10, 13, 16. For more information, see chapter *Fonts* on page 656.
- New fonts can be defined and simply linked in.
- Only the fonts used by the application are actually linked to the resulting executable, resulting in minimum ROM usage.
- Using the Font Converter, any font available on the host system can be converted for use in emWin.
- Scalable iType and TTF fonts are supported.

### String/value output routines

- Routines to show values in decimal, binary, hexadecimal, any font.
- Routines to edit values in decimal, binary, hexadecimal, any font.

### Window Manager (WM)

- Complete window management including clipping. Overwriting of areas outside a window's client area is impossible.
- Windows can be moved and resized.
- Callback routines supported (usage optional).
- WM uses minimum RAM (approx. 50 bytes per window).

### Widgets for PC-like or smartphone-like look and feel

- Widgets (window objects, also known as controls) are available. They manage their appearance and their user input themselves and are easy to use through their API.

## Touch-screen & mouse support

- For window objects such as the button widget, emWin offers touch-screen and mouse support.

## PC tools

- **AppWizard** for building complete applications in a WYSIWYG editor without having to write C code.
- **Simulation** library for Win32 environments. The source code may be purchased additionally.
- **emWinView**, tool for viewing the framebuffer content while debugging with the simulation.
- **Bitmap Converter**, for converting common image formats into formats that are optimized for emWin.
- **Font Converter**, for converting common font formats into formats that are optimized for emWin.
- **emWinSPY**, tool for viewing runtime information about an emWin application (memory status, widgets, etc).
- **emWin4Web**, command line tool for building emWin applications to WebAssembly which can be run in any web browser.

# 1.4 Complete emWin system

The diagram below shows the individual components of a complete emWin system.

### Note

The touch controller components are marked as **optional** since they are not necessary for running emWin.

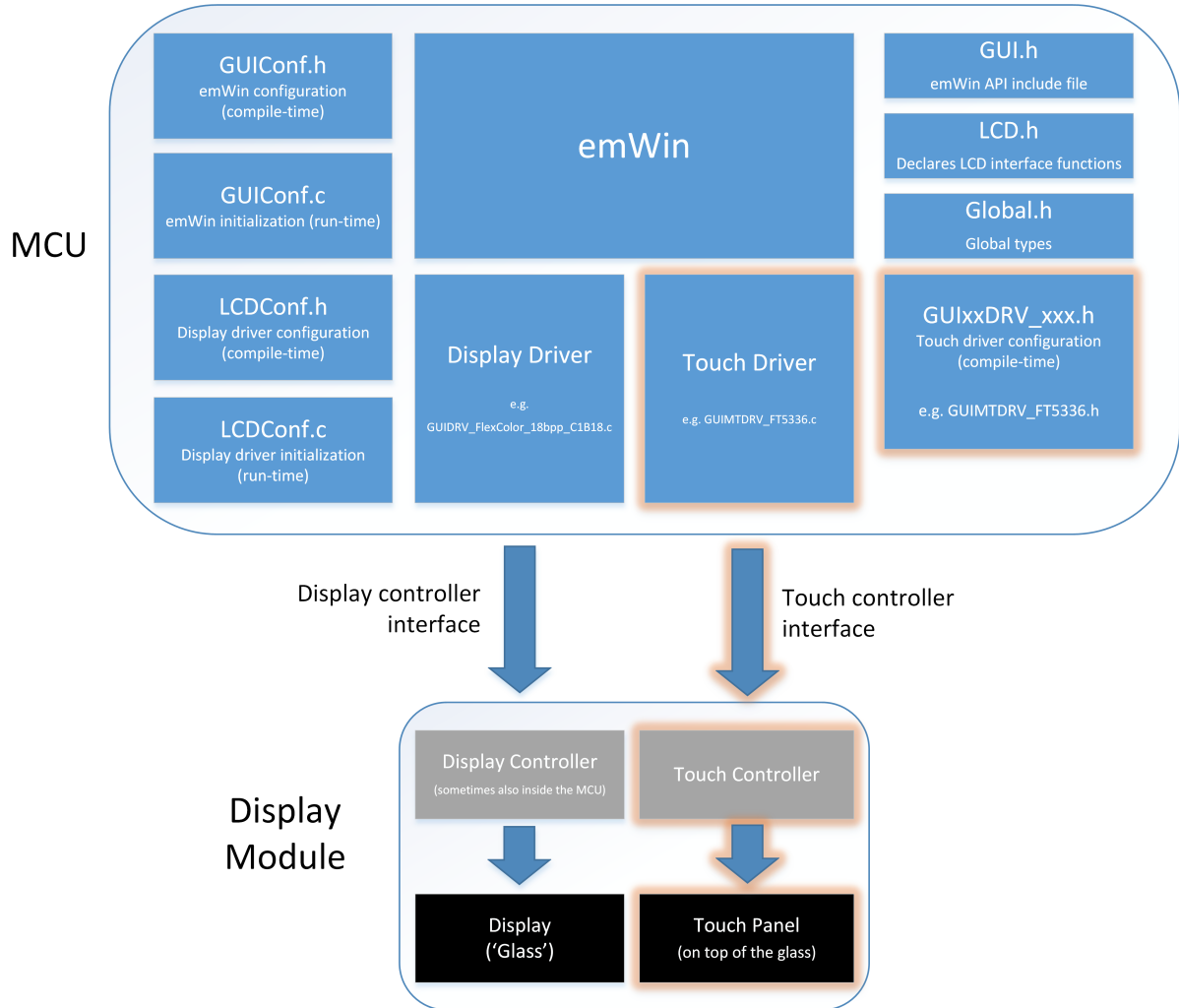



# 1.5 Examples and demos

To give you a better idea of what emWin can do, we have different demos available as “ready-to-use” simulation executables that you can find [here](#).

The source of the sample applications is located in the folder `Sample`. The folder `Sample\Application\GUIDemo` contains an application program showing many features of emWin. All examples are also available at [www.segger.com](http://www.segger.com). Example code in this documentation is provided as code snippet, which might require further modifications.

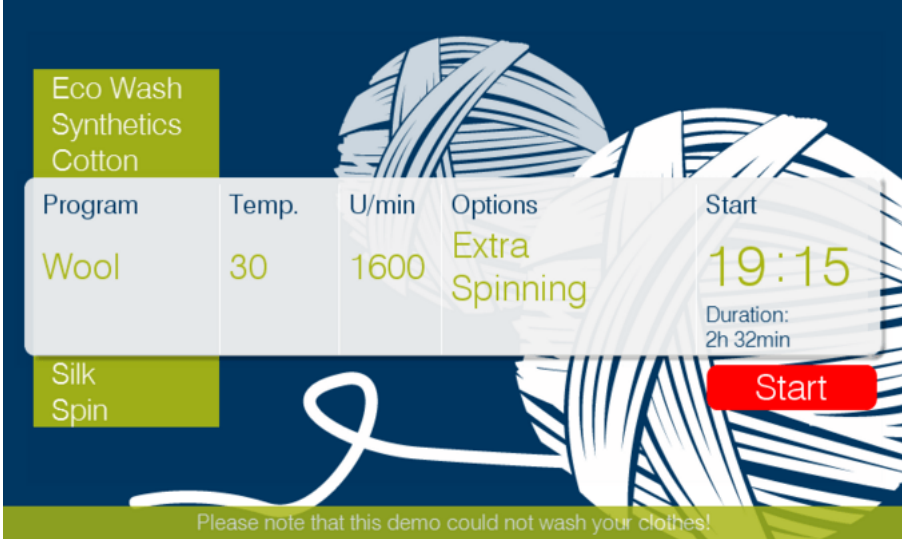
Listed below are some of the provided demos:

Demo name	Screenshot
<p><b>Temperature Control</b></p>	
<p><b>Washing Machine</b></p>	

Demo name	Screenshot
<b>Weather Forecast</b>	 <p>The screenshot displays a weather forecast for Berlin, Germany. The background features a scenic view of the Berlin Cathedral (Berliner Dom) and the TV Tower (Fernsehturm) under a clear blue sky. The forecast information is overlaid on the image:</p> <ul style="list-style-type: none"><li>Location: BERLIN</li><li>Current Time and Date: 15:20 SUNDAY 23 APR</li><li>Forecast for the next five days:<ul style="list-style-type: none"><li>MON: 28°C (partly cloudy)</li><li>TUE: 24°C (cloudy with rain)</li><li>WED: 25°C (partly cloudy)</li><li>THU: 29°C (sunny)</li><li>FRI: 30°C (partly cloudy)</li></ul></li></ul> <p>At the bottom of the forecast bar, there are five small circular indicators, with the first one (Monday) being white and the others being blue, indicating the current day in the forecast.</p>

## 1.6 AppWizard

With emWin's tool AppWizard, users are able to create complete and ready-to-run emWin applications. It incorporates many of emWin's core features such as widgets, animations, language management and motion support to be able to create stunning applications without writing any line of code. Therefore, no knowledge of the C language is required.

More information about AppWizard can be read under *AppWizard* on page 86 or on [our website](#).

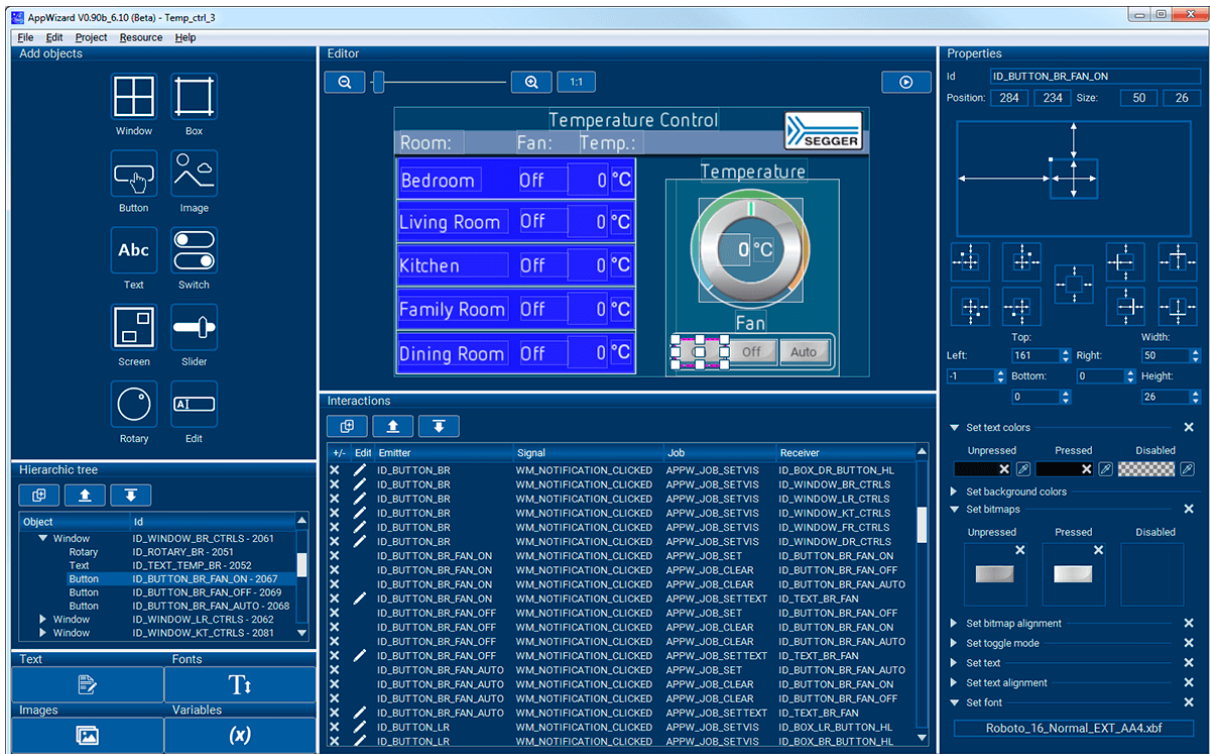

## 1.7 Screen and coordinates

The screen consists of many dots that can be controlled individually. These dots are called pixels. Most of the text and drawing functions that emWin offers in its API to the user program can write or draw on any specified pixel.

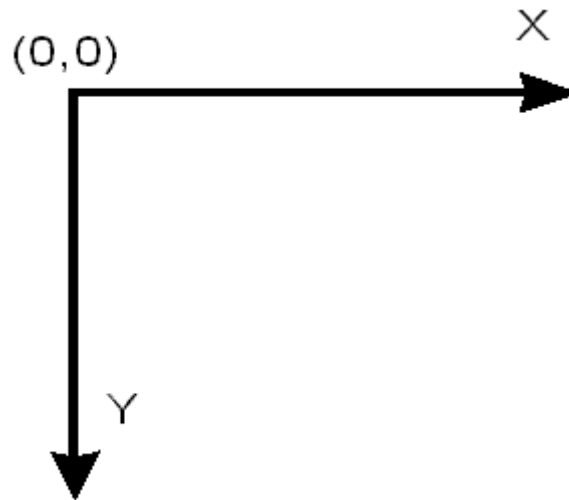

The horizontal scale is called the X-axis, whereas the vertical scale is called the Y-axis. Coordinates are denoted as a pair consisting of an X- and a Y-value (X, Y). The X-coordinate is always first in routines that require X and Y coordinates. The upper left corner of the display (or a window) has per default the coordinates (0,0). Positive X-values are always to the right; positive Y-values are always down. The above graph illustrates the coordinate system and directions of the X- and Y- axes. All coordinates passed to an API function are always specified in pixels.

## 1.8 How to connect the display to the microcontroller

emWin handles all access to the display. Virtually any display controller can be supported, independently of how it is accessed. For details, refer to the chapter *Configuration* on page 109. Also, get in contact with us if your display controller is not supported. We are currently writing drivers for all display controllers available on the market and may already have a proven driver for the display controller that you intend to use. It is usually very simple to write the routines (or macros) used to access the display in your application. SEGGER Microcontroller GmbH offers the service of making these customizations for you, if necessary with your target hardware. It does not really matter how the display is connected to the system as long as it is somehow accessible by software, which may be accomplished in a variety of ways. Most of these interfaces are supported by a driver which is supplied in source code form. This driver does not normally require modifications, but is configured for your hardware by making changes in the file `LCDConf.h`. Details about how to customize a driver to your hardware as necessary are provided in the chapter *Display drivers* on page 3252. The most common ways to access the display are described as follows. If you simply want to understand how to use emWin, you may skip this section.

### Display with memory-mapped display controller

The display controller is connected directly to the data bus of the system, which means the controller can be accessed just like a RAM. This is a very efficient way of accessing the display controller and is most recommended. The display addresses are defined to the segment `LCDSEG`, and in order to be able to access the display the linker/locator simply needs to be told where to locate this segment. The location must be identical to the access address in physical address space. Drivers are available for this type of interface and for different display controllers.

### Display with display controller connected to port / buffer

For slower display controllers used on fast processors, the use of port-lines may be the only solution. This method of accessing the display has the disadvantage of being somewhat slower than direct bus-interface but, particularly with a cache that minimizes the accesses to the display, the display update is not slowed down significantly. All that needs to be done is to define routines or macros which set or read the hardware ports/buffers that the display is connected to. This type of interface is also supported by different drivers for the different display controllers.

### Proprietary solutions: display without display controller

The display can also be connected without an display controller. In this case, the display data is usually supplied directly by the controller via a 4- or 8-bit shift register. These proprietary hardware solutions have the advantage of being inexpensive, but the disadvantage of using up much of the available computation time. Depending on the CPU, this can be anything between 20 and almost 100 percent; with slower CPUs, it is really not possible at all. This type of interface does not require a specific display driver because emWin simply places all the display data into the display cache. You yourself must write the hardware-dependent portion that periodically transfers the data in the cache memory to your display.



## 1.9 Data types

Since C does not provide data types of fixed lengths which are identical on all platforms, emWin uses, in most cases, its own data types as shown in the table below:

Data type	Definition	Description
I8	signed char	8-bit signed value
U8	unsigned char	8-bit unsigned value
I16	signed short	16-bit signed value
U16	unsigned short	16-bit unsigned value
I32	signed long	32-bit signed value
U32	unsigned long	32-bit unsigned value
I16P	signed short	16-bit (or more) signed value
U16P	unsigned short	16-bit (or more) unsigned value

For most 16/32-bit controllers, the settings will work fine. However, if you have similar defines in other sections of your program, you might want to change or relocate them. A recommended place is in the file `Global.h`.

# Chapter 2

## Getting Started

---

The following chapter provides an overview of the basic procedures for setting up and configuring emWin on your target system. It also includes a simple program example. If you find yourself unsure about certain areas, keep in mind that most topics are treated in greater detail in later chapters. You will most likely need to refer to other parts of the manual before you begin more complicated programming.

## 2.1 Recommended project structure

We recommend keeping emWin separate from your application files. It is good practice to keep all the program files (including the header files) together in the GUI subdirectories of your project's root directory. The directory structure should be similar to the one seen in the picture. This practice has the advantage of being very easy to update to newer versions of emWin by simply replacing the GUI\ directories. Your application files can be stored anywhere.

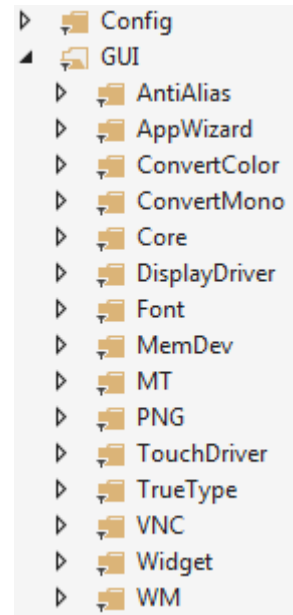

### Note

When updating to a newer emWin version:  
Since files may have been added, moved or deleted, the project directories may need to be updated accordingly.

## 2.2 Subdirectories

The following table shows the contents of all GUI subdirectories.

Directory	Contents
Config	Configuration files
GUI\AppWizard	AppWizard-related files
GUI\ConvertColor	Color conversion routines used for color displays
GUI\ConvertMono	Color conversion routines used for grayscale displays
GUI\Core	emWin core files
GUI\DisplayDriver	Display driver files
GUI\Font	Font files
Additional modules	
GUI\AntiAlias	Anti-aliasing support
GUI\MemDev	Memory Device support
GUI\MT	MultiTouch support
GUI\VNC	VNC support
GUI\Widget	Widget library
GUI\WM	Window Manager
Third-party modules (not included in shipments)	
GUI\PNG	PNG support with libpng library.
GUI\TrueType	TTF and BDF font support with FreeType library.

### Additional modules

These modules are sold separately from emWin BASE packages and can be optionally purchased with a shipment.

The emWin PRO package contains the following modules by default: AntiAlias, MemDev, Widget and WM.

### Third-party modules

These modules are not included in the commercially sold emWin shipments for legal reasons. All modules containing third-party software can be downloaded for free from our website. You can find the download links in the corresponding sub-chapters.

### 2.2.1 Include directories

You should make sure that the include path contains the following directories (the order of inclusion is of no importance):

- Config
- GUI\AppWizard
- GUI\Core
- GUI\DisplayDriver
- GUI\Widget (if using the widget library)
- GUI\WM (if using Window Manager)

#### Note

Always make sure that you have only one version of each file!

It is frequently a major problem when updating to a new version of emWin if you have old files included and therefore mix different versions. If you keep emWin in the directories as

suggested (and only in these), this type of problem cannot occur. When updating to a newer version, you should be able to keep your configuration files and leave them unchanged. For safety reasons, we recommend backing up (or at least renaming) the `GUI\` directories prior to updating.

## 2.3 Adding emWin to the target program

You basically have a choice between including only the source files that you are actually going to use in your project, which will then be compiled and linked, or creating a library and linking the library file. If your tool chain supports “smart” linking (linking in only the modules that are referenced and not those that are not referenced), there is no real need to create a library at all, since only the functions and data structures which are required will be linked. If your tool chain does not support “smart” linking, a library makes sense, because otherwise everything will be linked in and the program size will be excessively large. For some CPUs, we have example projects available to help you get started.

## 2.4 Creating a library

Building a library from the sources is a simple procedure. The first step is to copy the batch files (located under `Sample\Makelib`) into your project's root directory. That means the parent directory containing the `Config` and the `GUI` folder. Then, make any necessary changes. There are a total of four batch files which need to be copied, described in the table below. The main file, `Makelib.bat`, will be the same for all systems and requires no changes. To build a library for your target system, you will normally need to make slight modifications to the other three smaller files. Finally, start the file `Makelib.bat` to create the library. The batch files assume that your `GUI` and `Config` subdirectories are set up as recommended.

The procedure for creating a library is illustrated in the flow chart below. The `Makelib.bat` file first calls `Prep.bat` to prepare the environment for the tool chain. Then it calls `CC.bat` for every file to be included in the library. It does this as many times as necessary. `CC.bat` adds each object file to a list that will be used by `lib.bat`. When all files to be added to the library have been listed, `Makelib.bat` then calls `lib.bat`, which uses a librarian to put the listed object files into the actual library. Of course you are free to create libraries in another way.

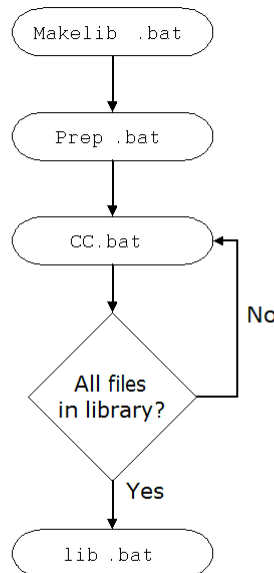

It is not recommended to create an emWin library including a compile-time configurable display driver. Detailed information about the configurability of emWin display drivers can be found in the section *Available display drivers* on page 3253.

File	Description
<code>Makelib.bat</code>	Main batch file. No modification required.
<code>Prep.bat</code>	Called by <code>Makelib.bat</code> to prepare environment for the tool chain to be used.
<code>CC.bat</code>	Called by <code>Makelib.bat</code> for every file to be added to the library; creates a list of these object files which will then be used in the next step by the librarian in the <code>lib.bat</code> file.
<code>Lib.bat</code>	Called by <code>Makelib.bat</code> to put the object files listed by <code>CC.bat</code> into a library.

The files as shipped assume that a Microsoft compiler is installed in its default location. If all batch files are copied to the root directory (directly above `GUI`) and no changes are made

at all, a simulation library will be generated for the emWin simulation. In order to create a target library, however, it will be necessary to modify `Prep.bat`, `CC.bat` and `lib.bat`.

## 2.4.1 Adapting the library batch files to a different system

The following will show how to adapt the files by an example adaptation for the ARM Cortex-M4 CPU.

### Adapting Prep.bat

`Prep.bat` is called at the beginning of `Makelib.bat`. As described above its job is to set the environment variables for the used tools and the environment variable `PATH`, so that the batch files can call the tools without specifying an absolute path. Assuming the compiler is installed in the folder `C:\MTOOL` the file `Prep.bat` could look as follows:

```
@ECHO OFF
GOTO START

*****
*
* File      : Prep.bat
* Parameters: None
* Purpose   : Sets path and other environment variables as required by tool chain
*
* This file is written for the CM4 GCC toolchain
*
* It needs to be modified if the compiler is installed in a different location.
*
*****

:START
ECHO PREP.BAT:           Preparing environment for CM4 GCC

if "%_PREP_CM4_GCC%" == "_PREP_CM4_GCC_" goto cont
set _PREP_CM4_GCC=_PREP_CM4_GCC_

SET TOOLPATH=c:\Tool\C\Segger\SES_V452\
set PATH=%TOOLPATH%\gcc\arm-none-eabi\bin\;%PATH%
SET GNU_C_INCLUDE=%TOOLPATH%\include
:cont
```

### Adapting CC.bat

The job of `CC.bat` is to compile the passed source file and adding the file name of the object file to a link list. When starting `MakeLib.bat` it creates the following subdirectories relative to its position:

Directory	Contents
Lib	This folder should contain the library file after the build process.
Temp\Output	Should contain all the compiler output and the link list file. Will be deleted after the build process.
Temp\Source	<code>MakeLib.bat</code> uses this folder to copy all source and header files used for the build process. Will be deleted after the build process.

The object file should be created (or moved) to `Temp\Output`. This makes sure all the output will be deleted after the build process. Also the link list should be located in the output folder. The following shows an example for the GCC compiler:

```
@ECHO OFF
GOTO START
```



```

*****
*
* File      : CC.bat
* Parameters: %1 Name of file to compile (without extension; .c is added)
* Purpose   : Compile one file and add it to the list of files to put in
*           : Library
*
* This file as is uses the GCC Compiler
*
*****

:START
ECHO CC.BAT:           Compiling %1.c with GCC compiler

if "%COMPILER_TEST_SAMPLES%"=="1" (
    ccl -mthumb -mcpu=cortex-m4 -mlittle-endian -mfpv4-sp-d16 -mfloat-abi=softfp -DDEBUG=1 -DSKIP_TEST -O3 -mfpv4-sp-d16 -mfloat-abi=softfp -fomit-frame-pointer -quiet -Wall -Wno-missing-field-initializers -Wextra -nostdinc "-I %GNU_C_INCLUDE%" -D__CROSSWORKS_ARM -fno-builtin -o temp/Output/%1.l temp/Source/%1.c
) else (
    ccl -mthumb -mcpu=cortex-m4 -mlittle-endian -mfpv4-sp-d16 -mfloat-abi=softfp -DDEBUG=1 -DSKIP_TEST -O3 -mfpv4-sp-d16 -mfloat-abi=softfp -fomit-frame-pointer -quiet -Wall -Wextra -Wlogical-op -Wfloat-equal -pedantic -nostdinc "-I %GNU_C_INCLUDE%" -D__CROSSWORKS_ARM -fno-builtin -o temp/Output/%1.l temp/Source/%1.c
)

IF ERRORLEVEL 1 PAUSE
as -mthumb -mcpu=cortex-m4 -mlittle-endian -mfpv4-sp-d16 -mfloat-abi=softfp -mfpv4-sp-d16 -mfloat-abi=softfp --traditional-format -EL "temp/Output/%1.l" -o "temp/Output/%1.o"
IF ERRORLEVEL 1 PAUSE
IF NOT EXIST temp\Lib.dat @ECHO create lib/libGUI.a>temp\Lib.dat
@ECHO addmod temp\output/%1.o>>temp/lib.dat

```

## Adapting Lib.bat

After all source files have been compiled Lib.bat will be called from MakeLib.bat. The job is to create a library file using the link list created by CC.bat. The destination folder of the library file should be the Lib folder created by MakeLib.bat. The following shows an example for the GCC toolchain:

```

@ECHO OFF
GOTO START

*****
*
* File      : Lib.bat
* Parameters: None
* Purpose   : Put all (object) files in linklist into the library
*
* This file is written for the GCC toolchain
*
*****

:START

ECHO MAKELIB.BAT:           Creating GUI target library using GCC tool-chain

REM *****
REM   Create library
REM *****

IF EXIST Lib\GUI_GNU.LIB DEL Lib\GUI_GNU.LIB
@ECHO save>>temp\lib.dat
@ECHO end>>temp\lib.dat
ar -M<temp/lib.dat

```

```
IF ERRORLEVEL 1 PAUSE
```

## 2.5 C files to include in the project

Generally speaking, you need to include the core C files of emWin, the display driver, all font files you plan to use and any optional modules you have ordered with emWin:

- All C files of the folder `Config`
- All C files of the folder `GUI\Core`
- The fonts you plan to use (located in `GUI\Font`)
- Display driver: All C files of the folder `GUI\DisplayDriver`.

### Additional software packages

If you plan to use additional, optional modules you must also include their C files:

- Gray scale converting functions: all C files located in `GUI\ConvertMono`
- Color conversion functions: all C files located in `GUI\ConvertColor`
- Antialiasing: all C files located in `GUI\AntiAlias`
- AppWizard: all C files located in `GUI\AppWizard`
- Memory Devices: all C files located in `GUI\MemDev`
- VNC support: all C files located in `GUI\VNC`
- Widget library: all C files located in `GUI\Widget`
- Window Manager: all C files located in `GUI\WM`

### Target specifics

For displays with indirect interface hardware routines must be included. Examples for several kinds of indirect interface routines are available under `Sample\LCD_X_Port`.

### RTOS specifics

- If emWin is intended to be used with an RTOS, some RTOS dependent functions need to be implemented. emWin comes with several sample files including implementations for common RTOS packages (called `GUI_X_<RTOS>.c`), as well as the file `GUI_X_Ex.c` which just contains place holders of the required functions and might be used to make emWin work with any RTOS.
- If multitasking is not required (access of the display by one task only) the file `GUI_X.c` may be used as a starting point for a custom implementation. The sample files can be found in the folder `Sample\GUI_X` which is contained in the emWin package.

### Additional information

Be sure to include `GUI.h` in all emWin accessing source files.

## 2.6 CMake support

Since V6.46, emWin now also comes with CMake scripts. The CMake support makes it possible to include emWin in other CMake scripts or compile a library.

### CMake options

To setup emWin and configure the CMake build, there are a few variables that can be set.

CMake option	Default value	Description
GUI_CM_CONFIG_DIR	<i>none</i>	The emWin configuration directory containing these files: LCDConf.c/.h, PIDConf.c/.h and GUIConf.c/.h.
GUI_CM_DISPLAY_DRIVERS	"all"	Semicolon-separated list of display drivers to be built. The default is that all display drivers in the directory will be built. An example list would be: "GUIDRV_Lin;GUIDRV_FlexColor"
GUI_CM_BUILD_APPWIZARD	OFF	Build with AppWizard subdirectory.
GUI_CM_BUILD_CORE	ON	Build with Core subdirectory.
GUI_CM_BUILD_CONVERTMONO	ON	Build with ConvertMono subdirectory.
GUI_CM_BUILD_CONVERTCOLOR	ON	Build with ConvertColor subdirectory.
GUI_CM_BUILD_DISPLAYDRIVER	ON	Build with DisplayDrivers subdirectory.
GUI_CM_BUILD_TOUCHDRIVER	ON	Build with TouchDrivers subdirectory.
GUI_CM_BUILD_FONT	ON	Build with Fonts subdirectory.
GUI_CM_BUILD_ANTIALIAS	ON	Build with AntiAliasing subdirectory.
GUI_CM_BUILD_WM	ON	Build with Window Manager subdirectory.
GUI_CM_BUILD_WIDGET	ON	Build with Widgets subdirectory.
GUI_CM_BUILD_MEMDEV	ON	Build with Memory Devices subdirectory.
GUI_CM_BUILD_PNG	OFF	Build with PNG subdirectory.
GUI_CM_BUILD_TRUETYPE	OFF	Build with TrueType subdirectory.
GUI_CM_BUILD_VNC	OFF	Build with VNC subdirectory.
GUI_CM_BUILD_MT	OFF	Build with MultiTouch subdirectory.

### CMake integration

The main CMake script that has to be executed or included is in the main GUI directory, GUI\CMakeLists.txt

## Example

An excerpt of a CMake script that includes emWin in its build could look like this:

```
#
# Include all sub-directories
#
set(GUI_CM_BUILD_APPWIZARD      ON)
set(GUI_CM_BUILD_CORE          ON)
set(GUI_CM_BUILD_CONVERTMONO   ON)
set(GUI_CM_BUILD_CONVERTCOLOR  ON)
set(GUI_CM_BUILD_DISPLAYDRIVER ON)
set(GUI_CM_BUILD_TOUCHDRIVER   ON)
set(GUI_CM_BUILD_FONT          ON)
set(GUI_CM_BUILD_ANTIALIAS     ON)
set(GUI_CM_BUILD_WM            ON)
set(GUI_CM_BUILD_WIDGET       ON)
set(GUI_CM_BUILD_MEMDEV       ON)
set(GUI_CM_BUILD_PNG          ON)
set(GUI_CM_BUILD_TRUETYPE     ON)
set(GUI_CM_BUILD_VNC          ON)
set(GUI_CM_BUILD_MT           ON)
#
# Configure config dir and display drivers
#
set(GUI_CM_DISPLAY_DRIVERS "GUIDRV_Lin;")
set(GUI_CM_CONFIG_DIR      "${CMAKE_CURRENT_LIST_DIR}/Config")
#
# Add emWin
#
add_subdirectory(GUI)
```

## 2.7 Configuring emWin

The `Config` folder should contain all configuration files. The chapter *Configuration* on page 109 explains in detail how emWin should be configured.

### 2.7.1 Configuration macros

The following types of configuration macros are available:

#### Binary switch "B"

Switches can have a value of either 0 or 1, where 0 means deactivated and 1 means activated (actually anything other than 0 would work, but using 1 makes it easier to read a `config` file). These switches can enable or disable a certain functionality or behavior. Switches are the simplest form of configuration macro.

#### Numerical value "N"

Numerical values are used somewhere in the code in place of a numerical constant. Typical examples are in the configuration of the resolution of a display.

#### Selection switch "S"

Selection switches are used to select one out of multiple options where only one of those options can be selected. A typical example might be the selection of the type of display controller used, where the number selected denotes which source code (in which display driver) is used to generate object code.

#### Alias "A"

A macro which operates like a simple text substitute. An example is `U8`, which is replaced by the preprocessor with `unsigned char`.

#### Function replacement "F"

Macros can basically be treated like regular functions although certain limitations apply, as a macro is still put into the code as simple text replacement. Function replacements are mainly used to add specific functionality to a module (such as the access to a display) which is highly hardware-dependent. This type of macro is always declared using brackets (and optional parameters).

#### Type replacement "T"

Type replacement macros allow changing the types of certain values.

## 2.8 Initializing emWin

The following functions should be used to initialize and 'de-initialize' emWin in order to start the configuration process (see chapter *Configuration* on page 109) or clear internal data from memory again.

Routine	Description
<code>GUI_Init()</code>	Initializes emWin internal data structures and variables.
<code>GUI_IsInitialized()</code>	Returns the initialization state of emWin.
<code>GUI_Exit()</code>	Clears emWin internal data from memory to make further calls of <code>GUI_Init()</code> possible.

### Code example

The section *The Hello world example program* on page 108 offers a code example that shows how emWin is initialized.

## 2.8.1 GUI\_Init()

### Description

Initializes emWin internal data structures and variables.

### Prototype

```
int GUI_Init(void);
```

### Return value

= 0        if successful.  
≠ 0        if the initialization of the display driver fails.

### Additional information

Executing this function is mandatory before using any emWin functions. The only exception is setting create flags for windows (see `WM_SetCreateFlags()`). If the Window Manager is used, the background window is created from within `GUI_Init()`. So if create flags are set up before `GUI_Init()` is called, the background window is created according to them.



## 2.8.2 GUI\_IsInitialized()

### Description

Returns the initialization state of emWin.

### Prototype

```
int GUI_IsInitialized(void);
```

### Return value

1	if emWin is already initialized
0	if not.

## 2.8.3 GUI\_Exit()

### Description

Clears emWin internal data from memory to make further calls of `GUI_Init()` possible.

### Prototype

```
void GUI_Exit(void);
```

### Additional information

This function should be used if emWin represents a part of the application which is not used continuously and therefore has to be able to be turned on and off again. Please note that after `GUI_Exit()` was called emWin will not work properly until `GUI_Init()` is called again.

## 2.9 Using emWin with target hardware

The following is just a basic outline of the general steps that should be taken when starting to program with emWin. All steps are explained further in subsequent chapters.

### Step 1: Configuring emWin

The first step is usually to customize emWin. For details about the configuration, refer to the chapter *Configuration* on page 109.

### Step 2: Defining access addresses or access routines

For memory-mapped display controllers, the access addresses of the display simply need to be defined in the configuration file of the display controller. For port/buffer-accessed display controllers, interface routines must be defined. Examples of the required routines are available under `Sample\LCD_X_Port`.

### Step 3: Compiling, linking and testing the example code

emWin comes with example code for both single- and multitask environments. Compile, link and test these little example programs until you feel comfortable doing so.

### Step 4: Modifying the example program

Make simple modifications to the example programs. Add additional commands such as displaying text in different sizes on the display, showing lines and so on.

### Step 5: In multitask applications: adapt to your OS (if necessary)

If multiple tasks should be able to access the display simultaneously, the macros `GUI_MAX-TASK` and `GUI_OS` come into play, as well as the file `GUItask.c`. For details and example adaptations, refer to the chapter *Configuration* on page 109.

### Step 6: Write your own application using emWin

By now you should have a clearer understanding of how to use emWin. Think about how to structure the program your application requires and use emWin by calling the appropriate routines. Consult the reference chapters later in this manual, as they discuss the specific emWin functions and configuration macros that are available.

## 2.10 The "Hello world" example program

In the following we will show the "Hello world" example program. If you like to see a wide range of emWin based sample applications as well as further simple tutorial applications, please have a look in the `Sample` folder of your emWin shipment or visit the "emWin Samples" section on [www.segger.com](http://www.segger.com).

A "Hello world" program has been used as a starting point for C programming since the early days, because it is essentially the smallest program that can be written. An emWin "Hello world" program is shown below and is available as `BASIC>HelloWorld.c` in the `Sample\Tutorial` folder shipped with emWin. The whole purpose of the program is to write "Hello world" in the upper left corner of the display. In order to be able to do this, the hardware of the application, the display controller and the GUI must be initialized first. emWin is initialized by a simple call of `GUI_Init()` in the beginning of the program. In this example, we assume that the hardware of your application is already initialized. The "Hello world" program looks as follows:

```
#include "GUI.h"
void MainTask(void) {
    GUI_Init();
    GUI_DispString("Hello world!");
    while(1);
}
```

### Adding functionality to the "Hello world" program

Our little program has not been doing too much so far. We can now extend the functionality a bit: after displaying "Hello world", we would like the program to start counting on the display in order to be able to estimate how fast outputs to the display can be made. We can simply add a bit of code to the loop at the end of the main program, which is essentially a call to the function that displays a value in decimal form.

The example is available as `BASIC>Hello1.c` in the `Sample` folder.

```
#include "GUI.h"
void MainTask(void) {
    int i = 0;
    GUI_Init();
    GUI_DispString("Hello world!");
    while(1) {
        GUI_DispDecAt( i++, 20,20,4);
        if (i > 9999) {
            i = 0;
        }
    }
}
```

# Chapter 3

## Configuration

---

Before emWin can be used on a target system, the software needs to be configured. Configuring means modifying the configuration files which usually reside in the (sub)directory `Config`. We try to keep the configuration as simple as possible, but there are some configuration routines which need to be modified in order for the system to work properly.

The following items need to be configured:

- Memory area to be used by emWin
- Display driver to be used for drawing operations
- Color conversion routines to be used
- Display controller initialization
- Framebuffer cache
- Hardware acceleration
- Hardware JPEG decoding

The following chapter explains the configuration of emWin in detail.

## 3.1 What needs to be configured?

The configuration is basically divided into two parts: GUI-configuration and LCD-configuration. GUI-configuration means configuration of available features, default colors and - fonts and the configuration of available memory. The LCD-configuration is more hardware dependent and has to define the physical size of the display, the display driver and the color conversion routines to be used. For details about color conversion routines, refer to the chapter *Colors* on page 604.

If a hardware is used which offers acceleration features as for example available with the ChromeART accelerator of some of the STM32 devices, the chapter *Hardware acceleration* on page 150 contains more information.

A further part is configuring the simulation. But this is not required for the target hardware and not part of this chapter. For details about configuring the simulation, refer to the chapter *Simulation* on page 192.

## 3.2 Run-time- and compile-time configuration

There are C and include files to be configured. The configuration in the header files is fixed at compile time and can not be changed whereas the configuration done in the C files can be changed at run-time. This makes it possible to create a library which is largely configuration independent and can be used with any display and any driver. This requires that the configuration routines described in this chapter are not part of the library but of the application.

### 3.3 Initialization process of emWin

The illustration shows the process of initialization. To initialize emWin, the application only has to call `GUI_Init()`. The configuration routines explained below are called during the internal initialization process.

`GUI_Init()`

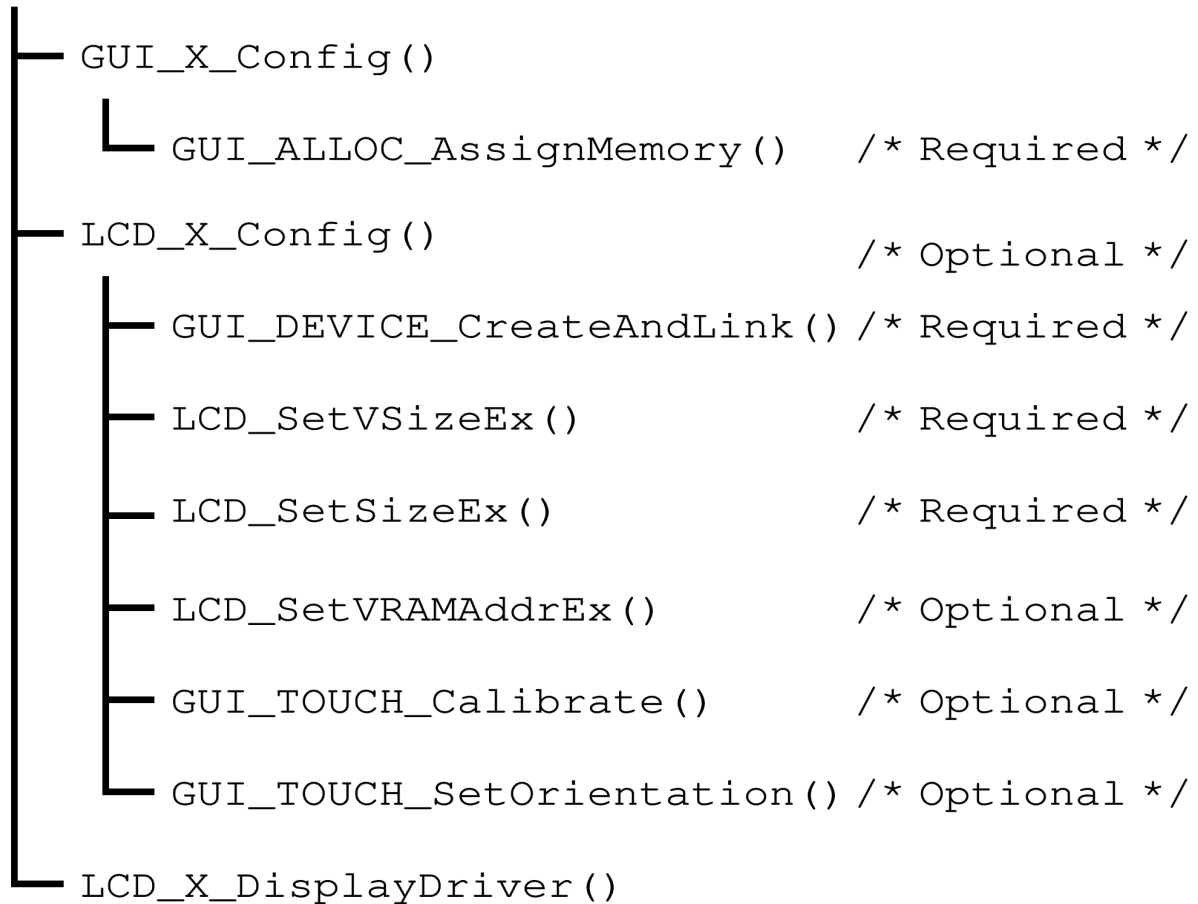

#### GUI\_X\_Config()

It is called at the very first beginning of the initialization process to make sure that memory is assigned to emWin. Within this routine `GUI_ALLOC_AssignMemory()` must be called to assign a memory block to emWin. The functions are explained later in this chapter.

#### LCD\_X\_Config()

This function is called immediately after `GUI_X_Config()`. The main purpose of this routine is creating a display driver device and selecting the color conversion routines. Further it is responsible for setting the display size. If a touch screen is used it should also be configured here.

#### LCD\_X\_DisplayDriver()

At a later point of the initialization process the function `LCD_X_DisplayDriver()` is called. It is called directly by the display driver. During the initialization process the task of this routine is putting the display controller into operation. A detailed description of the routine follows later in this chapter.



## 3.4 Run-time configuration

The following table shows the available run-time configuration files located in the subfolder Config:

Configuration file	Purpose
GUIConf.c	Configuration of available memory.
LCDConf.c	Configuration of the display size, the display driver and the color conversion routines.
SIMConf.c	Configuration of the simulation (not part of this chapter).
GUI_X.c	Configuration of timing routines.

### 3.4.1 Customizing GUIConf.c

The purpose of this module is to provide emWin with the function `GUI_X_Config()` which is responsible for assigning a memory block to the memory management system. This requires knowledge about the memory requirement of the used components. The separate chapter Performance and Resource Usage contains a detailed description of the memory requirements (RAM and ROM) of the individual emWin modules.

Per default GUIConf.c is located in the (sub)directory and contains the routine `GUI_X_Config()` which is responsible to assign a memory block to emWin. It is not cogently required to leave it in the file GUIConf.c. The routine `GUI_X_Config()` can be located anywhere in the application.

Calling this function is the very first thing done during the process of initialization. It is responsible to assign a memory block to emWin. This block is managed by the internal memory management system. Please also refer to `GUI_ALLOC_AssignMemory()`.

#### 3.4.1.1 API functions to be used in GUI\_X\_Config()

The following table shows the API functions which must be called within `GUI_X_Config()`:

Routine	Description
<code>GUI_ALLOC_AssignMemory()</code>	The function assigns the one and only memory block to emWin which is used by the internal memory management system.
<code>GUI_RegisterAfterInitHook()</code>	Registers a hook function which gets called after the GUI has been initialized.
<code>GUI_SetOnErrorFunc()</code>	Sets the hook function which is called from <code>GUI_ErrorOut()</code> .
<code>GUI_SetOnLogFunc()</code>	Sets the hook function which is called from <code>GUI_Log()</code> .
<code>GUI_SetOnWarnFunc()</code>	Sets the hook function which is called from <code>GUI_Warn()</code> .
<code>GUI_TASK_GetMaxTask()</code>	Returns the maximum number of possible tasks when multitasking is enabled.
<code>GUI_TASK_SetMaxTask()</code>	Sets the maximum number of tasks from which emWin can be accessed when multitasking is enabled.

### 3.4.1.1.1 GUI\_ALLOC\_AssignMemory()

#### Description

The function assigns the one and only memory block to emWin which is used by the internal memory management system. This function should be called typically from GUI\_X\_Config().

#### Prototype

```
void GUI_ALLOC_AssignMemory(void * p,
                             U32   NumBytes);
```

#### Parameters

Parameter	Description
<code>p</code>	Pointer to the memory block which should be used by emWin.
<code>NumBytes</code>	Size of the memory block in bytes.

#### Additional information

Note that not the complete memory block can be used by the application, because a small overhead is used by the management system itself. Each memory block requires approximately 12 additional bytes for management purpose. The assigned memory block needs to be accessible 8, 16 and 32 bit wise. It is used by emWin internally for memory allocation. Instead of using malloc() and free() the internal memory management uses that block for memory allocation. It is not used as frame buffer.

### 3.4.1.1.2 GUI\_RegisterAfterInitHook()

#### Description

Registers a hook function which gets called after the GUI has been initialized.

#### Prototype

```
void GUI_RegisterAfterInitHook(void (*pFunc)(),
                               GUI_REGISTER_INIT * pRegisterInit);
```

#### Parameters

Parameter	Description
<code>pFunc</code>	Pointer to a function to be called.
<code>pRegisterInit</code>	Pointer to a GUI_REGISTER_INIT structure.

#### Additional information

It is possible to set multiple function to be called after the GUI has been initialized. This requires a dedicated GUI\_REGISTER\_INIT structure for each function.

```
static void _Init0(void) {
}
static void _Init1(void) {
}
void GUI_X_Config(void) {
    static GUI_REGISTER_INIT RegisterInit0;
    static GUI_REGISTER_INIT RegisterInit1;

    static U32 aMemory[GUI_NUMBYTES / 4];
    GUI_ALLOC_AssignMemory(aMemory, GUI_NUMBYTES);
    GUI_SetDefaultFont(&GUI_Font6x8);
    GUI_RegisterAfterInitHook(_Init0, &RegisterInit0);
    GUI_RegisterAfterInitHook(_Init1, &RegisterInit1);
}
```

### 3.4.1.1.3 GUI\_SetOnErrorFunc()

#### Description

Sets the hook function which is called from `GUI_ErrorOut()`.

#### Prototype

```
void GUI_SetOnErrorFunc(void (*pFunc)(const char * s));
```

#### Parameters

Parameter	Description
<code>pFunc</code>	Pointer to the function which should be called by <code>GUI_ErrorOut()</code> .

#### Additional information

The hook function gets a short error description in the string passed to the routine. It should contain the module and the function where the error occurred and a short description.

See also the description of `GUI_ErrorOut()`.

### 3.4.1.1.4 GUI\_SetOnLogFunc()

#### Description

Sets the hook function which is called from `GUI_Log()`.

#### Prototype

```
void GUI_SetOnLogFunc(void (*pFunc)(const char * s));
```

#### Parameters

Parameter	Description
<code>pFunc</code>	Pointer to the function which should be called by <code>GUI_Log()</code> .

#### Additional information

The hook function gets a log message in the string passed to the routine. The string contains the module and the function from where the log was sent.

See also the description of `GUI_Log()`.

### 3.4.1.1.5 GUI\_SetOnWarnFunc()

#### Description

Sets the hook function which is called from GUI\_Warn().

#### Prototype

```
void GUI_SetOnWarnFunc(void ( *pFunc)(const char * s ));
```

#### Parameters

Parameter	Description
<code>pFunc</code>	Pointer to the function which should be called by GUI_Warn().

#### Additional information

The hook function gets a warning in the string passed to the routine. The string contains the module and the function where the error occurred and a short description.

See also the description of GUI\_Warn().

### 3.4.1.1.6 GUITASK\_GetMaxTask()

#### Description

Returns the maximum number of possible tasks when multitasking is enabled.

#### Prototype

```
int GUITASK_GetMaxTask(void);
```

#### Return value

Maximum number of possible tasks.

### 3.4.1.1.7 GUITASK\_SetMaxTask()

#### Description

Sets the maximum number of tasks from which emWin can be accessed when multitasking is enabled.

#### Prototype

```
void GUITASK_SetMaxTask(int MaxTask);
```

#### Parameters

Parameter	Description
MaxTask	Number of tasks from which emWin is used at most.

#### Additional information

This function is intended to be called from `GUI_X_Config()`. It is necessary to use this function when working with a pre-compiled library. Otherwise `GUI_MAXTASK` can be defined. Further information can be found under `GUI_MAXTASK` on page 3207.



## 3.4.2 Customizing LCDConf.c

The purpose of this module is to provide emWin with the required display configuration routine and the callback function for the display driver. These are the following functions:

Routine	Description
<code>LCD_X_Config()</code>	Configuration routine for creating the display driver device, setting the color conversion routines and the display size.
<code>LCD_X_DisplayDriver()</code>	Callback routine called by the display driver for putting the display controller into operation.

### 3.4.2.1 LCD\_X\_Config()

#### Description

As described in the table above this routine is responsible to create a display driver device, set the right color conversion routines and for configuring the physical display size.

#### Prototype

```
void LCD_X_Config(void);
```

#### Additional information

Depending on the used display driver it could also be required to set the video RAM address, initialize a custom palette or some else. For information about any additional requirements, refer to *Detailed display driver descriptions* on page 3285. The functions available for configuration purpose in this routine are listed and explained later in this chapter.

#### Example

The following shows a typical example implementation:

```
//  
// Set display driver and color conversion for 1st layer  
//  
GUI_DEVICE_CreateAndLink(GUIDRV_LIN_16, GUICC_565, 0, 0);  
//  
// Display driver configuration  
//  
LCD_SetSizeEx    (0, 320, 240);  
LCD_SetVSizeEx  (0, 320, 240);  
LCD_SetVRAMAddrEx(0, (void *)0x200000);
```

### 3.4.2.2 LCD\_X\_DisplayDriver()

#### Description

This is the callback function of the display driver. It is called by the display driver for several jobs. It passes a command and a pointer to a data structure to the callback routine. The command tells the callback function what should be done. If the command requires parameters they are passed through the data pointer `pData`. It points to a structure whose format depends on the command.

#### Prototype

```
int LCD_X_DisplayDriver(unsigned LayerIndex,
                      unsigned Cmd,
                      void * pData);
```

#### Parameters

Parameter	Description
<code>LayerIndex</code>	Zero based layer index.
<code>Cmd</code>	Command to be executed. Detailed descriptions below.
<code>pData</code>	Pointer to a data structure.

#### Elements of structure LCD\_X\_SETVRAMADDR\_INFO

Data type	Element	Description
<code>void *</code>	<code>pVRAM</code>	Pointer to the start address of the video RAM.

#### Return value

- 0 Command has been successfully executed.
- 1 Command is not handled by the function.
- 2 Error occurred.

#### Additional information

For more information about the commands passed to the routine by the display driver, refer to *Display drivers* on page 3252.

#### Examples

The folder `Sample\LCDConf` contains a lot of example implementations of this routine which can be used as starting point.

### 3.4.2.3 API functions to be used in LCD\_X\_Config()

The following table shows the API functions which are available for configuration purpose within `LCD_X_Config()`:

Routine	Description
<code>GUI_DEVICE_CreateAndLink()</code>	Creates a display driver device and associates the color conversion routines to be used.
<code>GUI_TOUCH_SetOrientation()</code>	The function configures the touch screen orientation.
<code>GUI_TOUCH_Calibrate()</code>	Changes the calibration at runtime.
<code>LCD_SetLUTEx()</code>	Sets the look-up table for the given layer.
<code>LCD_SetSizeEx()</code>	Sets the physical size of the visible area of the given display/layer.
<code>LCD_SetVRAMAddrEx()</code>	Sets the address of the video RAM.
<code>LCD_SetVSizeEx()</code>	Sets the size of the virtual display area.

Aside from the function `LCD_SetLUTEx()` the descriptions of the `LCD_...()` functions can be found in the chapter *Display drivers* on page 3252.

The descriptions of the `GUI_TOUCH_...()` functions can be found in the chapter *Touch screen driver* on page 829.

### 3.4.2.3.1 GUI\_DEVICE\_CreateAndLink()

#### Description

This routine creates the display driver device, sets the color conversion routines to be used for accessing the display and it links the driver device into the device list of the given layer. `LCD_X_Config()` is called immediately after `GUI_X_Config()`. This makes sure that the memory configuration already has been done and the driver is able to allocate memory. The required memory for a display driver device is approx. 50 bytes + the driver specific memory. For details about the memory requirements of the individual display drivers, refer to the chapter *Display drivers* on page 3252.

#### Prototype

```
GUI_DEVICE *GUI_DEVICE_CreateAndLink(const GUI_DEVICE_API * pDeviceAPI,
                                     const LCD_API_COLOR_CONV * pColorConvAPI,
                                     U16 Flags,
                                     int LayerIndex);
```

#### Parameters

Parameter	Description
<code>pDeviceAPI</code>	Pointer to the display driver to be used. The chapter <i>Display drivers</i> on page 3252 contains a table of the available display drivers.
<code>pColorConvAPI</code>	Pointer to the color conversion routines to be used. The chapter <i>Colors</i> on page 604 contains a table with the available color conversion routines.
<code>Flags</code>	Should be zero.
<code>LayerIndex</code>	Layer which should be managed by the driver.

#### Return value

On success the function returns a pointer to the created device object, otherwise it returns NULL.

#### Additional information

Note that the used driver also determines the display orientation in some cases. This differs from driver to driver. For details about the display orientation, refer to the chapter *Display drivers* on page 3252.

### 3.4.3 Customizing GUI\_X.c

This file is the location of the timing routines, the debugging routines and the kernel interface routines:

#### 3.4.3.1 Init routines

##### 3.4.3.1.1 GUI\_X\_Init()

###### Description

This function is being called on initialization of emWin.

###### Prototype

```
void GUI_X_Init(void);
```

###### Additional information

Typically used to initialize a hardware timer to provide a time base used by the timing related GUI\_X functions. This is not required when using an underlying RTOS.

## 3.4.3.2 Timing routines

### 3.4.3.2.1 GUI\_X\_Delay()

#### Description

Returns after a specified time period in milliseconds.

#### Prototype

```
void GUI_X_Delay(int Period);
```

#### Parameters

Parameter	Description
<code>Period</code>	<code>Period</code> in milliseconds.

### 3.4.3.2.2 GUI\_X\_ExecIdle()

#### Description

Called only from non-blocking functions of the Window Manager.

#### Prototype

```
void GUI_X_ExecIdle(void);
```

#### Additional information

Called when there are no longer any messages which require processing. In this case the GUI is up to date.



### 3.4.3.2.3 GUI\_X\_GetTime()

#### Description

Used by `GUI_GetTime()` to return the current system time in milliseconds.

#### Prototype

```
GUI_TIMER_TIME GUI_X_GetTime(void);
```

#### Return value

The current system time in milliseconds, of type integer.

### 3.4.3.3 Debug routines

#### 3.4.3.3.1 GUI\_X\_ErrorOut()

#### 3.4.3.3.2 GUI\_X\_Warn()

#### 3.4.3.3.3 GUI\_X\_Log()

##### Description

These routines are called by emWin with debug information in higher debug levels in case a problem (Error) or potential problem is discovered. The routines can be blank; they are not required for the functionality of emWin. In a target system, they are typically not required in a release (production) build, since a production build typically uses a lower debug level.

- Fatal errors are output using `GUI_X_ErrorOut()` if `(GUI_DEBUG_LEVEL ≥ 3)`
- Warnings are output using `GUI_X_Warn()` if `(GUI_DEBUG_LEVEL ≥ 4)`
- Messages are output using `GUI_X_Log()` if `(GUI_DEBUG_LEVEL ≥ 5)`

##### Prototypes

```
void GUI_X_ErrorOut(const char * s);
```

```
void GUI_X_Warn(const char * s);
```

```
void GUI_X_Log(const char * s);
```

##### Parameters

Parameter	Description
<code>s</code>	Pointer to the string to be sent.

##### Additional information

This routine is called by emWin to transmit error messages or warnings, and is required if logging is enabled. The GUI calls this function depending on the configuration macro `GUI_DEBUG_LEVEL`. The following table lists the permitted values for `GUI_DEBUG_LEVEL`:

Value	Symbolic name	Description
0	<code>GUI_DEBUG_LEVEL_NOCHECK</code>	No run-time checks are performed.
1	<code>GUI_DEBUG_LEVEL_CHECK_PARA</code>	Parameter checks are performed to avoid crashes. (Default for target system)
2	<code>GUI_DEBUG_LEVEL_CHECK_ALL</code>	Parameter checks and consistency checks are performed.
3	<code>GUI_DEBUG_LEVEL_LOG_ERRORS</code>	Errors are recorded.
4	<code>GUI_DEBUG_LEVEL_LOG_WARNINGS</code>	Errors and warnings are recorded. (Default for PC-simulation)
5	<code>GUI_DEBUG_LEVEL_LOG_ALL</code>	Errors, warnings and messages are recorded.

### 3.4.3.4 Kernel interface routines

Detailed descriptions for these routines may be found in *Execution Model: Single Task / Multitask* on page 3195.

## 3.4.4 Function replacement

The following table shows the API functions which are available for setting up custom defined functions for common purpose:

Routine	Description
<a href="#">GUI_SetpfMemcpy()</a>	Sets a custom function for memcpy operations.
<a href="#">GUI_SetpfMemset()</a>	Sets a custom function for memset operations.
<a href="#">GUI_SetpfStrcmp()</a>	Sets a custom function for string compare operations.
<a href="#">GUI_SetpfStrcpy()</a>	Sets a custom function for string copy operations.
<a href="#">GUI_SetpfStrlen()</a>	Sets a custom function for getting the length of a string.

### 3.4.4.1 GUI\_SetpfMemcpy()

#### Description

Sets a custom function for memcpy operations.

#### Prototype

```
void GUI_SetpfMemcpy  
    (void * ( *pFunc)(void * pDest , const void * pSrc , size_t Cnt ));
```

#### Parameters

Parameter	Description
<code>pFunc</code>	Function to be used

### 3.4.4.2 GUI\_SetpfMemset()

#### Description

Sets a custom function for memset operations.

#### Prototype

```
void GUI_SetpfMemset(void * ( *pFunc)(void * pDest , int c , size_t Cnt ));
```

#### Parameters

Parameter	Description
<code>pFunc</code>	Function to be used

### 3.4.4.3 GUI\_SetpfStrcmp()

#### Description

Sets a custom function for string compare operations.

#### Prototype

```
void GUI_SetpfStrcmp(int (*pFunc)(const char *, const char *));
```

#### Parameters

Parameter	Description
<code>pFunc</code>	Function to be used

### 3.4.4.4 GUI\_SetpfStrcpy()

#### Description

Sets a custom function for string copy operations.

#### Prototype

```
void GUI_SetpfStrcpy(char * ( *pFunc)(char * , const char * ));
```

#### Parameters

Parameter	Description
<code>pFunc</code>	Function to be used

### 3.4.4.5 GUI\_SetpfStrlen()

#### Description

Sets a custom function for getting the length of a string.

#### Prototype

```
void GUI_SetpfStrlen(size_t ( *pFunc)(const char * ));
```

#### Parameters

Parameter	Description
<code>pFunc</code>	Function to be used



## 3.5 Compile-time configuration

The following table shows the available compile time configuration files located in the sub-folder `Config`:

Configuration file	Purpose
<code>GUIConf.h</code>	Configuration of possible number of used layers, default fonts and colors and available features (e.g. Widgets).
<code>LCDCConf.h</code>	Configuration of the used display driver(s).

In case a precompiled emWin library is used, changing the configuration files will not have any effect until the library is compiled again with the required settings. This applies to all of the defines explained in the following sections.

### 3.5.1 Customizing GUIConf.h

As described above the file should contain the configuration of available features and the configuration of the default font. Each emWin shipment comes with a `GUIConf.h` file which includes a basic configuration which can be used as a starting point.

#### 3.5.1.1 Configuring the available features of emWin

The following table shows the available configuration macros:

Type	Macro	Default	Description
B	<code>GUI_OS</code>	0	Activate to enable multitasking support with multiple tasks calling emWin (see the chapter <i>Execution Model: Single Task / Multitask</i> on page 3195).
B	<code>GUI_SUPPORT_AA</code>	1	Enables support of anti-aliased drawing routines.
B	<code>GUI_SUPPORT_CURSOR</code>	(see expl.)	Per default cursors are enabled if either <code>GUI_SUPPORT_TOUCH</code> or <code>GUI_SUPPORT_MOUSE</code> has been enabled. If cursors should be shown without enabling one of these options it should be set to 1.
B	<code>GUI_SUPPORT_MEMDEV</code>	0	Enables optional Memory Device support.
B	<code>GUI_SUPPORT_MOUSE</code>	0	Enables the optional mouse support.
B	<code>GUI_SUPPORT_ROTATION</code>	1	Enables text rotation support.
B	<code>GUI_SUPPORT_SPY</code>	0	Enables support for emWinSPY.
B	<code>GUI_SUPPORT_TOUCH</code>	0	Enables optional touch-screen support.
T	<code>GUI_TIMER_TIME</code>	<code>int</code>	Defines the type which is used for time values by the emWin Timer functionality.
B	<code>GUI_WINSUPPORT</code>	0	Enables optional Window Manager support.
B	<code>GUI_SUPPORT_BIDI</code>	1	Enables BiDi support for emWin. Set to 0 if not required and to save some ROM.

#### 3.5.1.2 Default font and default color configuration

The following table shows the available configuration macros:

Type	Macro	Default	Description
N	<code>GUI_DEFAULT_BKCOLOR</code>	<code>GUI_BLACK</code>	Define the default background color.
N	<code>GUI_DEFAULT_COLOR</code>	<code>GUI_WHITE</code>	Define the default foreground color.
S	<code>GUI_DEFAULT_FONT</code>	<code>&amp;GUI_Font6x8</code>	Defines which font is used per default after <code>GUI_Init()</code> . If you do not use the default font, it makes sense to change to a different default, as

Type	Macro	Default	Description
			the default font is referenced by the code and will therefore always be linked. Please also refer to <code>GUI_SetDefaultFont()</code> which can be used for runtime configuration of the default font.

The default colors and fonts of the widgets which are part of the optional Window Manager can also be configured. For details, refer to the chapter *Widgets (window objects)* on page 1151.

### 3.5.1.3 Advanced GUI configuration options

The following table shows the available configuration macros:

Type	Macro	Default	Description
S	GUI_DEBUG_LEVEL	1 (target) 4 (simulation)	Defines the debug level, which determines how many checks (assertions) are performed by emWin and if debug errors, warnings and messages are output. Higher debug levels generate bigger code.
N	GUI_MAXTASK	4	Define the maximum number of tasks from which emWin is called to access the display when multitasking support is enabled (see the chapter <i>Execution Model: Single Task / Multitask</i> on page 3195).
F	GUI_MEMCPY	memcpy	This macro allows replacement of the memcpy function.
F	GUI_MEMSET	memset	This macro allows replacement of the memset function.
N	GUI_NUM_LAYERS	1	Defines the maximum of available layers/displays.
F	GUI_POST_INIT	-	Defines a function to be called at the end of <code>GUI_Init()</code> .
B	GUI_TRIAL_VERSION	0	Marks the compiler output as evaluation version.
B	GUI_WINSUPPORT	0	Enables optional Window Manager support.
N	GUI_PID_BUFFER_SIZE	5	Maximum number of PID events managed by the input buffer.
N	GUI_KEY_BUFFER_SIZE	10	Maximum number of key events managed by the input buffer.

#### 3.5.1.3.1 GUI\_MEMCPY (obsolete)

##### Note

Please refer to `GUI_SetpfMemcpy` on page 132.

This macro allows replacement of the memcpy function of the GUI. On a lot of systems, memcpy takes up a considerable amount of time because it is not optimized by the compiler manufacturer. emWin contains an alternative memcpy routine, which has been optimized for 32 bit CPUs. On a lot of systems this routine should generate faster code than the default memcpy routine. However, this is still a generic C routine, which in a lot of systems can be replaced by faster code, typically using either a different C routine, which is better optimized for the particular CPU or by writing a routine in Assembly language.

To use the optimized emWin routine add the following define to the file `GUIConf.h`:

```
#define GUI_MEMCPY GUI__memcpy
```

### 3.5.1.3.2 GUI\_MEMSET (obsolete)

#### Note

Please refer to *GUI\_SetpfMemset* on page 133.

This macro allows replacement of the memset function of the GUI. On a lot of systems, memset takes up a considerable amount of time because it is not optimized by the compiler manufacturer. We have tried to address this by using our own memset() Routine *GUI\_\_memset*. However, this is still a generic C routine, which in a lot of systems can be replaced by faster code, typically using either a different C routine, which is better optimized for the particular CPU, by writing a routine in Assembly language or using the DMA.

If you want to use your own memset replacement routine, add the define to the *GUIConf.h* file.

### 3.5.1.3.3 GUI\_POST\_INIT

It could make sense to have a function which is called after the GUI has been completely initialized. To be able to have that the macro could be defined as follows:

#### Example

```
#define GUI_POST_INIT CustomFunction();
```

### 3.5.1.3.4 GUI\_TRIAL\_VERSION

This macro can be used to mark the compiler output as an evaluation build. It should be defined if the software is given to a third party for evaluation purpose (typically with evaluation boards).

Note that a special license is required to do this; the most common licenses do not permit redistribution of emWin in source or object code (relinkable) form. Contact [sales@segger.com](mailto:sales@segger.com) if you would like to do this.

If *GUI\_TRIAL\_VERSION* is defined, the following message is shown when calling *GUI\_Init()*:

```
This software
contains an eval-
build of emWin.

A license is
required to use
it in a product.

www.segger.com
```

This message is always shown in the upper left corner of the display and is normally visible for 1 second. The timing is implemented by a call of *GUI\_X\_Delay(1000)*. The functionality of emWin is in no way limited if this switch is active.

#### Example

```
#define GUI_TRIAL_VERSION 1
```

## 3.5.2 Customizing LCDConf.h

This file contains general configuration options required for compiling the display driver(s) which need not to be changed at run-time. The available configuration options depend on the used display driver. For details about the available configuration options, refer to the chapter *Display drivers* on page 3252. The detailed driver description shows the available configuration options for each display driver.

## 3.6 Framebuffer cache

For any other display driver than `GUIDRV_Lin`, it is possible to use a framebuffer cache to prevent flickering while `emWin` is drawing a new frame. Another important use case for caching is when it is not possible to read back pixel data from an indirect display controller.

`emWin` offers two possible ways to use a framebuffer cache, both of which are explained below.

- Embedded caching: Cache integrated into a display driver
- `GUI_GCACHE`: Global, driver-independent caching module.

### 3.6.1 Embedded caching: Cache integrated into a display driver

Some display drivers have framebuffer caches directly embedded into its driver module.

The advantage of this caching strategy is that the cache is better adapted to the specific needs of the display controller(s) supported by the driver.

Another advantage is less overhead, because only one display driver device is present in the device chain, instead of two devices (one driver and one cache).

Below listed are display drivers that offer an embedded cache. The corresponding chapters go into more detail for which bit depths an embedded cache is supported.

- `GUIDRV_FlexColor`
- `GUIDRV_SPage`
- `GUIDRV_UC1698G`

### 3.6.2 `GUI_GCACHE`: Global cache with optional color reducer

The `GUI_GCACHE` module is a global caching module that is completely independent of any display driver.

#### When to use

Due to its versatility, there are a lot of cases where it makes sense to use this caching module. The following are example cases when it makes sense to use `GUI_GCACHE`:

- The display driver itself offers no embedded cache.
- The memory block for the cache should be used-allocated.
- There is not enough RAM to hold a cache with the bit depth of the controller, the bit depth needs to be reduced.

#### Example usage

To enable this cache, only a call of one of the creation functions is necessary after `GUI_Init()`. The line below enables a 4bpp GGACHE with 16 colors. The actual display driver created beforehand may have a different color depth.

```
GUI_GCACHE_Create(GUI_GCACHE_4, GUICC_16);
```

#### Reducing memory footprint with the optional color reducer

The `GUI_GCACHE` optionally allows to run the cache with a reduced bit depth. For example, a display runs in 16bpp but the RAM is limited that only a 4bpp cache would fit into the RAM. In this case, create the `GUI_GCACHE` for 4bpp with the desired 4bpp color conversion. When the 4bpp cache frame is sent to the display, the color indices are expanded to the actual color depth of the display.

## User allocated buffers

Through the routine `GUI_GCACHE_CreateUserEx()`, it is possible to pass a pointer to a pre-allocated buffer area which will be used to hold the cache data.

```
static U16 _aCache[LCD_XSIZE * LCD_YSIZE];

GUI_GCACHE_CreateUserEx(GUI_GCACHE_16, GUICC_M565, 0, &_aCache[0]);
```

## Limitations

There are some limitations around the bit depths of the `GUI_GCACHE` and the underlying LCD driver.

- The `GUI_GCACHE` cannot be used in 16bpp mode with LCDs that have a bigger bit depth than 16bpp themselves.
- The bit depth of the LCD must not be smaller than the bit depth of the `GUI_GCACHE`.

### 3.6.2.1 GUI\_GCACHE API

#### Functions

Routine	Description
<code>GUI_GCACHE_Create()</code>	Enables a global display cache that works with the given color depth and color conversion.
<code>GUI_GCACHE_CreateEx()</code>	Enables a global display cache that works with the given color depth and color conversion for the given layer.
<code>GUI_GCACHE_CreateUserEx()</code>	Enables a global display cache which works with the selected color depth for the given layer with a user-supplied pointer to the cache memory block.

#### Defines

Group of defines	Description
<code>GUI_GCACHE modes</code>	Available color depths for <code>GUI_GCACHE</code> .

### 3.6.2.1.1 GUI\_GCACHE\_Create()

#### Description

Enables a global display cache that works with the given color depth and color conversion.

#### Prototype

```
int GUI_GCACHE_Create(      int          ( *pfMode)(GUI_DEVICE * ),
                          const LCD_API_COLOR_CONV * pColorConvAPI);
```

#### Parameters

Parameter	Description
<code>pfMode</code>	<b>in</b> One of the modes listed under <i>GUI_GCACHE modes</i> on page 145.
<code>pColorConvAPI</code>	<b>in</b> Color conversion to be used for the cache.

#### Return value

0        on success  
1        on error.

#### Additional information

For additional information see `GUI_GCACHE_CreateUserEx()`.

### 3.6.2.1.2 GUI\_GCACHE\_CreateEx()

#### Description

Enables a global display cache that works with the given color depth and color conversion for the given layer.

#### Prototype

```
int GUI_GCACHE_CreateEx(    int                ( *pfMode)(GUI_DEVICE * ),
                          const LCD_API_COLOR_CONV * pColorConvAPI,
                          int                LayerIndex);
```

#### Parameters

Parameter	Description
<code>pfMode</code>	<b>in</b> One of the modes listed under <i>GUI_GCACHE modes</i> on page 145.
<code>pColorConvAPI</code>	<b>in</b> Color conversion to be used for the cache.
<code>LayerIndex</code>	Layer index to be used.

#### Return value

0        on success  
1        on error.

#### Additional information

For additional information see `GUI_GCACHE_CreateUserEx()`.

### 3.6.2.1.3 GUI\_GCACHE\_CreateUserEx()

#### Description

Enables a global display cache which works with the selected color depth for the given layer with a user-supplied pointer to the cache memory block.

#### Prototype

```
int GUI_GCACHE_CreateUserEx(    int                ( *pfMode)(GUI_DEVICE * ),
                               const LCD_API_COLOR_CONV * pColorConvAPI,
                               int                LayerIndex,
                               void                * pUserBuffer);
```

#### Parameters

Parameter	Description
<code>pfMode</code>	<b>in</b> One of the modes listed under <i>GUI_GCACHE modes</i> on page 145.
<code>pColorConvAPI</code>	<b>in</b> Color conversion to be used for the cache. Can be <code>NULL</code> to use the same color conversion as the display driver.
<code>LayerIndex</code>	Layer index to be used.
<code>pUserBuffer</code>	<b>in</b> Pointer to user-allocated buffer for the cache.

#### Return value

0        on success  
1        on error.

#### Additional information

Once enabled only the colors of the given color conversion can be used. Reading operations or XOR-operations will use the content of the cache.

Note that the bits per pixel specified with `pfMode` need to match the bits per pixel of the given color conversion `pColorConvAPI`.

The pointer passed to `pUserBuffer` has to be large enough to support the dimensions of the LCD:

$$\text{LCD xSize} * \text{LCD ySize} * \text{bits per pixel of } pColorConvAPI$$



### 3.6.2.1.4 GUI\_GCACHE modes

#### Description

GUI\_GCACHE bit depths to be used for GUI\_GCACHE\_Create() and the other creation functions.

#### Definition

```
#define GUI_GCACHE_1      (&GUI_GCACHE_SetMode1bpp)  
#define GUI_GCACHE_4      (&GUI_GCACHE_SetMode4bpp)  
#define GUI_GCACHE_16     (&GUI_GCACHE_SetMode16bpp)
```

#### Symbols

Definition	Description
<a href="#">GUI_GCACHE_1</a>	Use global cache with 1bpp color depth.
<a href="#">GUI_GCACHE_4</a>	Use global cache with 4bpp color depth.
<a href="#">GUI_GCACHE_16</a>	Use global cache with 16bpp color depth.

## 3.7 Framebuffer located in data cache area of CPU

If available it makes sense to enable a data cache on CPU side. That normally speeds up RAM access performance a lot. When using a direct addressable frame buffer (normally managed by `GUIDRV_Lin`) and if the frame buffer of the LCD-controller is located within a cached data memory area, it could happen, that the display shows some disturbance like shown on the screenshot to the right. Please note that this is not a malfunction of emWin. It is caused by the data cache of the CPU. The display driver (normally `GUIDRV_Lin`) writes into memory which is managed by the CPU's data cache. But unfortunately not all data is written directly into the RAM area of the frame buffer, but only into the data cache. In that case the LCD-controller does not have the correct data for generating the display signals. The following explains how to avoid that disturbance.

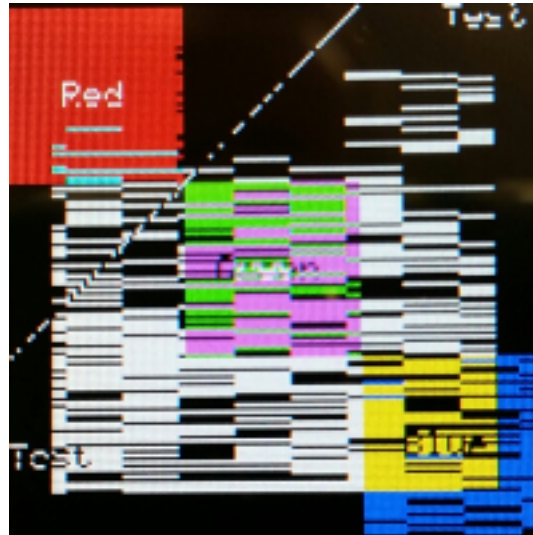

### 3.7.1 Requirements

To be able to use a data cache, it is required that either the cache could be configured to work in 'write-through' mode (please also refer to `GUIDRV_Lin` on page 3314) or multiple buffers should be used (please also refer to *Multiple Buffering* on page 869). If a 'write-through' mode is available, nothing else needs to be considered.

### 3.7.2 Using multiple buffers and a data cache

If the cache is not configurable, multiple buffering must be enabled and a cache clearance function should be set with `GUI_DCACHE_SetClearCacheHook()`.

#### 3.7.2.1 How it works

To be able to see always a screen without cache disturbance, it is required that emWin makes sure, the cache is cleared before the frame buffer becomes visible. That is done by calling the cache clearance function immediately before the back buffer becomes visible. In detail it is called immediately before the display driver callback function gets the command `LCD_X_SHOWBUFFER`.

#### When using the Window Manager

To make sure that all drawing operations are done automatically within the back buffer, the application should not draw anything outside the `WM_PAINT` event of the window manager.

#### 3.7.2.2 Animations and multiple buffering

The most recommended way to use animation functions is animating window content and invalidating the according windows within the animations. That makes sure, multi buffering is used automatically after enabled by `WM_MULTIBUF_Enable()`. If the window manager

is not available or when drawing with animations besides the Window Manager, a slice callback function using `GUI_MULTIBUF_Begin()` and `GUI_MULTIBUF_End()` should be used to make sure the DCache gets cleared. Please also refer to *Using a slice callback function* on page 756.

### 3.7.2.3 Memory device animation functions

#### Note

The following applies to functions listed in the following chapters:

- *Animation functions* on page 2981
- *Animation functions (Window Manager required)* on page 2985
- *Blending, Blurring and Dithering functions* on page 2990
- *Blending and Blurring functions (Window Manager required)* on page 2998

Normally those functions do not use multiple buffering. But in case of using a data cache, multiple buffering is required because all drawing operations need to be done within the back buffer before the cache is cleared and the back buffer becomes visible. For that case the function `GUI_MEMDEV_MULTIBUF_Enable()` should be used to enable that feature.

### 3.7.3 Available API functions

The following functions are available:

Routine	Description
<code>GUI_DCACHE_Clear()</code>	Calls the hook function set with <code>GUI_DCACHE_SetClearCacheHook()</code> .
<code>GUI_DCACHE_SetClearCacheHook()</code>	Sets up a function for clearing the cache of the given layer.

### 3.7.3.1 GUI\_DCACHE\_Clear()

#### Description

Calls the hook function set with `GUI_DCACHE_SetClearCacheHook()`. Normally this function does not need to be called. It should be called automatically by emWin.

#### Prototype

```
void GUI_DCACHE_Clear(U32 LayerMask);
```

#### Parameters

Parameter	Description
<code>LayerMask</code>	Bit mask of layers to be cleared.

#### Additional information

Please refer to `GUI_DCACHE_SetClearCacheHook()`.

### 3.7.3.2 GUI\_DCACHE\_SetClearCacheHook()

#### Description

Sets up a function for clearing the cache of the given layer. That function is called immediately before a back buffer should become visible. That makes sure, no cache disturbance will be visible on the screen.

#### Prototype

```
void GUI_DCACHE_SetClearCacheHook(void ( *pFunc)(U32 LayerMask ));
```

#### Parameters

Parameter	Description
<code>pFunc</code>	Pointer to the function to be used.

#### Additional information

Parameter `LayerMask` passed to the hook function contains a bit mask of the layer(s) to be managed. The number of the bit represents the number of the layer. If for example the data cache of layer 2 should be cleared, bit 2 of the layer mask is set.

#### Example

The following shows a sample implementation of a clear cache function:

```
static void _ClearCacheHook(U32 LayerMask) {
    int i;
    for (i = 0; i < GUI_NUM_LAYERS; i++) {
        if (LayerMask & (1 << i)) {
            _CleanRange(_apVRAM[i], WIDTH * HEIGHT * NUM_BUFFERS * sizeof(U32));
        }
    }
}
```

## 3.8 Hardware acceleration

If a CPU or an LCD-controller offers hardware acceleration features some or even most of them could be used by emWin for accelerating the process of drawing operations. To be able to achieve that, different mechanisms need to be used dependent on the kind of hardware acceleration which should be used.

The following table shows a rough classification of the features which can be accelerated:

Group	Purpose
Color conversion	Some hardware like ChromART offers the possibility of converting colors from one format to a different format. For that many of the color conversion routines offers the possibility to set a hardware function for the process of color conversion.
Drawing of primitives	Hardware accelerated drawing of primitives (also anti-aliased) could be achieved by calling primitive specific setters for passing custom defined functions to be used for drawing.
Filling, copy operations and bitmap drawing	Those operations could be accelerated by setting custom drawing functions using <code>LCD_SetDevFunc()</code> .
Alpha blending	A custom function could be used to mix up the given foreground and background colors in accordance to the alpha values of the colors.
Mixing colors	A custom function could be used to mix up the given foreground and background colors with the given intensity.
Alpha text drawing	Drawing of anti-aliased text could be achieved by setting a custom function.
Palette conversion	Conversion of bitmap palettes could be done by a custom function.
Drawing bitmaps within memory devices	Some internal memory device operations could be accelerated by setting a custom function.
Memory device manipulation	Manipulation of the contents of a memory device such as rotating, scaling or blending.
Drawing of SVGs	The hardware accelerator is based on 2D vector operations which allows the rendering of vector paths which are crucial to the SVG file format.

### 3.8.1 Ready to use configurations

The following table shows some of the hardware accelerators which can be used with ready-to-use sample configurations that come with emWin. These sample configurations set up emWin to use most of the features of the hardware accelerators. They can be used on appropriate hardware with little or no modification:

Hardware	Supported features
Renesas D/AVE 2D hardware IP core	<ul style="list-style-type: none"> <li>• Clipping</li> <li>• Drawing of anti-aliased primitives</li> <li>• Drawing of bitmaps (8-, 16- and 32 bpp)</li> <li>• Filling operations</li> <li>• Rectangle filling with alpha blending</li> <li>• Drawing of anti-aliased text</li> </ul>
STM32 ChromART Accelerator	<ul style="list-style-type: none"> <li>• Color conversion</li> <li>• Drawing of bitmaps (8-, 16- and 32bpp)</li> <li>• Filling operations</li> <li>• Rectangle filling with alpha blending (only supported by some devices, for example by STM32L4R9I)</li> <li>• Drawing of anti-aliased text</li> <li>• Rectangular copy operations</li> </ul>
NXP Pixel Pipeline	<ul style="list-style-type: none"> <li>• Color conversion</li> <li>• Drawing of 16 bpp and 32 bpp bitmaps and memory devices</li> </ul>

Hardware	Supported features
	<ul style="list-style-type: none"> <li>• Rectangle filling with alpha blending</li> <li>• Bulk color mixing</li> <li>• Rectangular copy operations</li> <li>• Color blending of memory devices</li> <li>• Scaling and flipping of bitmaps (opaque bitmaps only)</li> </ul>
Vivante VGLite	<ul style="list-style-type: none"> <li>• Drawing of anti-aliased and non-anti-aliased primitives</li> <li>• Filling of anti-aliased and non-anti-aliased primitives</li> <li>• Scaling and rotation of memory devices</li> <li>• Scaling and flipping of bitmaps (with or without transparency)</li> <li>• Rendering of SVGs</li> <li>• Clipping</li> </ul>
ThinkSilicon NemaVG / NemaGFX STM32 NeoChrom Accelerator	<ul style="list-style-type: none"> <li>• Drawing of anti-aliased and non-anti-aliased primitives</li> <li>• Filling of anti-aliased and non-anti-aliased primitives</li> <li>• %</li> <li>• Scaling and rotation of memory devices</li> <li>• Scaling of bitmaps (with or without transparency)</li> <li>• Rendering of SVGs</li> <li>• Clipping</li> </ul>

Please note that the absence of an accelerator in the above table does not mean that it is not supported by emWin. It does only mean that we do not have ready to use configuration files for it.

### 3.8.2 Using D/AVE 2D hardware IP core

A useful feature of D/AVE 2D hardware IP core is the ability to support a clipping rectangle. Furthermore, it offers a dedicated hardware module for performing anti-aliased drawing operations for anti-aliased shapes. Performing these operations by software requires a lot of CPU time. emWin offers an interface to route these operations to the D/AVE 2D hardware. That makes it ideal for very fast drawing of complex screens with anti-aliased shapes. Also, it is able to fill rectangular areas with a semi-transparent color which can be used for e.g. dimming screen areas. Configuration files can be found under `Sample\LCDConf\GUIDRV_Lin\RX65N` and `Sample\LCDConf\GUIDRV_Lin\EK_RA6M3G`.

### 3.8.3 Using ChromART accelerator

Nearly all functions provided by the ChromART accelerator can be used with emWin. Once configured correctly, it speeds up many drawing operations drastically. The sample folder of emWin contains configuration files which use almost all features of ChromART accelerator which can be found under `Sample\LCDConf\GUIDRV_Lin\STM32xxx`. Please note that the samples are only available if the driver `GUIDRV_Lin` is licensed.

The ChromART accelerators on ST devices are not all identical, e.g. the STM32L4R9I is able to fill rectangular areas with semitransparent colors, but this function is not provided by ChromART on some other ST devices. To take these differences into account, a separate configuration can be found under `Sample\LCDConf\GUIDRV_Lin\STM32L4R9I`.

### 3.8.4 Using NXP Pixel Pipeline

The main feature of the Pixel Pipeline which is alpha composition offers a versatile way of speeding up many intensive operations in emWin. Some of these operations are alpha blending, color mixing and the drawing of bitmaps and memory devices with any opacity.

Filling opaque and semi-transparent rectangles is also supported by the PXP.

Additionally, the PXP offers a scaling and flipping feature which is utilized for speeding up these operations with `GUI_DrawBitmapEx()`.

### 3.8.5 Using Vivante VGLite

The VGLite API is a vector-based hardware drawing API. Through the use of vector paths, virtually any 2D primitive can be drawn. Primitives may be drawn anti-aliased or non-anti-aliased. Since vector paths support floating point coordinates, the use of high-resolution anti-aliasing coordinates is also supported. Furthermore, a clipping rectangle is supported as well.

VGLite also provides blitting API functions that can be used in conjunction with matrix transformations. This allows efficient rotation and scaling of memory devices or raster images. The advantage here over e.g. the PXP accelerator is that the rotation angle is not limited to 90° increments and the bitmap or memory device content may also be semi-transparent.

#### Byte alignments for blitting operations

**Note:** Blitting operations using the VGLite API always require a specific byte alignment of the bitmap data, depending on the format. For example, 32bpp bitmaps require an alignment of 64 bytes.

As for emWin operations delegated to VGLite, currently this only affects the functionality of rotating and scaling memory devices. This means to utilize hardware acceleration for this operation, the horizontal and vertical dimensions of the memory device have to be divisible by 16, to account for the 64-byte alignment.

Obvious workarounds for this limitation would be to crop the memory device content to a size that is divisible by 16. Or alternatively, increase the size so that it is divisible by 16 and fill the padding area with a background color or transparency.

#### Requirement of an operating system

VGLite requires high-level features of an embedded operating system, such as mutexes, semaphores, tasks and queues. This makes it mandatory to provide an interface to an operating system.

An interface to SEGGER embOS is implemented in the file `vg_lite_os_embOS.c`. We encourage to use it, but it may also be taken as a reference point to adapt the interface to another operating system.

### 3.8.6 Available API functions

The following table shows the available routines:

Routine	Description
Color conversion	
<a href="#">GUICC_M1555I_SetCustColorConv()</a> <a href="#">GUICC_M565_SetCustColorConv()</a> <a href="#">GUICC_M4444I_SetCustColorConv()</a> <a href="#">GUICC_M888_SetCustColorConv()</a> <a href="#">GUICC_M8888I_SetCustColorConv()</a>	Setting up custom color conversion routines for the according fixed palette modes.
Filling, copy operations and bitmap drawing	
<a href="#">LCD_SetDevFunc()</a>	The function sets additional and / or user defined functions of the display driver.
<a href="#">GUI_SetFuncDrawM565()</a>	Sets two custom routines for drawing M565 images.
Alpha blending	
<a href="#">GUI_AlphaEnableFillRectHW()</a>	Enables filling a rectangle with a semi-transparent color.
<a href="#">GUI_SetFuncAlphaBlending()</a>	Setting up a custom defined function for doing alpha blending operations.



Routine	Description
<code>GUI_SetFuncDrawAlpha()</code>	Sets two custom routines for drawing memory devices with alpha value into another memory device and for drawing a bitmap with alpha value.
<code>GUI_SetFuncDrawA8()</code>	Sets two custom routines for drawing A8 images.
Mixing colors	
<code>GUI_SetFuncMixColors()</code>	Setting up a custom defined function for blending a single background color value with the given color using the given intensity.
<code>GUI_SetFuncMixColorsBulk()</code>	Setting up a custom defined function for bulk blending operations.
Alpha text drawing	
<code>GUI_AA_SetpfDrawCharAA4()</code>	Sets up a custom defined function for drawing alpha blending characters with 4 bits per pixel.
Palette conversion	
<code>GUI_SetFuncGetpPalConvTable()</code>	Sets a function pointer to a custom function, which converts an array of colors into an array of index values.
Drawing bitmaps within memory devices	
<code>GUI_MEMDEV_SetDrawMemdev16bppFunc()</code>	Sets a custom function for drawing 16bpp bitmaps within 16bpp memory devices.
Drawing shapes	
<code>GUI_SetFuncFillCircle()</code>	This function sets a function pointer which gets called to fill a circle.
<code>GUI_SetFuncDrawCircle()</code>	This function sets a function pointer which gets called to draw a circle.
<code>GUI_SetFuncFillRoundedRect()</code>	Sets a function pointer to fill a rounded rectangle by hardware.
<code>GUI_SetFuncDrawRoundedRect()</code>	Sets a function pointer to draw a rounded rectangle by hardware.
<code>GUI_SetFuncDrawLine()</code>	This function sets a function pointer which gets called to draw a line.
Drawing anti-aliased shapes	
<code>GUI_AA_SetFuncFillCircle()</code>	This function sets a function pointer which gets called to fill an anti aliased circle.
<code>GUI_AA_SetFuncFillPolygon()</code>	This function sets a function pointer which gets called to fill an anti aliased polygon.
<code>GUI_AA_SetFuncDrawCircle()</code>	This function sets a function pointer which gets called to draw an anti aliased circle.
<code>GUI_AA_SetFuncDrawLine()</code>	This function sets a function pointer which gets called to draw an anti aliased line.
<code>GUI_AA_SetFuncDrawPolyOutline()</code>	This function sets a function pointer which gets called to draw an anti aliased polygon.
<code>GUI_AA_SetFuncDrawArc()</code>	This function sets a function pointer which gets called to draw an anti aliased arc.
Bitmap scaling	

Routine	Description
<code>GUI_SetFuncDrawBitmapEx()</code>	Sets a custom function pointer for <code>GUI_DrawBitmapEx()</code> .
<b>Memory device manipulation</b>	
<code>GUI_MEMDEV_SetRotateFuncLR()</code> <code>GUI_MEMDEV_SetRotateFuncHR()</code>	Setting up a custom routine for rotating and scaling a memory device.
<code>GUI_MEMDEV_SetBlendFunc()</code>	Sets a custom routine for blending a color into a memory device.
<b>JPEG decoding</b>	
<code>GUI_JPEG_SetpfDrawEx()</code>	This function sets a function pointer to be used to decode and draw a JPEG file.

### 3.8.6.1 Color conversion

As explained in detail in *Colors* on page 604, color conversion in emWin is required for converting a color value into an index value and vice versa. That is done by the routines pointed by the fixed palette mode structures. These structures have pointers for converting single items and also for bulk conversion of multiple items. The most important color conversions offers the possibility for setting custom defined routines for bulk conversion.

#### 3.8.6.1.1 GUICC\_M1555I\_SetCustColorConv()

#### 3.8.6.1.2 GUICC\_M565\_SetCustColorConv()

#### 3.8.6.1.3 GUICC\_M4444I\_SetCustColorConv()

#### 3.8.6.1.4 GUICC\_M888\_SetCustColorConv()

#### 3.8.6.1.5 GUICC\_M8888I\_SetCustColorConv()

#### Description

These routines can be used to set custom routines for bulk color conversion for the according color conversion.

#### Prototype

```
void GUICC_XXX_SetCustColorConv(tLCDDEV_Color2IndexBulk * pfColor2IndexBulk,
                                tLCDDEV_Index2ColorBulk * pfIndex2ColorBulk);
```

#### Parameters

Parameter	Description
<code>pfColor2IndexBulk</code>	Routine to be used for converting multiple colors into index values.
<code>pfIndex2ColorBulk</code>	Routine to be used for converting multiple index values into colors.

#### Additional information

The definition of `tLCDDEV_Color2IndexBulk` is as follows:

```
typedef void tLCDDEV_Color2IndexBulk(LCD_COLOR * pColor,
                                     void * pIndex,
                                     U32 NumItems,
                                     U8 SizeOfIndex);
```

The definition of `tLCDDEV_Index2ColorBulk` is as follows:

```
typedef void tLCDDEV_Index2ColorBulk(void * pIndex,
                                     LCD_COLOR * pColor,
                                     U32 NumItems,
                                     U8 SizeOfIndex);
```

### 3.8.6.2 Filling, copy operations and bitmap drawing

As already explained before the function `LCD_SetDevFunc` on page 3455 can be used for a couple of cases. Further the following function(s) exist:

#### 3.8.6.2.1 GUI\_SetFuncDrawM565()

##### Description

Sets two custom routines for drawing M565 images. One for drawing into memory devices and a second one for drawing into the frame buffer.

##### Prototype

```
int GUI_SetFuncDrawM565(GUI_DRAWMEMDEV_FUNC * pfDrawMemdevFunc,
                       GUI_DRAWBITMAP_FUNC * pfDrawBitmapFunc);
```

##### Parameters

Parameter	Description
<code>pfDrawMemdevFunc</code>	Pointer to a function for drawing M565 images into memory devices.
<code>pfDrawBitmapFunc</code>	Pointer to a function for drawing M565 images into the frame buffer.

##### Additional information

The prototype of the function used for memory devices is:

```
void GUI_DRAWMEMDEV_FUNC ( void * pDst,
                           const void * pSrc,
                           int xSize,
                           int ySize,
                           int BytesPerLineDst,
                           int BytesPerLineSrc);
```

The prototype of the function used for bitmaps is:

```
void GUI_DRAWBITMAP_FUNC (int LayerIndex,
                          int x,
                          int y,
                          U32 const * p,
                          int xSize,
                          int ySize,
                          int BytesPerLine);
```

This hardware acceleration functions are used for drawing high color bitmaps in M565 format.

### 3.8.6.3 Alpha blending

#### 3.8.6.3.1 GUI\_AlphaEnableFillRectHW()

##### Description

Enables filling a rectangle with a semi-transparent color.

##### Prototype

```
void GUI_AlphaEnableFillRectHW(int OnOff);
```

##### Parameters

Parameter	Description
OnOff	Turns filling a rectangle with a semi-transparent color on or off.

##### Additional information

This function requires a function for filling a rectangle by the hardware. Please refer to `LCD_SetDevFunc()`.

### 3.8.6.3.2 GUI\_SetFuncAlphaBlending()

#### Description

Sets a custom defined routine for alpha blending operations. That routine is called by emWin if multiple foreground colors should be mixed up with the background.

#### Prototype

```
void ( * GUI_SetFuncAlphaBlending(void ( * pFunc)
                                (LCD_COLOR          * pColorFG,
                                 LCD_COLOR          * pColorBG,
                                 LCD_COLOR          * pColorDst,
                                 U32 NumItems))) (LCD_COLOR * pColorFG,
                                                LCD_COLOR * pColorBG,
                                                LCD_COLOR * pColorDst,
                                                U32          NumItems);
```

#### Parameters

Parameter	Description
<a href="#">pFunc</a>	Pointer to the function to be used.

#### Return value

Pointer to the previous used function.

#### Parameters of pFunc()

Data type	Parameter	Description
LCD_COLOR *	<a href="#">pColorFG</a>	Pointer to the foreground color array.
LCD_COLOR *	<a href="#">pColorBG</a>	Pointer to the background color array.
LCD_COLOR *	<a href="#">pColorDest</a>	Pointer to a buffer for the result.
U32	<a href="#">NumItems</a>	Number of colors to be mixed up.

### 3.8.6.3.3 GUI\_SetFuncDrawAlpha()

#### Description

Sets two custom routines for drawing memory devices with alpha value into another memory device and for drawing a bitmap with alpha value.

#### Prototype

```
int GUI_SetFuncDrawAlpha(GUI_DRAWMEMDEV_FUNC * pfDrawAlphaMemdevFunc,
                        GUI_DRAWBITMAP_FUNC * pfDrawAlphaBitmapFunc);
```

#### Parameters

Parameter	Description
<a href="#">pfDrawAlphaMemdevFunc</a>	Pointer to a function for drawing bitmaps in memory devices.
<a href="#">pfDrawAlphaBitmapFunc</a>	Pointer to a function for drawing bitmaps in frame buffer.

#### Additional information

The prototype of the function used for memory devices is:

```
void GUI_DRAWMEMDEV_FUNC (    void * pDst,
                             const void * pSrc,
                             int    xSize,
                             int    ySize,
                             int    BytesPerLineDst,
                             int    BytesPerLineSrc);
```

The prototype of the function used for bitmaps is:

```
void GUI_DRAWBITMAP32_FUNC (int    LayerIndex,
                            int    x,
                            int    y,
                            U32 const * p,
                            int    xSize,
                            int    ySize,
                            int    BytesPerLine);
```

This hardware acceleration functions are used for drawing 32 bpp alpha bitmaps.

### 3.8.6.3.4 GUI\_SetFuncDrawA8()

#### Description

Sets two custom routines for drawing A8 images. One for drawing into memory devices and a second one for drawing into the frame buffer.

#### Prototype

```
int GUI_SetFuncDrawA8(GUI_DRAWMEMDEV_FUNC * pfDrawMemdevFunc,
                     GUI_DRAWBITMAP_FUNC * pfDrawBitmapFunc);
```

#### Parameters

Parameter	Description
<code>pfDrawMemdevFunc</code>	Pointer to a function for drawing A8 images into memory devices.
<code>pfDrawBitmapFunc</code>	Pointer to a function for drawing A8 images into the frame buffer.

#### Additional information

The prototype of the function used for memory devices is:

```
void GUI_DRAWMEMDEV_FUNC (    void * pDst,
                             const void * pSrc,
                             int    xSize,
                             int    ySize,
                             int    BytesPerLineDst,
                             int    BytesPerLineSrc);
```

The prototype of the function used for bitmaps is:

```
void GUI_DRAWBITMAP_FUNC (int    LayerIndex,
                          int    x,
                          int    y,
                          U32 const * p,
                          int    xSize,
                          int    ySize,
                          int    BytesPerLine);
```

This hardware acceleration functions are used for drawing antialiased TTF-fonts and non compressed 8 bit alpha bitmaps containing alpha channel only.



### 3.8.6.4 Mixing colors

Mixing up colors here means mixing up the given background with the given foreground using the given intensity.

#### 3.8.6.4.1 GUI\_SetFuncMixColors()

##### Description

Sets a custom defined routine for mixing up single colors.

##### Prototype

```
LCD_COLOR ( * GUI_SetFuncMixColors(LCD_COLOR ( * pFunc)
                                         (LCD_COLOR          Color,
                                          LCD_COLOR          BkColor,
                                           U8 Intens))) (LCD_COLOR Color,
                                                         LCD_COLOR BkColor,
                                                         U8          Intens);
```

##### Parameters

Parameter	Description
<code>pFunc</code>	Pointer to the function to be used.

##### Parameters of pFunc()

Data type	Parameter	Description
LCD_COLOR	<code>Color</code>	Color to be blended with the given intensity.
LCD_COLOR	<code>BkColor</code>	Color of background.
U8	<code>Intens</code>	Intensity to be used for the blending operation.

### 3.8.6.4.2 GUI\_SetFuncMixColorsBulk()

#### Description

Sets up a custom defined function for bulk mixing operations. That is mainly used for fading memory devices. It mixes up the given background area with the given foreground area using the desired intensity.

#### Prototype

```
void ( * GUI_SetFuncMixColorsBulk(void ( * pFunc)(U32          * pFG,
                                                U32          * pBG,
                                                U32          * pDst,
                                                unsigned      OffFG,
                                                unsigned      OffBG,
                                                unsigned      OffDest,
                                                unsigned      xSize,
                                                unsigned      ySize,
                                                U8 Intens))) (U32 * pFG,
                                                           U32 * pBG,
                                                           U32 * pDst,
                                                           unsigned OffFG,
                                                           unsigned OffBG,
                                                           unsigned OffDest,
                                                           unsigned xSize,
                                                           unsigned ySize,
                                                           U8 Intens);
```

#### Parameters

Parameter	Description
<code>pFunc</code>	Pointer to the function to be used.

#### Parameters of pFunc()

Data type	Parameter	Description
U32 *	<code>pFG</code>	Pointer to the foreground color array.
U32 *	<code>pBG</code>	Pointer to the background color array.
U32 *	<code>pDst</code>	Pointer to the destination buffer for the result.
unsigned	<code>OffFG</code>	<i>Currently not used.</i>
unsigned	<code>OffBG</code>	Additional offset in pixels ( <code>xSizeBG - xSizeFG</code> ) to be added for incrementing the background pointer at the end of a line.
unsigned	<code>OffDest</code>	<i>Currently not used.</i>
unsigned	<code>xSize</code>	X-size of area to be converted.
unsigned	<code>ySize</code>	Y-size of area to be converted.
U8	<code>Intens</code>	Intensity to be used when blending the foreground over the background.

#### Return value

Pointer to the previous used function.

### 3.8.6.5 Alpha text drawing

If transparent mode is active, no memory device is selected and no clipping is required a custom function could be used for drawing anti-aliased characters. In all other cases automatically the default function is used by emWin. Alpha text drawing means that the given character image consists of intensity values which need to be used to mix up the current background with the current foreground color.

#### 3.8.6.5.1 GUI\_AA\_SetpfDrawCharAA4()

##### Description

Sets up a custom defined function for drawing alpha blending characters with 4 bits per pixel. The intensities to be used are stored in a byte array passed to the function. Each pixel is stored in one nibble. The leftmost pixel is stored in the uppermost nibble.

##### Prototype

```
void GUI_AA_SetpfDrawCharAA4
    (int ( *pfDrawChar)
    (int LayerIndex , int x , int y , U8 const * p , int xSize , int ySize , int BytesPerLine ));
```

##### Parameters

Parameter	Description
<code>pfDrawChar</code>	Pointer to the function to be used.

##### Parameters of pfDrawChar()

Data type	Parameter	Description
int	<code>LayerIndex</code>	Destination layer of drawing operation.
int	<code>xPos</code>	X-Position in screen coordinates to be used.
int	<code>yPos</code>	Y-Position in screen coordinates to be used.
const U8 *	<code>p</code>	Pointer to an array of bytes containing the intensity values to be used.
int	<code>xSize</code>	X-size of character to be drawn.
int	<code>ySize</code>	Y-size of character to be drawn.
int	<code>BytesPerLine</code>	Bytes per line of the intensity array.

### 3.8.6.6 Palette conversion

Palettes need to be converted when drawing device independent bitmaps with a color depth of 8 bits per pixel or less. The conversion routine converts the colors of the bitmap palette into index values to be used for drawing into the frame buffer. For that conversion process, normally done by emWin, a custom function can be set.

#### 3.8.6.6.1 GUI\_SetFuncGetpPalConvTable()

##### Description

Sets a function pointer to a custom function, which converts an array of colors into an array of index values. It should return a pointer to the first entry of the index table.

##### Prototype

```
void GUI_SetFuncGetpPalConvTable
    (LCD_PIXELINDEX * ( *pFunc)
 (const LCD_LOGPALETTE * pLogPal , const GUI_BITMAP * pBitmap , int LayerIndex ));
```

##### Parameters

Parameter	Description
<code>pFunc</code>	Pointer to the function to be used.

##### Parameters of pfFunc()

Data type	Parameter	Description
<code>const LCD_LOGPALETTE *</code>	<code>pLogPal</code>	Pointer to the array of colors to be converted.
<code>const GUI_BITMAP *</code>	<code>pBitmap</code>	Pointer to the bitmap to be drawn.
<code>int</code>	<code>LayerIndex</code>	Layer index of drawing operation.

##### Elements of structure LCD\_LOGPALETTE

Data type	Element	Description
<code>int</code>	<code>NumEntries</code>	Number of color values located in the palette.
<code>char</code>	<code>HasTrans</code>	0 - No transparency should be used. 1 - Pixels with index 0 are treated as transparent.
<code>const LCD_COLOR *</code>	<code>pPalEntries</code>	Pointer to the array of color values.

##### Return value

A pointer to the array of index values of type `LCD_PIXELINDEX`.

##### Additional information

The process of drawing a bitmap within emWin and the mechanism of color conversion should be well known when using that function.

### 3.8.6.7 Drawing bitmaps within memory devices

A custom function for drawing bitmaps with a color depth of 16bpp into memory devices with a color depth of 16bpp can be used. The task of that function is copying the data of the bitmap to be drawn into the destination memory device.

#### 3.8.6.7.1 GUI\_MEMDEV\_SetDrawMemdev16bppFunc()

##### Description

Sets a custom function for drawing 16bpp bitmaps within 16bpp memory devices.

##### Prototype

```
void GUI_MEMDEV_SetDrawMemdev16bppFunc
    (GUI_DRAWMEMDEV_16BPP_FUNC * pfDrawMemdev16bppFunc);
```

##### Parameters

Parameter	Description
<code>pfDrawMemdev16bppFunc</code>	Pointer to the function to be used.

##### Additional information

The definition of `GUI_DRAWMEMDEV_16BPP_FUNC` is as follows:

```
typedef void GUI_DRAWMEMDEV_16BPP_FUNC (
    void * pDst,
    const void * pSrc,
    int xSize,
    int ySize,
    int BytesPerLineDst,
    int BytesPerLineSrc);
```

##### Parameters of GUI\_DRAWMEMDEV\_16BPP\_FUNC

Data type	Parameter	Description
<code>void *</code>	<code>pDst</code>	Destination pointer for upper left pixel to be drawn.
<code>const void *</code>	<code>pSrc</code>	Source pointer for upper left pixel to be drawn.
<code>int</code>	<code>xSize</code>	X-size in pixels of area to be drawn.
<code>int</code>	<code>ySize</code>	Y-size in pixels of area to be drawn.
<code>int</code>	<code>BytesPerLineDst</code>	Stride value in bytes of destination area.
<code>int</code>	<code>BytesPerLineSrc</code>	Stride value in bytes of source bitmap.

## 3.8.6.8 Drawing shapes

### 3.8.6.8.1 GUI\_SetFuncFillCircle()

#### Description

This function sets a function pointer which gets called to fill a circle.

#### Prototype

```
void GUI_SetFuncFillCircle(int ( *pfFillCircle)(int x0 , int y0 , int r ));
```

#### Parameters

Parameter	Description
<code>pfFillCircle</code>	Function pointer to a function for filling a circle.

#### Parameters of pfFillCircle()

Data type	Parameter	Description
int	<code>x0</code>	x position of the center of the circle.
int	<code>y0</code>	y position of the center of the circle.
int	<code>r</code>	Radius of the circle.

### 3.8.6.8.2 GUI\_SetFuncDrawCircle()

#### Description

This function sets a function pointer which gets called to draw a circle.

#### Prototype

```
void GUI_SetFuncDrawCircle(int (*pfDrawCircle)(int x0 , int y0 , int r ));
```

#### Parameters

Parameter	Description
<code>pfDrawCircle</code>	Function pointer to a function for drawing a circle.

#### Parameters of pfDrawCircle()

Data type	Parameter	Description
int	<code>x0</code>	x position of the center of the circle.
int	<code>y0</code>	y position of the center of the circle.
int	<code>r</code>	Radius of the circle.

### 3.8.6.8.3 GUI\_SetFuncFillRoundedRect()

#### Description

Sets a function pointer to fill a rounded rectangle by hardware.

#### Prototype

```
void GUI_SetFuncFillRoundedRect
    (int (*pfFillRoundedRect)(int x0 , int y0 , int x1 , int y1 , int r ));
```

#### Parameters

Parameter	Description
<code>pfFillRoundedRect</code>	Pointer to the function to be called.

#### Parameters of pfFillRoundedRect()

Data type	Parameter	Description
int	<code>x0</code>	Upper left X-position.
int	<code>y0</code>	Upper left Y-position.
int	<code>x1</code>	Lower right X-position.
int	<code>y1</code>	Lower right Y-position.
int	<code>r</code>	Radius in pixels to be used.



### 3.8.6.8.4 GUI\_SetFuncDrawRoundedRect()

#### Description

Sets a function pointer to draw a rounded rectangle by hardware.

#### Prototype

```
void GUI_SetFuncDrawRoundedRect
    (int (*pfDrawRoundedRect)(int x0 , int y0 , int x1 , int y1 , int r ));
```

#### Parameters

Parameter	Description
<code>pfDrawRoundedRect</code>	Pointer to the function to be called.

#### Parameters of pfDrawRoundedRect()

Data type	Parameter	Description
int	<code>x0</code>	Upper left X-position.
int	<code>y0</code>	Upper left Y-position.
int	<code>x1</code>	Lower right X-position.
int	<code>y1</code>	Lower right Y-position.
int	<code>r</code>	Radius in pixels to be used.

### 3.8.6.8.5 GUI\_SetFuncDrawLine()

#### Description

This function sets a function pointer which gets called to draw a line.

#### Prototype

```
void GUI_SetFuncDrawLine(int (*pfDrawLine)(int x0 , int y0 , int x1 , int y1 ));
```

#### Parameters

Parameter	Description
<code>pfDrawLine</code>	Function pointer to a function for drawing a line.

#### Parameters of pfDrawLine()

Data type	Parameter	Description
int	x0	Start x position of the line.
int	y0	Start y position of the line.
int	x1	End x position of the line.
int	y1	End y position of the line.

### 3.8.6.9 Drawing anti-aliased shapes

#### 3.8.6.9.1 GUI\_AA\_SetFuncFillCircle()

##### Description

This function sets a function pointer which gets called to fill an anti aliased circle.

##### Prototype

```
void GUI_AA_SetFuncFillCircle(int (*pfFillCircle)(int x0 , int y0 , int r ));
```

##### Parameters

Parameter	Description
<code>pfFillCircle</code>	Function pointer to a function for filling a circle.

##### Parameters of pfFillCircle()

Data type	Parameter	Description
int	<code>x0</code>	x position of the center of the circle.
int	<code>y0</code>	y position of the center of the circle.
int	<code>r</code>	Radius of the circle.

### 3.8.6.9.2 GUI\_AA\_SetFuncFillPolygon()

#### Description

This function sets a function pointer which gets called to fill an anti aliased polygon.

#### Prototype

```
void GUI_AA_SetFuncFillPolygon
    (int ( *pfFillPolygon)
    (const GUI_POINT * pPoints , int NumPoints , int x0 , int y0 ));
```

#### Parameters

Parameter	Description
<code>pfFillPolygon</code>	Function pointer to a function for filling a polygon.

#### Parameters of pfFillPolygon()

Data type	Parameter	Description
<code>GUI_POINT *</code>	<code>pPoints</code>	Pointer to a list of points.
<code>int</code>	<code>NumPoints</code>	Number of elements of <code>pPoints</code> .
<code>int</code>	<code>x0</code>	x position of the start of the polygon.
<code>int</code>	<code>y0</code>	y position of the start of the polygon.

### 3.8.6.9.3 GUI\_AA\_SetFuncDrawCircle()

#### Description

This function sets a function pointer which gets called to draw an anti aliased circle.

#### Prototype

```
void GUI_AA_SetFuncDrawCircle(int (*pfDrawCircle)(int x0 , int y0 , int r ));
```

#### Parameters

Parameter	Description
<code>pfDrawCircle</code>	Function pointer to a function for drawing a circle.

#### Parameters of pfDrawCircle()

Data type	Parameter	Description
int	<code>x0</code>	x position of the center of the circle.
int	<code>y0</code>	y position of the center of the circle.
int	<code>r</code>	Radius of the circle.

### 3.8.6.9.4 GUI\_AA\_SetFuncDrawLine()

#### Description

This function sets a function pointer which gets called to draw an anti aliased line.

#### Prototype

```
void GUI_AA_SetFuncDrawLine
    (int ( *pfDrawLine)(int x0 , int y0 , int x1 , int y1 ));
```

#### Parameters

Parameter	Description
<code>pfDrawLine</code>	Function pointer to a function for drawing a line.

#### Parameters of pfDrawLine()

Data type	Parameter	Description
<code>int</code>	<code>x0</code>	Start x position of the line.
<code>int</code>	<code>y0</code>	Start y position of the line.
<code>int</code>	<code>x1</code>	End x position of the line.
<code>int</code>	<code>y1</code>	End y position of the line.

### 3.8.6.9.5 GUI\_AA\_SetFuncDrawPolyOutline()

#### Description

This function sets a function pointer which gets called to draw an anti aliased polygon.

#### Prototype

```
void GUI_AA_SetFuncDrawPolyOutline
    (int ( *pfDrawPolyOutline)
    (const GUI_POINT * pSrc , int NumPoints , int Thickness , int x , int y ));
```

#### Parameters

Parameter	Description
<code>pfDrawPolyOutline</code>	Function pointer to a function for drawing a polygon.

#### Parameters of pfDrawPolyOutline()

Data type	Parameter	Description
<code>GUI_POINT *</code>	<code>pPoints</code>	Pointer to a list of points.
<code>int</code>	<code>NumPoints</code>	Number of elements of <code>pPoints</code> .
<code>int</code>	<code>Thickness</code>	The thickness of the poly outline.
<code>int</code>	<code>x0</code>	x position of the start of the polygon.
<code>int</code>	<code>y0</code>	y position of the start of the polygon.

### 3.8.6.9.6 GUI\_AA\_SetFuncDrawArc()

#### Description

This function sets a function pointer which gets called to draw an anti aliased arc.

#### Prototype

```
void GUI_AA_SetFuncDrawArc
    (int (*pfDrawArc)(int x0 , int y0 , int rx , int ry , I32 a0 , I32 a1 ));
```

#### Parameters

Parameter	Description
<code>pfDrawArc</code>	Function pointer to a function for drawing an arc.

#### Parameters of pfDrawArc()

Data type	Parameter	Description
int	<code>x0</code>	Center x position of the arc.
int	<code>y0</code>	Center y position of the arc.
int	<code>rx</code>	Radius in x direction.
int	<code>ry</code>	Radius in y direction.
int	<code>a0</code>	Start of the arc in degrees.
int	<code>a1</code>	End of the arc in degrees.



### 3.8.6.10 Bitmap scaling

#### 3.8.6.10.1 GUI\_SetFuncDrawBitmapEx()

##### Description

Sets a custom function pointer for `GUI_DrawBitmapEx()`.

##### Prototype

```
void GUI_SetFuncDrawBitmapEx
    (int ( *pfDrawBitmapEx)
    (const GUI_BITMAP * pBitmap , int x0 , int y0 , int xMag , int yMag ));
```

##### Parameters

Parameter	Description
<code>pfDrawBitmapEx</code>	Function to be set.

##### Additional information

`pfDrawBitmapEx` should return 1 on error and 0 on success.

Note that the parameters `x0` and `y0` of `pFunc` already observe the center position and magnification. This means `x0/y0` is always the upper left position of where the scaled bitmap is drawn on the display.

##### Parameters of `pfDrawBitmapEx()`

Data type	Parameter	Description
<code>const GUI_BITMAP *</code>	<code>pBitmap</code>	Pointer to a <code>GUI_BITMAP</code> structure.
<code>int</code>	<code>x0</code>	Top-left X position of where the scaled result should be drawn.
<code>int</code>	<code>y0</code>	Top-left Y position of where the scaled result should be drawn.
<code>int</code>	<code>xMag</code>	Scaling factor for X axis in promille (100% = 1000). Negative values means the axis is flipped.
<code>int</code>	<code>yMag</code>	Scaling factor for Y axis in promille (100% = 1000). Negative values means the axis is flipped.

### 3.8.6.11 Memory device manipulation

#### 3.8.6.11.1 GUI\_MEMDEV\_SetRotateFuncLR()

#### 3.8.6.11.2 GUI\_MEMDEV\_SetRotateFuncHR()

##### Description

Sets a custom routine that rotates and scales a memory device by the given parameters. The LR routine receives low resolution coordinates as parameters while the HR routine receives high resolution coordinates (display coordinates multiplied by 8).

##### Prototypes

```
void GUI_MEMDEV_SetRotateFuncLR(int (* pfRotate)(GUI_MEMDEV_Handle hSrc,
                                                GUI_MEMDEV_Handle hDst,
                                                int dx,
                                                int dy,
                                                int a1000,
                                                int Mag));

void GUI_MEMDEV_SetRotateFuncHR(int (* pfRotate)(GUI_MEMDEV_Handle hSrc,
                                                GUI_MEMDEV_Handle hDst,
                                                int dx,
                                                int dy,
                                                int a1000,
                                                int Mag));
```

##### Parameters

Parameter	Description
<code>pFunc</code>	Pointer to the function to be used.

##### Parameters of pFunc()

Data type	Parameter	Description
GUI_MEMDEV_Handle	<code>hSrc</code>	Source memory device.
GUI_MEMDEV_Handle	<code>hDst</code>	Destination memory device.
int	<code>dx</code>	Offset to the X position.
int	<code>dy</code>	Offset to the Y position.
int	<code>a1000</code>	Rotation angle in 1000ths of degrees (1° = 1000).
int	<code>Mag</code>	Scaling factor in promille (100% = 1000).

### 3.8.6.11.3 GUI\_MEMDEV\_SetBlendFunc()

#### Description

Sets a custom routine for blending a color into a memory device.

#### Prototype

```
void GUI_MEMDEV_SetBlendFunc
    (int ( *pfBlend)
    (GUI_MEMDEV_Handle hMem , GUI_COLOR Color , U8 BlendIntens ));
```

#### Parameters

Parameter	Description
<code>pFunc</code>	Pointer to the function to be used.

#### Parameters of pFunc()

Data type	Parameter	Description
GUI_MEMDEV_Handle	<code>hMem</code>	Memory device to be blended.
GUI_COLOR	<code>Color</code>	Blend color to be used.
U8	<code>BlendIntens</code>	Blending intensity for <code>Color</code> .

### 3.8.6.12 JPEG decoding

If the used MCU is capable of decoding JPEG files, emWin offers an interface to reroute the decoding and drawing operations to hardware routines.

This offers a huge performance boost when displaying JPEG files compared to a software only solution. Especially if a movie file should be displayed (.emf or .avi) it makes sense to use the hardware decoder of a MCU.

The interface between emWin and the hardware decoder was developed on a STM32F769 MCU but can be configured to work on other MCUs which come with a hardware JPEG decoder.

#### Using hardware JPEG decoding

Every emWin shipment comes with a sample configuration file which is located under `Sample\JPEGConf\STM32F769`. It requires embOS and the hardware abstraction layer provided by ST because it was made to be used on a STM32F769. Using the hardware decoding functionality is basically achieved by setting a function pointer. This function will manage the process of decoding and drawing. Every time one of the functions `GUI_JPEG_Draw()` or `GUI_JPEG_DrawEx()` are used the set function pointer gets called.

If the function gets called, it is necessary to call the `GetData` function to receive as many bytes as required to start the JPEG decoding process. After receiving the data they get passed to the hardware routines and the decoding process starts. If required the `GetData` function has to be called multiple times until the decoding process has been finished.

After the process of hardware decoding the data needs to be converted from YCbCr format into RGB data. Unfortunately the STM32F769 offers no function to do that conversion per hardware. The `JPEGConf.c` mentioned before is an example on how to do this.

Once the data is completely converted into RGB data it is shown on the display (depending on the currently selected device).

### 3.8.6.12.1 GUI\_JPEG\_SetpfDrawEx()

#### Description

This function sets a function pointer to be used to decode and draw a JPEG file.

#### Prototype

```
void GUI_JPEG_SetpfDrawEx
    (int (*pfDrawEx)
    (GUI_JPEG_GET_DATA_FUNC * pfGetData , void * p , int x0 , int y0 ));
```

#### Parameters

Parameter	Description
<code>pfDrawEx</code>	Pointer to the function to be used.

#### Additional information

If set, the function pointer gets called if `GUI_JPEG_Draw()` or `GUI_JPEG_DrawEx()` gets called. The MOVIE module of emWin makes also use of this function. The function pointer is described below.

#### 3.8.6.12.1.1 pfDrawEx()

#### Description

This function pointer gets called every time a JPEG should be displayed. Within this function data needs to be received by the `GetData` function, the decoding process has to be performed as well as the drawing of the completely decoded JPEG on the display.

#### Prototype

```
int (* pfDrawEx)(GUI_GET_DATA_FUNC * pfGetData,
                void * p,
                int x0,
                int y0);
```

#### Parameters

Parameter	Description
<code>pfGetData</code>	Function pointer to a <code>GetData</code> function
<code>p</code>	Data pointer which is passed to the <code>GetData</code> function.
<code>x0</code>	x position the JPEG file should be displayed.
<code>y0</code>	y position the JPEG file should be displayed.

#### Return value

0        on success.  
1        on error.

#### Additional information

An example of the `GetData` function can be found under *Getting data with the ...Ex() functions* on page . If this function returns 1 the default JPEG drawing routine of emWin gets called.

## 3.9 Memory management

emWin comes with its own memory management system which means the user does not have to allocate and free memory themselves. Because emWin manages the memory itself, it is also easily possible to calculate the memory requirements of an emWin application.

### 3.9.1 Usage

With the function `GUI_ALLOC_AssignMemory()` the user assigns emWin a single, contiguous block of memory which can reside in either internal or external memory. Once this memory block has been assigned to emWin, the user does not have to perform anymore manual memory management regarding emWin routines.

emWin now uses this given memory area for all dynamic memory allocations. Dynamic allocations are used in many places of the emWin API, e.g. Memory Devices, cache for indirect drivers, decompressing image data (e.g. JPEG, PNG) and many more operations.

One important exception is the `GUIDRV_Lin` driver which requires a memory block for the frame buffer provided by the user. emWin does not allocate the memory for the frame buffer.

The assigned memory block is entirely managed by emWin and should not be accessed by the user directly. Otherwise this might lead to unexpected behavior.

### 3.9.2 Block management

Memory in emWin is allocated in blocks. To manage these blocks, a few additional bytes are required for each block. This block overhead is located in its own memory block. Initially, this block is quite small since it only manages a few memory blocks. But this block will increase in size, e.g. when memory for a window application is required.

This overhead memory gets reused when blocks are getting deleted and created again, but it will not get freed by emWin. So this should not be mistaken as a memory leak, this is normal behavior.

### 3.9.3 Available API functions

The following functions allow control of memory usage at runtime. They can be used to e.g. prevent waste of memory.

Routine	Description
<code>GUI_ALLOC_GetMaxUsedBytes()</code>	This function returns the number of the maximum number of used bytes.
<code>GUI_ALLOC_GetNumFreeBytes()</code>	This function returns the number of bytes which can be used for emWin functions.
<code>GUI_ALLOC_GetMemInfo()</code>	This function fills the given info structure with information about the memory usage.
<code>GUI_ALLOC_GetNumUsedBytes()</code>	This function returns the number of bytes which are already used by emWin functions.

### 3.9.3.1 GUI\_ALLOC\_GetMaxUsedBytes()

#### Description

This function returns the number of the maximum number of used bytes. This function is used to get the peak of used bytes.

#### Prototype

```
GUI_ALLOC_DATATYPE GUI_ALLOC_GetMaxUsedBytes(void);
```

#### Return value

Maximum number of used bytes.

### 3.9.3.2 GUI\_ALLOC\_GetNumFreeBytes()

#### Description

This function returns the number of bytes which can be used for emWin functions.

#### Prototype

```
GUI_ALLOC_DATATYPE GUI_ALLOC_GetNumFreeBytes(void);
```

#### Return value

Number of free bytes.



### 3.9.3.3 GUI\_ALLOC\_GetMemInfo()

#### Description

This function fills the given info structure with information about the memory usage.

#### Prototype

```
void GUI_ALLOC_GetMemInfo(GUI_ALLOC_INFO * pInfo);
```

#### Parameters

Parameter	Description
<code>pInfo</code>	Pointer to to a GUI_ALLOC_INFO structure.

#### Elements of structure GUI\_ALLOC\_INFO

Data type	Element	Description
U32	TotalBytes	Total amount of bytes available.
U32	FreeBytes	Number of free bytes.
U32	UsedBytes	Number used bytes.
U32	AllocSize	Number of bytes available for memory management.
U32	NumFixed	Number of fixed bytes.
U32	MaxUsedBytes	The peak of used bytes.

### 3.9.3.4 GUI\_ALLOC\_GetNumUsedBytes()

#### Description

This function returns the number of bytes which are already used by emWin functions.

#### Prototype

```
GUI_ALLOC_DATATYPE GUI_ALLOC_GetNumUsedBytes(void);
```

#### Return value

Number of used bytes.

## 3.10 Hook functions

emWin allows to set hook functions for various purposes, e.g. initialization or management of cache buffers.

Routine	Description
<code>GUI_SetAfterExitHook()</code>	Sets an optional function to be called during the process of deinitialization.
<code>GUI_SetAfterInitHook()</code>	Sets an optional function to be called during the process of initialization.
<code>GUI_SetControlHook()</code>	Sets a function which is called immediately before a display driver cache operation should be executed.
<code>GUI_SetRefreshHook()</code>	Sets a callback function which waits until the vertical non display period has been reached before updating the screen.

### 3.10.0.1 GUI\_SetAfterExitHook()

#### Description

Sets an optional function to be called during the process of deinitialization. It may be used for example to free memory the user has allocated.

#### Prototype

```
void GUI_SetAfterExitHook(void ( *pFunc)());
```

#### Parameters

Parameter	Description
<code>pFunc</code>	Pointer to a function called before <code>GUI_Exit()</code> returns.

### 3.10.0.2 GUI\_SetAfterInitHook()

#### Description

Sets an optional function to be called during the process of initialization. It may be used for example for putting a PID into operation after the GUI has been initialized.

#### Prototype

```
void GUI_SetAfterInitHook(void ( *pFunc)());
```

#### Parameters

Parameter	Description
<code>pFunc</code>	Pointer to a function called immediately before <code>GUI_Init()</code> returns.

#### Additional information

This function should be called before `GUI_Init()` is called.

### 3.10.0.3 GUI\_SetControlHook()

#### Description

Under certain circumstances it could make sense to have a function which is called immediately before a display driver cache operation should be executed. It could be used for example if `GUIDRV_Lin` is used for managing the content of a layer and a custom function should be used for transferring it to the display.

#### Prototype

```
void GUI_SetControlHook(void ( *pFunc)(int LayerIndex , int Cmd ));
```

#### Parameters

Parameter	Description
<code>pFunc</code>	Callback function to be called before a driver cache operation should be executed.

#### Additional information

That function is called independently of the existence of a cache in the driver.

### 3.10.0.4 GUI\_SetRefreshHook()

#### Description

Sets a callback function which waits until the vertical non display period has been reached before updating the screen. Tearing effects could occur if the content of the frame buffer changes during the display controller is not in the vertical non display period and currently updating the screen. A detailed description of tearing effects can be found in the chapter *Multiple Buffering* on page 869. If tearing effects should not occur and the following assumptions are fulfilled that function can be used to avoid those effects:

- Display uses an indirect interface
- Display provides a tearing signal (TE)
- Display communication is fast enough for updating the frame buffer within the vertical non display period. The function sets a callback function which is called immediately before sending any content to the display controller. That gives the application the chance to wait until the display controller is within the vertical non display period. That can be achieved by polling the TE-pin of the display (if available). The function should return immediately after reaching the non display period. After that the driver sends its (dirty) content to the display controller.

#### Prototype

```
void GUI_SetRefreshHook(void ( *pFunc)());
```

#### Parameters

Parameter	Description
<code>pFunc</code>	Callback function to be called before a driver cache operation should be executed.

#### Additional information

When using this function it is important to avoid writing to the display controller for each drawing operation. This can be achieved by the cache locking mechanism. Details can be found in the section *Cache group* on page 3464.

# Chapter 4

## Simulation

---

The PC simulation of emWin allows you to compile the same C source on your Windows PC using a native (typically Microsoft) compiler and create an executable for your own application. Doing so allows the following:

- Design of the user interface on your PC (no hardware required!).
- Debugging of the user interface program.
- Creation of demos of your application, which can be used to discuss the user interface.

The resulting executable can be sent easily via e-mail.





## 4.1 Using the simulation

The emWin simulation requires Microsoft Visual C++ (version 6.00 or higher) and the integrated development environment (IDE) which comes with it. You will see a simulation of your LCD on your PC screen, which has the same resolution in X and Y and can display the exact same colors as your LCD once it has been properly configured. The entire graphic library API and Window Manager API of the simulation are identical to those on your target system; all functions will behave in the very same way as on the target hardware since the simulation uses the same C source code as the target system. The difference lies only in the lower level of the software: the display driver. Instead of using the actual display driver, the PC simulation uses a simulation driver which writes into a bitmap. The bitmap is then displayed on your screen using a second thread of the simulation. This second thread is invisible to the application; it behaves just as if the LCD routines were writing directly to the display.

### 4.1.1 Rotating and mirroring the screen

emWin supports rotating and/or mirroring of the screen. Please note that these features do not affect the simulation screen.

### 4.1.2 Using the simulation with the trial version of emWin

The trial version of emWin contains a full library which allows you to evaluate all available features of emWin. It also includes the emWin viewer (used for debugging applications), as well as demo versions of the Font Converter and the Bitmap Converter. Keep in mind that, being a trial version, you will not be able to view the source code of emWin or the simulation, but you will still be able to become familiar with what emWin can do.

#### 4.1.2.1 Directory structure

The directory structure of the simulation in the trial version is shown below. The table below explains the contents of the folders:

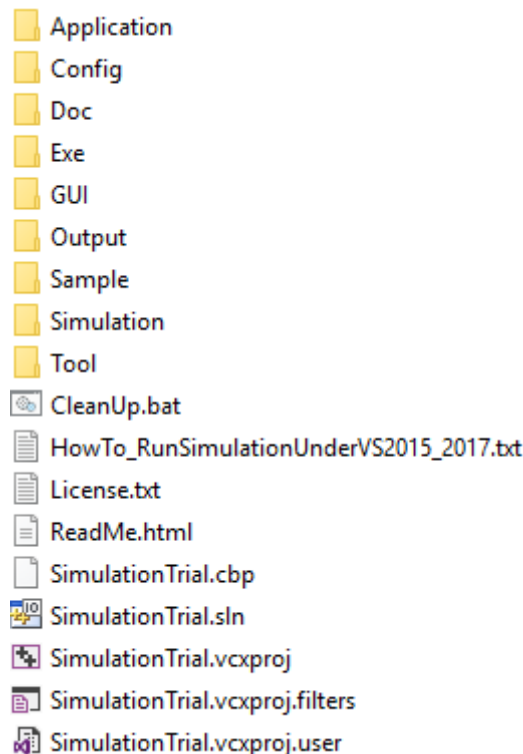

Directory	Content
Application	Source of the demo program.

Directory	Content
Config	Configuration files used to build the library. Note that changes at the header files do not have any effect on the precompiled library!
Doc	Document folder, contains emWin manual.
Exe	Ready-to-use demo program.
GUI	Library files and include files need to use the library.
Sample	Simulation examples.
Simulation	Files needed for the simulation.
Tool	Contains all emWin tools, such as the emWin viewer, a demo version of the Bitmap and Font Converter and more.

### 4.1.2.2 Visual C++ workspace

The root directory shown above includes the Microsoft Visual C++ solution (`SimulationTrial.sln`) and the rest of the project files. The workspace allows you to modify an application program and debug it before compiling it on your target system. Double-click the solution file to open the Microsoft Visual Studio IDE. The directory structure of the Visual C++ workspace will look like the one shown below.

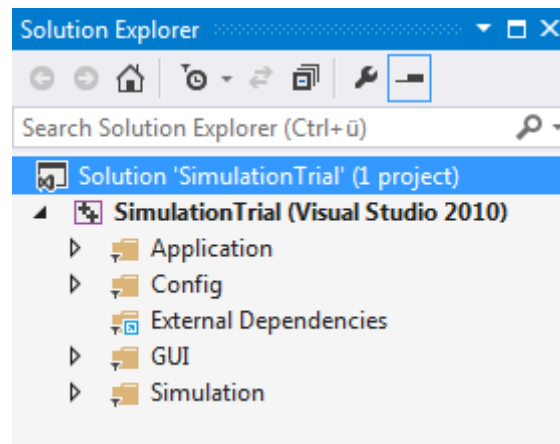

### 4.1.2.3 Compiling the demo program

The source files for the demo program are located in the `Application` directory as a ready-to-go simulation, meaning that you only need to rebuild and start it. Note that to rebuild the executable, you will need to have Microsoft Visual C++ (version 6.00 or later) installed.

- **Step 1:** Open the Visual C++ workspace by double-clicking on `SimulationTrial.sln`.
- **Step 2:** Rebuild the project by choosing **Build → Rebuild All** from the menu (or by pressing F7).
- **Step 3:** Start the simulation by choosing **Build → Start Debug → Go** from the menu (or by pressing F5). The demo project will begin to run and may be closed at any time by right-clicking on it and selecting **Exit**.

### 4.1.2.4 Compiling the samples

The `Sample` directory contains ready-to-go examples that demonstrate different features of emWin and provide examples of some of their typical uses. In order to build any of these executables, their C source must be 'activated' in the project. This is easily done with the following procedure:

- **Step 1:** Exclude the content of the `Application` folder from the build process by expanding the `Application` folder, selecting all files within it, right-clicking the marked files and setting **Properties → General → Exclude from build** to **yes**.
- **Step 2:** Add the desired example to the solution. Either add the example files by drag'n'drop to the solution or by right-clicking a folder in the solution (e.g. `Application`)

and selecting **Add → Existin Item....** Now navigate to the example files and add it to the soultion.

- **Step 3:** If the example contains its own configuration files (`LCDCConf.c` and/or `SIMConf.c`) the default configuration files located in the `config` folder need to be excluded from the build process (refer to step 1).
- **Step 4:** Rebuild the example by choosing **Build → Rebuild All** from the menu (or by pressing F7).
- **Step 5:** Start the simulation by choosing **Build → Start Debug → Go** from the menu (or by pressing F5). The result of the example selected above is pictured below:



### 4.1.3 Using the simulation with the emWin source

#### 4.1.3.1 Directory structure

The root directory of the simulation can be anywhere on your PC, for example `C:\Work\emWinSim`. The directory structure will appear as shown below. This structure is very similar to that which we recommend for your target application (see *Getting Started* on page 90 for more information).

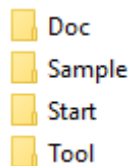

The following table shows the contents of the folders:

Directory	Content
Doc	Contains the emWin documentation.
Sample	Code examples, described later in this documentation.
Start	All you need to create a new project with emWin.
Tool	Tools shipped with emWin.

A new project can be started by making a copy of the Start-folder. It contains all required files for a new project. Subdirectories containing the emWin sources are in the `Start\GUI` folder and should contain the exact same files as the directories of the same names which are used for your target (cross) compiler. The files of the GUI subdirectories should not

be changed, as this would make updating to a newer version of emWin more difficult. The `Start\Config` directory contains configuration files which need to be modified in order to reflect your target hardware settings (mainly LCD-size and colors which can be displayed).

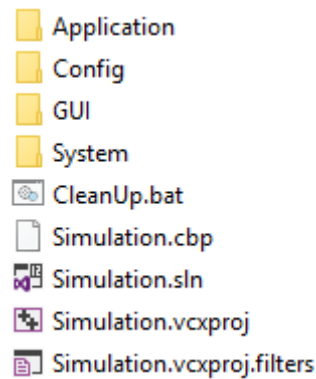

### 4.1.3.2 Visual C++ workspace

The root directory shown above includes the Microsoft Visual C++ workspace (`Simulation.dsw`) and project files (`Simulation.dsp`). The workspace allows you to modify an application program and debug it before compiling it on your target system. The directory structure of the Visual C++ workspace will appear similar to that shown to the right. Here, the `GUI` folder is open to display the emWin subdirectories. Note that your `GUI` directory may not look exactly like the one pictured, depending on which additional features of emWin you have. The folders `Core`, `Font` and `DisplayDriver` are part of the basic emWin package and will always appear in the workspace directory.

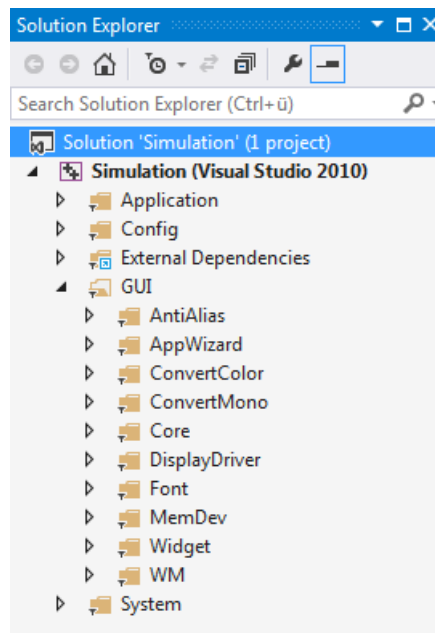

### 4.1.3.3 Compiling the application

The simulation contains one or more application C files (located in the `Application` directory), which can be modified or removed and additional files can be added to the project. You should then rebuild the program within the Visual C++ workspace in order to test/debug it. Once you have reached a point where you are satisfied with the result and want to use the program in your application, you should be able to compile these same files on your target system and get the same result on the target display. The general procedure for using the simulation would be as follows:

- **Step 1:** Open the Visual C++ workspace by double-clicking on `Simulation.dsw`.
- **Step 2:** Compile the project by choosing **Build** → **Rebuild All** from the menu (or by pressing F7).

- **Step 3:** Run the simulation by choosing **Build → Start Debug → Go** from the menu (or by pressing F5).
- **Step 4:** Replace the bitmap with your own logo or image.
- **Step 5:** Make further modifications to the application program as you wish, by editing the source code or adding/deleting files.
- **Step 6:** Compile and run the application program within Visual C++ to test the results. Continue to modify and debug as needed.
- **Step 7:** Compile and run the application program on your target system.

## 4.1.4 Advanced features of the simulation

Clicking the right mouse button shows a context menu with several advanced functions:

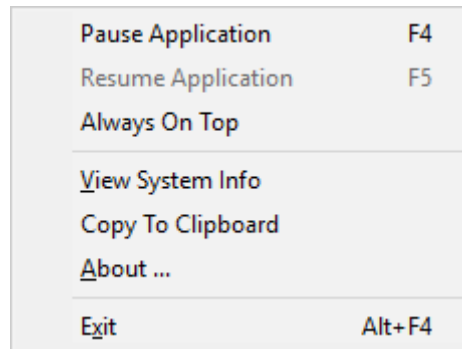

### 4.1.4.1 Pause and Resume

These menu items allow to pause and to resume the application currently running in the simulation. The same can be done by pressing **<F4>** or **<F5>**. Trying to pause an already paused application or trying to resume an already running application causes an error message.

### 4.1.4.2 View system info

This menu item opens a further window with information of the memory currently used by the application. The window continuously shows the current status of memory consumption by showing the free and used bytes and the free and used number of memory blocks.

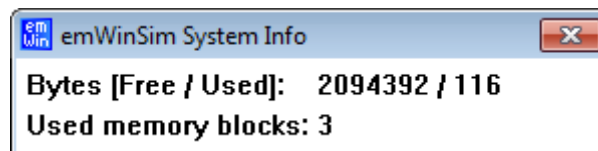

### 4.1.4.3 Copy to clipboard

This menu item copies the current contents of the display into the clipboard. This makes it easy to use it for documentation purpose with other applications.

## 4.2 Device simulation

The device simulation supports 3 views:

- Generated frame view
- Custom bitmap view
- Window view

The table below shows the different views:

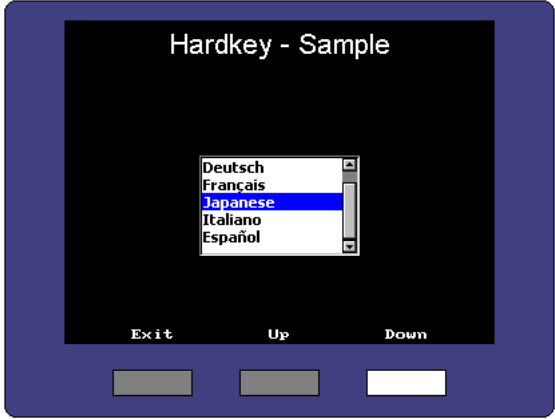
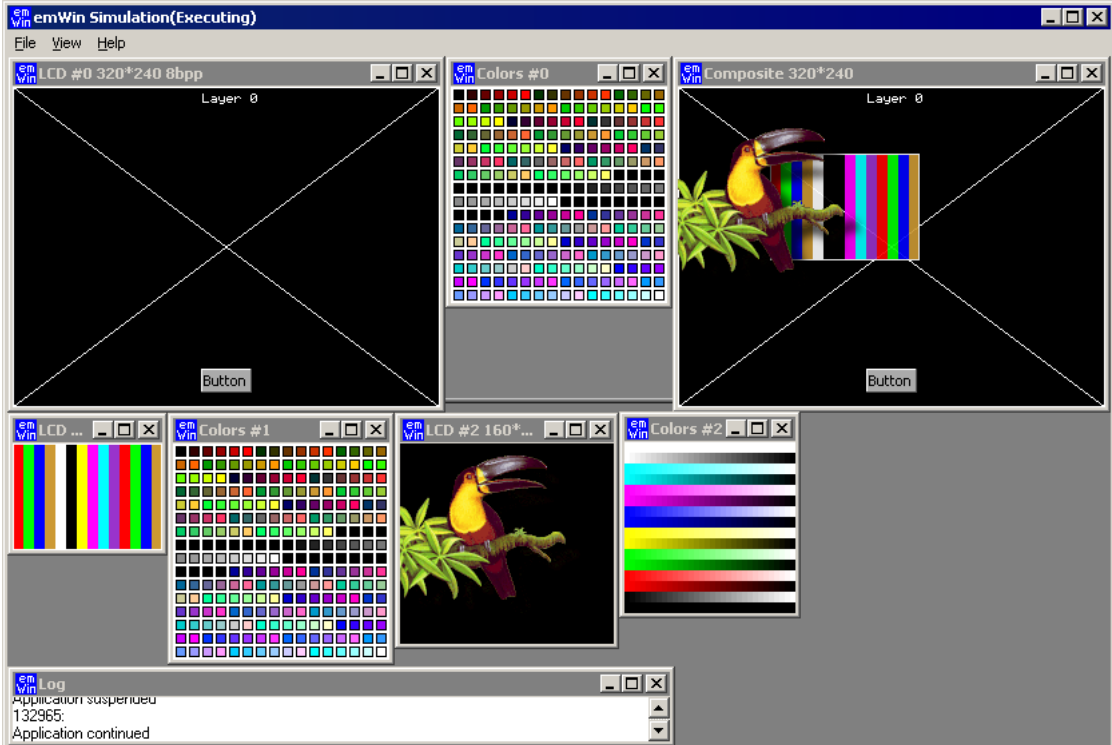
Generated frame view	Custom bitmap view
	
Window view	
	

The following will explain in detail how each option can be used.

### 4.2.1 Generated frame view

The simulation shows the display inside an automatically generated frame surrounding the display. The frame contains a small button which per default closes the application. This is the default behavior of the simulation for single layer systems. 'Single layer system' means that only the first layer is initialized.



## 4.2.2 Custom bitmap view

The simulation can show the simulated display in a bitmap of your choice, typically your target device. The bitmap can be used to simulate the behavior of the entire target device. In order to simulate the appearance of the device, bitmaps are required.

### Device bitmap

The first bitmap is usually a photo (top view) of the device, and needs to be named `Device.bmp`. It may be a separate file (in the same directory as the executable), or it may be included as a resource in the application. How to do this is explained later in this chapter. The file should provide an area for the simulated display of the same size in pixels as the physical display resolution.

If there are any hardkeys to be simulated the bitmap should also show all of them in unpressed state.

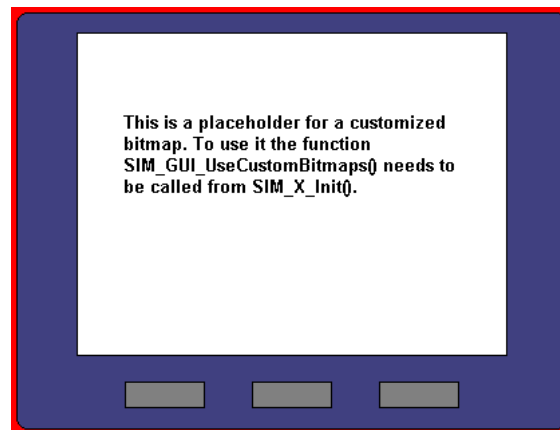

Transparent areas need to be colored with exact the same color as defined with the function `SIM_GUI_SetTransColor()`, typically red (`0xFF0000`). These areas do not have to be rectangular; they can have an arbitrary shape (up to a certain complexity which is limited by your operating system, but is normally sufficient). Red is the default color for transparent areas, mainly because it is not usually contained in most bitmaps. To use a bitmap with red, the default transparency color may be changed with the function `SIM_GUI_SetTransColor()`.

### Hardkey bitmap

The second bitmap file is required for defining the hardkeys and must be named `Device1.bmp`. It contains the buttons in pressed state. The non hardkey area has to be filled with the transparent color. This is only a short description. For more details about how to simulate hardkeys, see *Hardkey simulation* on page 226.

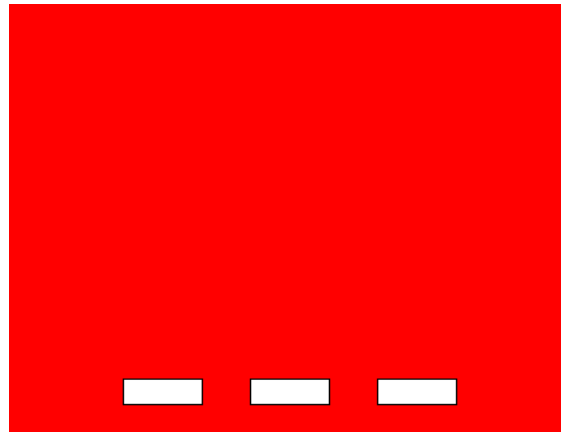

### Using separate files

When starting the simulation, it checks if the directory of the executable contains the bitmap files `Device.bmp` and `Device1.bmp`. If these files are available, they are used automatically and the resource bitmaps are ignored. Note that this is only valid with single layer systems.

### Adding the bitmap to the application resources

The resource file of the simulation can be found under `System\Simulation\Res\Simulation.rc`. It contains the following section:

```

////////////////////////////////////
//
// Customizable bitmaps
//
IDB_DEVICE          BITMAP  DISCARDABLE  "Device.bmp"
IDB_DEVICE1         BITMAP  DISCARDABLE  "Device1.bmp"

```

This section can be used to set custom device files. More information can be found in the Win32 documentation.

## 4.2.3 Window view

Default for simulating a multiple layer system is showing each layer in a separate window without using bitmaps or a generated frames.



## 4.3 Device simulation API

All of the device simulation API functions should be called in the setup phase. The calls should be done from within the routine `SIM_X_Config()`, which is located in the file `SIM-Conf.c` in the configuration folder. The example below calls `SIM_SetLCDPos()` in the setup:

```
#include "LCD_SIM.h"
void SIM_X_Config() {
    SIM_GUI_SetLCDPos(50, 20); // Define the position of the LCD in the bitmap
}
```

### Functions

Routine	Description
<code>SIM_GUI_Delay()</code>	Stops execution of simulation thread for the given period.
<code>SIM_GUI_EnableModifierKey()</code>	This function let modifier keys (ALT, CTRL) through to emWin.
<code>SIM_GUI_ExecIdle()</code>	Called by the simulation on idle time.
<code>SIM_GUI_GetCompositeTouch()</code>	Returns the layer index to be passed to emWin if the composite view is touched by the PID.
<code>SIM_GUI_GetTime()</code>	Returns the period of time in ms elapsed since starting the simulation.
<code>SIM_GUI_IsModifierKeyEnabled()</code>	This function indicates if modifier keys are turned on or not.
<code>SIM_GUI_SaveBMP()</code>	Saves a BMP file containing the current layer.
<code>SIM_GUI_SaveBMPEx()</code>	Saves a BMP file containing the given section of the current layer.
<code>SIM_GUI_SaveCompositeBMP()</code>	Saves a BMP file containing the current content of the composite view.
<code>SIM_GUI_SetCallback()</code>	Sets a callback function for receiving the handles of the simulation windows.
<code>SIM_GUI_SetCompositeColor()</code>	Sets the background color of the composite window. (Only used with MultiLayer support)
<code>SIM_GUI_SetCompositeSize()</code>	Enables composite window mode and sets the size of the composite window. (Only used with MultiLayer support)
<code>SIM_GUI_SetCompositeTouch()</code>	Sets the layer index to be used for touch events on the composite view.
<code>SIM_GUI_SetLCDColorBlack()</code>	Set the colors to be used as black on color monochrome displays.
<code>SIM_GUI_SetLCDColorWhite()</code>	Set the colors to be used as white on color monochrome displays.
<code>SIM_GUI_SetLCDPos()</code>	Sets the position for the simulated LCD within the target device bitmap.
<code>SIM_GUI_SetMag()</code>	Sets magnification factors for X and/or Y axis.
<code>SIM_GUI_SetTransColor()</code>	Sets the color to be used for transparent areas of device or hardkey bitmaps.
<code>SIM_GUI_SetTransMode()</code>	Sets the transparency mode for the given layer.
<code>SIM_GUI_ShowDevice()</code>	When using multiple layers, this function can be used to show the device bitmap.

Routine	Description
<a href="#">SIM_GUI_UseCustomBitmaps()</a>	Tells the simulation to use the custom bitmaps from the application resource file.

### Data structures

Structure	Description
<a href="#">SIM_GUI_INFO</a>	Contains the window handles of the simulation.

### Defines

Group of defines	Description
<a href="#">Transparency modes</a>	Available transparency modes for layers.

## 4.3.1 Functions

### 4.3.1.1 SIM\_GUI\_Delay()

#### Description

Stops execution of simulation thread for the given period.

#### Prototype

```
void SIM_GUI_Delay(int ms);
```

#### Parameters

Parameter	Description
ms	Period to be used.

### 4.3.1.2 SIM\_GUI\_EnableModifierKey()

#### Description

This function let modifier keys (ALT, CTRL) through to emWin.

#### Prototype

```
void SIM_GUI_EnableModifierKey(int OnOff);
```

#### Parameters

Parameter	Description
OnOff	Turn modifier keys on or off.

### 4.3.1.3 SIM\_GUI\_ExecIdle()

#### Description

Called by the simulation on idle time.

#### Prototype

```
void SIM_GUI_ExecIdle(void);
```

### 4.3.1.4 SIM\_GUI\_GetCompositeTouch()

#### Description

Returns the layer index to be passed to emWin if the composite view is touched by the PID.

#### Prototype

```
int SIM_GUI_GetCompositeTouch(void);
```

#### Return value

Layer index passed to emWin if the composite view is touched.

### 4.3.1.5 SIM\_GUI\_GetTime()

#### Description

Returns the period of time in ms elapsed since starting the simulation.

#### Prototype

```
int SIM_GUI_GetTime(void);
```

#### Return value

Period of time in ms elapsed since starting the simulation.

### 4.3.1.6 SIM\_GUI\_IsModifierKeyEnabled()

#### Description

This function indicates if modifier keys are turned on or not.

#### Prototype

```
int SIM_GUI_IsModifierKeyEnabled(void);
```

#### Return value

- |   |                            |
|---|----------------------------|
| 0 | Modifier keys are disabled |
| 1 | Modifier keys are enabled  |



### 4.3.1.7 SIM\_GUI\_SaveBMP()

#### Description

Saves a BMP file containing the current layer.

#### Prototype

```
int SIM_GUI_SaveBMP(const char * sFileName);
```

#### Parameters

Parameter	Description
<code>sFileName</code>	Filename to be used.

#### Return value

0        on success  
1        on error.

### 4.3.1.8 SIM\_GUI\_SaveBMPEx()

#### Description

Saves a BMP file containing the given section of the current layer.

#### Prototype

```
int SIM_GUI_SaveBMPEx(const char * sFileName,
                      int      x0,
                      int      y0,
                      int      xSize,
                      int      ySize);
```

#### Parameters

Parameter	Description
<code>sFileName</code>	Filename to be used.
<code>x0</code>	Left coordinate of the first pixels to be saved.
<code>y0</code>	Top coordinate of the first pixels to be saved.
<code>xSize</code>	X-size in pixels of the section to be saved.
<code>ySize</code>	Y-size in pixels of the section to be saved.

#### Return value

0        on success  
1        on error.

### 4.3.1.9 SIM\_GUI\_SaveCompositeBMP()

#### Description

Saves a BMP file containing the current content of the composite view.

#### Prototype

```
int SIM_GUI_SaveCompositeBMP(const char * sFileName);
```

#### Parameters

Parameter	Description
<code>sFileName</code>	Filename to be used.

#### Return value

0        on success  
1        on error.

### 4.3.1.10 SIM\_GUI\_SetCallback()

#### Description

If it is required to simulate more than the display window or hardkeys, you can set a callback function to receive the window handles of the simulation. This opens up the possibility e.g. to add additional controls outside of the display window like leds or sliders. Please note that the emWin functions can not be used there.

#### Prototype

```
void SIM_GUI_SetCallback(int (*pfCallback)(SIM_GUI_INFO * pInfo));
```

#### Parameters

Parameter	Description
<code>pfInfoCallback</code>	Pointer to the callback function. The function has to expect a pointer to a <code>SIM_GUI_INFO</code> structure as a parameter.

#### Elements of structure SIM\_GUI\_INFO

Data type	Element	Description
HWND	<code>hWndMain</code>	Handle to the main window.
HWND	<code>ahWndLCD[16]</code>	Array of handles to the display layers.
HWND	<code>ahWndColor[16]</code>	Array of handles to the palette layers.

### 4.3.1.11 SIM\_GUI\_SetCompositeColor()

#### Description

When simulating a multiple layer system each layer can be shown in its own window. However, the physical display has only one area. It shows the result of the blended layers. The simulation shows the result in the composite window which can have its own size independent of the layers. Each layer can have its own position and its own size within the composite window. This means that not necessarily the complete area is covered by the layers. For this case (and also for transparency effects) this function sets the default background color of the composite window.

#### Prototype

```
void SIM_GUI_SetCompositeColor(U32 Color);
```

#### Parameters

Parameter	Description
Color	Background color to be used.

#### Additional information

This function does not have an effect when using SoftLayers.

### 4.3.1.12 SIM\_GUI\_SetCompositeSize()

#### Note

This function also enables the composite window mode. It is used in `SIM_X_Config()`.

#### Description

As described above under `SIM_GUI_SetCompositeColor()` the size of the composite window is independent of the size of the layers. This function is used to set the size of the composite window, as well as enable the composite window mode.

#### Prototype

```
void SIM_GUI_SetCompositeSize(int xSize,
                             int ySize);
```

#### Parameters

Parameter	Description
<code>xSize</code>	Horizontal size in pixels.
<code>ySize</code>	Vertical size in pixels.

#### Example

This example screenshot shows the enabled composite window mode. The two layers are shown on the right and on the left is the composite window, which shows the two layers merged.



### 4.3.1.13 SIM\_GUI\_SetCompositeTouch()

#### Description

Sets the layer index to be passed to emWin if the composite view is touched by the PID.

#### Prototype

```
void SIM_GUI_SetCompositeTouch(int LayerIndex);
```

#### Parameters

Parameter	Description
<code>LayerIndex</code>	Layer index to be used for touch events on the composite view.

### 4.3.1.14 SIM\_GUI\_SetLCDColorBlack()

### 4.3.1.15 SIM\_GUI\_SetLCDColorWhite()

#### Description

Set the colors to be used as black or white, respectively, on color monochrome displays.

#### Prototypes

```
int SIM_GUI_SetLCDColorBlack(int DisplayIndex,
                             int Color);
```

```
int SIM_GUI_SetLCDColorWhite(int DisplayIndex,
                              int Color);
```

#### Parameters

Parameter	Description
<code>DisplayIndex</code>	Reserved for future use; must be 0.
<code>Color</code>	RGB value of the color.

#### Additional information

These functions can be used to simulate the true background color of your display. The default color values are black and white, or `0x000000` and `0xFFFFFFFF`. Refer to `SIM_GUI_SetLCDColorBlack()` for an example.

#### Example using default settings

```
void SIM_X_Config() {
    SIM_GUI_SetLCDPos(14,84); // Define the position of the LCD
                              // in the bitmap
    SIM_GUI_SetLCDColorBlack (0, 0x000000); // Define the color used as black
    SIM_GUI_SetLCDColorWhite (0, 0xFFFFFFFF); // Define the color used as white
    (used for colored monochrome displays)
}
```

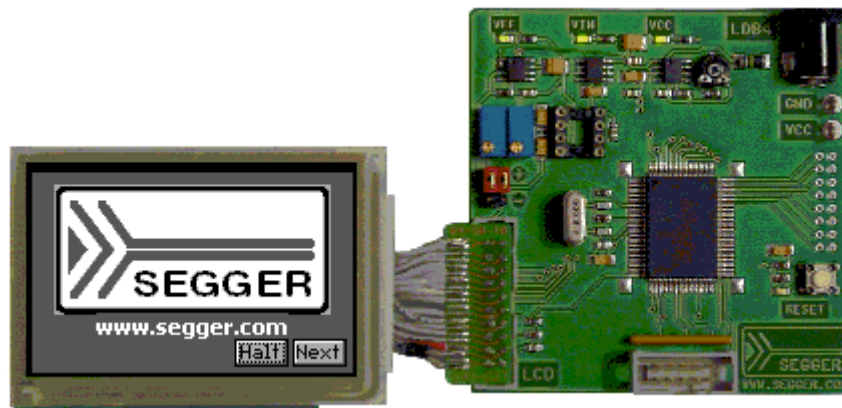

#### Example using yellow instead of white

```
void SIM_X_Config() {
    SIM_GUI_SetLCDPos(14,84); // Define the position of the LCD
                              // in the bitmap
    SIM_GUI_SetLCDColorBlack (0, 0x000000); // Define the color used as black
    SIM_GUI_SetLCDColorWhite (0, 0x00FFFF); // Define the color used as white
    (used for colored monochrome displays)
}
```



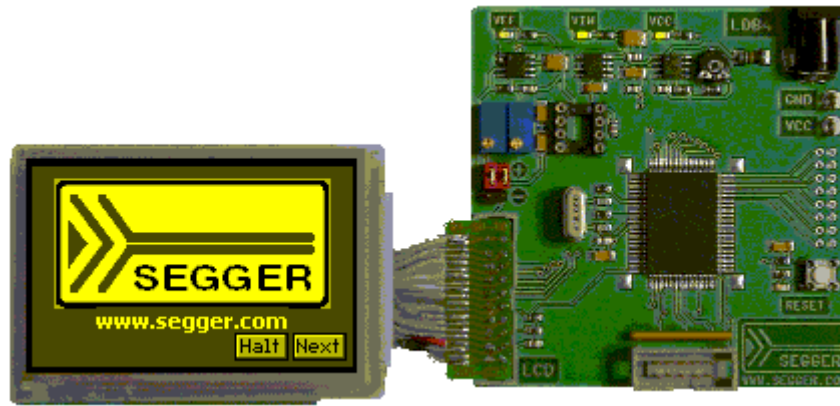

### 4.3.1.16 SIM\_GUI\_SetLCDPos()

#### Description

Sets the position for the simulated LCD within the target device bitmap.

#### Prototype

```
void SIM_GUI_SetLCDPos(int xPos,  
                      int yPos);
```

#### Parameters

Parameter	Description
xPos	X-position of the upper left corner for the simulated LCD (in pixels).
yPos	Y-position of the upper left corner for the simulated LCD (in pixels).

#### Additional information

The X- and Y-positions are relative to the target device bitmap, therefore position (0,0) refers to the upper left corner (origin) of the bitmap and not your actual LCD. Only the origin of the simulated screen needs to be specified; the resolution of your display should already be reflected in the configuration files in the Config directory. The use of this function enables the use of the bitmaps Device.bmp and Device1.bmp . Note that the values need to be  $\geq 0$  for enabling the use of the bitmaps. If the use of the device bitmaps should be disabled, omit the call of this function in `SIM_X_Init()`.

### 4.3.1.17 SIM\_GUI\_SetMag()

#### Description

Sets magnification factors for X and/or Y axis.

#### Prototype

```
void SIM_GUI_SetMag(int MagX,  
                   int MagY);
```

#### Parameters

Parameter	Description
MagX	Magnification factor for X axis.
MagY	Magnification factor for Y axis.

#### Additional information

Per default the simulation uses one pixel on the PC for each pixel of the simulated display. The use of this function makes sense for small displays. If using a device bit- map together with a magnification > 1 the device bitmap needs to be adapted to the magnification. The device bitmap is not magnified automatically.

### 4.3.1.18 SIM\_GUI\_SetTransColor()

#### Description

Sets the color to be used for transparent areas of device or hardkey bitmaps.

#### Prototype

```
int SIM_GUI_SetTransColor(int Color);
```

#### Parameters

Parameter	Description
Color	RGB value of the color in the format 00000000RRRRRRRRGGGGGGGGBBBBBBB.

#### Additional information

The default setting for transparency is bright red (0xFF0000). You would typically only need to change this setting if your bitmap contains the same shade of red.

### 4.3.1.19 SIM\_GUI\_SetTransMode()

#### Description

Sets the transparency mode for the given layer.

#### Prototype

```
void SIM_GUI_SetTransMode(int LayerIndex,  
                          int TransMode);
```

#### Parameters

Parameter	Description
<a href="#">LayerIndex</a>	Index of the layer for which the transparency mode should be set.
<a href="#">TransMode</a>	Permitted values are listed under <i>Transparency modes</i> on page 225.

### 4.3.1.20 SIM\_GUI\_ShowDevice()

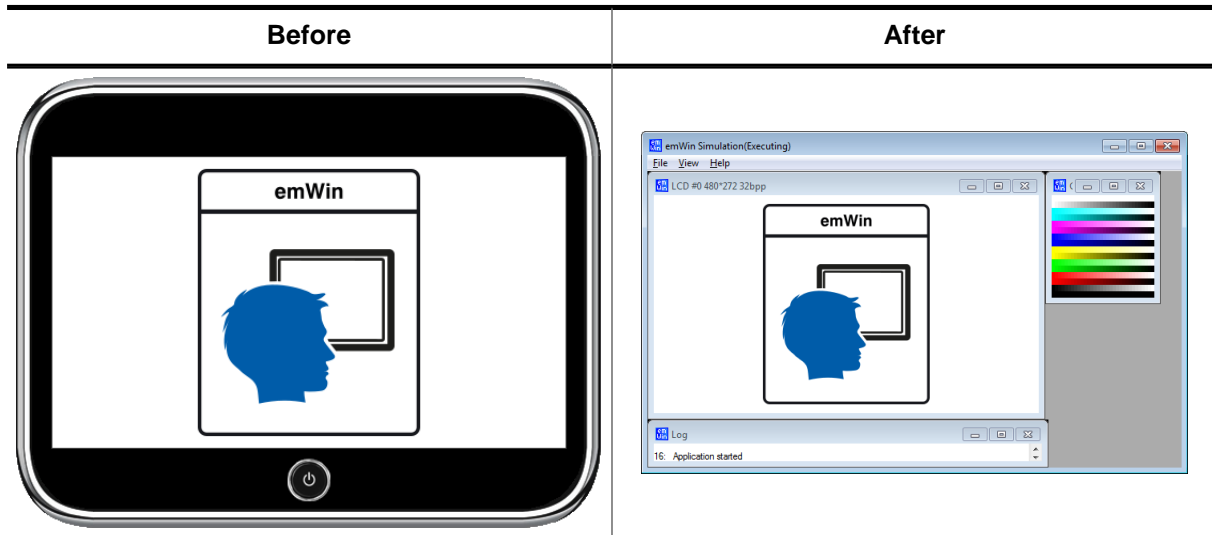

#### Description

When using multiple layers, this function can be used to show the device bitmap. By default each layer and the composite view are displayed in separate windows.

#### Prototype

```
void SIM_GUI_ShowDevice(int OnOff);
```

#### Parameters

Parameter	Description
OnOff	1 for showing the bitmap, 0 for hiding it.

#### Additional information

If using a multi-layer configuration and showing the device bitmap, only the composite view is shown. Because of this, the routine `SIM_GUI_SetCompositeSize()` also needs to be called in `SIM_X_Config()`.

### 4.3.1.21 SIM\_GUI\_UseCustomBitmaps()

#### Description

As described earlier in this chapter it is possible to use device bitmaps from the application resources. This function tells the simulation to use the device- and hardkey bitmaps from the application resources and not to generate the default frame bitmap.

#### Prototype

```
void SIM_GUI_UseCustomBitmaps(void);
```

#### Additional information

The emWin shipment contains per default 2 bitmaps, Device.bmp and Device1.bmp, located in `Start\System\Simulation\Res` which can be used as a starting point for your own bitmaps.

## 4.3.2 Data structures

### 4.3.2.1 SIM\_GUI\_INFO

#### Description

Contains the window handles of the simulation. This structure is required for `SIM_GUI_Set-Callback()`.

#### Type definition

```
typedef struct {  
    HWND  hWndMain;  
    HWND  ahWndLCD[];  
    HWND  ahWndColor[];  
} SIM_GUI_INFO;
```

#### Structure members

Member	Description
<code>hWndMain</code>	Handle to the main window.
<code>ahWndLCD</code>	Array of handles to the display layers.
<code>ahWndColor</code>	Array of handles to the palette layers.



## 4.3.3 Defines

### 4.3.3.1 Transparency modes

#### Description

Available transparency modes for layers.

#### Definition

```
#define GUI_TRANSMODE_PIXELALPHA 0
#define GUI_TRANSMODE_ZERO 2
```

#### Symbols

Definition	Description
<a href="#">GUI_TRANSMODE_PIXELALPHA</a>	The alpha value is taken from the pixel data in order to mix colors with the according background.
<a href="#">GUI_TRANSMODE_ZERO</a>	In this mode pixels are fully transparent if the pixel data equals 0.

## 4.4 Hardkey simulation

The hardkey simulation can only be used in the custom bitmap view. Hardkeys may also be simulated as part of the device, and may be selected with the mouse pointer. The idea is to be able to distinguish whether a key or button on the simulated device is pressed or unpressed. A hardkey is considered “pressed” as long as the mouse button is held down; releasing the mouse button or moving the pointer off of the hardkey releases the key. A toggle behavior between pressed and unpressed may also be specified with the routine `SIM_HARDKEY_SetMode()`. In order to simulate hardkeys, you need a second bitmap of the device which is transparent except for the keys themselves (in their pressed state). As described earlier in this chapter, this bitmap can be in a separate file in the directory, or included as a resource in the executable. Hardkeys may be any shape, as long as they are exactly the same size in pixels in both `Device.bmp` and `Device1.bmp`. The following example illustrates this:

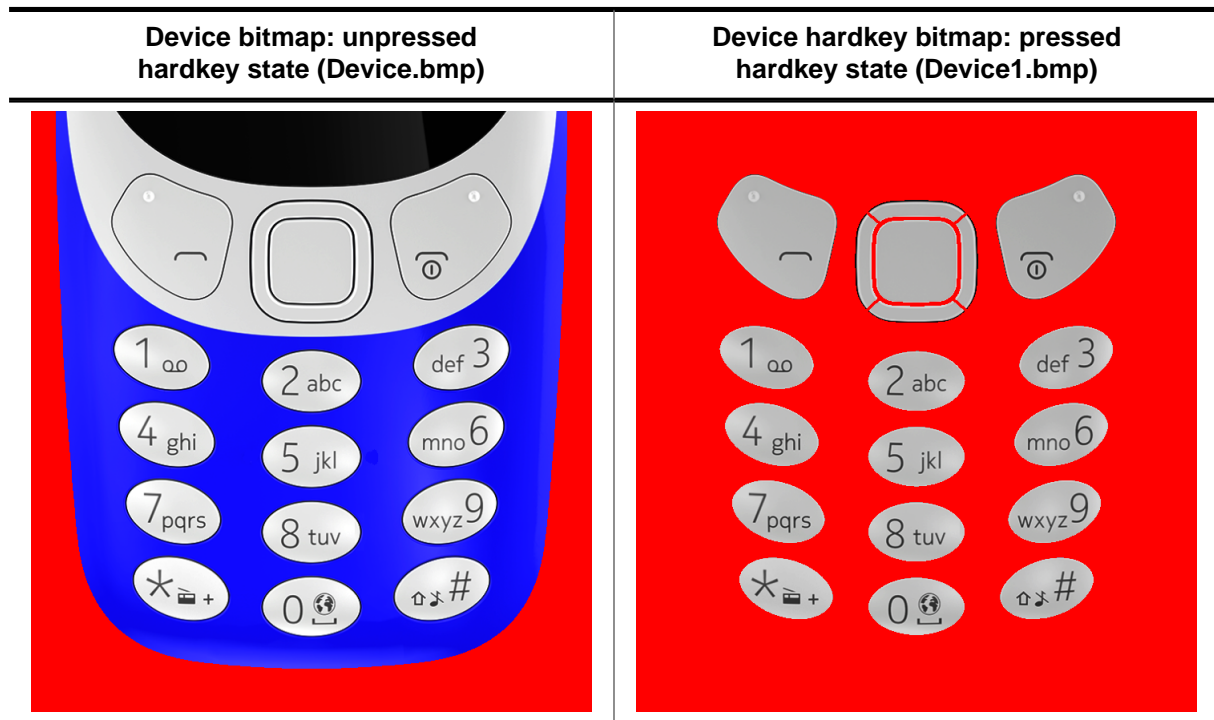

When a key is “pressed” with the mouse, the corresponding section of the hardkey bitmap (`Device1.bmp`) will overlay the device bitmap in order to display the key in its pressed state. The keys may be polled periodically to determine if their states (pressed/unpressed) have changed and whether they need to be updated. Alternatively, a callback routine may be set to trigger a particular action to be carried out when the state of a hardkey changes.

### 4.4.1 Hardkey simulation API

The hardkey simulation functions are part of the standard simulation program shipped with emWin. If using a user defined emWin simulation these functions may not be available. The table below lists the available hardkey-simulation-related routines in alphabetical order within their respective categories. Detailed descriptions of the routines follow:

Routine	Description
<a href="#">SIM_HARDKEY_GetNum()</a>	Returns the number of available hardkeys.
<a href="#">SIM_HARDKEY_GetState()</a>	Returns the state of a specified hardkey.
<a href="#">SIM_HARDKEY_SetCallback()</a>	Sets a callback routine to be executed when the state of a specified hardkey changes.
<a href="#">SIM_HARDKEY_SetMode()</a>	Sets the behavior for a specified hardkey.
<a href="#">SIM_HARDKEY_SetState()</a>	Sets the behavior for a specified hardkey.

### 4.4.1.1 SIM\_HARDKEY\_GetNum()

#### Description

Returns the number of available hardkeys.

#### Prototype

```
int SIM_HARDKEY_GetNum(void);
```

#### Return value

The number of available hardkeys found in the bitmap.

#### Additional information

The numbering order for hardkeys is standard reading order (left to right, then top to bottom). The topmost pixel of a hardkey is therefore found first, regardless of its horizontal position. In the bitmap below, for example, the hardkeys are labeled as they would be referenced by the [KeyIndex](#) parameter in other functions:

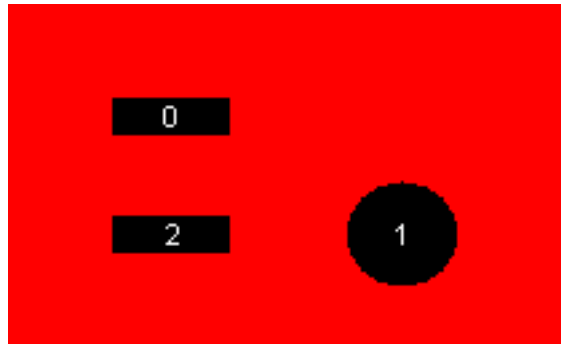

It is recommended to call this function in order to verify that a bitmap is properly loaded.

### 4.4.1.2 SIM\_HARDKEY\_GetState()

#### Description

Returns the state of a specified hardkey.

#### Prototype

```
int SIM_HARDKEY_GetState(unsigned int i);
```

#### Parameters

Parameter	Description
<code>KeyIndex</code>	Index of hardkey (0 = index of first key).

#### Return value

State of the specified hardkey.

- 0       unpressed.
- 1       pressed.

### 4.4.1.3 SIM\_HARDKEY\_SetCallback()

#### Description

Sets a callback routine to be executed when the state of a specified hardkey changes.

#### Prototype

```
SIM_HARDKEY_CB *SIM_HARDKEY_SetCallback(unsigned int    KeyIndex,
                                       SIM_HARDKEY_CB * pfCallback);
```

#### Parameters

Parameter	Description
<a href="#">KeyIndex</a>	Index of hardkey (0 = index of first key).
<a href="#">pfCallback</a>	Pointer to callback routine.

#### Return value

Pointer to the previous callback routine.

#### Additional information

Note that multi tasking support has to be enabled if GUI functions need to be called within the callback functions. Without multi tasking support only the GUI functions which are allowed to be called within an interrupt routine should be used. The callback routine must have the following prototype:

#### Prototype of SIM\_HARDKEY\_CB

```
void SIM_HARDKEY_CB(int KeyIndex,
                   int State);
```

Parameter	Description
<a href="#">KeyIndex</a>	Index of hardkey (0 = index of first key).
<a href="#">State</a>	State of the specified hardkey. 0 for unpressed, 1 for pressed.

#### 4.4.1.4 SIM\_HARDKEY\_SetMode()

##### Description

Sets the behavior for a specified hardkey.

##### Prototype

```
int SIM_HARDKEY_SetMode(unsigned int KeyIndex,  
                        int Mode);
```

##### Parameters

Parameter	Description
<a href="#">KeyIndex</a>	Index of hardkey (0 = index of first key).
<a href="#">Mode</a>	Behavior mode. 0 for normal behavior (default), 1 for toggle behavior.

##### Additional information

Normal (default) hardkey behavior means that a key is considered pressed only as long as the mouse button is held down on it. When the mouse is released or moved off of the hardkey, the key is considered unpressed.

With toggle behavior, each click of the mouse toggles the state of a hardkey to pressed or unpressed. That means if you click the mouse on a hardkey and it becomes pressed, it will remain pressed until you click the mouse on it again.

### 4.4.1.5 SIM\_HARDKEY\_SetState()

#### Description

Sets the behavior for a specified hardkey.

#### Prototype

```
int SIM_HARDKEY_SetState(unsigned int i,  
                        int State);
```

#### Parameters

Parameter	Description
<a href="#">KeyIndex</a>	Index of hardkey (0 = index of first key).
<a href="#">State</a>	<a href="#">State</a> of the specified hardkey. See table below.

#### Return value

Previous state of the key updated.

#### Additional information

This function is only usable when `SIM_HARDKEY_SetMode()` is set to 1 (toggle mode).

## 4.5 Integrating the emWin simulation into an existing simulation

In order to integrate the emWin simulation into an existing simulation, the source code of the simulation is not required. Only in some rare cases it is required to use the source code of the simulation. If required the source code of the simulation can be purchased separately and it is not part of a normal emWin shipment.

As described earlier in this chapter the basic package and the trial version contains a simulation library. The API functions of this library can be used if for example the emWin simulation should be added to an existing hardware or real time kernel (RTOS) simulation.

To add the emWin simulation to an existing simulation (written in C or C++, using the Win32 API), only a few lines of code need to be added.

### 4.5.1 Directory structure

The subfolder Simulation of the System folder contains the emWin simulation. The directory structure is shown on the right. The table below explains the contents of the subfolders:

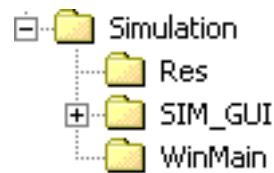

Directory	Content
Simulation	Simulation source and header files to be used with and without the simulation source code. The folder also contains a ready to use simulation library.
Res	Resource files.
SIM_GUI	GUI simulation source code (optional).
WinMain	Contains the WinMain routine.

### 4.5.2 Using the simulation library

The following steps will show how to use the simulation library to integrate the emWin simulation into an existing simulation:

- **Step 1:** Add the simulation library `GUISim.lib` to the project.
- **Step 2:** Add all GUI files to the project as described in the chapter *Subdirectories* on page 92.
- **Step 3:** Add the include directories to the project as described in the chapter *Include Directories*.
- **Step 4:** Modify `WinMain()` or `SIM_OS.c`.

#### 4.5.2.1 Modifying WinMain

Every windows Win32 program starts with `WinMain()` (contrary to a normal C program from the command line, which starts with `main()`). All that needs to be done is to add a few lines of code to this routine.

The following function calls need to be added (normally in the order as it is shown in the following application code example):

- `SIM_GUI_Enable()`
- `SIM_GUI_Init()`
- `SIM_GUI_CreateLCDWindow()`
- `CreateThread()`
- `SIM_GUI_Exit()`



## 4.5.2.2 Example application

The following application is available under `Sample\WinMain\SampleApp.c` and shows how to integrate the emWin simulation into an existing application:

```
#include <windows.h>
#include "GUI_SIM_Win32.h"
void MainTask(void);
/*****
 *
 *      _Thread
 */
static DWORD __stdcall _Thread(void * Parameter) {
    MainTask();
    return 0;
}
/*****
 *
 *      _WndProcMain
 */
static LRESULT CALLBACK _WndProcMain(HWND hWnd, UINT message,
                                     WPARAM wParam, LPARAM lParam) {
    SIM_GUI_HandleKeyEvents(message, wParam);
    switch (message) {
        case WM_DESTROY:
            PostQuitMessage(0);
            break;
    }
    return DefWindowProc(hWnd, message, wParam, lParam);
}
/*****
 *
 *      _RegisterClass
 */
static void _RegisterClass(HINSTANCE hInstance) {
    WNDCLASSEX wcex;
    memset(&wcex, 0, sizeof(wcex));
    wcex.cbSize = sizeof(WNDCLASSEX);
    wcex.hInstance = hInstance;
    wcex.style = CS_HREDRAW | CS_VREDRAW;
    wcex.lpfnWndProc = (WNDPROC)_WndProcMain;
    wcex.hIcon = 0;
    wcex.hCursor = LoadCursor(NULL, IDC_ARROW);
    wcex.hbrBackground = (HBRUSH)(COLOR_APPWORKSPACE + 1);
    wcex.lpszMenuName = 0;
    wcex.lpszClassName = "GUIApplication";
    RegisterClassEx(&wcex);
}
/*****
 *
 *      WinMain
 */
int APIENTRY WinMain(HINSTANCE hInstance, HINSTANCE hPrevInstance,
                    LPSTR lpCmdLine, int nCmdShow) {
    DWORD ThreadID;
    MSG Msg;
    HWND hWndMain;
    //
    // Register window class
    //
    _RegisterClass(hInstance);
    //
    // Make sure the driver configuration is done
    //
    SIM_GUI_Enable();
    //
    // Create main window
```

```

//
hWndMain = CreateWindow("GUIApplication", "Application window",
                        WS_OVERLAPPEDWINDOW | WS_CLIPCHILDREN | WS_VISIBLE,
                        0, 0, 328, 267, NULL, NULL, hInstance, NULL);

//
// Initialize the emWin simulation and create an LCD window
//
SIM_GUI_Init(hInstance, hWndMain, lpCmdLine, "embOS - emWin Simulation");
SIM_GUI_CreateLCDWindow(hWndMain, 0, 0, 320, 240, 0);
//
// Create a thread which executes the code to be simulated
//
CreateThread(NULL, 0, (LPTHREAD_START_ROUTINE)_Thread, NULL, 0, &ThreadID);
//
// Main message loop
//
while (GetMessage(&Msg, NULL, 0, 0)) {
    TranslateMessage(&Msg);
    DispatchMessage(&Msg);
}
SIM_GUI_Exit();
}

```

## 4.5.3 Integration into the embOS Simulation

### 4.5.3.1 SIM\_OS.c

The following code example shows how to modify the existing `SIM_OS.c` of the embOS simulation in order to integrate the emWin simulation. Only four lines of coded have to be added to the function `_WindowThread()`. Add an include of `GUI_SIM_Win32.h` and the three function calls with prefix `SIM_GUI_<FunctionName>()` as shown below:

```

...
#include "GUI_SIM_Win32.h"
...
static DWORD WINAPI _WindowThread(LPVOID lpParameter) {
    BITMAP    BmpDevice;
    HINSTANCE hInstance;
    HACCEL    hAcceleratorTable;
    MSG       Msg;

    OS_USEPARA(lpParameter);
    //
    // Create a window. This window is used to simulate blinking LEDs.
    //
    _RegisterClass();
    hInstance = GetModuleHandle(NULL);
    hAcceleratorTable = LoadAccelerators(hInstance,
                                        MAKEINTRESOURCE(SIM_OS_IDC_WINMAIN));

    _hBmpDevice
    = (HBITMAP)LoadImage(hInstance, MAKEINTRESOURCE(SIM_OS_IDB_DEVICE),
                       IMAGE_BITMAP, 0, 0, 0);

    _hMenuPopup
    = LoadMenu(hInstance, MAKEINTRESOURCE(SIM_OS_IDC_CONTEXTMENU));
    _hMenuPopup = GetSubMenu(_hMenuPopup, 0);
    //
    // Create main window
    //
    GetObject(_hBmpDevice, sizeof(BmpDevice), &BmpDevice);
    _hWnd = CreateWindowEx(0, _sWindowClass, "embOS Simulation",
                          WS_SYSMENU | WS_CLIPCHILDREN | WS_POPUP | WS_VISIBLE,
                          10, 20, BmpDevice.bmWidth, BmpDevice.bmHeight, NULL,
                          NULL, hInstance, NULL);

    if (_hWnd == NULL) {
        _ErrorWin32("Could not create window.");
    }
}

```

```

    return -1; // Error
}
//
// Init emWin simulation and create window
//
SIM_GUI_Enable();
SIM_GUI_Init(hInstance, _hWnd, "", "embOS - emWin Simulation");
SIM_GUI_CreateLCDWindow(_hWnd, 0, 0, 320, 240, 0);
//
// Show main window
//
ShowWindow(_hWnd, SW_SHOWNORMAL);
#if defined(SIM_OS_TIMER_PERIOD) && (SIM_OS_TIMER_PERIOD != 0)
//
// Create a timer which is periodically invalidating the Win32 window in order
// to redraw it
//
SetTimer(_hWnd, 0, SIM_OS_TIMER_PERIOD, _cbTimer);
#endif
//
// Handle message loop
//
while (GetMessage(&Msg, NULL, 0, 0)) {
    if (!TranslateAccelerator(_hWnd, hAcceleratorTable, &Msg)) {
        TranslateMessage(&Msg);
        DispatchMessage(&Msg);
    }
}
ExitProcess(0);
return 0;
}

```

### 4.5.3.2 Target program (main)

The emWin API can be called from one or more target threads. Without RTOS, the WIN32 API function `CreateThread` is normally used to create a target thread which calls the emWin API; within an RTOS simulation, a target task/thread (Created by the simulated RTOS) is used to call the emWin API. In other words: Use `OS_CreateTask` to create a task for the user interface. Below a modified embOS start application:

```

#include <windows.h>
#include "RTOS.H"
#include "HW_LED.h"
#include "GUI.h"
OS_STACKPTR int Stack0[128], Stack1[128], Stack2[2000]; // Task stacks
OS_TASK TCB0, TCB1, TCB2; // Task-control-blocks
void Task0(void) {
    while (1) {
        HW_LED_Toggle0();
        OS_Delay(100);
    }
}
void Task1(void) {
    while (1) {
        HW_LED_Toggle1();
        OS_Delay(500);
    }
}
void MainTask(void) {
    int i;
    GUI_COLOR aColor[] = {GUI_RED, GUI_YELLOW};
    GUI_Init();
    while (1) {
        for (i = 0; i < 2; i++) {
            GUI_Clear();
            GUI_SetColor(aColor[i]);

```

```

GUI_SetFont(&GUI_FontComic24B_ASCII);
GUI_DispStringAt("Hello world!", 1, 1);
OS_Delay(200);
}
}
}
}
/*****
*
*      main
*/
void main(void) {
    OS_IncDI();           // Initially disable interrupts
    OS_InitKern();        // Initialize OS
    OS_InitHW();          // Initialize Hardware for OS
    //
    // At least one task here needs to be created here
    //
    OS_CREATETASK(&TCB0, "HP Task", Task0, 100, Stack0);
    OS_CREATETASK(&TCB1, "LP Task", Task1, 50, Stack1);
    OS_CREATETASK(&TCB2, "GUI Task", MainTask, 80, Stack2);
    OS_Start();           // Start multitasking
}

```

The following table shows the simulation before and after integrating the emWin simulation:

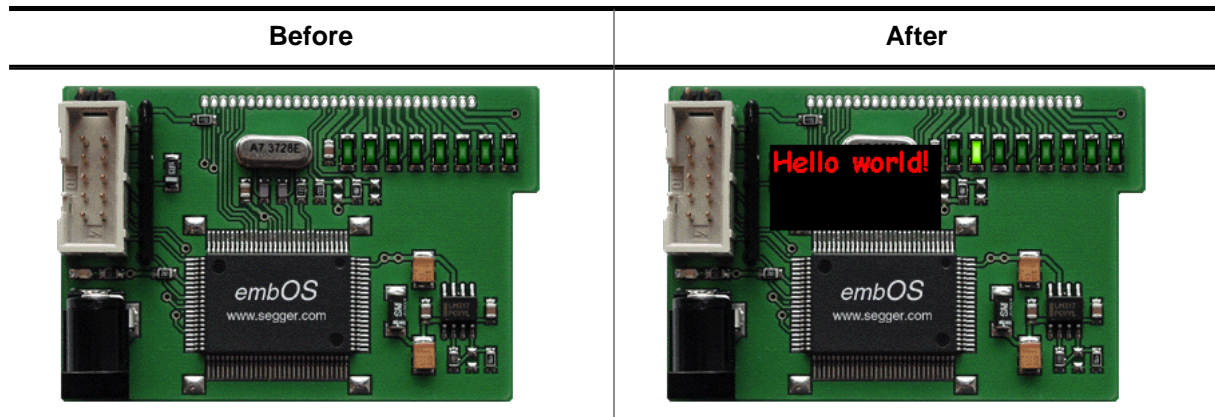

### 4.5.4 GUI simulation API

The table below lists the available routines for user defined simulation programs in alphabetical order within their respective categories. The functions are only available with the source code of the emWin simulation. Detailed descriptions of the routines follow:

Routine	Description
<code>SIM_GUI_CreateLCDInfoWindow()</code>	Creates a window which shows the available colors for the given layer.
<code>SIM_GUI_CreateLCDWindow()</code>	Creates a window which simulates a LCD display with the given size at the given position.
<code>SIM_GUI_Enable()</code>	Executes memory and driver configuration.
<code>SIM_GUI_Exit()</code>	Stops the GUI simulation.
<code>SIM_GUI_Init()</code>	Initializes the GUI simulation.
<code>SIM_GUI_SetLCDWindowHook()</code>	Sets a hook function to be called from the simulation if the LCD window receives a message.

### 4.5.4.1 SIM\_GUI\_CreateLCDInfoWindow()

#### Description

Creates a window which shows the available colors for the given layer.

#### Prototype

```
HWND SIM_GUI_CreateLCDInfoWindow(HWND hParent,
                                int x,
                                int y,
                                int xSize,
                                int ySize,
                                int LayerIndex);
```

#### Parameters

Parameter	Description
<code>hParent</code>	Handle of the parent window.
<code>x</code>	X position in parent coordinates.
<code>y</code>	Y position in parent coordinates.
<code>xSize</code>	X size in pixel of the new window. Should be 160 if using a color depth between 1 and 8 or 128 if working in high color mode.
<code>ySize</code>	Y size in pixel of the new window. Should be 160 if using a color depth between 1 and 8 or 128 if working in high color mode.
<code>LayerIndex</code>	Index of the layer to be shown.

#### Return value

Handle of the created window.

#### Additional information

The created color window has no frame, no title bar and no buttons.

#### Example

```
SIM_GUI_CreateLCDInfoWindow(hWnd, 0, 0, 160, 160, 0);
```

#### Screenshot



### 4.5.4.2 SIM\_GUI\_CreateLCDWindow()

#### Description

Creates a window which simulates a LCD display with the given size at the given position.

#### Prototype

```
HWND SIM_GUI_CreateLCDWindow(HWND hParent,
                              int x,
                              int y,
                              int xSize,
                              int ySize,
                              int LayerIndex);
```

#### Parameters

Parameter	Description
<code>hParent</code>	Handle of the parent window.
<code>x</code>	X position in parent coordinates.
<code>y</code>	Y position in parent coordinates.
<code>xSize</code>	X size in pixel of the new window.
<code>ySize</code>	Y size in pixel of the new window.
<code>LayerIndex</code>	Index of the layer to be shown.

#### Return value

Handle of the created window.

#### Additional information

All display output to the given layer will be shown in this window. The size of the window should be the same as configured in LCDConf.c. The created simulation window has no frame, no title bar and no buttons.

### 4.5.4.3 SIM\_GUI\_Enable()

#### Description

The function needs to be called at the beginning of the application to make sure that memory and driver will be configured at first.

#### Prototype

```
void SIM_GUI_Enable(void);
```

#### 4.5.4.4 SIM\_GUI\_Exit()

##### Description

The function should be called before the simulation returns to the calling process.

##### Prototype

```
void SIM_GUI_Exit(void);
```



### 4.5.4.5 SIM\_GUI\_Init()

#### Description

This function initializes the emWin simulation and should be called before any other SIM\_GUI... function call.

#### Prototype

```
int SIM_GUI_Init(          HINSTANCE  hInst,
                          HWND        hWndMain,
                          char        * pCmdLine,
                          const char  * sAppName);
```

#### Parameters

Parameter	Description
<a href="#">hInst</a>	Handle to current instance passed to WinMain.
<a href="#">hWndMain</a>	Handle to current instance passed to WinMain.
<a href="#">pCmdLine</a>	Pointer to command line passed to WinMain
<a href="#">sAppName</a>	Pointer to a string that contains the application name.

#### Return value

0        on success  
1        on error.

#### Additional information

The parameters [hWndMain](#) and [sAppName](#) are used in case a message box should be displayed.

#### 4.5.4.6 SIM\_GUI\_SetLCDWindowHook()

##### Description

Sets a hook function to be called from the simulation if the LCD window receives a message.

##### Prototype

```
void SIM_GUI_SetLCDWindowHook(SIM_GUI_tfHook * pfHook);
```

##### Parameters

Parameter	Description
<code>pfHook</code>	Pointer to hook function.

##### Return value

The hook function should return 0 if the message has been processed. In this case the GUI simulation ignores the message.

# Chapter 5

## emWin in Web Browsers: Emscripten support

---

With the use of WebAssembly, it is possible to run emWin applications in web browsers. This is achieved through [Emscripten](#) which is a complete compiler toolchain for compilation to WebAssembly.

By utilising Emscripten, virtually any emWin application can be compiled for any browser that supports WebAssembly.

Emscripten is made available under two permissive open source licenses: the MIT license and the University of Illinois/NCSA Open Source License.



*Copyright © 2013 Alon Zakai*

## 5.1 Introduction

With Emscripten, virtually any emWin application can be compiled for any browser that supports WebAssembly. This includes all major browsers:

- Google Chrome and other Chromium-based browsers
- Firefox
- Safari
- Microsoft Edge
- Opera

Examples of how this looks in a browser environment can be found on our website on the [emWin example page](#).

### Requirements

- emWin source code
- emWin4Web (tool for compilation)

### Limitations

- Multi-layer configurations
- Applications without multi-buffering or framebuffer cache locking
- Multi-touch

## 5.2 Compiling and running applications

emWin applications can be built with Emscripten with emWin's new tool **emWin4Web**. Please see the corresponding chapter for more information on how to build.

## 5.3 Limitations

This sub-section will go more into detail about the aforementioned limitations.

### Multi-layer configurations

Configurations with multiple layers are not supported. This is because the framework running emWin does not have any hardware layers that we could draw into.

### Applications without multi-buffering or framebuffer cache locking

The framework running the emWin application expects a signal from emWin to update the frame buffer. This is done using either the multi-buffering or the cache mechanism, because at this point the frame buffer content is up to date.

This requires the application to use either the multi-buffering or the cache lock/unlock function of emWin. A more sophisticated application using the window manager can handle this automatically. If the application runs without the window manager, the user must ensure that the following are called before and after drawing operations.

```
LCD_ControlCache(LCD_CC_LOCK);  
//  
// Do your drawings, then unlock again.  
//  
// ...  
LCD_ControlCache(LCD_CC_UNLOCK);
```

## 5.4 SVG support in browsers

It is possible to render SVGs in applications that are compiled with emWin4Web. This is achieved with NanoVG and the NanoVG driver of emWin's SVG module. To enable SVG support, the option `--svg` has to be passed to emWin4Web.

Since NanoVG uses OpenGL ES 2.0 as its rendering backend, Emscripten will convert these calls into WebGL which allows for fast vector graphics in a browser environment.

### Limitations

However, with the above described approach there are a few limitations:

- Rendering to Memory Devices is not possible, SVGs can only be directly rendered to the frame buffer.
- `GUICC_8888I` is required as the color conversion of the application.
- Because NanoVG is used, possible limitations of `GUI_SVG_DRIVER_NANOVG` apply here too. See the chapter *SVGLimitations* on page 524.

## 5.5 GUI\_EMSCRIPTEN API

emWin offers some utility functions which are intended for usage when compiling with Emscripten. This API is described here.

### Note

All the below functions will compile when emWin is **not** compiled with Emscripten, but they will not do anything.

### Functions

Function	Description
<a href="#">GUI_EMSCRIPTEN_GetNow()</a>	Retrieves the current date via JavaScript.
<a href="#">GUI_EMSCRIPTEN_GetNowTimezone()</a>	Retrieves the current date via JavaScript of a given timezone.

## 5.5.1 GUI\_EMSCRIPTEN\_GetNow()

### Description

Retrieves the current date via JavaScript.

### Prototype

```
void GUI_EMSCRIPTEN_GetNow(GUI_EMSCRIPTEN_DATE * pDate);
```

### Parameters

Parameter	Description
<code>pDate</code>	<code>out</code> Current date.

### Additional information

**Note:** This function does nothing when emWin is not compiled with Emscripten.

## 5.5.2 GUI\_EMSCRIPTEN\_GetNowTimezone()

### Description

Retrieves the current date via JavaScript of a given timezone. Under the hood, the method `toLocaleString()` of a JavaScript `Date` object is called.

### Prototype

```
void GUI_EMSCRIPTEN_GetNowTimezone(      GUI_EMSCRIPTEN_DATE * pDate,
                                       const char          * sTimezone);
```

### Parameters

Parameter	Description
<code>pDate</code>	<b>out</b> Current date.
<code>sTimezone</code>	<b>in</b> String with timezone identifier to query the current time. <code>sTimezone</code> must be a valid match for the <code>timeZone</code> parameter of <code>toLocaleString()</code> .

### Additional information

**Note:** This function does nothing when `emWin` is not compiled with Emscripten.

### Data structures

Data structure	Description
<code>GUI_EMSCRIPTEN_DATE</code>	Retrieves the current date via JavaScript of a given timezone.



# Chapter 6

## Basic features

---

The following chapter contains all basic emWin features. These features are all part of the **emWin BASE package**.

- Displaying Text
- Displaying Values
- 2-D Graphic Library
- Displaying bitmap files
- Displaying Scalable Vector Graphics (SVG) files
- Colors
- Fonts
- Animations
- Movies
- Pointer Input Devices
- Info about screen changes
- Multiple Buffering
- Keyboard Input
- Language Support
- Timing- and execution-related functions

## 6.1 Displaying Text

It is very easy to display text with emWin. Knowledge of only a few routines already allows you to write any text, in any available font, at any point on the display. We first provide a short introduction to displaying text, followed by more detailed descriptions of the individual routines that are available.

### 6.1.1 Basic routines

Text can be displayed just by calling `GUI_DispString()`. For example:

```
GUI_DispString("Hello world!");
```

The above code will display the text "Hello world" at the current text position. However, there are functions to display text using different fonts or at certain positions. Even when using byte-oriented displays the position can be specified pixel accurate. In addition to that, it is also possible to display decimal, hexadecimal and binary values. Details on how values can be displayed using emWin can be found in the chapter *Displaying Values* on page 291.

#### Control characters

Control characters are characters with a character code of less than 32. The control characters are defined as part of ASCII. emWin ignores all control characters except the following:

Char. Code	ASCII code	C	Description
10	LF	\n	Line feed. The current text position is changed to the beginning of the next line. Per default, this is: X = 0. Y += font-distance in pixels (as delivered by <code>GUI_GetFontDistY()</code> ).

#### Note

emWin does not interpret carriage return (\r) characters! Only new line characters (\n) should be used to display text in a new line!

## 6.1.2 Drawing modes

Text is displayed using the foreground and background color which are set using the functions `GUI_SetColor()` and `GUI_SetBkColor()` described below. In order to set a certain drawing mode to display strings or single characters the function `GUI_SetTextMode()` can be called using the flags described below.

### Normal text

Displaying normal text is the default behavior. The characters are displayed using the foreground color. The background color is used to clear the background according to its width of the text and height of the currently selected font. Text can be displayed normally by specifying just `GUI_TM_NORMAL` or 0.

### Reverse text

Text can be displayed in reverse mode by specifying `GUI_TM_REV`. This causes characters to be displayed using the background color and the background to be cleared using the foreground color.

### Transparent text

Text can be displayed in transparent mode by specifying `GUI_TM_TRANS`. This causes characters to be displayed without the background to be cleared. In this case whatever was drawn before the text was displayed can still be seen.

### XOR text

Text can be displayed in XOR mode by specifying `GUI_TM_XOR`. This causes characters to be displayed using the inverted colors of the background. This is done pixel-wise. This is also a transparent drawing mode, so the background remains unchanged. This mode is often used to in 1bpp-configurations to ensure readability, since black is inverted to white and vice versa. In case colors are used a single pixel is inverted as follows:

```
New pixel color = number of colors - actual pixel color - 1
```

### Transparent reversed text

Text can be displayed in reverse and transparent mode by specifying `(GUI_TM_TRANS | GUI_TM_REV)`. According to the transparent mode, the background is not cleared. According to the reverse mode, the characters are displayed using the background color.

### Example

Displays normal, reverse, transparent, XOR, and transparent reversed text:

```
GUI_SetFont(&GUI_Font8x16);
GUI_SetBkColor(GUI_BLUE);
GUI_Clear();
GUI_SetPenSize(10);
GUI_SetColor(GUI_RED);
GUI_DrawLine(80, 10, 240, 90);
GUI_DrawLine(80, 90, 240, 10);
GUI_SetBkColor(GUI_BLACK);
GUI_SetColor(GUI_WHITE);
GUI_SetTextMode(GUI_TM_NORMAL);
GUI_DispStringHCenterAt("GUI_TM_NORMAL", 160, 10);
GUI_SetTextMode(GUI_TM_REV);
GUI_DispStringHCenterAt("GUI_TM_REV", 160, 26);
GUI_SetTextMode(GUI_TM_TRANS);
GUI_DispStringHCenterAt("GUI_TM_TRANS", 160, 42);
GUI_SetTextMode(GUI_TM_XOR);
GUI_DispStringHCenterAt("GUI_TM_XOR", 160, 58);
GUI_SetTextMode(GUI_TM_TRANS | GUI_TM_REV);
```

```
GUI_DispStringHCenterAt("GUI_TM_TRANS | GUI_TM_REV", 160, 74);
```

### Screenshot of above example



### 6.1.3 Position

Every task has a current text position. This is the position relative to the origin of the display. This position is used by text displaying functions to place the next characters. Initially this position is (0,0) which is the upper left corner of the display. When using the Window Manager the position is used according to the current window. In order to set the text position the function `GUI_GotoX()`, `GUI_GotoY()` and `GUI_GotoXY()` can be used.

## 6.1.4 Text API

The table below lists the available text-related functions in alphabetical order within their respective categories. Detailed function descriptions can be found in the following sections.

### Functions

Routine	Description
Displaying text	
<code>GUI_DispCEOL()</code>	Clears the current line from the current position to the end.
<code>GUI_DispChar()</code>	Displays a single character.
<code>GUI_DispCharAt()</code>	Displays a single character at the specified position.
<code>GUI_DispChars()</code>	Displays a character a specified number of times.
<code>GUI_DispString()</code>	Displays a string.
<code>GUI_DispStringAt()</code>	Displays a string at the specified position.
<code>GUI_DispStringAtCEOL()</code>	Displays a string at the specified position and clears the current line to the end.
<code>GUI_DispStringHCenterAt()</code>	Displays a string centered horizontally at the given position.
<code>GUI_DispStringInRect()</code>	Displays a string in the specified rectangle.
<code>GUI_DispStringInRectEx()</code>	Displays a string rotated in the specified rectangle.
<code>GUI_DispStringInRectWrap()</code>	Displays a string wrapped in the specified rectangle.
<code>GUI_DispStringInRectWrapEx()</code>	Displays a string rotated and wrapped in the specified rectangle.
<code>GUI_DispStringLength()</code>	Displays a string at the current position with specified number of characters.
<code>GUI_GetCharFromPos()</code>	Returns a character from a string at a given X-position in the current font.
<code>GUI_GetShowMissingCharacters()</code>	Returns if showing of missing characters is enabled or not.
<code>GUI_ShowMissingCharacters()</code>	This function enables displaying of missing characters.
<code>GUI_WrapGetNumLines()</code>	Returns the number of lines required to display the given text with the given wrap mode at the given size using the current font.
<code>GUI_WrapGetPositions()</code>	Calculates the wrapping positions of a string.
<code>GUI_WrapSetSeparators()</code>	Allows to set an array of additional characters that are used for displaying wrapped strings.
Drawing modes	
<code>GUI_GetTextMode()</code>	Returns the currently selected text mode.
<code>GUI_SetClearTextRectMode()</code>	Enables or disables the clear text rect mode.
<code>GUI_SetTextMode()</code>	Sets the text mode to the parameter specified.
<code>GUI_SetTextStyle()</code>	Sets the text style to the parameter specified.
Alignment	
<code>GUI_GetTextAlign()</code>	Returns the current text alignment mode.

Routine	Description
<code>GUI_SetLBorder()</code>	Sets the left border for line feeds in the current window.
<code>GUI_SetTextAlign()</code>	Sets the text alignment.
Position	
<code>GUI_DispNextLine()</code>	Moves the cursor to the beginning of the next line.
<code>GUI_GotoX()</code>	Sets the X-position.
<code>GUI_GotoXY()</code>	Sets the X- and Y-position.
<code>GUI_GotoY()</code>	Sets the Y-position.
<code>GUI_GetDispPosX()</code>	Returns the current X-position.
<code>GUI_GetDispPosY()</code>	Returns the current Y-position.

## Defines

Group of defines	Description
<code>Text alignment flags</code>	Define the alignment of a text.
<code>Text drawing modes</code>	Define with which mode a text will be drawn.
<code>Text rotation modes</code>	Rotate the text.
<code>Text style flags</code>	Text style how a text will be displayed.

## Enumerations

Enumeration type	Description
<code>GUI_WRAPMODE</code>	Configuration how text will be wrapped.

## 6.1.4.1 Displaying text

### 6.1.4.1.1 GUI\_DispCEOL()

#### Description

Clears the current line in the current window (or the display) from the current text position to the end of the window using the height of the current font.

#### Prototype

```
void GUI_DispCEOL(void);
```

#### Example

Shows "Hello world" on the display, waits 1 second and then displays "Hi" in the same place, replacing the old string:

```
GUI_DispStringAt("Hello world", 0, 0);  
GUI_Delay(1000);  
GUI_DispStringAt("Hi", 0, 0);  
GUI_DispCEOL();
```



### 6.1.4.1.2 GUI\_Dispatch()

#### Description

Displays a single character at the current text position in the current window using the current font.

#### Prototype

```
void GUI_Dispatch(U16 c);
```

#### Parameters

Parameter	Description
c	Character to display

#### Additional information

This is the basic routine for displaying a single character. All other display routines (`GUI_DispatchAt()`, `GUI_DispatchString()`, etc.) call this routine to output the individual characters. Which characters are available depends on the selected font. If the character is not available in the current font, nothing is displayed.

#### Example

Shows a capital A on the display:

```
GUI_Dispatch('A');
```

#### Related topics

- *GUI\_DispatchChars* on page 259
- *GUI\_DispatchAt* on page 258

### 6.1.4.1.3 GUI\_DispatchAt()

#### Description

Displays a single character at the specified position in the current window using the current font.

#### Prototype

```
void GUI_DispatchAt(U16 c,  
                  I16P x,  
                  I16P y);
```

#### Parameters

Parameter	Description
<code>c</code>	Character to display
<code>x</code>	X-position to write to in pixels of the client window.
<code>y</code>	Y-position to write to in pixels of the client window.

#### Additional information

Displays the character with its upper left corner at the specified (X,Y) position. Writes the character using the routine `GUI_Dispatch()`. If the character is not available in the current font, nothing is displayed.

#### Example

Shows a capital A on the display in the upper left corner:

```
GUI_DispatchAt('A',0,0);
```

#### Related topics

- [GUI\\_Dispatch](#) on page 257
- [GUI\\_DispatchChars](#) on page 259

### 6.1.4.1.4 GUI\_DisChars()

#### Description

Displays a character a specified number of times at the current text position in the current window using the current font.

#### Prototype

```
void GUI_DisChars(U16P c,
                 int NumChars);
```

#### Parameters

Parameter	Description
c	Character to display
Cnt	Number of repetitions ( $0 \leq \text{Cnt} \leq 32767$ ).

#### Additional information

Writes the character using the routine `GUI_DisChar()` . If the character is not available in the current font, nothing is displayed.

#### Example

Shows the line `*****` on the display:

```
GUI_DisChars('*', 30);
```

#### Related topics

- `GUI_DisChar` on page 257
- `GUI_DisCharAt` on page 258

### 6.1.4.1.5 GUI\_DispString()

#### Description

Displays the string passed as parameter at the current text position in the current window using the current font.

#### Prototype

```
void GUI_DispString(const char * s);
```

#### Parameters

Parameter	Description
s	String to display

#### Additional information

The string can contain the control character `\n`. This control character moves the current text position to the beginning of the next line.

#### Example

Shows "Hello world" on the display and "Next line" on the next line:

```
GUI_DispString("Hello world"); //Disp text  
GUI_DispString("\nNext line"); //Disp text
```

#### Related topics

- [GUI\\_DispStringAt](#) on page 261
- [GUI\\_DispStringAtCEOL](#) on page 262
- [GUI\\_DispStringLen](#) on page 268

### 6.1.4.1.6 GUI\_DispStringAt()

#### Description

Displays the string passed as parameter at a specified position in the current window using the current font.

#### Prototype

```
void GUI_DispStringAt(const char * s,  
                     int x,  
                     int y);
```

#### Parameters

Parameter	Description
<code>s</code>	String to display
<code>x</code>	X-position to write to in pixels of the client window.
<code>y</code>	Y-position to write to in pixels of the client window.

#### Example

Shows "Position 50,20" at position 50,20 on the display:

```
GUI_DispStringAt("Position 50,20", 50, 20); // Disp text
```

#### Related topics

- [GUI\\_DispString](#) on page 260
- [GUI\\_DispStringAtCEOL](#) on page 262
- [GUI\\_DispStringLength](#) on page 268

### 6.1.4.1.7 GUI\_DisStringAtCEOL()

#### Description

Displays a given string at a specified position and clearing the remaining part of the line to the end by calling the routine `GUI_DispCEOL()`. This routine can be handy if one string is to overwrite another, and the overwriting string is or may be shorter than the previous one.

#### Prototype

```
void GUI_DisStringAtCEOL(const char * s,  
                        int x,  
                        int y);
```

#### Parameters

Parameter	Description
<code>s</code>	String to display
<code>x</code>	X-position to write to in pixels of the client window.
<code>y</code>	Y-position to write to in pixels of the client window.

### 6.1.4.1.8 GUI\_DispStringHCenterAt()

#### Description

Displays the string passed as parameter horizontally centered at a specified position in the current window using the current font.

#### Prototype

```
void GUI_DispStringHCenterAt(const char * s,  
                             int      x,  
                             int      y);
```

#### Parameters

Parameter	Description
<code>s</code>	String to display
<code>x</code>	X-position to write to in pixels of the client window.
<code>y</code>	Y-position to write to in pixels of the client window.

### 6.1.4.1.9 GUI\_DispStringInRect()

#### Description

Displays the string passed as parameter at a specified position within a specified rectangle, in the current window using the current font.

#### Prototype

```
void GUI_DispStringInRect(const char * pText,
                        GUI_RECT * pRect,
                        int TextAlign);
```

#### Parameters

Parameter	Description
<code>s</code>	String to display
<code>pRect</code>	Rectangle to write to in pixels of the client window.
<code>TextAlign</code>	Text alignment mode to set. List of flags can be found under <i>Text alignment flags</i> on page 286.

#### Additional information

If the specified rectangle is too small, the text will be clipped.

#### Example

Shows the word "Text" centered horizontally and vertically in the current window:

```
GUI_RECT rClient;
GUI_GetClientRect(&rClient);
GUI_DispStringInRect("Text", &rClient, GUI_TA_HCENTER | GUI_TA_VCENTER);
```

#### Related topics

- [GUI\\_DispString](#) on page 260
- [GUI\\_DispStringAtCEOL](#) on page 262
- [GUI\\_DispStringLength](#) on page 268



### 6.1.4.1.10 GUI\_DispStringInRectEx()

#### Description

Displays the string passed as parameter at a specified position within a specified rectangle, in the current window using the current font and (optionally) rotates it.

#### Prototype

```
void GUI_DispStringInRectEx(const char      * s,
                           GUI_RECT      * pRect,
                           int           TextAlign,
                           int           MaxLen,
                           const GUI_ROTATION * pLCD_Api);
```

#### Parameters

Parameter	Description
<code>s</code>	String to display
<code>pRect</code>	Rectangle to write to in pixels of the client window.
<code>TextAlign</code>	Text alignment mode. List of flags can be found under <i>Text alignment flags</i> on page 286.
<code>MaxLen</code>	Maximum number of characters to be shown.
<code>pLCD_Api</code>	Text rotation mode. See full list of available values under <i>Text rotation modes</i> on page 288.

#### Additional information

If the specified rectangle is too small, the text will be clipped. To make the function available the configuration switch `GUI_SUPPORT_ROTATION` must be activated (default).

#### Example

Shows the word "Text" centered horizontally and vertically in the given rectangle:

```
GUI_RECT Rect = {10, 10, 40, 80};
char acText[] = "Rotated\ntext";
GUI_SetTextMode(GUI_TM_XOR);
GUI_FillRectEx(&Rect);
GUI_DispStringInRectEx(acText, &Rect, GUI_TA_HCENTER | GUI_TA_VCENTER,
                       strlen(acText), GUI_ROTATE_CCW);
```

#### Screenshot of above example



### 6.1.4.1.11 GUI\_DispStringInRectWrap()

#### Description

Displays a string at a specified position within a specified rectangle, in the current window using the current font and (optionally) wraps the text.

#### Prototype

```
void GUI_DispStringInRectWrap(const char * s,
                             GUI_RECT * pRect,
                             int TextAlign,
                             GUI_WRAPMODE WrapMode);
```

#### Parameters

Parameter	Description
<code>s</code>	String to display
<code>pRect</code>	Rectangle to write to in pixels of the client window.
<code>TextAlign</code>	Text alignment mode. List of flags can be found under <i>Text alignment flags</i> on page 286.
<code>WrapMode</code>	Text wrap mode. See full list of available values under <i>GUI_WRAPMODE</i> on page 290.

#### Example

Shows a text centered horizontally and vertically in the given rectangle with word wrapping:

```
GUI_WRAPMODE aWm[]
= { GUI_WRAPMODE_NONE, GUI_WRAPMODE_CHAR, GUI_WRAPMODE_WORD};
GUI_RECT Rect = {10, 10, 59, 59};
char acText[] = "This example demonstrates text wrapping";
int i;
GUI_SetTextMode(GUI_TM_TRANS);
for (i = 0; i < 3; i++) {
    GUI_SetColor(GUI_BLUE);
    GUI_FillRectEx(&Rect);
    GUI_SetColor(GUI_WHITE);
    GUI_DispStringInRectWrap(acText, &Rect, GUI_TA_LEFT, aWm[i]);
    Rect.x0 += 60;
    Rect.x1 += 60;
}
```

#### Screenshot of above example



### 6.1.4.1.12 GUI\_DispStringInRectWrapEx()

#### Description

Displays a string rotated at a specified position within a specified rectangle, in the current window using the current font and (optionally) wraps the text.

#### Prototype

```
void GUI_DispStringInRectWrapEx(const char      * s,
                               GUI_RECT      * pRect,
                               int           TextAlign,
                               GUI_WRAPMODE  WrapMode,
                               const GUI_ROTATION * pLCD_Api);
```

#### Parameters

Parameter	Description
<code>s</code>	String to display.
<code>pRect</code>	Rectangle to write to in pixels of the client window.
<code>TextAlign</code>	Text alignment mode. List of flags can be found under <i>Text alignment flags</i> on page 286.
<code>WrapMode</code>	Text wrap mode. See full list of available values under <i>GUI_WRAPMODE</i> on page 290.
<code>pLCD_Api</code>	Text rotation mode. See full list of available values under <i>Text rotation modes</i> on page 288.

### 6.1.4.1.13 GUI\_DispStringLen()

#### Description

Displays the string passed as parameter with a specified number of characters at the current text position, in the current window using the current font.

#### Prototype

```
void GUI_DispStringLen(const char * s,  
                      int      MaxNumChars);
```

#### Parameters

Parameter	Description
<a href="#">s</a>	Should be a terminated array of 8-bit characters. Passing NULL as parameter is permitted.
<a href="#">MaxNumChars</a>	Number of characters to display.

#### Additional information

If the string has less characters than specified (is shorter), it is padded with spaces. If the string has more characters than specified (is longer), then only the given number of characters is actually displayed. This function is especially useful if text messages can be displayed in different languages (and will naturally differ in length), but only a certain number of characters can be displayed.

#### Related topics

- [GUI\\_DispString](#) on page 260
- [GUI\\_DispStringAt](#) on page 261
- [GUI\\_DispStringAtCEOL](#) on page 262

#### 6.1.4.1.14 GUI\_GetCharFromPos()

##### Description

Returns a character from a string at a given X-position in the current font.

##### Prototype

```
U16 GUI_GetCharFromPos(const char * pText ,  
                      int x,  
                      int * pIndex);
```

##### Parameters

Parameter	Description
<code>pText</code>	Pointer to a string.
<code>x</code>	X-position in pixels in the string.
<code>pIndex</code>	Pointer to int. Zero-based position of the character in the string. Can be <code>NULL</code> if not needed.

##### Return value

= 0      No character found.  
≠ 0      Character at the given X-position in a string.

##### Additional information

The function assumes the text begins at `x = 0`. Notice also that a font has to have been set that contains the characters in the given string.

#### 6.1.4.1.15 GUI\_GetShowMissingCharacters()

##### Description

Returns if showing of missing characters is enabled or not.

##### Prototype

```
int GUI_GetShowMissingCharacters(void);
```

##### Return value

1	If enabled.
0	If not enabled.

#### 6.1.4.1.16 GUI\_ShowMissingCharacters()

##### Description

This function enables displaying of missing characters.

##### Prototype

```
void GUI_ShowMissingCharacters(int OnOff);
```

##### Parameters

Parameter	Description
OnOff	Enables (1) or disables (0) displaying of missing characters.

##### Additional information

If a font does not contain a character to be displayed emWin skips this character. By calling this function a square gets displayed instead of the missing character.

### 6.1.4.1.17 GUI\_WrapGetNumLines()

#### Description

Returns the number of lines required to display the given text with the given wrap mode at the given size using the current font.

#### Prototype

```
int GUI_WrapGetNumLines(const char * pText,
                        int xSize,
                        GUI_WRAPMODE WrapMode);
```

#### Parameters

Parameter	Description
<code>pText</code>	String to display. Should be a \0-terminated array of 8-bit characters.
<code>xSize</code>	X-size to be used to draw the text.
<code>WrapMode</code>	See table below.

#### Return value

The number of lines which is required to display the given text.



### 6.1.4.1.18 GUI\_WrapGetPositions()

#### Description

Calculates the wrapping positions of a string. This function does not render the string but only calculates the wrapping positions within the string (in bytes) and the number of resulting lines.

#### Prototype

```
int GUI_WrapGetPositions(const char * pText,
                        int xSize,
                        GUI_WRAPMODE WrapMode,
                        int * aPos,
                        int NumItems);
```

#### Parameters

Parameter	Description
<code>pText</code>	<b>in</b> Pointer to a zero-terminated string.
<code>xSize</code>	Horizontal size of the rectangle the string <code>pText</code> is to be displayed in.
<code>WrapMode</code>	Wrap mode to be used, see <code>GUI_WRAPMODE</code> .
<code>aPos</code>	<b>out</b> Pointer to an int array where the byte wrapping positions will be written to.
<code>NumItems</code>	Number of items available in the array pointed to by <code>aPos</code> .

#### Return value

Number of lines.

### 6.1.4.1.19 GUI\_WrapSetSeparators()

#### Description

Allows to set an array of additional characters that are used for displaying wrapped strings.

#### Prototype

```
void GUI_WrapSetSeparators(const U16 * pSep,  
                           int NumSeps);
```

#### Parameters

Parameter	Description
<code>pSep</code>	<code>in</code> Pointer to an array of U16 containing the characters to be used during word wrapping.
<code>NumSeps</code>	Number of items in the array pointed to by <code>pSep</code> .

#### Additional information

One use-case would be to add the zero-width space (ZWSP) to the separators (0x200B). The ZWSP can be used to e.g. separate words in a Chinese string.

## 6.1.4.2 Drawing modes

### 6.1.4.2.1 GUI\_GetTextMode()

#### Description

Returns the currently selected text mode.

#### Prototype

```
int GUI_GetTextMode(void);
```

#### Return value

The currently selected text mode.

### 6.1.4.2.2 GUI\_SetClearTextRectMode()

#### Description

Enables or disables the clear text rect mode.

#### Prototype

```
U8 GUI_SetClearTextRectMode(unsigned OnOff);
```

#### Parameters

Parameter	Description
OnOff	Enables or disable the clear text rect mode.

#### Return value

The previous selected mode.

#### Additional information

If the clear text rect mode is enabled the rectangular area when using `GUI_DispStringInRect()` gets cleared with the given background color.

### 6.1.4.2.3 GUI\_SetTextMode()

#### Description

Sets the text mode to the parameter specified.

#### Prototype

```
int GUI_SetTextMode(int Mode);
```

#### Parameters

Parameter	Description
Mode	Text mode. See full list of available values under <i>Text drawing modes</i> on page 287.

#### Return value

The previous selected text mode.

#### Additional information

Please note that GUI\_TM\_XOR can not be used with antialiased fonts.

#### 6.1.4.2.4 GUI\_SetTextStyle()

##### Description

Sets the text style to the parameter specified.

##### Prototype

```
char GUI_SetTextStyle(char Style);
```

##### Parameters

Parameter	Description
<code>Style</code>	Text style to set. See full list of available values under <i>Text style flags</i> on page 289.

##### Return value

The previous selected text style.

### 6.1.4.3 Alignment

#### 6.1.4.3.1 GUI\_GetTextAlign()

##### Description

Returns the current text alignment mode.

##### Prototype

```
int GUI_GetTextAlign(void);
```

##### Return value

The current text alignment mode.

### 6.1.4.3.2 GUI\_SetLBorder()

#### Description

Sets the left border for line feeds in the current window.

#### Prototype

```
int GUI_SetLBorder(int x);
```

#### Parameters

Parameter	Description
<code>x</code>	New left border (in pixels, 0 is left border).



### 6.1.4.3.3 GUI\_SetTextAlign()

#### Description

Sets the text alignment for the next displayed string in the current window.

#### Prototype

```
int GUI_SetTextAlign(int Align);
```

#### Parameters

Parameter	Description
<code>TextAlign</code>	Text alignment mode to set. List of flags can be found under <i>Text alignment flags</i> on page 286.

#### Return value

The selected text alignment mode.

#### Additional information

Setting the text alignment does not affect `GUI_DispChar...()`-functions. Text alignment is valid only for the current window.

#### Example

Displays the value 1234 with the center of the text at  $x = 100$ ,  $y = 100$ :

```
GUI_SetTextAlign(GUI_TA_HCENTER | GUI_TA_VCENTER);  
GUI_DispDecAt(1234, 100, 100, 4);
```

## 6.1.4.4 Position

### 6.1.4.4.1 GUI\_DispNextLine()

#### Description

Moves the cursor to the beginning of the next line which can be adjusted using the function `GUI_SetLBorder()`.

#### Prototype

```
void GUI_DispNextLine(void);
```

#### 6.1.4.4.2 GUI\_GotoXY()

#### 6.1.4.4.3 GUI\_GotoX()

#### 6.1.4.4.4 GUI\_GotoY()

### Description

Set the current text write position.

### Prototypes

```
char GUI_GotoXY(int x,  
               int y);
```

```
char GUI_GotoX(int x);
```

```
char GUI_GotoY(int y);
```

### Parameters

Parameter	Description
y	New Y-position (in pixels, 0 is top border).

### Return value

= 0 on success.

≠ 0 if the set text position is right or below outside the window. Consecutive drawing operations can be omitted in this case.

### Example

Shows a string at position (20, 20) on the display:

```
GUI_GotoXY(20,20);  
GUI_DispString("The value is");
```

#### 6.1.4.4.5 GUI\_GetDispPosX()

##### Description

Returns the current X-position.

##### Prototype

```
int GUI_GetDispPosX(void);
```

##### Return value

The current X-position.

#### 6.1.4.4.6 GUI\_GetDispPosY()

##### Description

Returns the current Y-position.

##### Prototype

```
int GUI_GetDispPosY(void);
```

##### Return value

The current Y-position.

## 6.1.4.5 Defines

### 6.1.4.5.1 Text alignment flags

#### Description

Define the alignment of a text. Horizontal and vertical flags are OR-combinable.

#### Definition

```
#define GUI_TA_LEFT      (0)
#define GUI_TA_HCENTER  (2 << 0)
#define GUI_TA_RIGHT    (1 << 0)
#define GUI_TA_TOP      (0)
#define GUI_TA_VCENTER  (3 << 2)
#define GUI_TA_BOTTOM   (1 << 2)
```

#### Symbols

Definition	Description
Horizontal alignment	
<a href="#">GUI_TA_LEFT</a>	Align X-position left (default).
<a href="#">GUI_TA_HCENTER</a>	Center X-position.
<a href="#">GUI_TA_RIGHT</a>	Align X-position right.
Vertical alignment	
<a href="#">GUI_TA_TOP</a>	Align Y-position with top of characters (default).
<a href="#">GUI_TA_VCENTER</a>	Center Y-position.
<a href="#">GUI_TA_BOTTOM</a>	Align Y-position with bottom pixel line of font.

### 6.1.4.5.2 Text drawing modes

#### Description

These flags define with which mode a text will be drawn. These flags are OR-combinable.

#### Definition

```
#define GUI_TM_NORMAL      (0)
#define GUI_TM_XOR        (1 << 0)
#define GUI_TM_TRANS      (1 << 1)
#define GUI_TM_REV        (1 << 2)
```

#### Symbols

Definition	Description
<a href="#">GUI_TM_NORMAL</a>	Default mode, characters are displayed using the foreground color, background color is used to clear the background according to width and height of the text.
<a href="#">GUI_TM_XOR</a>	Characters are displayed using the inverted colors of the background (pixel-wise).
<a href="#">GUI_TM_TRANS</a>	Characters are displayed without the background being cleared.
<a href="#">GUI_TM_REV</a>	Characters are displayed using the background color, foreground color is used to clear the background according to width and height of the text.

#### Additional information

More information about text drawing modes can be found under Drawing modes.

### 6.1.4.5.3 Text rotation modes

#### Description

These macros are necessary for text rotation. They are used for example by the function `GUI_DispStringInRectEx()`.

#### Definition

```
#define GUI_ROTATE_0      0
#define GUI_ROTATE_180   &LCD_APIList180
#define GUI_ROTATE_CW    &LCD_APIListCW
#define GUI_ROTATE_CCW   &LCD_APIListCCW
```

#### Symbols

Definition	Description
<a href="#">GUI_ROTATE_0</a>	Does not rotate the text. Shows it from left to right.
<a href="#">GUI_ROTATE_180</a>	Rotates the text by 180 degrees.
<a href="#">GUI_ROTATE_CW</a>	Rotates the text clockwise.
<a href="#">GUI_ROTATE_CCW</a>	Rotates the text counter clockwise.



#### 6.1.4.5.4 Text style flags

##### Description

Text style how a text will be displayed.

##### Definition

```
#define GUI_TS_NORMAL          (0)
#define GUI_TS_UNDERLINE      (1 << 0)
#define GUI_TS_STRIKETHRU     (1 << 1)
#define GUI_TS_OVERLINE       (1 << 2)
```

##### Symbols

Definition	Description
<a href="#">GUI_TS_NORMAL</a>	Renders text normal (default).
<a href="#">GUI_TS_UNDERLINE</a>	Renders text underlined.
<a href="#">GUI_TS_STRIKETHRU</a>	Renders text in strike through type.
<a href="#">GUI_TS_OVERLINE</a>	Renders text in overline type.

## 6.1.4.6 Enumerations

### 6.1.4.6.1 GUI\_WRAPMODE

#### Description

Configuration how text will be wrapped.

#### Type definition

```
typedef enum {  
    GUI_WRAPMODE_NONE,  
    GUI_WRAPMODE_WORD,  
    GUI_WRAPMODE_CHAR  
} GUI_WRAPMODE;
```

#### Enumeration constants

Constant	Description
<a href="#">GUI_WRAPMODE_NONE</a>	No wrapping will be performed.
<a href="#">GUI_WRAPMODE_WORD</a>	Text is wrapped word wise.
<a href="#">GUI_WRAPMODE_CHAR</a>	Text is wrapped char wise.

#### Additional information

If word wrapping should be performed and the given rectangle is too small for a word, char wrapping is executed at this word.

## 6.2 Displaying Values

The preceding chapter explained how to show strings on the display. Of course you may use strings and the functions of the standard C library to display values. However, this can sometimes be a difficult task. It is usually much easier (and much more efficient) to call a routine that displays the value in the form that you want. emWin supports different decimal, hexadecimal and binary outputs. The individual routines are explained in this chapter.

All functions work without the usage of a floating-point library and are optimized for both speed and size. Of course `sprintf()` may also be used on any system. Using the routines in this chapter can sometimes simplify things and save both ROM space and execution time.

## 6.2.1 Value API

The table below lists the available value-related routines in alphabetical order within their respective categories. Detailed descriptions of the routines can be found in the sections that follow.

Routine	Description
Displaying decimal values	
<code>GUI_DispDec()</code>	Displays the given value in decimal form with the specified number of characters.
<code>GUI_DispDecAt()</code>	Displays the given value in decimal form at the specified position with specified number of characters.
<code>GUI_DispDecMin()</code>	Displays the given value in decimal form with minimum number of characters.
<code>GUI_DispDecShift()</code>	Displays long value in decimal form with decimal point at current position with specified number of characters.
<code>GUI_DispDecSpace()</code>	Display value in decimal form at current position with specified number of characters, replace leading zeros with spaces.
<code>GUI_DispSDec()</code>	Display value in decimal form at current position with specified number of characters and sign.
<code>GUI_DispSDecShift()</code>	Display long value in decimal form with decimal point at current position with specified number of characters and sign.
Displaying floating-point values	
<code>GUI_DispFloat()</code>	Display floating-point value with specified number of characters.
<code>GUI_DispFloatFix()</code>	Display floating-point value with fixed no. of digits to the right of decimal point.
<code>GUI_DispFloatMin()</code>	Display floating-point value with minimum number of characters.
<code>GUI_DispSFloatFix()</code>	Display floating-point value with fixed no. of digits to the right of decimal point and sign.
<code>GUI_DispSFloatMin()</code>	Display floating-point value with minimum number of characters and sign.
Displaying binary values	
<code>GUI_DispBin()</code>	Display value in binary form at current position.
<code>GUI_DispBinAt()</code>	Display value in binary form at specified position.
Displaying hexadecimal values	
<code>GUI_DispHex()</code>	Display value in hexadecimal form at current position.
<code>GUI_DispHexAt()</code>	Display value in hexadecimal form at specified position.
Version of emWin	
<code>GUI_GetVersionString()</code>	Returns a string containing the current version of emWin.

## 6.2.1.1 Displaying decimal values

### 6.2.1.1.1 GUI\_DispDec()

#### Description

Displays a value in decimal form with a specified number of characters at the current text position, in the current window using the current font.

#### Prototype

```
void GUI_DispDec(I32 v,
                U8 Len);
```

#### Parameters

Parameter	Description
<code>v</code>	Value to display. Minimum -2147483648 (= $-2^{31}$ ). Maximum 2147483647 (= $2^{31} - 1$ ).
<code>Len</code>	Number of digits to display (max. 10).

#### Additional information

Leading zeros are not suppressed (are shown as 0). If the value is negative, a minus sign is shown.

#### Example

```
// Display time as minutes and seconds
GUI_DispString("Min:");
GUI_DispDec(Min, 2);
GUI_DispString(" Sec:");
GUI_DispDec(Sec, 2);
```

#### Related topics

- [GUI\\_DispSDec](#) on page 298
- [GUI\\_DispDecAt](#) on page 294
- [GUI\\_DispDecMin](#) on page 295
- [GUI\\_DispDecSpace](#) on page 297

### 6.2.1.1.2 GUI\_DisDecAt()

#### Description

Displays a value in decimal form with a specified number of characters at a specified position, in the current window using the current font.

#### Prototype

```
void GUI_DisDecAt(I32 v,
                 I16P x,
                 I16P y,
                 U8 Len);
```

#### Parameters

Parameter	Description
<code>v</code>	Value to display. Minimum -2147483648 (= $-2^{31}$ ). Maximum 2147483647 (= $2^{31} - 1$ ).
<code>x</code>	X-position to write to in pixels of the client window.
<code>y</code>	Y-position to write to in pixels of the client window.
<code>Len</code>	Number of digits to display (max. 10).

#### Additional information

Leading zeros are not suppressed (are shown as 0). If the value is negative, a minus sign is shown.

#### Example

```
// Update seconds in upper right corner
GUI_DisDecAT(Sec, 200, 0, 2);
```

#### Related topics

- *GUI\_DisDec* on page 293
- *GUI\_DisDecS* on page 298
- *GUI\_DisDecMin* on page 295
- *GUI\_DisDecSpace* on page 297

### 6.2.1.1.3 GUI\_DisDecMin()

#### Description

Displays a value in decimal form at the current text position in the current window using the current font. The length of the value does not require to be specified. The minimum length will automatically be used.

#### Prototype

```
void GUI_DisDecMin(I32 v);
```

#### Parameters

Parameter	Description
v	Value to display. Minimum -2147483648 (= $-2^{31}$ ). Maximum 2147483647 (= $2^{31} - 1$ ).

#### Additional information

The maximum number of displayed digits is 10. This function should not be used if values have to be aligned but differ in the number of digits. Try one of the functions which require specification of the number of digits to use in this case.

#### Example

```
// Show result
GUI_DisString("The result is :");
GUI_DisDecMin(Result);
```

#### Related topics

- *GUI\_DisDec* on page 293
- *GUI\_DisDecAt* on page 294
- *GUI\_DisSDec* on page 298
- *GUI\_DisDecSpace* on page 297

#### 6.2.1.1.4 GUI\_DisDecShift()

##### Description

Displays a long value in decimal form with a specified number of characters and with decimal point at the current text position, in the current window using the current font.

##### Prototype

```
void GUI_DisDecShift(I32 v,  
                    U8 Len,  
                    U8 Shift);
```

##### Parameters

Parameter	Description
<code>v</code>	Value to display. Minimum -2147483648 (= $-2^{31}$ ). Maximum 2147483647 (= $2^{31} - 1$ ).
<code>Len</code>	Number of digits to display (max. 10).
<code>Shift</code>	Number of digits to show to right of decimal point.

##### Additional information

Watch the maximum number of 9 characters (including sign and decimal point).



### 6.2.1.1.5 GUI\_DispaceSpace()

#### Description

Displays a long value in decimal form with a specified number of characters and with decimal point at the current text position, in the current window using the current font.

#### Prototype

```
void GUI_DispaceSpace(I32 v,
                     U8 MaxDigits);
```

#### Parameters

Parameter	Description
<code>v</code>	Value to display. Minimum -2147483648 (= $-2^{31}$ ). Maximum 2147483647 (= $2^{31} - 1$ ).
<code>MaxDigits</code>	Number of digits to display, including leading spaces. Maximum number of digits displayed is 10 (excluding leading spaces).

#### Additional information

If values have to be aligned but differ in the number of digits, this function is a good choice.

#### Example

```
// Show result
GUI_DispaceString("The result is :");
GUI_DispaceSpace(Result, 10);
```

#### Related topics

- [GUI\\_DispaceDec](#) on page 293
- [GUI\\_DispaceDecAt](#) on page 294
- [GUI\\_DispaceSDec](#) on page 298
- [GUI\\_DispaceDecMin](#) on page 295

### 6.2.1.1.6 GUI\_DispsDec()

#### Description

Displays a value in decimal form (with sign) with a specified number of characters at the current text position, in the current window using the current font.

#### Prototype

```
void GUI_DispsDec(I32 v,  
                 U8 Len);
```

#### Parameters

Parameter	Description
<a href="#">v</a>	Value to display. Minimum -2147483648 (= $-2^{31}$ ). Maximum 2147483647 (= $2^{31} - 1$ ).
<a href="#">Len</a>	Number of digits to display (max. 10).

#### Additional information

Leading zeros are not suppressed. This function is similar to `GUI_DispsDec`, but a sign is always shown in front of the value, even if the value is positive.

#### Related topics

- [GUI\\_DispsDec](#) on page 293
- [GUI\\_DispsDecAt](#) on page 294
- [GUI\\_DispsDecMin](#) on page 295
- [GUI\\_DispsDecSpace](#) on page 297

### 6.2.1.1.7 GUI\_DispsDecShift()

#### Description

Displays a long value in decimal form (with sign) with a specified number of characters and with decimal point at the current text position, in the current window using the current font.

#### Prototype

```
void GUI_DispsDecShift(I32 v,
                      U8 Len,
                      U8 Shift);
```

#### Parameters

Parameter	Description
<code>v</code>	Value to display. Minimum -2147483648 (= $-2^{31}$ ). Maximum 2147483647 (= $2^{31} - 1$ ).
<code>Len</code>	Number of digits to display. (max. 8, if <code>Shift</code> is set; max. 9, if <code>Shift</code> is not set)
<code>Shift</code>	Number of digits to show to right of decimal point.

#### Additional information

A sign is always shown in front of the value. Watch the maximum number of 9 characters (including sign and decimal point).

#### Example

```
long Value = 12345;

GUI_Init();
GUI_Clear();
GUI_SetFont(&GUI_Font8x8);
GUI_DispsStringAt("GUI_DispsDecShift:\n",0,0);
GUI_DispsDecShift(Value, 7, 3);
```

#### Screenshot of above example



```
GUI_DispsDecShift:
+12.345
```

## 6.2.1.2 Displaying floating point values

### 6.2.1.2.1 GUI\_DisFloat()

#### Description

Displays a floating point value with a specified number of characters at the current text position in the current window using the current font.

#### Prototype

```
void GUI_DisFloat(    float f,
                   char Len);
```

#### Parameters

Parameter	Description
<code>v</code>	Value to display. Minimum 1.2 E-38; maximum 3.4 E38.
<code>Len</code>	Number of digits to display. (max. 10).

#### Additional information

Leading zeros are suppressed. The decimal point counts as one character. If the value is negative, a minus sign is shown.

#### Example

```
// Shows different possibilities to display floating point values.
float f = 123.45678;

GUI_Clear();
GUI_SetFont(&GUI_Font8x8);
GUI_DisStringAt("GUI_DisFloat:\n", 0, 0);
GUI_DisFloat(f, 9);
GUI_GotoX(100);
GUI_DisFloat(-f, 9);
GUI_DisStringAt("GUI_DisFloatFix:\n", 0, 20);
GUI_DisFloatFix(f, 9, 2);
GUI_GotoX(100);
GUI_DisFloatFix(-f, 9, 2);
GUI_DisStringAt("GUI_DisSFloatFix:\n", 0, 40);
GUI_DisSFloatFix(f, 9, 2);
GUI_GotoX(100);
GUI_DisSFloatFix(-f, 9, 2);
GUI_DisStringAt("GUI_DisFloatMin:\n", 0, 60);
GUI_DisFloatMin(f, 3);
GUI_GotoX(100);
GUI_DisFloatMin(-f, 3);
GUI_DisStringAt("GUI_DisSFloatMin:\n", 0, 80);
GUI_DisSFloatMin(f, 3);
GUI_GotoX(100);
GUI_DisSFloatMin(-f, 3);
```

**Screenshot of above example**

```
GUI_DisFloat:  
123.45678      -123.4568  
GUI_DisFloatFix:  
000123.46      -00123.46  
GUI_DisSFloatFix:  
+00123.46      -00123.46  
GUI_DisFloatMin:  
123.457        -123.457  
GUI_DisSFloatMin:  
+123.457        -123.457
```

### 6.2.1.2.2 GUI\_DisFloatFix()

#### Description

Displays a floating-point value with specified number of total characters and a specified number of characters to the right of the decimal point, at the current text position in the current window using the current font.

#### Prototype

```
void GUI_DisFloatFix(    float f,  
                       char Len,  
                       char Decs);
```

#### Parameters

Parameter	Description
<code>v</code>	Value to display. Minimum 1.2 E-38; maximum 3.4 E38.
<code>Len</code>	Number of digits to display. (max. 10).
<code>Decs</code>	Number of digits to show to the right of the decimal point.

#### Additional information

Leading zeros are not suppressed. If the value is negative, a minus sign is shown.

### 6.2.1.2.3 GUI\_DisFloatMin()

#### Description

Displays a floating-point value with a minimum number of decimals to the right of the decimal point, at the current text position in the current window using the current font.

#### Prototype

```
void GUI_DisFloatMin(    float f,  
                       char Fract);
```

#### Parameters

Parameter	Description
<code>v</code>	Value to display. Minimum 1.2 E-38; maximum 3.4 E38.
<code>Fract</code>	Minimum number of characters to display.

#### Additional information

Leading zeros are suppressed. If the value is negative, a minus sign is shown. The length does not need to be specified. The minimum length will automatically be used. If values have to be aligned but differ in the number of digits, one of the "...Fix()" -functions should be used instead.

### 6.2.1.2.4 GUI\_DispsFloatFix()

#### Description

Displays a floating-point value (with sign) with a specified number of total characters and a specified number of characters to the right of the decimal point, in the current window using the current font.

#### Prototype

```
void GUI_DispsFloatFix(    float f,  
                          char Len,  
                          char Fract);
```

#### Parameters

Parameter	Description
<code>v</code>	Value to display. Minimum 1.2 E-38; maximum 3.4 E38.
<code>Len</code>	Number of digits to display (max. 10).
<code>Decs</code>	Number of digits to show to the right of the decimal point.

#### Additional information

Leading zeros are not suppressed. A sign is always shown in front of the value.



### 6.2.1.2.5 GUI\_DispsFloatMin()

#### Description

Displays a floating-point value (with sign) with a minimum number of decimals to the right of the decimal point, at the current text position in the current window using the current font.

#### Prototype

```
void GUI_DispsFloatMin(    float f,  
                        char Fract);
```

#### Parameters

Parameter	Description
<code>v</code>	Value to display. Minimum 1.2 E-38; maximum 3.4 E38.
<code>Fract</code>	Minimum number of digits to display.

#### Additional information

Leading zeros are suppressed. A sign is always shown in front of the value. The length does not need to be specified. The minimum length will automatically be used. If values have to be aligned but differ in the number of digits, one of the "...Fix()" -functions should be used instead.

## 6.2.1.3 Displaying binary values

### 6.2.1.3.1 GUI\_DispBin()

#### Description

Displays a value in binary form at the current text position in the current window using the current font.

#### Prototype

```
void GUI_DispBin(U32 v,  
                U8 Len);
```

#### Parameters

Parameter	Description
<code>v</code>	Value to display, 32-bit.
<code>Len</code>	Number of digits to display (including leading zeros).

#### Additional information

As with decimal and hexadecimal values, the least significant bit is rightmost.

#### Example

```
//  
// Show binary value 7, result: 000111  
//  
U32 Input = 0x7;  
GUI_DispBin(Input, 6);
```

#### Related topics

*GUI\_DispBinAt* on page 307

### 6.2.1.3.2 GUI\_DispBinAt()

#### Description

Displays a value in binary form at a specified position in the current window using the current font.

#### Prototype

```
void GUI_DispBinAt(U32 v,  
                  I16P x,  
                  I16P y,  
                  U8 Len);
```

#### Parameters

Parameter	Description
<a href="#">v</a>	Value to display, 32-bit.
<a href="#">x</a>	X-position to write to in pixels of the client window.
<a href="#">y</a>	Y-position to write to in pixels of the client window.
<a href="#">Len</a>	Number of digits to display (including leading zeros).

#### Additional information

As with decimal and hexadecimal values, the least significant bit is rightmost.

#### Example

```
//  
// Show binary input status  
//  
GUI_DispBinAt(Input, 0, 0, 8);
```

#### Related topics

- [GUI\\_DispBin](#) on page 306
- [GUI\\_DispHex](#) on page 308

## 6.2.1.4 Displaying hexadecimal values

### 6.2.1.4.1 GUI\_DisgHex()

#### Description

Displays a value in hexadecimal form at the current text position in the current window using the current font.

#### Prototype

```
void GUI_DisgHex(U32 v,  
                U8 Len);
```

#### Parameters

Parameter	Description
<code>v</code>	Value to display, 32-bit.
<code>Len</code>	Number of digits to display.

#### Additional information

As with decimal and binary values, the least significant bit is rightmost.

#### Example

```
//  
// Show value of AD-converter  
//  
GUI_DisgHex(Input, 4);
```

#### Related topics

- *GUI\_DisgDec* on page 293
- *GUI\_DisgBin* on page 306
- *GUI\_DisgHexAt* on page 309

### 6.2.1.4.2 GUI\_DispHexAt()

#### Description

Displays a value in hexadecimal form at a specified position in the current window using the current font.

#### Prototype

```
void GUI_DispHexAt(U32 v,  
                  I16P x,  
                  I16P y,  
                  U8 Len);
```

#### Parameters

Parameter	Description
<a href="#">v</a>	Value to display, 32-bit.
<a href="#">x</a>	X-position to write to in pixels of the client window.
<a href="#">y</a>	Y-position to write to in pixels of the client window.
<a href="#">Len</a>	Number of digits to display.

#### Additional information

As with decimal and binary values, the least significant bit is rightmost.

#### Example

```
//  
// Show value of AD-converter at specified position  
//  
GUI_DispHexAt(Input, 0, 0, 4);
```

#### Related topics

- [GUI\\_DispDec](#) on page 293
- [GUI\\_DispBin](#) on page 306
- [GUI\\_DispHexAt](#) on page 309

### 6.2.1.5 GUI\_GetVersionString()

#### Description

Returns a string containing the current version of emWin.

#### Prototype

```
char *GUI_GetVersionString(void);
```

#### Return value

Returns a pointer to an array of chars containing the current emWin version.

#### Example

```
//  
// Displays the current version at the current cursor position  
//  
GUI_DispString(GUI_GetVersionString());
```

## 6.3 2-D Graphic Library

emWin contains a complete 2-D graphic library which should be sufficient for most applications. The routines supplied with emWin can be used with or without clipping (refer to the chapter *The Window Manager (WM)* on page 960) and are based on fast and efficient algorithms. Currently, only the `GUI_DrawArc()` function requires floating-point calculations.

### 6.3.1 Graphic API

The table below lists the available graphic-related routines in alphabetical order within their respective categories. Detailed descriptions can be found in the sections that follow.

#### Functions

Routine	Description
Drawing related functions	
<code>GUI_AddRect()</code>	This function resizes the given rectangle.
<code>GUI_GetClientRect()</code>	Returns the current available drawing area.
<code>GUI_GetClipRect()</code>	Returns the currently set clip rectangle.
<code>GUI_GetDrawMode()</code>	Returns the current drawing mode.
<code>GUI_GetPenSize()</code>	Returns the current pen size.
<code>GUI_GetPixelIndex()</code>	Returns the color index of a given position.
<code>GUI_SetClipRect()</code>	Sets the rectangle used for clipping.
<code>GUI_SetDrawMode()</code>	Selects the specified drawing mode.
<code>GUI_SetPenSize()</code>	Sets the pen size in pixels.
Basic drawing routines	
<code>GUI_Clear()</code>	Fills the display/the active window with the background color.
<code>GUI_ClearRect()</code>	Fills a rectangular area with the background color.
<code>GUI_CopyRect()</code>	Copies a rectangle area on the display.
<code>GUI_DrawFrame()</code>	Draws a frame of the given size within the specified area.
<code>GUI_DrawFrameEx()</code>	Draws a frame in the current window at the position specified in the rectangle passed to the function.
<code>GUI_DrawGradientH()</code>	Draws a rectangle filled with a horizontal color gradient.
<code>GUI_DrawGradientHEx()</code>	Draws a horizontal color gradient from a <code>GUI_RECT</code> pointer.
<code>GUI_DrawGradientV()</code>	Draws a rectangle filled with a vertical color gradient.
<code>GUI_DrawGradientVEx()</code>	Draws a vertical color gradient from a <code>GUI_RECT</code> pointer.
<code>GUI_DrawGradientRoundedH()</code>	Draws a rectangle with rounded corners filled with a horizontal color gradient.
<code>GUI_DrawGradientRoundedHEx()</code>	Draws a rectangle with rounded corners filled with a horizontal color gradient.

Routine	Description
<code>GUI_DrawGradientRoundedV()</code>	Draws a rectangle with rounded corners filled with a vertical color gradient.
<code>GUI_DrawGradientRoundedVEx()</code>	Draws a vertical color gradient with rounded corners from a <code>GUI_RECT</code> pointer.
<code>GUI_DrawGradientMH()</code>	Draws a rectangle filled with a horizontal multi color gradient.
<code>GUI_DrawGradientMHEX()</code>	Draws a rectangle filled with a horizontal multi color gradient.
<code>GUI_DrawGradientMV()</code>	Draws a rectangle filled with a vertical multi color gradient.
<code>GUI_DrawGradientMVEx()</code>	Draws a vertical multi color gradient from a <code>GUI_RECT</code> pointer.
<code>GUI_DrawPixel()</code>	Draws a single pixel.
<code>GUI_DrawPoint()</code>	Draws a point.
<code>GUI_DrawRect()</code>	Draws a rectangle.
<code>GUI_DrawRectEx()</code>	Draws a rectangle from a <code>GUI_RECT</code> structure.
<code>GUI_DrawRoundedFrame()</code>	Draws a frame with rounded corners.
<code>GUI_DrawRoundedFrameEx()</code>	Draws a frame with rounded corners from a <code>GUI_RECT</code> structure.
<code>GUI_DrawRoundedRect()</code>	Draws a rectangle with rounded corners.
<code>GUI_DrawRoundedRectEx()</code>	Draws a rectangle with rounded corners from a <code>GUI_RECT</code> structure.
<code>GUI_FillRect()</code>	Draws a filled rectangle.
<code>GUI_FillRectEx()</code>	Draws a filled rectangle from a <code>GUI_RECT</code> structure.
<code>GUI_FillRoundedRect()</code>	Draws a filled rectangle with rounded corners.
<code>GUI_FillRoundedRectEx()</code>	Draws a filled rectangle with rounded corners from a <code>GUI_RECT</code> structure.
<code>GUI_InvertRect()</code>	Invert a rectangular area.
<b>Alpha blending</b>	
<code>GUI_EnableAlpha()</code>	Enables/disables automatic alpha blending.
<code>GUI_PreserveTrans()</code>	Makes sure that alpha channel remains after drawing operations.
<code>GUI_RestoreUserAlpha()</code>	Restores the previous state of user alpha blending
<code>GUI_SetAlpha()</code>	Sets the current alpha blending value. (Obsolete)
<code>GUI_SetUserAlpha()</code>	Sets an additional value which is used to calculate the actual alpha blending value to be used.
<b>Drawing bitmaps</b>	
<code>GUI_DrawBitmap()</code>	Draws a bitmap.
<code>GUI_DrawBitmapEx()</code>	Draws a scaled bitmap.
<code>GUI_DrawBitmapMag()</code>	Draws a magnified bitmap.



Routine	Description
<code>GUI_SetAlphaMask8888()</code>	Can be used for setting an additional AND and OR mask to be used for drawing the pixels of 32bpp bitmaps.
<b>Drawing streamed bitmaps</b>	
<code>GUI_CreateBitmapFromStream()</code>	Creates a bitmap from a given stream of any type.
<code>GUI_CreateBitmapFromStreamIDX()</code>	Creates a bitmap from an index based bitmap stream.
<code>GUI_CreateBitmapFromStreamRLE1()</code>	Creates a bitmap from an RLE1 bitmap stream.
<code>GUI_CreateBitmapFromStreamRLE4()</code>	Creates a bitmap from an RLE4 bitmap stream.
<code>GUI_CreateBitmapFromStreamRLE8()</code>	Creates a bitmap from an RLE8 bitmap stream.
<code>GUI_CreateBitmapFromStream444_12()</code>	Creates a bitmap from a 12bpp (444_12) bitmap stream.
<code>GUI_CreateBitmapFromStream444_12_1()</code>	Creates a bitmap from a 12bpp (444_12_1) bitmap stream.
<code>GUI_CreateBitmapFromStreamM444_12()</code>	Creates a bitmap from a 12bpp (M444_12) bitmap stream.
<code>GUI_CreateBitmapFromStreamM444_12_1()</code>	Creates a bitmap from a 12bpp (M444_12_1) bitmap stream.
<code>GUI_CreateBitmapFromStream444_16()</code>	Creates a bitmap from a 12bpp (444_16) bitmap stream.
<code>GUI_CreateBitmapFromStreamM444_16()</code>	Creates a bitmap from a 12bpp (444_16_1) bitmap stream.
<code>GUI_CreateBitmapFromStreamA555()</code>	Creates a bitmap with an alpha channel from a 16bpp (A555) bitmap stream.
<code>GUI_CreateBitmapFromStreamAM555()</code>	Creates a bitmap with an alpha channel from a 16bpp (AM555) bitmap stream.
<code>GUI_CreateBitmapFromStreamA565()</code>	Creates a bitmap with an alpha channel from a 16bpp (A565) bitmap stream.
<code>GUI_CreateBitmapFromStreamAM565()</code>	Creates a bitmap with an alpha channel from a 16bpp (AM565) bitmap stream.
<code>GUI_CreateBitmapFromStream565()</code>	Creates a bitmap from a 16bpp (565) bitmap stream.
<code>GUI_CreateBitmapFromStreamM565()</code>	Creates a bitmap from a 16bpp (M565) bitmap stream with red and blue swapped.
<code>GUI_CreateBitmapFromStream555()</code>	Creates a bitmap from a 16bpp (555) bitmap stream.
<code>GUI_CreateBitmapFromStreamM555()</code>	Creates a bitmap from a 16bpp (M555) bitmap stream with red and blue swapped.
<code>GUI_CreateBitmapFromStreamRLE16()</code>	Creates a bitmap from an RLE16 (565) bitmap stream.
<code>GUI_CreateBitmapFromStreamRLEM16()</code>	Creates a bitmap from an RLEM16 (M565) bitmap stream with red and blue swapped.
<code>GUI_CreateBitmapFromStream24()</code>	Creates a bitmap from a 24 bit bitmap stream.

<b>Routine</b>	<b>Description</b>
<code>GUI_CreateBitmapFromStreamAlpha()</code>	Creates a bitmap from a 32 bit bitmap stream.
<code>GUI_CreateBitmapFromStreamRLEAlpha()</code>	Creates a bitmap from an RLE compressed 8 bit alpha bitmap stream.
<code>GUI_CreateBitmapFromStreamRLE32()</code>	Creates a bitmap from an RLE32 bitmap stream.
<code>GUI_DrawStreamedBitmap()</code>	Draws a bitmap from an indexed based bitmap stream (1 - 8bpp).
<code>GUI_DrawStreamedBitmapAuto()</code>	Draws a bitmap from a bitmap stream of any supported format.
<code>GUI_DrawStreamedBitmapEx()</code>	Draws a bitmap from an indexed based bitmap stream (1 - 8bpp) without loading the complete image.
<code>GUI_DrawStreamedBitmapExAuto()</code>	Draws a bitmap from a bitmap stream of any supported format without loading the complete image.
<code>GUI_DrawStreamedBitmapA555Ex()</code>	Draws a bitmap from a 16bpp (A555) bitmap stream with alpha channel without loading the complete image.
<code>GUI_DrawStreamedBitmapAM555Ex()</code>	Draws a bitmap from a 16bpp (AM555) bitmap stream with alpha channel without loading the complete image.
<code>GUI_DrawStreamedBitmapA565Ex()</code>	Draws a bitmap from a 16bpp (AM565) bitmap stream with alpha channel without loading the complete image.
<code>GUI_DrawStreamedBitmapAM565Ex()</code>	Draws a bitmap from a 16bpp (AM565) bitmap stream with alpha channel without loading the complete image.
<code>GUI_DrawStreamedBitmap555Ex()</code>	Draws a bitmap from a 16bpp (555) bitmap stream without loading the complete image.
<code>GUI_DrawStreamedBitmapM555Ex()</code>	Draws a bitmap from a 16bpp (M555) bitmap stream without loading the complete image.
<code>GUI_DrawStreamedBitmap565Ex()</code>	Draws a bitmap from a 16bpp (565) bitmap stream without loading the complete image.
<code>GUI_DrawStreamedBitmapM565Ex()</code>	Draws a bitmap from a 16bpp (M565) bitmap stream without loading the complete image.
<code>GUI_DrawStreamedBitmap24Ex()</code>	Draws a bitmap from a 24bpp bitmap stream without loading the complete image.
<code>GUI_GetStreamedBitmapInfo()</code>	Returns information about the given stream.
<code>GUI_GetStreamedBitmapInfoEx()</code>	Returns information about the given stream which can be located on any kind of media.
<code>GUI_SetStreamedBitmapHook()</code>	Sets a hook function for <code>GUI_DrawStreamedBitmapEx()</code> .
<b>Drawing lines</b>	
<code>GUI_DrawHLine()</code>	Draws a horizontal line.

Routine	Description
<code>GUI_DrawLine()</code>	Draws a line from a specified starting point to a specified endpoint in the current window (absolute coordinates).
<code>GUI_DrawLineRel()</code>	Draws a line from the current (x, y) position to an endpoint specified by X-distance and Y-distance in the current window (relative coordinates).
<code>GUI_DrawLineTo()</code>	Draws a line from the current position to a specified endpoint.
<code>GUI_DrawPolyLine()</code>	Draws a polyline.
<code>GUI_DrawVLine()</code>	Draws a vertical line.
<code>GUI_GetLineStyle()</code>	Returns the current line style used by the function <code>GUI_DrawLine</code> .
<code>GUI_MoveRel()</code>	Moves the current line pointer relative to its current position.
<code>GUI_MoveTo()</code>	Moves the current line pointer to the given position.
<code>GUI_SetLineStyle()</code>	Sets the current line style used by the function <code>GUI_DrawLine()</code> .
<b>Drawing polygons</b>	
<code>GUI_DrawPolygon()</code>	Draws the outline of a polygon.
<code>GUI_EnlargePolygon()</code>	Enlarges a polygon.
<code>GUI_FillPolygon()</code>	Draws a filled polygon.
<code>GUI_MagnifyPolygon()</code>	Magnifies a polygon by a specified factor.
<code>GUI_RotatePolygon()</code>	Rotates a polygon by a specified angle.
<b>Drawing circles</b>	
<code>GUI_DrawCircle()</code>	Draws the outline of a circle.
<code>GUI_FillCircle()</code>	Draws a filled circle.
<b>Drawing ellipses</b>	
<code>GUI_DrawEllipse()</code>	Draws the outline of an ellipse.
<code>GUI_DrawEllipseXL()</code>	Draws the outline of a large ellipse.
<code>GUI_FillEllipse()</code>	Draws a filled ellipse.
<b>Drawing arcs</b>	
<code>GUI_DrawArc()</code>	Draws an arc.
<code>GUI_DrawArcHR()</code>	Draws an arc of specified dimensions at a specified position in the current window.
<code>GUI_DrawArcHREx()</code>	Draws an arc with optionally rounded ends.
<b>Drawing a graph</b>	
<code>GUI_DrawGraph()</code>	Draws a graph.
<b>Drawing barcodes</b>	
<code>GUI_BARCODE_Draw()</code>	Draws a barcode.
<code>GUI_BARCODE_GetXSize()</code>	Returns the X-size of a given barcode without drawing it.
<b>Drawing QR codes</b>	

Routine	Description
<code>GUI_QR_Create()</code>	Creates a QR-code bitmap.
<code>GUI_QR_CreateFramed()</code>	Creates a QR-code bitmap with a white frame around it.
<code>GUI_QR_Delete()</code>	Deletes a QR-code bitmap.
<code>GUI_QR_Draw()</code>	Draws a QR-code bitmap.
<code>GUI_QR_GetInfo()</code>	Fills an information structure.
<b>Drawing a pie chart</b>	
<code>GUI_DrawPie()</code>	Draws a circle sector.
<code>GUI_DrawPieHR()</code>	Draws a circle sector.
<b>Drawing a spline</b>	
<code>GUI_SPLINE_Create()</code>	Creates a spline.
<code>GUI_SPLINE_Delete()</code>	Deletes a spline.
<code>GUI_SPLINE_Draw()</code>	Draws a spline.
<code>GUI_SPLINE_DrawAA()</code>	Draw an anti aliased spline.
<code>GUI_SPLINE_GetY()</code>	Return the Y-value of a point.
<code>GUI_SPLINE_GetXSize()</code>	Returns the X-size of a spline.
<b>YUV device</b>	
<code>GUI_YUV_Create()</code>	Creates a YUV device in the current layer.
<code>GUI_YUV_CreateEx()</code>	Creates a YUV device in the given layer with the given period.
<code>GUI_YUV_Delete()</code>	Deletes the YUV device of the current layer.
<code>GUI_YUV_DeleteEx()</code>	Deletes the YUV device of the given layer.
<code>GUI_YUV_GetpData()</code>	Returns a pointer to the YUV plane of the current layer and the size of the plane in bytes.
<code>GUI_YUV_GetpDataEx()</code>	Returns a pointer to the YUV plane of the given layer and the size of the plane in bytes.
<code>GUI_YUV_InvalidateArea()</code>	Invalidates the given area of the current layer.
<code>GUI_YUV_SetPeriod()</code>	Sets the recalculation period of the YUV device in the current layer.
<code>GUI_YUV_SetPeriodEx()</code>	Sets the period to be used for (re)calculation.

## Data structures

Structure	Description
<code>GUI_ALPHA_STATE</code>	Used for storing the alpha value with <code>GUI_SetUserAlpha()</code> .
<code>GUI_BITMAPSTREAM_INFO</code>	Information about a streamed bitmap.
<code>GUI_BITMAPSTREAM_PARAM</code>	Contains a command to be used by a set hook function for <code>GUI_DrawStreamedBitmapEx()</code> .
<code>GUI_GRADIENT_INFO</code>	Information used for drawing multi-color gradients.
<code>GUI_POINT</code>	Point on the screen.

Structure	Description
<a href="#">GUI_QR_INFO</a>	Information about a QR code.
<a href="#">GUI_RECT</a>	Rectangle on the screen.

## Defines

Group of defines	Description
<a href="#">Axis values</a>	Defines to distinguish between the X and Y axis.
<a href="#">Barcode types</a>	Type of barcode to be drawn.
<a href="#">Drawing modes</a>	Mode to be used for drawing operations.
<a href="#">ECC levels for QR codes</a>	Error correction level to be used for a QR code.
<a href="#">Line styles</a>	Style how a line is drawn.

## Prototypes

Prototype	Description
<a href="#">GUI_DTA_GET_DATA_FUNC</a>	GetData function used for streamed bitmaps (DTA), for more details see <a href="#">GUI_GET_DATA_FUNC_II</a> .

## 6.3.1.1 Drawing related functions

### 6.3.1.1.1 GUI\_AddRect()

#### Description

This function resizes the given rectangle.

#### Prototype

```
void GUI_AddRect(      GUI_RECT * pDest,  
                    const GUI_RECT * pRect,  
                    int          Dist);
```

#### Parameters

Parameter	Description
<code>pDest</code>	Pointer to a rectangle where the modified rectangle gets stored in.
<code>pRect</code>	Pointer to the original rectangle.
<code>Dist</code>	Value to be added to the rect. If negative it gets subtracted.

### 6.3.1.1.2 GUI\_GetClientRect()

#### Description

The current client rectangle depends on using the Window Manager or not. If using the Window Manager the function uses `WM_GetClientRect` to retrieve the client rectangle. If not using the Window Manager the client rectangle corresponds to the complete LCD display.

#### Prototype

```
void GUI_GetClientRect(GUI_RECT * pRect);
```

#### Parameters

Parameter	Description
<code>pRect</code>	Pointer to the <code>GUI_RECT</code> -structure which is filled with the coordinates of the client rectangle.

### 6.3.1.1.3 GUI\_GetClipRect()

#### Description

Returns the currently set clip rectangle.

#### Prototype

```
GUI_RECT *GUI_GetClipRect(void);
```

#### Return value

Pointer to the currently set clip rectangle.



#### 6.3.1.1.4 GUI\_GetDrawMode()

##### Description

Returns the current drawing mode.

##### Prototype

```
GUI_DRAWMODE GUI_GetDrawMode(void);
```

##### Return value

The currently selected drawing mode, see at *Drawing modes* on page 442.

### 6.3.1.1.5 GUI\_GetPenSize()

#### Description

Returns the current pen size.

#### Prototype

```
U16 GUI_GetPenSize(void);
```

#### Return value

The current pen size.

### 6.3.1.1.6 GUI\_GetPixelIndex()

#### Description

Returns the color index of a given position.

#### Prototype

```
unsigned GUI_GetPixelIndex(int x,  
                           int y);
```

#### Parameters

Parameter	Description
<code>x</code>	Absolute <code>x</code> -position of the pixel
<code>y</code>	Absolute <code>y</code> -position of the pixel

#### Return value

The color index of the given position.

### 6.3.1.1.7 GUI\_SetClipRect()

#### Description

Sets the clipping rectangle used for limiting the output.

#### Prototype

```
GUI_RECT *GUI_SetClipRect(const GUI_RECT * pRect);
```

#### Parameters

Parameter	Description
<code>pRect</code>	Pointer to the rectangle which should be used for clipping. A NULL pointer should be used to restore the default value.

#### Return value

Pointer to the old clipping rectangle.

#### Additional information

The clipping area is limited to the configured (virtual) display size per default. Under some circumstances it can be useful to use a smaller clipping rectangle, which can be set using this function. The rectangle referred to should remain unchanged until the function is called again with a NULL pointer.

#### Example

The following example shows how to use the function:

```
GUI_RECT Rect = {10, 10, 100, 100};
GUI_SetClipRect(&Rect);
.
. // Draw something...
.
GUI_SetClipRect(NULL);
```

### 6.3.1.1.8 GUI\_SetDrawMode()

#### Description

Selects the specified drawing mode.

#### Prototype

```
GUI_DRAWMODE GUI_SetDrawMode(GUI_DRAWMODE dm);
```

#### Parameters

Parameter	Description
<code>dm</code>	Drawing mode to set. Full list of permitted values can be found under <i>Drawing modes</i> on page 442.

#### Return value

The previously set drawing mode.

#### Additional information

If using colors, an inverted pixel is calculated as follows:

#### Example

```
//  
// Showing two circles, the second one XOR-combined with the first:  
//  
GUI_Clear();  
GUI_SetDrawMode(GUI_DRAWMODE_NORMAL);  
GUI_FillCircle(120, 64, 40);  
GUI_SetDrawMode(GUI_DRAWMODE_XOR);  
GUI_FillCircle(140, 84, 40);
```

#### Screenshot of above example



### 6.3.1.1.9 GUI\_SetPenSize()

#### Description

Sets the pen size to be used for further drawing operations.

#### Prototype

```
U16 GUI_SetPenSize(U16 PenSize);
```

#### Parameters

Parameter	Description
PenSize	Pen size in pixels to be used.

#### Return value

Previous pen size.

#### Additional information

The pen size should be  $\geq 1$ . It is not possible to combine line styles with a pen size  $> 1$ .

The following vector drawing operations are affected by the pen size:

- GUI\_DrawPoint()
- GUI\_DrawLine()
- GUI\_DrawLineRel()
- GUI\_DrawLineTo()
- GUI\_DrawPolyLine()
- GUI\_DrawPolygon()
- GUI\_DrawEllipse()
- GUI\_DrawArc()
- GUI\_DrawRect()
- GUI\_DrawRectEx()

## 6.3.1.2 Basic drawing routines

The basic drawing routines allow drawing of individual points, horizontal and vertical lines and shapes at any position on the display. Any available drawing mode can be used. Since these routines are called frequently in most applications, they are optimized for speed as much as possible. For example, the horizontal and vertical line functions do not require the use of single-dot routines.

### 6.3.1.2.1 GUI\_Clear()

#### Description

Clears the current window.

#### Prototype

```
void GUI_Clear(void);
```

#### Additional information

If no window has been defined, the current window is the entire display. In this case, the entire display is cleared.

#### Example

```
GUI_DispStringAt("Hello world", 0, 0); // Display text.  
GUI_Delay(1000); // Wait 1 second.  
GUI_Clear(); // Clear screen.
```

### 6.3.1.2.2 GUI\_ClearRect()

#### Description

Clears a rectangular area at a specified position in the current window by filling it with the background color.

#### Prototype

```
void GUI_ClearRect(int x0,  
                  int y0,  
                  int x1,  
                  int y1);
```

#### Parameters

Parameter	Description
<code>x0</code>	Upper left X-position.
<code>y0</code>	Upper left Y-position.
<code>x1</code>	Lower right X-position.
<code>y1</code>	Lower right Y-position.

#### Related topics

- *GUI\_InvertRect* on page 354
- *GUI\_FillRect* on page 350



### 6.3.1.2.3 GUI\_CopyRect()

#### Description

Copies the content of the given rectangular area to the specified position.

#### Prototype

```
void GUI_CopyRect(int x0,  
                 int y0,  
                 int x1,  
                 int y1,  
                 int xSize,  
                 int ySize);
```

#### Parameters

Parameter	Description
x0	Upper left X-position of the source rectangle.
y0	Upper left Y-position of the source rectangle.
x1	Upper left X-position of the destination rectangle.
y1	Upper left Y-position of the destination rectangle.
xSize	X-size of the rectangle.
ySize	Y-size of the rectangle.

#### Additional information

The source and destination rectangle may overlap each other.

### 6.3.1.2.4 GUI\_DrawFrame()

#### Description

Draws a frame of the given size within the specified area.

The difference between `GUI_DrawRect()` and `GUI_DrawFrame()` is that if the rectangle to be drawn is thicker than 1 px

- `GUI_DrawRect()` will draw lines inside and outside of the rectangle to keep the drawn rectangle centered around the given position while
- `GUI_DrawFrame()` will draw lines only within the rectangle.

#### Prototype

```
void GUI_DrawFrame(int x0,  
                  int y0,  
                  int x1,  
                  int y1,  
                  int Size);
```

#### Parameters

Parameter	Description
<code>x0</code>	Upper left X-position.
<code>y0</code>	Upper left Y-position.
<code>x1</code>	Lower right X-position.
<code>y1</code>	Lower right Y-position.
<code>Size</code>	Width of the frame.

### 6.3.1.2.5 GUI\_DrawFrameEx()

#### Description

Draws a frame in the current window at the position specified in the rectangle passed to the function.

To learn about the difference between `GUI_DrawRect()` and `GUI_DrawFrame()`, see the description of `GUI_DrawFrame()`.

#### Prototype

```
void GUI_DrawFrameEx(const GUI_RECT * pRect,  
                    int           Size);
```

#### Parameters

Parameter	Description
<code>pRect</code>	Pointer to a <code>GUI_RECT</code> -structure containing the coordinates of the frame.
<code>Size</code>	Width of the frame.

### 6.3.1.2.6 GUI\_DrawGradientH()

#### Description

Draws a rectangle filled with a horizontal color gradient.

#### Prototype

```
void GUI_DrawGradientH(int    x0,  
                      int    y0,  
                      int    x1,  
                      int    y1,  
                      GUI_COLOR Color0,  
                      GUI_COLOR Color1);
```

#### Parameters

Parameter	Description
<code>x0</code>	Upper left X-position.
<code>y0</code>	Upper left Y-position.
<code>x1</code>	Lower right X-position.
<code>y1</code>	Lower right Y-position.
<code>Color0</code>	Color to be drawn on the leftmost side of the rectangle.
<code>Color1</code>	Color to be drawn on the rightmost side of the rectangle.

#### Example

```
GUI_DrawGradientH(0, 0, 99, 99, 0x0000FF, 0x00FFFF);
```

#### Screenshot of above example



### 6.3.1.2.7 GUI\_DrawGradientHEX()

#### Description

Draws a horizontal color gradient from a GUI\_RECT pointer.

#### Prototype

```
void GUI_DrawGradientHEX(const GUI_RECT * pRect,  
                        GUI_COLOR  Color0,  
                        GUI_COLOR  Color1);
```

#### Parameters

Parameter	Description
<code>pRect</code>	Pointer to a GUI_RECT structure.
<code>Color0</code>	Color to be drawn on the leftmost side of the rectangle.
<code>Color1</code>	Color to be drawn on the rightmost side of the rectangle.

### 6.3.1.2.8 GUI\_DrawGradientV()

#### Description

Draws a rectangle filled with a vertical color gradient.

#### Prototype

```
void GUI_DrawGradientV(int    x0,  
                      int    y0,  
                      int    x1,  
                      int    y1,  
                      GUI_COLOR Color0,  
                      GUI_COLOR Color1);
```

#### Parameters

Parameter	Description
<code>x0</code>	Upper left X-position.
<code>y0</code>	Upper left Y-position.
<code>x1</code>	Lower right X-position.
<code>y1</code>	Lower right Y-position.
<code>Color0</code>	Color to be drawn on the topmost side of the rectangle.
<code>Color1</code>	Color to be drawn on the bottommost side of the rectangle.

#### Example

```
GUI_DrawGradientV(0, 0, 99, 99, 0x0000FF, 0x00FFFF);
```

#### Screenshot of above example



### 6.3.1.2.9 GUI\_DrawGradientVEx()

#### Description

Draws a vertical color gradient from a GUI\_RECT pointer.

#### Prototype

```
void GUI_DrawGradientVEx(const GUI_RECT * pRect,  
                        GUI_COLOR  Color0,  
                        GUI_COLOR  Color1);
```

#### Parameters

Parameter	Description
<code>pRect</code>	Pointer to a GUI_RECT structure.
<code>Color0</code>	Color to be drawn on the topmost side of the rectangle.
<code>Color1</code>	Color to be drawn on the bottommost side of the rectangle.

### 6.3.1.2.10 GUI\_DrawGradientRoundedH()

#### Description

Draws a rectangle with rounded corners filled with a horizontal color gradient.

#### Prototype

```
void GUI_DrawGradientRoundedH(int    x0,
                              int    y0,
                              int    x1,
                              int    y1,
                              int    rd,
                              GUI_COLOR Color0,
                              GUI_COLOR Color1);
```

#### Parameters

Parameter	Description
<code>x0</code>	Upper left X-position.
<code>y0</code>	Upper left Y-position.
<code>x1</code>	Lower right X-position.
<code>y1</code>	Lower right Y-position.
<code>rd</code>	Radius to be used for the rounded corners.
<code>Color0</code>	Color to be drawn on the leftmost side of the rectangle.
<code>Color1</code>	Color to be drawn on the rightmost side of the rectangle.

#### Example

```
GUI_DrawGradientRoundedH(0, 0, 99, 99, 25, 0x0000FF, 0x00FFFF);
```

#### Screenshot of above example





### 6.3.1.2.11 GUI\_DrawGradientRoundedHEx()

#### Description

Draws a rectangle with rounded corners filled with a horizontal color gradient.

#### Prototype

```
void GUI_DrawGradientRoundedHEx(const GUI_RECT * pRect,
                                int          rd,
                                GUI_COLOR   Color0,
                                GUI_COLOR   Color1);
```

#### Parameters

Parameter	Description
<code>pRect</code>	Pointer to a GUI_RECT structure.
<code>rd</code>	Radius to be used for the rounded corners.
<code>Color0</code>	Color to be drawn on the leftmost side of the rectangle.
<code>Color1</code>	Color to be drawn on the rightmost side of the rectangle.

### 6.3.1.2.12 GUI\_DrawGradientRoundedV()

#### Description

Draws a rectangle with rounded corners filled with a vertical color gradient.

#### Prototype

```
void GUI_DrawGradientRoundedV(int    x0,  
                             int    y0,  
                             int    x1,  
                             int    y1,  
                             int    rd,  
                             GUI_COLOR Color0,  
                             GUI_COLOR Color1);
```

#### Parameters

Parameter	Description
<code>x0</code>	Upper left X-position.
<code>y0</code>	Upper left Y-position.
<code>x1</code>	Lower right X-position.
<code>y1</code>	Lower right Y-position.
<code>rd</code>	Radius to be used for the rounded corners.
<code>Color0</code>	Color to be drawn on the leftmost side of the rectangle.
<code>Color1</code>	Color to be drawn on the rightmost side of the rectangle.

#### Example

```
GUI_DrawGradientRoundedV(0, 0, 99, 99, 25, 0x0000FF, 0x00FFFF);
```

#### Screenshot of above example



### 6.3.1.2.13 GUI\_DrawGradientRoundedVEx()

#### Description

Draws a vertical color gradient with rounded corners from a GUI\_RECT pointer.

#### Prototype

```
void GUI_DrawGradientRoundedVEx(const GUI_RECT * pRect,  
                                int rd,  
                                GUI_COLOR Color0,  
                                GUI_COLOR Color1);
```

#### Parameters

Parameter	Description
<code>pRect</code>	Pointer to a GUI_RECT structure.
<code>rd</code>	Radius to be used for the rounded corners.
<code>Color0</code>	Color to be drawn on the leftmost side of the rectangle.
<code>Color1</code>	Color to be drawn on the rightmost side of the rectangle.

### 6.3.1.2.14 GUI\_DrawGradientMH()

### 6.3.1.2.15 GUI\_DrawGradientMV()

#### Description

These functions draw a multi color gradient either horizontal or vertical.

#### Prototype

```
void GUI_DrawGradientMH(int          x0,
                       int          y0,
                       int          y1,
                       GUI_GRADIENT_INFO * pGradientInfo,
                       int          NumColors);

void GUI_DrawGradientMV(int          x0,
                       int          y0,
                       int          x1,
                       GUI_GRADIENT_INFO * pGradientInfo,
                       int          NumColors);
```

#### Parameters

Parameter	Description
x0	Upper left X-position.
y0	Upper left Y-position.
x1	Lower right X-position.
pGradientInfo	Pointer to a GUI_GRADIENT_INFO structure.
NumColors	Number of colors in pGradientInfo.

#### Additional information

The member Pos of the GUI\_GRADIENT\_INFO structure is used to define the start and end position of the colors. It defines also the size of the gradient (commonly known as y1).

#### Example

```
#include "GUI.h"
/*****
 *
 *      MainTask
 */
void MainTask(void) {
    GUI_GRADIENT_INFO aInfo[] = {
        {0,  GUI_RED},
        {60, GUI_GREEN},
        {120, GUI_BLUE}, // Resulting in a gradient with a size of 120 Pixel
    };
    GUI_Init();
    GUI_DrawGradientMH(0, 0, 120, &aInfo[0], GUI_COUNTOF(aInfo));
    while (1) {
        GUI_Delay(100);
    }
}
```

**6.3.1.2.16 GUI\_DrawGradientMHEx()****6.3.1.2.17 GUI\_DrawGradientMVEx()****Description**

These functions draw a multi color gradient either horizontal or vertical from a `GUI_RECT` pointer. See the functions `GUI_DrawGradientMH()` and `GUI_DrawGradientMV()` for more information.

**Prototype**

```
void GUI_DrawGradientMHEx(GUI_RECT      * pRect,
                          GUI_GRADIENT_INFO * pGradientInfo,
                          int             NumColors);

void GUI_DrawGradientMVEx(GUI_RECT      * pRect,
                          GUI_GRADIENT_INFO * pGradientInfo,
                          int             NumColors);
```

**Parameters**

Parameter	Description
<code>pRect</code>	Pointer to a <code>GUI_RECT</code> structure.
<code>pGradientInfo</code>	Pointer to a <code>GUI_GRADIENT_INFO</code> structure.
<code>NumColors</code>	Number of colors in <code>pGradientInfo</code> .

**Additional information**

The member `Pos` of the `GUI_GRADIENT_INFO` structure is used to define the start and end position of the colors. It defines also the size of the gradient.

### 6.3.1.2.18 GUI\_DrawPixel()

#### Description

Draws a pixel at a specified position in the current window.

#### Prototype

```
void GUI_DrawPixel(int x,  
                  int y);
```

#### Parameters

Parameter	Description
<code>x</code>	X-position of pixel.
<code>y</code>	Y-position of pixel.

#### Related topics

- [GUI\\_DrawPoint](#) on page 343

### 6.3.1.2.19 GUI\_DrawPoint()

#### Description

Draws a point with the current pen size at a specified position in the current window.

#### Prototype

```
void GUI_DrawPoint(int x,  
                  int y);
```

#### Parameters

Parameter	Description
<code>x</code>	X-position of point.
<code>y</code>	Y-position of point.

#### Related topics

- [GUI\\_DrawPixel](#) on page 342

### 6.3.1.2.20 GUI\_DrawRect()

#### Description

Draws a rectangle at a specified position in the current window.

#### Prototype

```
void GUI_DrawRect (int x0,  
                  int y0,  
                  int x1,  
                  int y1);
```

#### Parameters

Parameter	Description
x0	Upper left X-position.
y0	Upper left Y-position.
x1	Lower right X-position.
y1	Lower right Y-position.



### 6.3.1.2.21 GUI\_DrawRectEx()

#### Description

Draws a rectangle in the current window at the position specified in the rectangle passed to the function.

#### Prototype

```
void GUI_DrawRectEx(const GUI_RECT * pRect);
```

#### Parameters

Parameter	Description
<code>pRect</code>	Pointer to a GUI_RECT-structure containing the coordinates of the rectangle

### 6.3.1.2.22 GUI\_DrawRoundedFrame()

#### Description

Draws a frame at a specified position in the current window with rounded corners and a specified width.

#### Prototype

```
void GUI_DrawRoundedFrame(int x0,  
                           int y0,  
                           int x1,  
                           int y1,  
                           int r,  
                           int w);
```

#### Parameters

Parameter	Description
x0	Upper left X-position.
y0	Upper left Y-position.
x1	Lower right X-position.
y1	Lower right Y-position.
r	Radius to be used for the rounded corners.
w	Width in which the frame is drawn.

### 6.3.1.2.23 GUI\_DrawRoundedFrameEx()

#### Description

Draws a frame at a specified position in the current window with rounded corners and a specified width.

#### Prototype

```
void GUI_DrawRoundedFrameEx(const GUI_RECT * pRect,  
                             int          r,  
                             int          w);
```

#### Parameters

Parameter	Description
<code>pRect</code>	Pointer to a GUI_RECT structure.
<code>r</code>	Radius to be used for the rounded corners.
<code>w</code>	Width in which the frame is drawn.

### 6.3.1.2.24 GUI\_DrawRoundedRect()

#### Description

Draws a rectangle at a specified position in the current window with rounded corners.

#### Prototype

```
void GUI_DrawRoundedRect(int x0,  
                        int y0,  
                        int x1,  
                        int y1,  
                        int r);
```

#### Parameters

Parameter	Description
x0	Upper left X-position.
y0	Upper left Y-position.
x1	Lower right X-position.
y1	Lower right Y-position.
r	Radius to be used for the rounded corners.

### 6.3.1.2.25 GUI\_DrawRoundedRectEx()

#### Description

Draws a rectangle at a specified position in the current window with rounded corners.

#### Prototype

```
void GUI_DrawRoundedRectEx(const GUI_RECT * pRect,  
                           int           r);
```

#### Parameters

Parameter	Description
<code>pRect</code>	Pointer to a GUI_RECT structure.
<code>r</code>	Radius to be used for the rounded corners.

### 6.3.1.2.26 GUI\_FillRect()

#### Description

Draws a filled rectangular area at a specified position in the current window.

#### Prototype

```
void GUI_FillRect(int x0,  
                 int y0,  
                 int x1,  
                 int y1);
```

#### Parameters

Parameter	Description
x0	Upper left X-position.
y0	Upper left Y-position.
x1	Lower right X-position.
y1	Lower right Y-position.

#### Additional information

Uses the current drawing mode, which normally means all pixels inside the rectangle are set.

#### Related topics

- *GUI\_InvertRect* on page 354
- *GUI\_ClearRect* on page 328

### 6.3.1.2.27 GUI\_FillRectEx()

#### Description

Draws a filled rectangular area in the current window at the position specified in the rectangle passed to the function.

#### Prototype

```
void GUI_FillRectEx(const GUI_RECT * pRect);
```

#### Parameters

Parameter	Description
<code>pRect</code>	Pointer to a GUI_RECT-structure containing the coordinates of the rectangle.

### 6.3.1.2.28 GUI\_FillRoundedRect()

#### Description

Draws a filled rectangle at a specified position in the current window with rounded corners.

#### Prototype

```
void GUI_FillRoundedRect(int x0,  
                        int y0,  
                        int x1,  
                        int y1,  
                        int r);
```

#### Parameters

Parameter	Description
x0	Upper left X-position.
y0	Upper left Y-position.
x1	Lower right X-position.
y1	Lower right Y-position.
r	Radius to be used for the rounded corners.



### 6.3.1.2.29 GUI\_FillRoundedRectEx()

#### Description

Draws a filled rectangle at a specified position in the current window with rounded corners.

#### Prototype

```
void GUI_FillRoundedRectEx(const GUI_RECT * pRect,  
                           int           r);
```

#### Parameters

Parameter	Description
<code>pRect</code>	Pointer to a <code>GUI_RECT</code> structure containing the coordinates of the rectangle.
<code>r</code>	Radius to be used for the rounded corners.

### 6.3.1.2.30 GUI\_InvertRect()

#### Description

Draws an inverted rectangular area at a specified position in the current window.

#### Prototype

```
void GUI_InvertRect(int x0,  
                   int y0,  
                   int x1,  
                   int y1);
```

#### Parameters

Parameter	Description
<a href="#">x0</a>	Upper left X-position.
<a href="#">y0</a>	Upper left Y-position.
<a href="#">x1</a>	Lower right X-position.
<a href="#">y1</a>	Lower right Y-position.

#### Related topics

- [GUI\\_FillRect](#) on page 350
- [GUI\\_ClearRect](#) on page 328

### 6.3.1.3 Alpha blending

Alpha blending is a method of combining a foreground image with the background to create the appearance of semi transparency. An alpha value determines how much of a pixel should be visible and how much of the background should show through.

#### Color information

emWin internally works with 32 bits of color information. It is important to know that emWin is able to use 2 different color formats. For details please refer to *Logical colors* on page 606. That chapter explains the differences between both logical color modes. Important here is to know that when using the default logical color format (ABGR) an alpha value of 0 means opaque and a value of 255 means completely transparent. In case of using ARGB the meaning is vice versa: 0 means completely transparent and 255 means opaque. The documentation assumes using the default format (ABGR).

#### How it works

The alpha blending is done completely automatically once it is enabled by using the function `GUI_EnableAlpha()`. This makes emWin regard the upper 8 bits of the color information as alpha value. Enabling alpha blending is required only for functions which use the background or foreground color. Bitmaps which already contain alpha values (32bpp) are automatically displayed properly, so enabling alpha blending is not required in this case.

#### Example

The following small example shows how it works:

```
GUI_EnableAlpha(1);
GUI_SetBkColor(GUI_WHITE);
GUI_Clear();
GUI_SetColor(GUI_BLACK);
GUI_DispStringHCenterAt("Alphablending", 45, 41);
GUI_SetColor(GUI_MAKE_COLOR((0x40uL << 24) | 0x0000FF));
GUI_FillRect(0, 0, 49, 49);
GUI_SetColor(GUI_MAKE_COLOR((0x80uL << 24) | 0x00FF00));
GUI_FillRect(20, 20, 69, 69);
GUI_SetColor(GUI_MAKE_COLOR((0xC0uL << 24) | 0xFF0000));
GUI_FillRect(40, 40, 89, 89);
GUI_EnableAlpha(0);
```



#### Older versions

In older versions it was required to use the function `GUI_SetAlpha()` for blending the foreground with the current background color information. This also works but is no longer required.

### 6.3.1.3.1 GUI\_EnableAlpha()

#### Description

Enables or disables automatic alpha blending.

#### Prototype

```
unsigned GUI_EnableAlpha(unsigned OnOff);
```

#### Parameters

Parameter	Description
OnOff	1 enables automatic alpha blending, 0 disables it.

#### Return value

Old state.

#### Additional information

After enabling automatic alpha blending the color information of each object automatically determines its transparency. It is recommended to disable the function after it has been used to avoid unwanted behavior.

#### Note

If alpha blending does not get disabled after using it, it might have a heavy impact on the overall performance.

### 6.3.1.3.2 GUI\_PreserveTrans()

#### Description

Makes sure that alpha channel remains after drawing operations. Drawing items using an alpha value normally requires mixing the content of the framebuffer with the item color. Mixing is done by using the alpha channel of the item color as intensity information for mixing the colors. After the drawing operation the alpha value is normally lost. But there could be situations where mixing is not wanted, for example when working with a multi layer hardware. If the alpha values of a bitmap or set by `GUI_SetAlpha()` should remain as alpha channel in the frame buffer this function should be called immediately before the drawing operation. To avoid unwanted behavior and side effects on other drawing operations it is recommended to disable that function after use.

#### Prototype

```
unsigned GUI_PreserveTrans(unsigned OnOff);
```

#### Parameters

Parameter	Description
<code>OnOff</code>	1 enables transparency preserving, 0 disables it.

#### Return value

Old state.

### 6.3.1.3.3 GUI\_RestoreUserAlpha()

#### Description

Restores the previous state of user alpha blending. Saved in the structure passed to the function.

#### Prototype

```
U32 GUI_RestoreUserAlpha(GUI_ALPHA_STATE * pAlphaState);
```

#### Parameters

Parameter	Description
<code>pAlphaState</code>	Pointer to a GUI_ALPHA_STATE structure containing information of the previous state to be restored.

#### Return value

Current user alpha value.

#### Example

```
GUI_ALPHA_STATE AlphaState;

GUI_EnableAlpha(1);
GUI_SetBkColor(GUI_WHITE);
GUI_Clear();
GUI_SetColor(GUI_BLACK);
GUI_DispStringHCenterAt("Alphablending", 45, 41);
GUI_SetUserAlpha(&AlphaState, 0xC0);
GUI_SetColor(GUI_RED);
GUI_FillRect(0, 0, 49, 49);
GUI_SetColor(GUI_GREEN);
GUI_FillRect(20, 20, 69, 69);
GUI_SetColor(GUI_BLUE);
GUI_FillRect(40, 40, 89, 89);
GUI_RestoreUserAlpha(&AlphaState);
```



### 6.3.1.3.4 GUI\_SetAlpha()

#### Description

Enables software alpha blending for all subsequent drawing operations.

#### Parameters

Parameter	Description
Alpha	Alpha value to be used for all subsequent drawing operations. Default is 0 which means no alpha blending.

#### Return value

Previous value used for alpha blending.

#### Additional information

The function sets the alpha value to be used for all subsequent drawing operations. A value of 0 for parameter Alpha means opaque (alpha blending disabled) and a value of 255 means completely transparent (invisible).

Note that software alpha blending increases the CPU load. Further it is strongly recommended to set the alpha value back to the default value after finishing the drawing operations.

#### Example

```
extern const GUI_BITMAP _LogoBitmap;
GUI_SetColor(GUI_BLUE);
GUI_FillCircle(100, 50, 49);
GUI_SetColor(GUI_YELLOW);
for (i = 0; i < 100; i++) {
    U8 Alpha;
    Alpha = (i * 255 / 100);
    GUI_SetAlpha(Alpha);
    GUI_DrawHLine(i, 100 - i, 100 + i);
}
GUI_SetAlpha(0x80);
GUI_DrawBitmap(&_LogoBitmap, 30, 30);
GUI_SetColor(GUI_MAGENTA);
GUI_SetFont(&GUI_Font24B_ASCII);
GUI_SetTextMode(GUI_TM_TRANS);
GUI_DispStringHCenterAt("Alphablending", 100, 3);
GUI_SetAlpha(0); /* Set back to default (opaque) */
```

#### Screenshot of above example



### 6.3.1.3.5 GUI\_SetUserAlpha()

#### Description

Sets an additional value which is used to calculate the actual alpha value to be used.

#### Prototype

```
U32 GUI_SetUserAlpha(GUI_ALPHA_STATE * pAlphaState,
                    U32 UserAlpha);
```

#### Parameters

Parameter	Description
<a href="#">pAlphaState</a>	Pointer to an GUI_ALPHA_STATE structure to be used to save the current state.
<a href="#">UserAlpha</a>	Value to be used.

#### Return value

Previous value used for alpha blending.

#### Additional information

The actual alpha value is calculated as follows:

$$\text{Alpha} = \text{AlphaFromObject} + ((255 - \text{AlphaFromObject}) * \text{UserAlpha}) / 255$$

The function GUI\_RestoreUserAlpha() can be used to restore the previous state of the function.



### 6.3.1.4 Drawing bitmaps

Generally emWin is able to display any bitmap image at any display position. On 16 bit CPUs (`sizeof(int) = 2`), the size of one bitmap per default is limited to 64 KB. If larger bitmaps should be displayed with a 16 bit CPU, refer to the chapter *Configuration* on page 109.

#### 6.3.1.4.1 GUI\_DrawBitmap()

##### Description

Draws a bitmap image at a specified position in the current window.

##### Prototype

```
void GUI_DrawBitmap(const GUI_BITMAP * pBitmap,
                   int          x0,
                   int          y0);
```

##### Parameters

Parameter	Description
<code>pBitmap</code>	Pointer to the bitmap to display.
<code>x</code>	X-position of the upper left corner of the bitmap in the display.
<code>y</code>	Y-position of the upper left corner of the bitmap in the display.

##### Additional information

The picture data is interpreted as bit stream starting with the most significant bit (msb) of the first byte. A new line always starts at an even byte address, as the *n* th line of the bitmap starts at offset (*n* \* BytesPerLine). The bitmap can be shown at any point in the client area. Usually, the Bitmap Converter is used to generate bitmaps. Detailed information can be found in the chapter *Bitmap Converter* on page 3112.

##### Example

```
extern const GUI_BITMAP bmSeggerLogoBlue; /* declare external Bitmap */

void main() {
    GUI_Init();
    GUI_DrawBitmap(&bmSeggerLogoBlue, 45, 20);
}
```

##### Screenshot of above example



### 6.3.1.4.2 GUI\_DrawBitmapEx()

#### Description

This routine makes it possible to scale and/or to mirror a bitmap on the display.

#### Prototype

```
void GUI_DrawBitmapEx(const GUI_BITMAP * pBitmap,
                    int x0,
                    int y0,
                    int xCenter,
                    int yCenter,
                    int xMag,
                    int yMag);
```

#### Parameters

Parameter	Description
<code>pBitmap</code>	Pointer to the bitmap to display.
<code>x0</code>	X-position of the anchor point in the display.
<code>y0</code>	Y-position of the anchor point in the display.
<code>xCenter</code>	X-position of the anchor point in the bitmap. Specifies the bitmap pixel of the bitmap which should be displayed at <code>x0</code> on the screen independent of scaling or mirroring.
<code>yCenter</code>	Y-position of the anchor point in the bitmap. Specifies the bitmap pixel of the bitmap which should be displayed at <code>y0</code> on the screen independent of scaling or mirroring.
<code>xMag</code>	Scale factor of X-direction in the unit 1/1000. A negative value mirrors the x-axis.
<code>yMag</code>	Scale factor of Y-direction in the unit 1/1000. A negative value mirrors the y-axis.

#### Additional information

This function can not be used to draw RLE-compressed bitmaps and bitmaps in the format A565.

### 6.3.1.4.3 GUI\_DrawBitmapMag()

#### Description

This routine makes it possible to magnify a bitmap on the display.

#### Prototype

```
void GUI_DrawBitmapMag(const GUI_BITMAP * pBitmap,  
                       int             x0,  
                       int             y0,  
                       int             xMul,  
                       int             yMul);
```

#### Parameters

Parameter	Description
<code>pBitmap</code>	Pointer to the bitmap to display.
<code>x0</code>	X-position of the upper left corner of the bitmap in the display.
<code>y0</code>	Y-position of the upper left corner of the bitmap in the display.
<code>XMul</code>	Magnification factor of X-direction.
<code>YMul</code>	Magnification factor of Y-direction.

#### 6.3.1.4.4 GUI\_SetAlphaMask8888()

##### Description

That routine takes only effect on drawing non compressed true color bitmaps (GUI\_DRAW\_BMP8888 and GUI\_DRAW\_BMPM8888I). It can be used to set additional masks used for drawing the pixels of a non compressed true color bitmap.

##### Prototype

```
void GUI_SetAlphaMask8888(U32 OrMask,  
                          U32 AndMask);
```

##### Parameters

Parameter	Description
<a href="#">OrMask</a>	Value to be OR combined with each pixel.
<a href="#">AndMask</a>	Value to be AND combined with each pixel.

### 6.3.1.5 Drawing streamed bitmaps

Streamed bitmaps can be located in addressable area (RAM or ROM) as well as external memory (e.g. on removable devices).

#### Drawing from addressable memory

There are 2 possibilities to display streamed bitmaps which are located on addressable memory. The first one is to use the function `GUI_DrawStreamedBitmap()` or the function `GUI_DrawStreamedBitmapAuto()`. The second one is to create a `GUI_BITMAP` according to the streamed bitmap and use it for a regular call of e.g. `GUI_DrawBitmap()`.

#### Drawing from external memory

Streamed bitmaps which are located on external memory can be drawn using the *...Ex() functions*. *...Ex() functions* require a pointer to a user defined `GetData()` function (see *FileAccess* on page 3219) in order to have emWin retrieve the stream self-dependently. If the format of the streamed bitmap is unknown at runtime, the function `GUI_DrawStreamedBitmapExAuto()` should be used.

#### Requirements

The *...Ex() functions* require to have enough free memory which is assigned to emWin to store at least one line of pixel data. If there is not enough free memory, the function will return immediately without having anything drawn. Using the *...Auto() function* causes the linker to add all functions referenced by the *...Auto() function*. If there is not enough memory the according function for the specific format should be used (e.g. `GUI_DrawStreamedBitmap565Ex()`).

#### Available bitmap formats

The following table shows the currently supported formats and the availability of according *...Ex() functions*:

Format	Description	...Ex() function available
IDX	Index based* bitmaps 1-8bpp.	Yes
444_12	12bpp Bitmaps, 4 bits blue, 4 bits green, 4 bits red.	Yes
444_12_1	12bpp Bitmaps, 4 bits blue, 4 bits green, 4 bits red.	Yes
444_16	12bpp Bitmaps, 4 bits blue, 4 bits green, 4 bits red.	Yes
M444_16	12bpp Bitmaps, 4 bits red, 4 bits green, 4 bits blue.	Yes
M444_12	12bpp Bitmaps, 4 bits red, 4 bits green, 4 bits blue.	Yes
M444_12_1	12bpp Bitmaps, 4 bits red, 4 bits green, 4 bits blue.	Yes
555	16bpp high color bitmaps, 5 bits blue, 5 bits green, 5 bits red.	Yes
M555	16bpp high color bitmaps, 5 bits red, 5 bits green, 5 bits blue.	Yes
565	16bpp high color bitmaps, 5 bits blue, 6 bits green, 5 bits red.	Yes
M565	16bpp high color bitmaps, 5 bits red, 6 bits green, 5 bits blue.	Yes
A555	16bpp high color bitmaps, 5 bits blue, 5 bits green, 5 bits red, 8 bit alpha channel	Yes
AM555	16bpp high color bitmaps, 5 bits red, 5 bits green, 5 bits blue, 8 bit alpha channel	Yes
A565	16bpp high color bitmaps, 5 bits blue, 6 bits green, 5 bits red, 8 bit alpha channel	Yes

Format	Description	...Ex() function available
AM565	16bpp high color bitmaps, 5 bits red, 6 bits green, 5 bits blue, 8 bit alpha channel	Yes
24	24bpp true color bitmaps, 8 bits blue, 8 bits green, 8 bits red.	Yes
Alpha	32bpp true color bitmaps, 8 bits alpha, 8 bits blue, 8 bits green, 8 bits red.	No
RLEAlpha	8bpp alpha channel bitmaps, compressed.	No
RLE1	1bpp index based bitmaps, RLE compressed.	No
RLE4	4bpp index based bitmaps, RLE compressed.	Yes
RLE8	8bpp index based bitmaps, RLE compressed.	Yes
RLE16	16bpp (565) high color bitmaps, RLE compressed.	Yes
RLEM16	16bpp (M565) high color bitmaps, RLE compressed.	Yes
RLE32	32bpp (8888) true color bitmaps with alpha channel, RLE compressed.	Yes

#### Note

\* Index based bitmaps consist of a palette of colors stated as 32bit values. All other bitmaps do not have a palette and therefore have the bitmap data stored in the format specified in the table.

### 6.3.1.5.1 GUI\_CreateBitmapFromStream()

#### Description

The function creates a bitmap structure by passing any type of bitmap stream.

#### Prototype

```
int GUI_CreateBitmapFromStream(      GUI_BITMAP      * pBMP,
                                   GUI_LOGPALETTE * pPAL,
                                   const void      * p);
```

#### Parameters

Parameter	Description
<code>pBMP</code>	Pointer to a <code>GUI_BITMAP</code> structure to be initialized by the function.
<code>pPAL</code>	Pointer to a <code>GUI_LOGPALETTE</code> structure to be initialized by the function.
<code>p</code>	Pointer to the data stream.

#### Return value

0        on success  
1        on error.

#### Additional information

This function should be used if the data stream can consist of several kinds of bitmap formats or unknown. Disadvantage of using this function is that it has a significant memory footprint. If memory usage (ROM) is a concern, it may be better to use the format specific functions below. All pointers passed to this function have to remain valid as long as the bitmap should be used (e.g. take care if using stack variables).

#### Example

The following example shows how the `GUI_CreateBitmapFromStream()` functions can be used to create and draw a bitmap:

```
void DrawBitmap(const void * pData, int xPos, int yPos) {
    GUI_BITMAP      Bitmap;
    GUI_LOGPALETTE Palette;

    GUI_CreateBitmapFromStream(&Bitmap, &Palette, pData);
    GUI_DrawBitmap(&Bitmap, xPos, yPos);
}
```

- 6.3.1.5.2 GUI\_CreateBitmapFromStreamIDX()
- 6.3.1.5.3 GUI\_CreateBitmapFromStreamRLE1()
- 6.3.1.5.4 GUI\_CreateBitmapFromStreamRLE4()
- 6.3.1.5.5 GUI\_CreateBitmapFromStreamRLE8()
- 6.3.1.5.6 GUI\_CreateBitmapFromStream444\_12()
- 6.3.1.5.7 GUI\_CreateBitmapFromStream444\_12\_1()
- 6.3.1.5.8 GUI\_CreateBitmapFromStreamM444\_12()
- 6.3.1.5.9 GUI\_CreateBitmapFromStreamM444\_12\_1()
- 6.3.1.5.10 GUI\_CreateBitmapFromStream444\_16()
- 6.3.1.5.11 GUI\_CreateBitmapFromStreamM444\_16()
- 6.3.1.5.12 GUI\_CreateBitmapFromStreamA555()
- 6.3.1.5.13 GUI\_CreateBitmapFromStreamAM555()
- 6.3.1.5.14 GUI\_CreateBitmapFromStreamA565()
- 6.3.1.5.15 GUI\_CreateBitmapFromStreamAM565()
- 6.3.1.5.16 GUI\_CreateBitmapFromStream565()
- 6.3.1.5.17 GUI\_CreateBitmapFromStreamM565()
- 6.3.1.5.18 GUI\_CreateBitmapFromStream555()
- 6.3.1.5.19 GUI\_CreateBitmapFromStreamM555()
- 6.3.1.5.20 GUI\_CreateBitmapFromStreamRLE16()
- 6.3.1.5.21 GUI\_CreateBitmapFromStreamRLEM16()
- 6.3.1.5.22 GUI\_CreateBitmapFromStream24()
- 6.3.1.5.23 GUI\_CreateBitmapFromStreamAlpha()
- 6.3.1.5.24 GUI\_CreateBitmapFromStreamRLEAlpha()
- 6.3.1.5.25 GUI\_CreateBitmapFromStreamRLE32()

### Description

These functions create bitmap structures by passing bitmap streams of a known format.

### Prototype

```
int GUI_CreateBitmapFromStream<FORMAT>(          GUI_BITMAP      * pBMP,
                                               GUI_LOGPALETTE * pPAL,
                                               const void      * p);
```



## Parameters

Parameter	Description
<code>pBMP</code>	Pointer to a <code>GUI_BITMAP</code> structure to be initialized by the function.
<code>pPAL</code>	Pointer to a <code>GUI_LOGPALETTE</code> structure to be initialized by the function.
<code>p</code>	Pointer to the data stream.

## Supported data stream formats

The following table shows the supported data stream formats for each function:

Function	Supported stream format
<code>GUI_CreateBitmapFromStreamIDX()</code>	Streams of index based bitmaps.
<code>GUI_CreateBitmapFromStreamRLE1()</code>	Streams of RLE1 compressed bitmaps.
<code>GUI_CreateBitmapFromStreamRLE4()</code>	Streams of RLE4 compressed bitmaps.
<code>GUI_CreateBitmapFromStreamRLE8()</code>	Streams of RLE8 compressed bitmaps.
<code>GUI_CreateBitmapFromStreamA555()</code>	Streams of high color bitmaps with alpha channel (A555).
<code>GUI_CreateBitmapFromStreamAM555()</code>	Streams of high color bitmaps with alpha channel (AM555).
<code>GUI_CreateBitmapFromStreamA565()</code>	Streams of high color bitmaps with alpha channel (A565).
<code>GUI_CreateBitmapFromStreamAM565()</code>	Streams of high color bitmaps with alpha channel (AM565).
<code>GUI_CreateBitmapFromStream444_12()</code>	Streams 12bpp bitmaps (444_12).
<code>GUI_CreateBitmapFromStream444_12_1()</code>	Streams 12bpp bitmaps (444_12_1).
<code>GUI_CreateBitmapFromStream444_16()</code>	Streams 12bpp bitmaps (444_16).
<code>GUI_CreateBitmapFromStreamM444_12()</code>	Streams 12bpp bitmaps (M444_12).
<code>GUI_CreateBitmapFromStreamM444_12_1()</code>	Streams 12bpp bitmaps (M444_12_1).
<code>GUI_CreateBitmapFromStreamM444_16()</code>	Streams 12bpp bitmaps (M444_16).
<code>GUI_CreateBitmapFromStream565()</code>	Streams of high color bitmaps (565).
<code>GUI_CreateBitmapFromStreamM565()</code>	Streams of high color bitmaps (M565).
<code>GUI_CreateBitmapFromStream555()</code>	Streams of high color bitmaps (555).
<code>GUI_CreateBitmapFromStreamM555()</code>	Streams of high color bitmaps (M555).
<code>GUI_CreateBitmapFromStreamRLE16()</code>	Streams of RLE16 compressed bitmaps.
<code>GUI_CreateBitmapFromStreamRLEM16()</code>	Streams of RLE16 compressed bitmaps, red and blue swapped.
<code>GUI_CreateBitmapFromStream24()</code>	Streams of 24bpp bitmaps (true color).
<code>GUI_CreateBitmapFromStreamAlpha()</code>	Streams of 32bpp bitmaps (true color with alpha channel).
<code>GUI_CreateBitmapFromStreamRLEAlpha()</code>	Streams of RLE compressed 8bpp alpha bitmaps.
<code>GUI_CreateBitmapFromStreamRLE32()</code>	Streams of RLE32 compressed bitmaps (true color with alpha channel).

## Return value

- 0 On success.
- 1 On error.

**Additional information**

These functions should be used if the data stream consists of a known format. This avoids linking of unused code and keeps the binary code small.

### 6.3.1.5.26 GUI\_DrawStreamedBitmap()

#### Description

Draws a bitmap from an indexed based bitmap data stream. Note that this routine **only** works for indexed bitmap streams. If the format is not known, `GUI_DrawStreamedBitmapAuto()` should be used. Alternatively, `GUI_DrawStreamedBitmapXXX()` with the corresponding format can be used.

#### Prototype

```
void GUI_DrawStreamedBitmap(const void * p,
                           int      x,
                           int      y);
```

#### Parameters

Parameter	Description
<code>p</code>	Pointer to the data stream.
<code>x</code>	X-position of the upper left corner of the bitmap in the display.
<code>y</code>	Y-position of the upper left corner of the bitmap in the display.

#### Additional information

The Bitmap Converter can be used to create bitmap data streams. The format of these streams does not equal the format of a bmp file. Details can be found in the chapter *Bitmap Converter* on page 3112.

### 6.3.1.5.27 GUI\_DrawStreamedBitmapAuto()

#### Description

Draws a bitmap from a bitmap data stream of any supported format.

#### Prototype

```
void GUI_DrawStreamedBitmapAuto(const void * p,  
                                int      x,  
                                int      y);
```

#### Parameters

Parameter	Description
<code>p</code>	Pointer to the data stream.
<code>x</code>	X-position of the upper left corner of the bitmap in the display.
<code>y</code>	Y-position of the upper left corner of the bitmap in the display.

#### Additional information

Additional information can be found under `GUI_DrawStreamedBitmap()`.

### 6.3.1.5.28 GUI\_DrawStreamedBitmapEx()

#### Description

This function can be used for drawing index based bitmap data streams if not enough RAM or ROM is available to keep the whole file within the addressable memory (RAM or ROM). The GUI library calls the function pointed by the parameter `pfGetData` to read the data. This GetData function needs to return the number of read bytes.

#### Prototype

```
int GUI_DrawStreamedBitmapEx(      GUI_DTA_GET_DATA_FUNC * pfGetData,
                                  const void          * p,
                                  int                  x,
                                  int                  y);
```

#### Parameters

Parameter	Description
<code>pfGetData</code>	<b>in</b> Function pointer to a GetData function. For more details, please refer to the chapter <i>FileAccess</i> on page 3219.
<code>p</code>	<b>in</b> Void pointer passed to the function pointed by <code>pfGetData</code> .
<code>x</code>	X-position of the upper left corner of the bitmap in the display.
<code>y</code>	Y-position of the upper left corner of the bitmap in the display.

#### Return value

0        on success  
1        on error.

#### Additional information

The function requires at least memory for one line of bitmap data. For more details please also refer to the function `GUI_SetStreamedBitmapHook()`.

### 6.3.1.5.29 GUI\_DrawStreamedBitmapExAuto()

#### Description

This function can be used for drawing bitmap data streams of any supported format if not enough RAM or ROM is available to keep the whole file within the addressable memory (RAM or ROM). The GUI library calls the function pointed by the parameter `pfGetData` to read the data. This GetData function needs to return the number of read bytes.

#### Prototype

```
int GUI_DrawStreamedBitmapExAuto(    GUI_DTA_GET_DATA_FUNC * pfGetData,
                                   const void * p,
                                   int x,
                                   int y);
```

#### Parameters

Parameter	Description
<code>pfGetData</code>	<b>in</b> Function pointer to a GetData function. For more details, please refer to the chapter <i>FileAccess</i> on page 3219.
<code>p</code>	<b>in</b> Void pointer passed to the function pointed by <code>pfGetData</code> .
<code>x</code>	X-position of the upper left corner of the bitmap in the display.
<code>y</code>	Y-position of the upper left corner of the bitmap in the display.

#### Return value

0        on success  
1        on error.

#### Additional information

The function requires at least memory for one line of bitmap data.

- 6.3.1.5.30 GUI\_DrawStreamedBitmapA555Ex()
- 6.3.1.5.31 GUI\_DrawStreamedBitmapAM555Ex()
- 6.3.1.5.32 GUI\_DrawStreamedBitmapA565Ex()
- 6.3.1.5.33 GUI\_DrawStreamedBitmapAM565Ex()
- 6.3.1.5.34 GUI\_DrawStreamedBitmap555Ex()
- 6.3.1.5.35 GUI\_DrawStreamedBitmapM555Ex()
- 6.3.1.5.36 GUI\_DrawStreamedBitmap565Ex()
- 6.3.1.5.37 GUI\_DrawStreamedBitmapM565Ex()
- 6.3.1.5.38 GUI\_DrawStreamedBitmap24Ex()

### Description

This function can be used for drawing bitmap data streams of the respective format if not enough RAM or ROM is available to keep the whole file within the addressable memory (RAM or ROM). The GUI library calls the function pointed by the parameter `pfGetData` to read the data. This `GetData` function needs to return the number of read bytes.

### Prototype

```
int GUI_DrawStreamedBitmap<XXX>Ex(    GUI_DTA_GET_DATA_FUNC * pfGetData,
                                     const void * p,
                                     int x,
                                     int y);
```

### Parameters

Parameter	Description
<code>pfGetData</code>	<b>in</b> Function pointer to a <code>GetData</code> function. For more details, please refer to the chapter <i>FileAccess</i> on page 3219.
<code>p</code>	<b>in</b> Void pointer passed to the function pointed by <code>pfGetData</code> .
<code>x</code>	X-position of the upper left corner of the bitmap in the display.
<code>y</code>	Y-position of the upper left corner of the bitmap in the display.

### Return value

- 0 On success.
- 1 On error.

### Additional information

The functions require at least memory for one line of bitmap data.

### 6.3.1.5.39 GUI\_GetStreamedBitmapInfo()

#### Description

Returns a structure with information about the given data stream.

#### Prototype

```
void GUI_GetStreamedBitmapInfo(const void * p,  
                               GUI_BITMAPSTREAM_INFO * pInfo);
```

#### Parameters

Parameter	Description
<code>p</code>	Pointer to the data stream.
<code>pInfo</code>	Pointer to a GUI_BITMAPSTREAM_INFO structure to be filled by the function.



### 6.3.1.5.40 GUI\_GetStreamedBitmapInfoEx()

#### Description

Returns a structure with information about the given data stream which does not need to be located in the addressable ROM or RAM area of the CPU.

#### Prototype

```
int GUI_GetStreamedBitmapInfoEx(      GUI_DTA_GET_DATA_FUNC * pfGetData,
                                     const void * p,
                                     GUI_BITMAPSTREAM_INFO * pInfo);
```

#### Parameters

Parameter	Description
<code>pfGetData</code>	<b>in</b> Function pointer to a GetData function. For more details, please refer to the chapter <i>FileAccess</i> on page 3219.
<code>p</code>	<b>in</b> Void pointer passed to the function pointed by <code>pfGetData</code> .
<code>pInfo</code>	Pointer to a <code>GUI_BITMAPSTREAM_INFO</code> structure to be filled by the function.

#### Return value

0        on success  
1        on error.

#### Elements of structure GUI\_BITMAPSTREAM\_INFO

The elements of the structure `GUI_BITMAPSTREAM_INFO` are listed under *GUI\_GetStreamedBitmapInfo* on page 376.

### 6.3.1.5.41 GUI\_SetStreamedBitmapHook()

#### Description

Sets a hook function to be able to manipulate the palette of a streamed bitmap which is not located in the addressable area of the CPU. The hook function is called when executing `GUI_DrawStreamedBitmapEx()`.

#### Prototype

```
void GUI_SetStreamedBitmapHook(GUI_BITMAPSTREAM_CALLBACK pfStreamedBitmapHook);
```

#### Parameters

Parameter	Description
<code>pfStreamedBitmapHook</code>	Hook function to be called by <code>GUI_DrawStreamedBitmapEx()</code> .

#### Prototype of hook function

```
void * Hook(GUI_BITMAPSTREAM_PARAM * pParam);
```

#### Parameters

Parameter	Description
<code>pParam</code>	Pointer to a <code>GUI_BITMAPSTREAM_PARAM</code> structure

#### Example

```
static void * _cbStreamedBitmapHook(GUI_BITMAPSTREAM_PARAM * pParam) {
    void * p = NULL;
    int    i, NumColors;
    U32    Color;
    U32 * pColor;
    switch (pParam->Cmd) {
    case GUI_BITMAPSTREAM_GET_BUFFER:
        //
        // Allocate buffer for palette data
        //
        p = malloc(pParam->v);
        break;
    case GUI_BITMAPSTREAM_RELEASE_BUFFER:
        //
        // Release buffer
        //
        free(pParam->p);
        break;
    case GUI_BITMAPSTREAM_MODIFY_PALETTE:
        //
        // Do something with the palette...
        //
        NumColors = pParam->v;
        pColor    = (U32 *)pParam->p;
        Color     = *(pColor + pParam->v - 1);
        for (i = NumColors - 2; i >= 0; i--) {
            *(pColor + i + 1) = *(pColor + i);
        }
        *pColor = Color;
        break;
    }
    return p;
}
```

### 6.3.1.6 Drawing lines

The most frequently used drawing routines are those that draw a line from one point to another.

### 6.3.1.6.1 GUI\_DrawHLine()

#### Description

Draws a horizontal line one pixel thick from a specified starting point to a specified endpoint in the current window.

#### Prototype

```
void GUI_DrawHLine(int y0,  
                  int x0,  
                  int x1);
```

#### Parameters

Parameter	Description
y	Y-position.
x0	X-starting position.
x1	X-end position.

#### Additional information

If  $x1 < x0$ , nothing will be displayed.

With most LCD controllers, this routine is executed very quickly because multiple pixels can be set at once and no calculations are needed. If it is clear that horizontal lines are to be drawn, this routine executes faster than the `GUI_DrawLine()` routine.

### 6.3.1.6.2 GUI\_DrawLine()

#### Description

Draws a line from a specified starting point to a specified endpoint in the current window (absolute coordinates).

#### Prototype

```
void GUI_DrawLine(int x0,  
                 int y0,  
                 int x1,  
                 int y1);
```

#### Parameters

Parameter	Description
x0	X-starting position.
y0	Y-starting position.
x1	X-end position.
y1	Y-end position.

#### Additional information

If part of the line is not visible because it is not in the current window or because part of the current window is not visible, this is due to clipping.

### 6.3.1.6.3 GUI\_DrawLineRel()

#### Description

Draws a line from the current (x, y) position to an endpoint specified by X-distance and Y-distance in the current window (relative coordinates).

#### Prototype

```
void GUI_DrawLineRel(int dx,  
                    int dy);
```

#### Parameters

Parameter	Description
<code>dx</code>	Distance in X-direction to end of line to draw.
<code>dy</code>	Distance in Y-direction to end of line to draw.

#### 6.3.1.6.4 GUI\_DrawLineTo()

##### Description

Draws a line from the current (X,Y) position to an endpoint specified by X- and Y-coordinates in the current window.

##### Prototype

```
void GUI_DrawLineTo(int x,  
                   int y);
```

##### Parameters

Parameter	Description
x	X-end position.
y	Y-end position.

### 6.3.1.6.5 GUI\_DrawPolyLine()

#### Description

Connects a predefined list of points with lines in the current window.

#### Prototype

```
void GUI_DrawPolyLine(const GUI_POINT * pPoints,  
                      int           NumPoints,  
                      int           x0,  
                      int           y0);
```

#### Parameters

Parameter	Description
<code>pPoint</code>	Pointer to the polyline to display.
<code>NumPoints</code>	Number of points specified in the list of points.
<code>x</code>	X-position of origin.
<code>y</code>	Y-position of origin.

#### Additional information

The starting point and endpoint of the polyline do not need to be identical.



### 6.3.1.6.6 GUI\_DrawVLine()

#### Description

Draws a vertical line one pixel thick from a specified starting point to a specified endpoint in the current window.

#### Prototype

```
void GUI_DrawVLine(int x0,  
                  int y0,  
                  int y1);
```

#### Parameters

Parameter	Description
x0	X-position.
y0	Y-starting position.
y1	Y-end position.

#### Additional information

If  $y1 < y0$ , nothing will be displayed. With most LCD controllers, this routine is executed very quickly because multiple pixels can be set at once and no calculations are needed. If it is clear that vertical lines are to be drawn, this routine executes faster than the `GUI_DrawLine()` routine.

### 6.3.1.6.7 GUI\_GetLineStyle()

#### Description

Returns the current line style used by the function `GUI_DrawLine`.

#### Prototype

```
U8 GUI_GetLineStyle(void);
```

#### Return value

Current line style used by the function `GUI_DrawLine`.

### 6.3.1.6.8 GUI\_MoveRel()

#### Description

Moves the current line pointer relative to its current position.

#### Prototype

```
void GUI_MoveRel(int dx,  
                int dy);
```

#### Parameters

Parameter	Description
<code>dx</code>	Distance to move in X.
<code>dy</code>	Distance to move in Y.

#### Related topics

- [GUI\\_DrawLineTo](#) on page 383
- [GUI\\_MoveTo](#) on page 388

### 6.3.1.6.9 GUI\_MoveTo()

#### Description

Moves the current line pointer to the given position.

#### Prototype

```
void GUI_MoveTo(int x,  
               int y);
```

#### Parameters

Parameter	Description
<code>x</code>	New position in X.
<code>y</code>	New position in Y.

### 6.3.1.6.10 GUI\_SetLineStyle()

#### Description

Sets the current line style used by the function `GUI_DrawLine()`.

#### Prototype

```
U8 GUI_SetLineStyle(U8 LineStyle);
```

#### Parameters

Parameter	Description
<code>LineStyle</code>	New line style to be used. A full list of available values can be found under <i>Line styles</i> on page 444.

#### Return value

Previous line style used by the function `GUI_DrawLine()`.

#### Additional information

This function sets only the line style used by `GUI_DrawLine()`. The style will be used only with a pen size of 1.

### 6.3.1.7 Drawing polygons

The polygon drawing routines can be helpful when drawing vectorized symbols.

#### 6.3.1.7.1 GUI\_DrawPolygon()

##### Description

Draws the outline of a polygon defined by a list of points in the current window.

##### Prototype

```
void GUI_DrawPolygon(const GUI_POINT * pPoints,  
                    int NumPoints,  
                    int x0,  
                    int y0);
```

##### Parameters

Parameter	Description
<code>pPoint</code>	Pointer to the polygon to display.
<code>NumPoints</code>	Number of points specified in the list of points.
<code>x</code>	X-position of origin.
<code>y</code>	Y-position of origin.

##### Additional information

The polyline drawn is automatically closed by connecting the endpoint to the starting point.

### 6.3.1.7.2 GUI\_EnlargePolygon()

#### Description

Enlarges a polygon on all sides by a specified length in pixels.

#### Prototype

```
void GUI_EnlargePolygon(    GUI_POINT * pDest,
                          const GUI_POINT * pSrc,
                          int          NumPoints,
                          int          Len);
```

#### Parameters

Parameter	Description
<code>pDest</code>	Pointer to the destination polygon.
<code>pSrc</code>	Pointer to the source polygon.
<code>NumPoints</code>	Number of points specified in the list of points.
<code>Len</code>	Length (in pixels) by which to enlarge the polygon.

#### Additional information

Make sure the destination array of points is equal to or larger than the source array.

#### Example

```
const GUI_POINT aPoints[] = {
    { 40, 20},
    { 0, 20},
    { 20, 0}
};
GUI_POINT aEnlargedPoints[GUI_COUNTOF(aPoints)];
void Sample(void) {
    int i;
    GUI_Clear();
    GUI_SetDrawMode(GUI_DM_XOR);
    GUI_FillPolygon(aPoints, GUI_COUNTOF(aPoints), 140, 110);
    for (i = 1; i < 10; i++) {
        GUI_EnlargePolygon(aEnlargedPoints, aPoints, GUI_COUNTOF(aPoints), i * 5);
        GUI_FillPolygon(aEnlargedPoints, GUI_COUNTOF(aPoints), 140, 110);
    }
}
```

#### Screenshot of above example



### 6.3.1.7.3 GUI\_FillPolygon()

#### Description

Draws a filled polygon defined by a list of points in the current window.

#### Prototype

```
void GUI_FillPolygon(const GUI_POINT * pPoints,  
                    int NumPoints,  
                    int x0,  
                    int y0);
```

#### Parameters

Parameter	Description
<code>pPoint</code>	Pointer to the destination polygon.
<code>NumPoints</code>	Number of points specified in the list of points.
<code>x</code>	X-position of origin.
<code>y</code>	Y-position of origin.

#### Additional information

The polyline drawn is automatically closed by connecting the endpoint to the starting point. It is not required that the endpoint touches the outline of the polygon. Rendering a polygon is done by drawing one or more horizontal lines for each `y`-position of the polygon.



### 6.3.1.7.4 GUI\_MagnifyPolygon()

#### Description

Magnifies a polygon by a specified factor.

#### Prototype

```
void GUI_MagnifyPolygon(    GUI_POINT * pDest,
                          const GUI_POINT * pSrc,
                          int          NumPoints,
                          int          Mag);
```

#### Parameters

Parameter	Description
<code>pDest</code>	Pointer to the destination polygon.
<code>pSrc</code>	Pointer to the source polygon.
<code>NumPoints</code>	Number of points specified in the list of points.
<code>Mag</code>	Factor used to magnify the polygon.

#### Additional information

Make sure the destination array of points is equal to or larger than the source array. Note the difference between enlarging and magnifying a polygon. Calling the function `GUI_EnlargePolygon()` with the parameter `Len = 1` will enlarge the polygon by one pixel on all sides, whereas the call of `GUI_MagnifyPolygon()` with the parameter `Mag = 1` will have no effect.

#### Example

```
const GUI_POINT aPoints[] = {
    { 0, 20},
    { 40, 20},
    { 20, 0}
};
GUI_POINT aMagnifiedPoints[GUI_COUNTOF(aPoints)];
void Sample(void) {
    int Mag, y = 0, Count = 4;
    GUI_Clear();
    GUI_SetColor(GUI_GREEN);
    for (Mag = 1; Mag <= 4; Mag *= 2, Count /= 2) {
        int i, x = 0;
        GUI_MagnifyPolygon(aMagnifiedPoints, aPoints, GUI_COUNTOF(aPoints), Mag);
        for (i = Count; i > 0; i--, x += 40 * Mag) {
            GUI_FillPolygon(aMagnifiedPoints, GUI_COUNTOF(aPoints), x, y);
        }
        y += 20 * Mag;
    }
}
```

**Screenshot of above example**

### 6.3.1.7.5 GUI\_RotatePolygon()

#### Description

Rotates a polygon by a specified angle.

#### Prototype

```
void GUI_RotatePolygon(    GUI_POINT * pDest,
                          const GUI_POINT * pSrc,
                          int          NumPoints,
                          float       Angle);
```

#### Parameters

Parameter	Description
<code>pDest</code>	Pointer to the destination polygon.
<code>pSrc</code>	Pointer to the source polygon.
<code>NumPoints</code>	Number of points specified in the list of points.
<code>Angle</code>	<code>Angle</code> in radian used to rotate the polygon.

#### Additional information

Make sure the destination array of points is equal to or larger than the source array.

#### Example

The following example shows how to draw a polygon. It is available as `2DGL_DrawPolygon.c` in the examples shipped with emWin.

```
#include "GUI.h"
/*****
 *
 *           The points of the arrow
 */
static const GUI_POINT aPointArrow[] = {
    { 0, -5},
    {-40, -35},
    {-10, -25},
    {-10, -85},
    { 10, -85},
    { 10, -25},
    { 40, -35},
};
static GUI_POINT aPointRotate[GUI_COUNTOF(aPointArrow)];
/*****
 *
 *           Draws a polygon
 */
static void DrawPolygon(void) {
    int r;
    int Cnt = 0;
    GUI_SetBkColor(GUI_WHITE);
    GUI_Clear();
    GUI_SetFont(&GUI_Font8x16);
    GUI_SetColor(0x0);
    GUI_DispStringAt("Polygons of arbitrary shape ", 0, 0);
    GUI_DispStringAt("in any color", 120, 20);
    GUI_SetColor(GUI_BLUE);
    /* Rotate and draw polygon */
    r = 45.0 / (2.0 * 3.141592);
    GUI_RotatePolygon(&aPointRotate[0], &aPointArrow[0], GUI_COUNTOF(aPointArrow), r);
    GUI_FillPolygon (&aPointRotate[0], 7, 100, 100);
}
/*****
```

```
*
*           main
*/
void main(void) {
    GUI_Init();
    DrawPolygon();
    while(1)
        GUI_Delay(100);
}
```

### Screenshot of above example

**Polygons of arbitrary shape  
in any color**

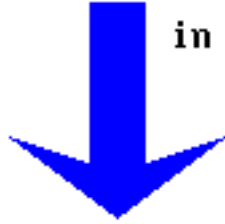

## 6.3.1.8 Drawing circles

### 6.3.1.8.1 GUI\_DrawCircle()

#### Description

Draws the outline of a circle of specified dimensions, at a specified position in the current window.

#### Prototype

```
void GUI_DrawCircle(int x0,  
                   int y0,  
                   int r);
```

#### Parameters

Parameter	Description
<code>x0</code>	X-position of the center of the circle in pixels of the client window.
<code>y0</code>	Y-position of the center of the circle in pixels of the client window.
<code>r</code>	Radius of the circle (half the diameter). Must be a positive value.

#### Example

```
for (i = 10; i < 50; i += 3) {  
    GUI_DrawCircle(120, 60, i);  
}
```

#### Screenshot of above example

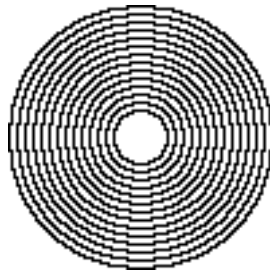

### 6.3.1.8.2 GUI\_FillCircle()

#### Description

Draws a filled circle of specified dimensions at a specified position in the current window.

#### Prototype

```
void GUI_FillCircle(int x0,  
                  int y0,  
                  int r);
```

#### Parameters

Parameter	Description
<code>x0</code>	X-position of the center of the circle in pixels of the client window.
<code>y0</code>	Y-position of the center of the circle in pixels of the client window.
<code>r</code>	Radius of the circle (half the diameter). Must be a positive value.

#### Example

```
GUI_FillCircle(120,60,50);
```

#### Screenshot of above example



## 6.3.1.9 Drawing ellipses

### 6.3.1.9.1 GUI\_DrawEllipse()

#### Description

Draws the outline of an ellipse of specified dimensions, at a specified position in the current window.

#### Prototype

```
void GUI_DrawEllipse(int x0,  
                    int y0,  
                    int rx,  
                    int ry);
```

#### Parameters

Parameter	Description
<code>x0</code>	X-position of the center of the circle in pixels of the client window.
<code>y0</code>	Y-position of the center of the circle in pixels of the client window.
<code>rx</code>	X-radius of the ellipse (half the diameter). Must be a positive value.
<code>ry</code>	Y-radius of the ellipse (half the diameter). Must be a positive value.

#### Additional information

This routine is based on integer calculation. Too large ellipses cause overflows which lead to unexpected results. In that case `GUI_DrawEllipseXL()` should be used instead.

#### Example

See the `GUI_FillEllipse` on page 401 example.

### 6.3.1.9.2 GUI\_DrawEllipseXL()

#### Description

Draws the outline of a large ellipse.

#### Prototype

```
void GUI_DrawEllipseXL(int x0,  
                      int y0,  
                      int rx,  
                      int ry);
```

#### Parameters

Parameter	Description
<code>x0</code>	X-position of the center of the circle in pixels of the client window.
<code>y0</code>	Y-position of the center of the circle in pixels of the client window.
<code>rx</code>	X-radius of the ellipse (half the diameter). Must be a positive value.
<code>ry</code>	Y-radius of the ellipse (half the diameter). Must be a positive value.



### 6.3.1.9.3 GUI\_FillEllipse()

#### Description

Draws a filled ellipse of specified dimensions at a specified position in the current window.

#### Prototype

```
void GUI_FillEllipse(int x0,  
                    int y0,  
                    int rx,  
                    int ry);
```

#### Parameters

Parameter	Description
<code>x0</code>	X-position of the center of the circle in pixels of the client window.
<code>y0</code>	Y-position of the center of the circle in pixels of the client window.
<code>rx</code>	X-radius of the ellipse (half the diameter). Must be a positive value.
<code>ry</code>	Y-radius of the ellipse (half the diameter). Must be a positive value.

#### Example

```
// Demo ellipses  
GUI_SetColor(0xff);  
GUI_FillEllipse(100, 180, 50, 70);  
GUI_SetColor(0x0);  
GUI_DrawEllipse(100, 180, 50, 70);  
GUI_SetColor(0x000000);  
GUI_FillEllipse(100, 180, 10, 50);
```

#### Screenshot of above example



## 6.3.1.10 Drawing arcs

### 6.3.1.10.1 GUI\_DrawArc()

#### Description

Draws an arc of specified dimensions at a specified position in the current window. An arc is a section of the outline of a circle.

#### Prototype

```
void GUI_DrawArc(int x0,
                 int y0,
                 int rx,
                 int ry,
                 int a0,
                 int a1);
```

#### Parameters

Parameter	Description
<code>x0</code>	Horizontal position of the center in pixels of the client window.
<code>y0</code>	Vertical position of the center in pixels of the client window.
<code>rx</code>	X-radius (pixels).
<code>ry</code>	Y-radius (pixels). Currently this parameter is not used. The <code>rx</code> parameter is used instead.
<code>a0</code>	Starting angle (degrees).
<code>a1</code>	Ending angle (degrees).

#### Additional information

There are two things to note about the angle parameters `a0` and `a1`:

- emWin uses a counter-clockwise angle measurement.
- The starting angle `a0` must always be lower than the ending angle `a1`.

The image below demonstrates the counter-clockwise angle measurement and shows where the angles are located on the circular axis.

Marked in red is an example arc with starting angle `a0 = 0°` and ending angle `a1 = 120°`.

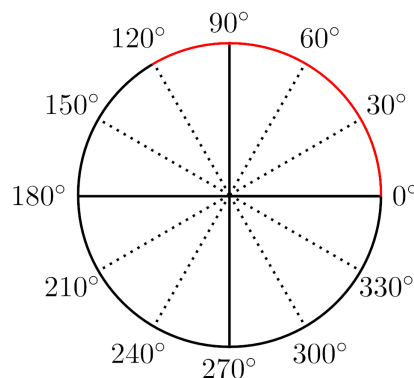

#### Example

```
void DrawArcScale(void) {
    int x0 = 160;
    int y0 = 180;
    int i;
    char ac[4];
```

```

GUI_SetBkColor(GUI_WHITE);
GUI_Clear();
GUI_SetPenSize( 5 );
GUI_SetTextMode(GUI_TM_TRANS);
GUI_SetFont(&GUI_FontComic18B_ASCII);
GUI_SetColor( GUI_BLACK );
GUI_DrawArc( x0,y0,150, 150,-30, 210 );
GUI_Delay(1000);
for (i=0; i<= 23; i++) {
    float a = (-30+i*10)*3.1415926/180;
    int x = -141*cos(a)+x0;
    int y = -141*sin(a)+y0;
    if (i%2 == 0)
        GUI_SetPenSize( 5 );
    else
        GUI_SetPenSize( 4 );
    GUI_DrawPoint(x,y);
    if (i%2 == 0) {
        x = -123*cos(a)+x0;
        y = -130*sin(a)+y0;
        sprintf(ac, "%d", 10*i);
        GUI_SetTextAlign(GUI_TA_VCENTER);
        GUI_DispStringHCenterAt(ac,x,y);
    }
}
}
}

```

**Screenshot of above example**

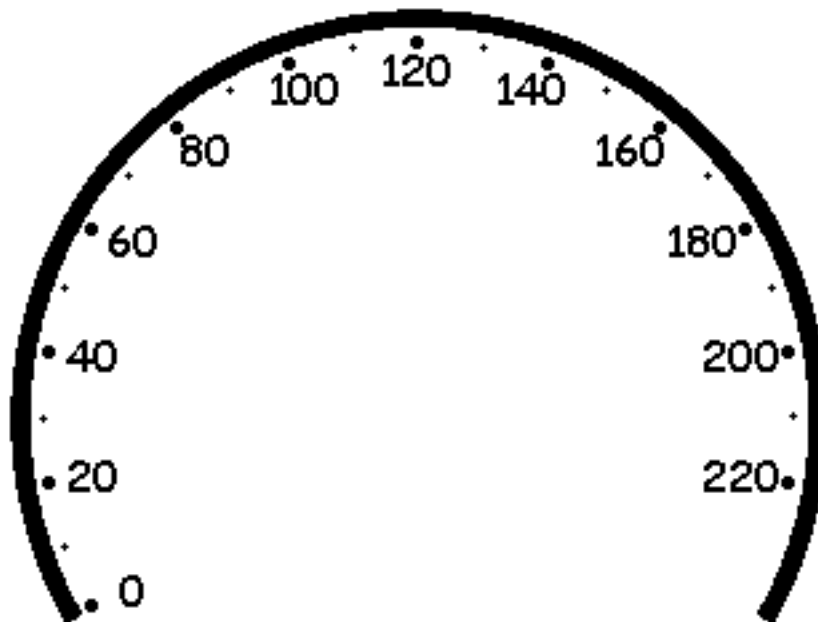

### 6.3.1.10.2 GUI\_DrawArcHR()

#### Description

Draws an arc of specified dimensions at a specified position in the current window. An arc is a section of the outline of a circle.

#### Prototype

```
void GUI_DrawArcHR(int x0,  
                  int y0,  
                  int rx,  
                  int ry,  
                  int a0,  
                  int a1);
```

#### Parameters

Parameter	Description
x0	Horizontal position of the center in pixels of the client window.
y0	Vertical position of the center in pixels of the client window.
rx	X-radius (pixels).
ry	Y-radius (pixels).
a0	Starting angle (degrees * 1000).
a1	Ending angle (degrees * 1000).

### 6.3.1.10.3 GUI\_DrawArcHREx()

#### Description

Draws an arc with optionally rounded ends. An arc is a section of the outline of a circle.

#### Prototype

```
void GUI_DrawArcHREx(int x0,  
                    int y0,  
                    int r,  
                    int a0,  
                    int a1,  
                    int c0,  
                    int c1);
```

#### Parameters

Parameter	Description
x0	Horizontal position of the center in pixels of the client window.
y0	Vertical position of the center in pixels of the client window.
r	Radius (in px).
a0	Starting angle (degrees * 1000).
a1	Ending angle (degrees * 1000).
c0	1 if start of arc should be rounded, 0 if not.
c1	1 if end of arc should be rounded, 0 if not.

## 6.3.1.11 Drawing graphs

### 6.3.1.11.1 GUI\_DrawGraph()

#### Description

Draws a graph at once.

#### Prototype

```
void GUI_DrawGraph(I16 * paY,
                  int   NumPoints,
                  int   x0,
                  int   y0);
```

#### Parameters

Parameter	Description
<code>paY</code>	Pointer to an array containing the Y-values of the graph.
<code>NumPoints</code>	Number of Y-values to be displayed.
<code>x0</code>	Starting point in x.
<code>y0</code>	Starting point in y.

#### Additional information

The function first sets the line-cursor to the position specified with `x0`, `y0` and the first Y-value of the given array. Then it starts drawing lines to `x0 + 1`, `y0 + *(paY + 1)`, `x0 + 2`, `y0 + *(paY + 2)` and so on.

#### Example

```
#include "GUI.h"
#include <stdlib.h>
I16 aY[100];
void MainTask(void) {
    int i;
    GUI_Init();
    for (i = 0; i < GUI_COUNTOF(aY); i++) {
        aY[i] = rand() % 50;
    }
    GUI_DrawGraph(aY, GUI_COUNTOF(aY), 0, 0);
}
```

#### Screenshot of above example



### 6.3.1.12 Drawing barcodes

#### 6.3.1.12.1 GUI\_BARCODE\_Draw()

##### Description

Draws a barcode of the given type at the specified position.

##### Prototype

```
int GUI_BARCODE_Draw(    int    xPos,
                        int    yPos,
                        int    ModuleSize,
                        int    ySize,
                        int    Type,
                        const char * sBarcode);
```

##### Parameters

Parameter	Description
xPos	X-position to be used.
yPos	Y-position to be used.
ModuleSize	Size of one module, that means width of the smallest bar in pixels
ySize	Y-size of the barcode. Cannot be lower than three times the module size.
Type	Type of the barcode to be drawn. See full list of available values under <i>Barcode types</i> on page 441.
sBarcode	String containing the data to be used for the barcode. The ITF barcode can only display numbers.

##### Return value

- 0 on success
- 1 on error.

##### Additional information

The data string for ITF barcodes should contain an even amount of numbers. If it does not, a leading zero will be added to the code automatically due to technical limitations.



##### Note

Barcodes can be drawn in any color. But please note that the contrast between bars and spaces has to be high enough so the code can be read successfully by a scanner. We recommend using the 'standard' colors barcodes consist of, which are white for the background (spaces) and black for the foreground (bars).

##### Examples

```
GUI_SetColor(GUI_BLACK);
GUI_SetBkColor(GUI_WHITE);
GUI_BARCODE_Draw(0, 0, 3, 60, GUI_BARCODE_ITF, "131072");
GUI_BARCODE_Draw(0, 0, 2, 60, GUI_BARCODE_128, "SEGGGER");
```

**Screenshots of above examples**

GUI_BARCODE_ITF	GUI_BARCODE_128
 A barcode consisting of vertical black bars of varying widths on a white background, representing the ITF (Interleaved 2 of 5) format.	 A barcode consisting of vertical black bars of varying widths on a white background, representing the 128 (Code 128) format.



### 6.3.1.12.2 GUI\_BARCODE\_GetXSize()

#### Description

Returns the X-size of a given barcode without drawing it.

#### Prototype

```
int GUI_BARCODE_GetXSize(    int    Type,  
                             int    ModuleSize,  
                             const char * sBarcode);
```

#### Parameters

Parameter	Description
Type	Type of the barcode to be drawn. See list below.
ModuleSize	Size of one module, that means width of the smallest bar in pixels.
sBarcode	String containing the data to be used for the barcode. The ITF barcode can only display numbers.

#### Return value

X-size of the barcode on success, -1 on error.

### 6.3.1.13 Drawing QR codes



It should be made sure of that the QR code is surrounded by a bright colored frame of at least the pixel size of one 'module'. Alternatively, `GUI_QR_CreateFramed()` may be called to draw a QR code with the white frame around it.

#### 6.3.1.13.1 Memory requirement

This formula calculates the approx. number of required bytes for a QR bitmap.

```
NumReqBytes = (sqrt(((4 * Version) + 17) * Pixelsize) / 8) + 48
```

### 6.3.1.13.2 GUI\_QR\_Create()

#### Description

Creates an QR-code bitmap which can be drawn with `GUI_QR_Draw()`.

#### Prototype

```
GUI_HMEM GUI_QR_Create(const char * pText,
                      int      PixelSize,
                      int      EccLevel,
                      int      Version);
```

#### Parameters

Parameter	Description
<code>pText</code>	UTF-8 text to be used for the QR-code.
<code>PixelSize</code>	Size in pixels of one 'Module'.
<code>EccLevel</code>	Error correction level to be used. See full list of available values under <i>ECC levels for QR codes</i> on page 443.
<code>Version</code>	Desired size in modules of the QR-code. If set to 0 (recommended) the size will be calculated automatically. Must be between 1 and 40. If it is less than required for the given text with the given <code>EccLevel</code> , the function fails.

#### Return value

Valid handle on success, 0 on error.

#### Additional information

After the QR code is no longer used, it should be deleted with `GUI_QR_Delete()`.

### 6.3.1.13.3 GUI\_QR\_CreateFramed()

#### Description

Creates an QR-code bitmap which can be drawn with `GUI_QR_Draw()`. A white frame by the size of one module will be added.

#### Prototype

```
GUI_HMEM GUI_QR_CreateFramed(const char * pText,
                             int      PixelSize,
                             int      EccLevel,
                             int      Version);
```

#### Parameters

Parameter	Description
<code>pText</code>	UTF-8 text to be used for the QR-code.
<code>PixelSize</code>	Size in pixels of one 'Module'.
<code>EccLevel</code>	Error correction level to be used. See full list of available values under <i>ECC levels for QR codes</i> on page 443.
<code>Version</code>	Desired size in modules of the QR-code. If set to 0 (recommended) the size will be calculated automatically. Must be between 1 and 40. If it is less than required for the given text with the given <code>EccLevel</code> , the function fails.

#### Return value

Valid handle on success, 0 on error.

#### Additional information

After the QR code is no longer used, it should be deleted with `GUI_QR_Delete()`.

### 6.3.1.13.4 GUI\_QR\_Delete()

#### Description

Frees the memory used for the QR-code.

#### Prototype

```
void GUI_QR_Delete(GUI_HMEM hQR);
```

#### Parameters

Parameter	Description
<a href="#">hQR</a>	Handle of the QR-code to be deleted.

#### Additional information

A QR-code should be removed if it is no longer used.

### 6.3.1.13.5 GUI\_QR\_Draw()

#### Description

Draws the given QR-code at the given pixel position.

#### Prototype

```
void GUI_QR_Draw(GUI_HMEM hQR,  
                 int       xPos,  
                 int       yPos);
```

#### Parameters

Parameter	Description
<code>hQR</code>	Handle of the QR-code to be drawn.
<code>xPos</code>	X-position to be used.
<code>yPos</code>	Y-position to be used.

### 6.3.1.13.6 GUI\_QR\_GetInfo()

#### Description

Returns a structure containing information about the given QR-code.

#### Prototype

```
void GUI_QR_GetInfo(GUI_HMEM      hQR,  
                   GUI_QR_INFO * pInfo);
```

#### Parameters

Parameter	Description
<code>hQR</code>	Handle of the QR-code to be deleted.
<code>pInfo</code>	Pointer to a structure of type <code>GUI_QR_INFO</code>

## 6.3.1.14 Drawing pie charts

### 6.3.1.14.1 GUI\_DrawPie()

#### Description

Draws a circle sector.

#### Prototype

```
void GUI_DrawPie(int x0,
                int y0,
                int r,
                int a0,
                int a1,
                int Type);
```

#### Parameters

Parameter	Description
<code>x0</code>	X-position of the center of the circle in pixels of the client window.
<code>y0</code>	Y-position of the center of the circle in pixels of the client window.
<code>r</code>	Radius of the circle (half the diameter).
<code>a0</code>	Starting angle (degrees).
<code>a1</code>	End angle (degrees).
<code>Type</code>	(reserved for future use, should be 0)

#### Example

```
int i, a0, a1;
const unsigned aValues[] = { 100, 135, 190, 240, 340, 360};
const GUI_COLOR aColors[] = { GUI_BLUE, GUI_GREEN, GUI_RED,
                              GUI_CYAN, GUI_MAGENTA, GUI_YELLOW };
for (i = 0; i < GUI_COUNTOF(aValues); i++) {
    a0 = (i == 0) ? 0 : aValues[i - 1];
    a1 = aValues[i];
    GUI_SetColor(aColors[i]);
    GUI_DrawPie(100, 100, 50, a0, a1, 0);
}
```

#### Screenshot of above example





### 6.3.1.14.2 GUI\_DrawPieHR()

#### Description

Draws a circle sector.

#### Prototype

```
void GUI_DrawPieHR(int x0,  
                  int y0,  
                  int r,  
                  I32 a0,  
                  I32 a1);
```

#### Parameters

Parameter	Description
<code>x0</code>	X-position of the center of the circle in pixels of the client window.
<code>y0</code>	Y-position of the center of the circle in pixels of the client window.
<code>r</code>	Radius of the circle (half the diameter).
<code>a0</code>	Starting angle (degrees * 1000).
<code>a1</code>	End angle (degrees * 1000).

### 6.3.1.15 Drawing splines

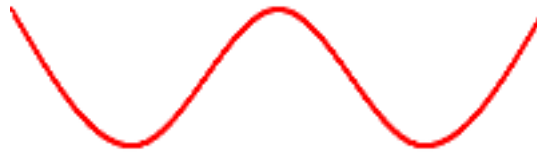

#### 6.3.1.15.1 GUI\_SPLINE\_Create()

##### Description

This function creates a spline handle with the given parameters.

##### Prototype

```
GUI_HMEM GUI_SPLINE_Create(const int      * px,  
                           const int      * py,  
                           unsigned       NumPoints);
```

##### Parameters

Parameter	Description
<code>px</code>	Pointer to an array of values for x coordinates.
<code>py</code>	Pointer to an array of values for y coordinates.
<code>NumPoints</code>	Number of points to be used.

##### Return value

A handle of a spline. If zero, creation failed.

##### Additional information

The amount of points for x and y coordinates have to be the same. Please note that the values for the x coordinates have to be in a increasing order. It is not possible to create a spline where `px[0] > px[1]`.

### 6.3.1.15.2 GUI\_SPLINE\_Delete()

#### Description

This function deletes the memory allocated for a spline while it was created.

#### Prototype

```
void GUI_SPLINE_Delete(GUI_HMEM hSpline);
```

#### Parameters

Parameter	Description
<a href="#">hSpline</a>	Handle of the spline to be deleted.

### 6.3.1.15.3 GUI\_SPLINE\_Draw()

#### Description

This function draws a spline created with `GUI_SPLINE_Create()` at the given position.

#### Prototype

```
void GUI_SPLINE_Draw(GUI_HMEM hSpline,  
                    int        x,  
                    int        y);
```

#### Parameters

Parameter	Description
<code>hSpline</code>	Handle of a spline.
<code>x</code>	Position in <code>x</code> .
<code>y</code>	Position in <code>y</code> .

### 6.3.1.15.4 GUI\_SPLINE\_DrawAA()

#### Description

This function draws a spline created with `GUI_SPLINE_Create()` at the given position using anti aliasing.

#### Prototype

```
void GUI_SPLINE_DrawAA(GUI_HMEM hSpline,  
                       int        x,  
                       int        y,  
                       unsigned Width);
```

#### Parameters

Parameter	Description
<code>hSpline</code>	Handle of a spline.
<code>x</code>	Position in <code>x</code> .
<code>y</code>	Position in <code>y</code> .
<code>Width</code>	<code>Width</code> of the spline to be drawn.

#### Additional information

The color which is used to mix the anti aliased pixels with can be set using `GUI_SetBkColor()`. This only makes sense on a solid colored background. If the background consists of multiple colors the draw mode should be set to transparent by a call of `GUI_SetDrawMode(GUI_TM_TRANS)`.

### 6.3.1.15.5 GUI\_SPLINE\_GetY()

#### Description

This function returns the y coordinate corresponding to the given Index.

#### Prototype

```
I16 GUI_SPLINE_GetY(GUI_HMEM hSpline,  
                   unsigned Index,  
                   float * py);
```

#### Parameters

Parameter	Description
<a href="#">hSpline</a>	Handle of a spline.
<a href="#">Index</a>	Position in x.
<a href="#">py</a>	Outpointer to store the y value as floating value (can be NULL).

#### Return value

The y value corresponding to the given index value.

#### Additional information

IT is possible to use either the return value or if a higher precision is required the value stored in the third parameter. If the return value of this function is sufficient in regards of precision the last parameter can be NULL.

### 6.3.1.15.6 GUI\_SPLINE\_GetXSize()

#### Description

This function returns the X-size required for the spline to be drawn.

#### Prototype

```
unsigned GUI_SPLINE_GetXSize(GUI_HMEM hSpline);
```

#### Parameters

Parameter	Description
<a href="#">hSpline</a>	Handle of a spline.

#### Return value

X-size in pixel required to draw the complete spline.

## 6.3.1.16 YUV device

### 6.3.1.16.1 GUI\_YUV\_Create()

#### Description

Creates a YUV device in the current layer. For details please refer to `GUI_YUV_CreateEx()`.

#### Prototype

```
int GUI_YUV_Create(void);
```

#### Return value

= 0      if successful.  
≠ 0      if the creation fails.



### 6.3.1.16.2 GUI\_YUV\_CreateEx()

#### Description

Creates a YUV device in the given layer with the given period. It allocates an additional buffer for a YUV plane for the complete given layer. Memory requirement is 2 bytes per pixel. Please note that YUV devices are supported only for display drivers with direct interface like GUIDRV\_Lin. In the given period it (re)calculates the 'dirty' framebuffer area from RGB data into YUV data.

#### Prototype

```
int GUI_YUV_CreateEx(int LayerIndex,  
                    unsigned Period);
```

#### Parameters

Parameter	Description
<code>LayerIndex</code>	The layer to be used.
<code>Period</code>	The period in ms to be used.

#### Return value

= 0 if successful.  
≠ 0 if the creation fails.

#### Additional information

Please note that the calculation from RGB to YUV requires a lot of CPU load.

### 6.3.1.16.3 GUI\_YUV\_Delete()

#### Description

Deletes the YUV device of the current layer.

#### Prototype

```
int GUI_YUV_Delete(void);
```

#### Return value

= 0      if successful.  
≠ 0      on error.

### 6.3.1.16.4 GUI\_YUV\_DeleteEx()

#### Description

Deletes the YUV device of the given layer.

#### Prototype

```
int GUI_YUV_DeleteEx(int LayerIndex);
```

#### Parameters

Parameter	Description
<code>LayerIndex</code>	The layer to be used.

#### Return value

= 0      if successful.  
≠ 0      on error.

### 6.3.1.16.5 GUI\_YUV\_GetpData()

#### Description

Returns a pointer to the YUV plane of the current layer and the size of the plane in bytes.

#### Prototype

```
U32 *GUI_YUV_GetpData(U32 * pSize);
```

#### Parameters

Parameter	Description
<code>pSize</code>	Pointer to a U32 value for returning the plane size.

#### Return value

Pointer to the YUV plane.

### 6.3.1.16.6 GUI\_YUV\_GetpDataEx()

#### Description

Returns a pointer to the YUV plane of the given layer and the size of the plane in bytes.

#### Prototype

```
U32 *GUI_YUV_GetpDataEx(int LayerIndex,  
                        U32 * pSize);
```

#### Parameters

Parameter	Description
<code>LayerIndex</code>	The layer to be used.
<code>pSize</code>	Pointer to a U32 value for returning the plane size.

#### Return value

Pointer to the YUV plane.

### 6.3.1.16.7 GUI\_YUV\_InvalidateArea()

#### Description

Invalidates the given area of the current layer. During the next interval that area will be (re)calculated.

#### Prototype

```
void GUI_YUV_InvalidateArea(int x,  
                           int y,  
                           int xSize,  
                           int ySize);
```

#### Parameters

Parameter	Description
<code>x</code>	X-position in pixels.
<code>y</code>	Y-position in pixels.
<code>xSize</code>	X-size in pixels.
<code>ySize</code>	Y-size in pixels.

### 6.3.1.16.8 GUI\_YUV\_SetPeriod()

#### Description

Sets the recalculation period of the YUV device in the current layer.

#### Prototype

```
int GUI_YUV_SetPeriod(unsigned Period);
```

#### Parameters

Parameter	Description
<code>Period</code>	The period in ms to be used

#### Return value

= 0      if successful.  
≠ 0      on error.

### 6.3.1.16.9 GUI\_YUV\_SetPeriodEx()

#### Description

Sets the period to be used for (re)calculation.

#### Prototype

```
int GUI_YUV_SetPeriodEx(int LayerIndex,  
                        unsigned Period);
```

#### Parameters

Parameter	Description
LayerIndex	The layer to be used
Period	The period in ms to be used

#### Return value

= 0 if successful.  
≠ 0 on error.



## 6.3.1.17 Data structures

### 6.3.1.17.1 GUI\_ALPHA\_STATE

#### Description

Used for storing the alpha value with `GUI_SetUserAlpha()`.

#### Type definition

```
typedef struct {  
    U32  UserAlpha;  
} GUI_ALPHA_STATE;
```

#### Structure members

Member	Description
<a href="#">UserAlpha</a>	Alpha value to be used.

#### See also

- `GUI_SetUserAlpha()`

### 6.3.1.17.2 GUI\_BITMAPSTREAM\_INFO

#### Description

Information about a streamed bitmap.

#### Type definition

```
typedef struct {
    int XSize;
    int YSize;
    int BitsPerPixel;
    int NumColors;
    int HasTrans;
} GUI_BITMAPSTREAM_INFO;
```

#### Structure members

Member	Description
<a href="#">XSize</a>	Pixel size in X of the image.
<a href="#">YSize</a>	Pixel size in Y of the image.
<a href="#">BitsPerPixel</a>	Number of bits per pixel.
<a href="#">NumColors</a>	Number of colors in case of an index based image.
<a href="#">HasTrans</a>	In case of an index based image 1 if transparency exist, 0 if not.

#### See also

- [GUI\\_GetStreamedBitmapInfo\(\)](#)
- [GUI\\_GetStreamedBitmapInfoEx\(\)](#)

### 6.3.1.17.3 GUI\_BITMAPSTREAM\_PARAM

#### Description

Contains a command to be used by a set hook function for GUI\_DrawStreamedBitmapEx().

#### Type definition

```
typedef struct {
    int    Cmd;
    U32    v;
    void * p;
} GUI_BITMAPSTREAM_PARAM;
```

#### Structure members

Member	Description
Cmd	Command to be executed.
v	Depends on the command to be executed.
p	Depends on the command to be executed.

Supported values for member Cmd	
GUI_BITMAPSTREAM_GET_BUFFER	When receiving this command the application can spend a buffer for the palette of a bitmap stream. Parameters: p - Pointer to the buffer or NULL v - Requested buffer size
GUI_BITMAPSTREAM_RELEASE_BUFFER	If the application has spend a buffer for the palette here the buffer should be released. Parameters: p - Pointer to buffer to be released v - not used
GUI_BITMAPSTREAM_MODIFY_PALETTE	This command is sent after loading the palette and before drawing the image to be able to modify the palette of the streamed image. Parameters: p - Pointer to palette data v - Number of colors in palette

#### See also

- GUI\_SetStreamedBitmapHook()

### 6.3.1.17.4 GUI\_GRADIENT\_INFO

#### Description

Information used for drawing multi-color gradients.

#### Type definition

```
typedef struct {
    U16      Pos;
    GUI_COLOR Color;
} GUI_GRADIENT_INFO;
```

#### Structure members

Member	Description
<code>Pos</code>	Start position of color. The next entry is the end position. The last entry also defines the x1 / y1 position of the gradient, either if it's a horizontal or vertical gradient.
<code>Color</code>	<code>Color</code> to be used.

#### Additional information

The member `Pos` is used to define the start and end position of the colors. It defines also the size of the gradient.

#### See also

- `GUI_DrawGradientMH()`
- `GUI_DrawGradientMV()`
- `GUI_DrawGradientMHEX()`
- `GUI_DrawGradientMVEX()`

### 6.3.1.17.5 GUI\_POINT

#### Description

Implementation of a point on the screen.

#### Type definition

```
typedef struct {  
    I16P x;  
    I16P y;  
} GUI_POINT;
```

#### Structure members

Member	Description
<a href="#">x</a>	X-position of the point.
<a href="#">y</a>	Y-position of the point.

### 6.3.1.17.6 GUI\_QR\_INFO

#### Description

Information about a QR code.

#### Type definition

```
typedef struct {  
    int Version;  
    int Width;  
    int Size;  
} GUI_QR_INFO;
```

#### Structure members

Member	Description
<a href="#">Version</a>	<a href="#">Version</a> according to QR code documentation.
<a href="#">Width</a>	Number of 'Modules'.
<a href="#">Size</a>	<a href="#">Size</a> of bitmap in pixels.

#### See also

- [GUI\\_QR\\_GetInfo\(\)](#)

### 6.3.1.17.7 GUI\_RECT

#### Description

Implementation of a rectangle on the screen.

#### Type definition

```
typedef struct {  
    I16 x0;  
    I16 y0;  
    I16 x1;  
    I16 y1;  
} GUI_RECT;
```

#### Structure members

Member	Description
x0	X-position of top left point of the rectangle.
y0	Y-position of top left point of the rectangle.
x1	X-position of bottom right point of the rectangle.
y1	Y-position of bottom right point of the rectangle.

## 6.3.1.18 Defines

### 6.3.1.18.1 Axis values

#### Description

Defines to distinguish between the X and Y axis. Used in various emWin functions.

#### Definition

```
#define GUI_COORD_X    0
#define GUI_COORD_Y    1
```

#### Symbols

Definition	Description
<a href="#">GUI_COORD_X</a>	X axis.
<a href="#">GUI_COORD_Y</a>	Y axis.



### 6.3.1.18.2 Barcode types

#### Description

Type of barcode to be drawn.

#### Definition

```
#define GUI_BARCODE_ITF      0
#define GUI_BARCODE_128    1
```

#### Symbols

Definition	Description
<a href="#">GUI_BARCODE_ITF</a>	<b>Interleaved 2 of 5 (ITF)</b> which can display an even amount of digits.
<a href="#">GUI_BARCODE_128</a>	<b>Code128</b> which can display all 128 ASCII characters.

### 6.3.1.18.3 Drawing modes

#### Description

These flags define the mode to be used for drawing operations.

#### Definition

```
#define GUI_DM_NORMAL      (0)
#define GUI_DM_XOR        (1 << 0)
#define GUI_DM_TRANS      (1 << 1)
#define GUI_DM_REV        (1 << 2)
```

#### Symbols

Definition	Description
<code>GUI_DM_NORMAL</code>	Default: The content of the display is overdrawn by the graphic.
<code>GUI_DM_XOR</code>	The content of the display is inverted when it is overdrawn. Restrictions are listed below.
<code>GUI_DM_TRANS</code>	When drawing shapes with a background and foreground color the background color will be transparent.
<code>GUI_DM_REV</code>	Swaps background and foreground color.

#### Restrictions

- XOR mode is useful only when using two displayed colors inside the active window or screen.
- Functions which make use of the pen size might not work properly if the drawing mode is XOR and the pen size is unequal to 1. So before using one of those functions either the drawing mode should be set to NORMAL or the pen size should be set to 1. The functions which regard the pen size are listed in the description of *GUI\_SetPenSize* on page 326.
- When drawing bitmaps with a color depth greater than 1 bit per pixel (bpp) this drawing mode takes no effect.
- When using drawing functions such as `GUI_DrawPolyLine()` or multiple calls of `GUI_DrawLineTo()`, the fulcrums are inverted twice. The result is that these pixels remain in the background color.

### 6.3.1.18.4 ECC levels for QR codes

#### Description

Error correction level to be used by the Reed-Solomon error correction for a QR code.

#### Definition

```
#define GUI_QR_ECLEVEL_L 0
#define GUI_QR_ECLEVEL_M 1
#define GUI_QR_ECLEVEL_Q 2
#define GUI_QR_ECLEVEL_H 3
```

#### Symbols

Definition	Description
<a href="#">GUI_QR_ECLEVEL_L</a>	About 7% or less errors can be corrected.
<a href="#">GUI_QR_ECLEVEL_M</a>	About 15% or less errors can be corrected.
<a href="#">GUI_QR_ECLEVEL_Q</a>	About 25% or less errors can be corrected.
<a href="#">GUI_QR_ECLEVEL_H</a>	About 30% or less errors can be corrected.

### 6.3.1.18.5 Line styles

#### Description

Style how a line is drawn.

#### Definition

```
#define GUI_LS_SOLID      (0)
#define GUI_LS_DASH      (1)
#define GUI_LS_DOT       (2)
#define GUI_LS_DASHDOT   (3)
#define GUI_LS_DASHDOTDOT (4)
```

#### Symbols

Definition	Description
<a href="#">GUI_LS_SOLID</a>	Lines are drawn solid (default).
<a href="#">GUI_LS_DASH</a>	Lines are drawn dashed.
<a href="#">GUI_LS_DOT</a>	Lines are drawn dotted.
<a href="#">GUI_LS_DASHDOT</a>	Lines are drawn alternating with dashes and dots.
<a href="#">GUI_LS_DASHDOTDOT</a>	Lines are drawn alternating with dashes and double dots.

## 6.3.1.19 Prototypes

### 6.3.1.19.1 GUI\_DTA\_GET\_DATA\_FUNC

#### Description

GetData function used for streamed bitmaps (DTA), for more details see GUI\_GET\_DATA\_FUNC\_II.

#### Type definition

```
typedef GUI_GET_DATA_FUNC_II GUI_DTA_GET_DATA_FUNC;
```

## 6.4 Displaying bitmap files

The recommended and most efficient way to display a bitmap known at compile time is to use the Bitmap Converter to convert it into a C file and add it to the project / make-file. Details about the Bitmap Converter can be found in the chapter *Bitmap Converter* on page 3112.

If the application needs to display images not known at compile time, the image needs to be available in a graphic file format supported by emWin. In this case, the image file can reside in memory or on an other storage device; it can be displayed even if the amount of available memory is less than the size of the image file. emWin currently supports BMP-, JPEG- and GIF-files. PNG-file support can be achieved by adding the PNG-library available [on our website](#) which comes with its own BSD style license. More details about PNG support can be found under *PNG file support* on page 496.

## 6.4.1 BMP file support

Although bitmaps which can be used with emWin are normally compiled and linked as C files with the application, there may be situations when using these types of structures is not desirable. A typical example would be an application that continuously references new images, such as bitmaps downloaded by the user. The following functions support `bmp` files which have been loaded into memory.

For images that you plan to re-use (e.g. a company logo) it is much more efficient to compile and link it as C file which can be used directly by emWin. This may be easily done with the Bitmap Converter.

### 6.4.1.1 Supported formats

The BMP file format has been defined by Microsoft. emWin supports the BMP file format version 3. That contains a couple of different image formats shown in the table below:

Bits per pixel	Indexed	Compression	Supported
1	yes	no	yes
4	yes	no	yes
4	yes	yes	yes
8	yes	no	yes
8	yes	yes	yes
16	no	no	yes
24	no	no	yes
32	no	no	yes

### 6.4.1.2 BMP API

The table below lists the available BMP file related routines in alphabetical order. Detailed function descriptions follow:

#### Functions

Routine	Description
<code>GUI_BMP_Draw()</code>	Draws a BMP file which has been loaded into memory.
<code>GUI_BMP_DrawEx()</code>	Draws a BMP file which does not need to be loaded into memory.
<code>GUI_BMP_DrawScaled()</code>	Draws a BMP file with scaling which has been loaded into memory.
<code>GUI_BMP_DrawScaledEx()</code>	Draws a BMP file with scaling which does not need to be loaded into memory.
<code>GUI_BMP_EnableAlpha()</code>	Enables alpha channel for 32bpp V3 BMP files.
<code>GUI_BMP_GetXSize()</code>	Returns the X-size of a BMP file loaded into memory.
<code>GUI_BMP_GetXSizeEx()</code>	Returns the X-size of a BMP file which does not need to be loaded into memory.
<code>GUI_BMP_GetYSize()</code>	Returns the Y-size of a bitmap loaded into memory.
<code>GUI_BMP_GetYSizeEx()</code>	Returns the Y-size of a BMP file which does not need to be loaded into memory.
<code>GUI_BMP_Serialize()</code>	Creates a BMP file.
<code>GUI_BMP_SerializeEx()</code>	Creates a BMP file from the given rectangle.

Routine	Description
<a href="#">GUI_BMP_SerializeExBpp()</a>	Creates a BMP file from the given rectangle using the specified color depth.

## Prototypes

Prototype	Description
<a href="#">GUI_BMP_GET_DATA_FUNC</a>	GetData function used for the BMP format, for more details see <a href="#">GUI_GET_DATA_FUNC_I</a> .



## 6.4.1.2.1 Functions

### 6.4.1.2.1.1 GUI\_BMP\_Draw()

#### Description

Draws a Windows bmp file, which has been loaded into memory, at a specified position in the current window.

#### Prototype

```
int GUI_BMP_Draw(const void * pBMP,
                 int      x0,
                 int      y0);
```

#### Parameters

Parameter	Description
<code>pBMP</code>	Pointer to the start of the memory area in which the bmp file resides.
<code>x0</code>	X-position of the upper left corner of the bitmap in the display.
<code>y0</code>	Y-position of the upper left corner of the bitmap in the display.

#### Return value

= 0        on success.  
 ≠ 0        if the function fails.

#### Additional information

The table at the beginning of the chapter shows the supported BMP file formats. The example `2DGL_DrawBMP.c` shows how to use the function.

### 6.4.1.2.1.2 GUI\_BMP\_DrawEx()

#### Description

Draws a bmp file, which does not have to be loaded into memory, at a specified position in the current window.

#### Prototype

```
int GUI_BMP_DrawEx(GUI_BMP_GET_DATA_FUNC * pfGetData,
                  void * p,
                  int x0,
                  int y0);
```

#### Parameters

Parameter	Description
<code>pfGetData</code>	<b>in</b> Function pointer to a GetData function. For more details, please refer to the chapter <i>FileAccess</i> on page 3219.
<code>p</code>	<b>in</b> Void pointer passed to the function pointed by <code>pfGetData</code> .
<code>x0</code>	X-position of the upper left corner of the bitmap in the display.
<code>y0</code>	Y-position of the upper left corner of the bitmap in the display.

#### Return value

= 0      on success.  
 ≠ 0      if the function fails.

#### Additional information

This function is used for drawing bmp files if not enough RAM is available to load the whole file into memory. The GUI library then calls the function pointed by the parameter `pfGetData` to read the data. The GetData function needs to return the number of requested bytes. The maximum number of bytes requested by the GUI is the number of bytes needed for drawing one line of the image.

### 6.4.1.2.1.3 GUI\_BMP\_DrawScaled()

#### Description

Draws a bmp file, which has been loaded into memory, at a specified position in the current window using scaling.

#### Prototype

```
int GUI_BMP_DrawScaled(const void * pFileData,
                      int x0,
                      int y0,
                      int Num,
                      int Denom);
```

#### Parameters

Parameter	Description
<code>pFileData</code>	Pointer to the start of the memory area in which the bmp file resides.
<code>x0</code>	X-position of the upper left corner of the bitmap in the display.
<code>y0</code>	Y-position of the upper left corner of the bitmap in the display.
<code>Num</code>	Numerator to be used for scaling.
<code>Denom</code>	Denominator used for scaling.

#### Return value

= 0      on success.  
 ≠ 0      if the function fails.

#### Additional information

The function scales the image by building a fraction with the given numerator and denominator. If for example an image should be shrunk to 2/3 of size the parameter `Num` should be 2 and `Denom` should be 3.

### 6.4.1.2.1.4 GUI\_BMP\_DrawScaledEx()

#### Description

Draws a bmp file, which does not have to be loaded into memory, at a specified position in the current window using scaling.

#### Prototype

```
int GUI_BMP_DrawScaledEx(GUI_BMP_GET_DATA_FUNC * pfGetData,
                        void * p,
                        int x0,
                        int y0,
                        int Num,
                        int Denom);
```

#### Parameters

Parameter	Description
<code>pfGetData</code>	<b>in</b> Function pointer to a GetData function. For more details, please refer to the chapter <i>FileAccess</i> on page 3219.
<code>p</code>	<b>in</b> Void pointer passed to the function pointed by <code>pfGetData</code> .
<code>x0</code>	X-position of the upper left corner of the bitmap in the display.
<code>y0</code>	Y-position of the upper left corner of the bitmap in the display.
<code>Num</code>	Numerator to be used for scaling.
<code>Denom</code>	Denominator used for scaling.

#### Return value

= 0      on success.  
 ≠ 0      if the function fails.

#### Additional information

The function scales the image by building a fraction with the given numerator and denominator. If for example an image should be shrunk to 2/3 of size the parameter `Num` should be 2 and `Denom` should be 3. For more details, refer to `GUI_BMP_DrawEx()`.

### 6.4.1.2.1.5 GUI\_BMP\_EnableAlpha()

#### Description

Enables semi-transparency for BMP files with a color depth of 32bpp.

#### Prototype

```
void GUI_BMP_EnableAlpha(void);
```

#### Additional information

The BMP file format has been defined 1990 by Microsoft. The version of that format is V3. There do not exist earlier versions. In the further course Microsoft defined V4 (with Windows 95) and V5 (with Windows 98). But applications with support for those formats are very rarely. Unfortunately the defacto standard V3 does not support semi-transparency, whereas V4 and V5 offers that feature.

The bitmap converter of emWin is able to save images with alpha channel as 32bpp BMP-file. It simply preserves the alpha values in the upper 8 bits of each pixel. These bits are not used in the V3 standard for 32bpp BMP-files. To be able to draw this kind of images saved by the BitmapConverter `GUI_BMP_EnableAlpha()` needs to be called. It should be mentioned that this kind of alpha channel support is not the same as defined in the newer versions V4 and V5.

Using `GUI_BMP_EnableAlpha()` makes only sense, if the alpha channel of 32bpp BMP-files is definitively used, because observing the alpha channel decreases the drawing performance slightly.

### 6.4.1.2.1.6 GUI\_BMP\_GetXSize()

#### Description

Returns the X-size of a specified bitmap which has been loaded into memory.

#### Prototype

```
int GUI_BMP_GetXSize(const void * pBMP);
```

#### Parameters

Parameter	Description
<code>pBMP</code>	Pointer to the start of the memory area in which the bmp file resides.

#### Return value

X-size of the bitmap.

### 6.4.1.2.1.7 GUI\_BMP\_GetXSizeEx()

#### Description

Returns the X-size of a specified bmp file which does not have to be loaded into memory.

#### Prototype

```
int GUI_BMP_GetXSizeEx(GUI_BMP_GET_DATA_FUNC * pfGetData,  
                      void * p);
```

#### Parameters

Parameter	Description
<code>pfGetData</code>	<b>in</b> Function pointer to a GetData function. For more details, please refer to the chapter <i>FileAccess</i> on page 3219.
<code>p</code>	<b>in</b> Void pointer passed to the function pointed by <code>pfGetData</code> .

#### Return value

X-size of the bitmap.

### 6.4.1.2.1.8 GUI\_BMP\_GetYSize()

#### Description

Returns the Y-size of a specified bitmap which has been loaded into memory.

#### Prototype

```
int GUI_BMP_GetYSize(const void * pBMP);
```

#### Parameters

Parameter	Description
<code>pBMP</code>	Pointer to the start of the memory area in which the bmp file resides.

#### Return value

Y-size of the bitmap.



### 6.4.1.2.1.9 GUI\_BMP\_GetYSizeEx()

#### Description

Returns the Y-size of a specified bmp file which does not have to be loaded into memory.

#### Prototype

```
int GUI_BMP_GetYSizeEx(GUI_BMP_GET_DATA_FUNC * pfGetData,  
                      void * p);
```

#### Parameters

Parameter	Description
<code>pfGetData</code>	<b>in</b> Function pointer to a GetData function. For more details, please refer to the chapter <i>FileAccess</i> on page 3219.
<code>p</code>	<b>in</b> Void pointer passed to the function pointed by <code>pfGetData</code> .

#### Return value

Y-size of the bitmap.

### 6.4.1.2.1.10 GUI\_BMP\_Serialize()

#### Description

The function creates a BMP file containing the complete content of the LCD. The BMP file is created using the color depth which is used in emWin at a maximum of 24 bpp. In case of using a color depth of less than 8bpp the color depth of the BMP file will be 8bpp.

The currently selected device is used for reading the pixel data. If a Memory Device is selected its content is written to the file.

This function does not support storing compressed BMP data.

#### Prototype

```
void GUI_BMP_Serialize(GUI_CALLBACK_VOID_U8_P * pfSerialize,
                      void * p);
```

#### Parameters

Parameter	Description
<code>pfSerialize</code>	Pointer to serialization function
<code>p</code>	Pointer to user defined data passed to serialization function

#### Example

The following example shows how to create a BMP file under windows.

```
static void _DrawSomething(void) {
    /* Draw something */
    GUI_DrawLine(10, 10, 100, 100);
}
static void _WriteByte2File(U8 Data, void * p) {
    U32 nWritten;
    WriteFile(*(HANDLE *)p, &Data, 1, &nWritten, NULL);
}
static void _ExportToFile(void) {
    HANDLE hFile = CreateFile("C:\\GUI_BMP_Serialize.bmp", GENERIC_WRITE, 0, 0,
                             CREATE_ALWAYS, FILE_ATTRIBUTE_NORMAL, 0);
    GUI_BMP_Serialize(_WriteByte2File, &hFile);
    CloseHandle(hFile);
}
void MainTask(void) {
    GUI_Init();
    _DrawSomething();
    _ExportToFile();
}
```

### 6.4.1.2.1.11 GUI\_BMP\_SerializeEx()

#### Description

The function creates a BMP file containing the given area. The BMP file is created using the color depth which is used in emWin at a maximum of 24 bpp. In case of using a color depth of less than 8bpp the color depth of the BMP file will be 8bpp. The currently selected device is used for reading the pixel data. If a Memory Device is selected its content is written to the file.

This function does not support storing compressed BMP data.

#### Prototype

```
void GUI_BMP_SerializeEx(GUI_CALLBACK_VOID_U8_P * pfSerialize,
                        int x0,
                        int y0,
                        int xSize,
                        int ySize,
                        void * p);
```

#### Parameters

Parameter	Description
<code>pfSerialize</code>	Pointer to user defined serialization function. See prototype below.
<code>x0</code>	Start position in X to create the BMP file.
<code>y0</code>	Start position in Y to create the BMP file.
<code>xSize</code>	Size in X.
<code>ySize</code>	Size in Y.
<code>p</code>	Pointer to user defined data passed to serialization function.

#### Prototype of GUI\_CALLBACK\_VOID\_U8\_P

```
void GUI_CALLBACK_VOID_U8_P(U8 Data, void * p);
```

#### Additional information

An example can be found in the description of `GUI_BMP_Serialize()`.

### 6.4.1.2.1.12 GUI\_BMP\_SerializeExBpp()

#### Description

The function creates a BMP file containing the given area using the specified color depth. In case of using a color depth of less than 8bpp the color depth of the BMP file will be 8bpp. The color depth should be a multiple of 8. In case of a system color depth of more than 8bpp the color depth needs to be 16bpp or more. The currently selected device is used for reading the pixel data. If a Memory Device is selected its content is written to the file. This function does not support storing compressed BMP data.

#### Prototype

```
void GUI_BMP_SerializeExBpp(GUI_CALLBACK_VOID_U8_P * pfSerialize,
                           int x0,
                           int y0,
                           int xSize,
                           int ySize,
                           void * p,
                           int BitsPerPixel);
```

#### Parameters

Parameter	Description
<code>pfSerialize</code>	Pointer to user defined serialization function. See prototype below.
<code>x0</code>	Start position in X to create the BMP file.
<code>y0</code>	Start position in Y to create the BMP file.
<code>xSize</code>	Size in X.
<code>ySize</code>	Size in Y.
<code>p</code>	Pointer to user defined data passed to serialization function.
<code>BitsPerPixel</code>	Color depth.

#### Prototype of GUI\_CALLBACK\_VOID\_U8\_P

```
void GUI_CALLBACK_VOID_U8_P(U8 Data, void * p);
```

#### Additional information

An example can be found in the description of `GUI_BMP_Serialize()` above.

## 6.4.1.2.2 Prototypes

### 6.4.1.2.2.1 GUI\_BMP\_GET\_DATA\_FUNC

#### Description

GetData function used for the BMP format, for more details see [GUI\\_GET\\_DATA\\_FUNC\\_I](#).

#### Type definition

```
typedef GUI_GET_DATA_FUNC_I GUI_BMP_GET_DATA_FUNC;
```

## 6.4.2 JPEG file support

JPEG (pronounced "jay-peg") is a standardized compression method for full-color and gray-scale images. JPEG is intended for compressing "real-world" scenes; line drawings, cartoons and other non-realistic images are not its strong suit. JPEG is lossy, meaning that the output image is not exactly identical to the input image. Hence you must not use JPEG if you have to have identical output bits. However, on typical photographic images, very good compression levels can be obtained with no visible change, and remarkably high compression levels are possible if you can tolerate a low-quality image.

### 6.4.2.1 Supported JPEG compression methods

This software implements JPEG baseline, extended-sequential and progressive compression processes. Provision is made for supporting all variants of these processes, although some uncommon parameter settings are not implemented yet. For legal reasons, code for the arithmetic-coding variants of JPEG is not distributed. It appears that the arithmetic coding option of the JPEG spec is covered by patents owned by IBM, AT&T, and Mitsubishi. Hence arithmetic coding cannot legally be used without obtaining one or more licenses. For this reason, support for arithmetic coding has not been included. (Since arithmetic coding provides only a marginal gain over the unpatented Huffman mode, it is unlikely that very many implementations will support it.)

### 6.4.2.2 Limitations

The JPEG file support does not contain provision for the hierarchical or lossless processes defined in the standard.

Furthermore, only JPEG files based on the yCbCr and gray scale color spaces are supported.

### 6.4.2.3 Converting a JPEG file to C source

Under some circumstances it can be useful to add a JPEG file as C file to the project. In this case the JPEG file first needs to be converted to a C file. This can be done using the tool `Bin2C.exe` shipped with emWin. It can be found in the `Tools` subfolder. It converts the given binary file (in this case the JPEG file) to a C file. The filename of the C file is the same as the binary file name with the file extension `.c`. The following steps will show how to embed a JPEG file using `Bin2C`:

- Start `Bin2C.exe` and select the JPEG file to be converted to a C file, for example 'Image.jpeg' and convert it to a C file.
- Add the C file to the project.

#### Example

The following example shows how to display the converted JPEG file:

```
#include "GUI.h"
#include "Image.c" /* Include the converted C file */
void MainTask(void) {
    GUI_Init();
    GUI_JPEG_Draw(acImage, sizeof(acImage), 0, 0);
    ...
}
```

### 6.4.2.4 Displaying JPEG files

The graphic library first decodes the graphic information. If the image has to be drawn the decoding process takes considerable time. If a JPEG file is used in a frequently called callback routine of the Window Manager, the decoding process can take a considerable amount of time. The calculation time can be reduced by the use of Memory Devices. The best way would be to draw the image first into a Memory Device. In this case the decompression would be executed only one time. For more information about Memory Devices, refer to chapter *Memory Devices* on page 2916.

### 6.4.2.5 Hardware support for decoding JPEG files

It is possible to use a hardware JPEG decoder of a MCU. For further information, please refer to *JPEG decoding* on page 180.

### 6.4.2.6 IDCT configuration

Through the configuration define `GUI_JPEG_CONFIG_IDCT`, it is possible to select one of the five available software algorithms that compute the Inverse Discrete Cosine Transformation (IDCT) during the decoding process of a JPEG image.

The configuration define can be redefined in the `GUI_Conf.h` header. Below is an example, the `I32_SCALAR` algorithm is selected as the default.

```
#define GUI_JPEG_CONFIG_IDCT          GUI_IDCT_I32_SCALAR
```

#### Available IDCT algorithms

Configuration options	Description
<code>GUI_IDCT_I16_SCALAR</code>	16-bit integer algorithm, scalar.
<code>GUI_IDCT_I16_NEON</code>	16-bit integer algorithm, in vectorized Neon.
<code>GUI_IDCT_I16_HELIUM</code>	16-bit integer algorithm, in vectorized Helium.
<code>GUI_IDCT_I32_SCALAR</code>	32-bit integer algorithm, scalar.
<code>GUI_IDCT_I32_HELIUM</code>	32-bit integer algorithm, in vectorized Helium.

#### Platform compatibility

The scalar algorithms (I16 and I32) can be used on all platforms.

The Helium algorithms are intended to be used with CPUs of the ARM v8.1-M architecture, e.g. Cortex-M85 and Corted-M55.

The Neon algorithms run on ARM's A-profile and R-profile processors, e.g. ARM Cortex-A9.

#### Notes on performance

- Given that the algorithm is supported, the Neon and Helium algorithms are faster than their counterpart scalar algorithms.
- The 16-bit IDCT is slightly less accurate than the corresponding 32-bit IDTC, but it is also slightly faster. The results on display are indistinguishable to the human eye.
- The chapter *Performance and Resource Usage* on page 3474 contains a table with detailed performance values of the JPEG decoder.

### 6.4.2.7 Memory usage

The JPEG decompression uses approximately 33 KB RAM for decompression independent of the image size and a size dependent amount of bytes. The RAM requirement can be calculated as follows:

```
Approx. RAM requirement = X-Size of image * 80 bytes + 33 KB
```

The X-size dependent amount depends on the compression type of the JPEG file. The following table shows some examples:

Compression	Size of image in pixels	RAM usage (KB)	RAM usage, size dependent (KB)
H1V1	160x120	45	12
H2V2	160x120	46	13
GRAY	160x120	38	4

The memory required for the decompression is allocated dynamically by the emWin memory management system. After drawing the JPEG image the complete RAM will be released.

### 6.4.2.8 Progressive JPEG files

Contrary to baseline and extended-sequential JPEG files progressive JPEGs consist of multiple scans. Each of these scans is based on the previous scan(s) and refines the appearance of the JPEG image. This requires scanning the whole file even if only one line needs to be decompressed.

The structure member `Progressive` of the structure `GUI_JPEG_INFO` indicates whether a JPEG image is progressive or not.

### 6.4.2.9 JPEG API

The table below lists the available JPEG file related routines in alphabetical order. Detailed function descriptions follow:

#### Functions

Routine	Description
<code>GUI_JPEG_Draw()</code>	Draws a JPEG file which has been loaded into memory.
<code>GUI_JPEG_DrawEx()</code>	Draws a JPEG file which does not need to be loaded into memory.
<code>GUI_JPEG_DrawScaled()</code>	Draws a JPEG file with scaling which has been loaded into memory.
<code>GUI_JPEG_DrawScaledEx()</code>	Draws a JPEG file with scaling which does not need to be loaded into memory.
<code>GUI_JPEG_GetInfo()</code>	Fills a <code>GUI_JPEG_INFO</code> structure with information about a JPEG file, which has been loaded into memory.
<code>GUI_JPEG_GetInfoEx()</code>	Fills a <code>GUI_JPEG_INFO</code> structure with information about a JPEG file, which does not have to be loaded into memory.
<code>GUI_JPEG_SetpWritePixels()</code>	Sets function pointer to copy the decoded JPEG to the display.

#### Data structures

Structure	Description
<code>GUI_JPEG_INFO</code>	Information about a JPEG image.

#### Prototypes

Structure	Description
<code>GUI_JPEG_GET_DATA_FUNC</code>	GetData function used for the JPEG format, for more details see <code>GUI_GET_DATA_FUNC_I</code> .
<code>GUI_JPEG_WRITECLIPPEDPIXELS_FUNC</code>	Function that retrieves the decoded result of a JPEG and writes the pixels to the display.



## 6.4.2.9.1 Functions

### 6.4.2.9.1.1 GUI\_JPEG\_Draw()

#### Description

Draws a JPEG file, which has been loaded into memory, at a specified position in the current window.

#### Prototype

```
int GUI_JPEG_Draw(const void * pFileData,
                  int      DataSize,
                  int      x0,
                  int      y0);
```

#### Parameters

Parameter	Description
<code>pFileData</code>	Pointer to the start of the memory area in which the JPEG file resides.
<code>DataSize</code>	Number of bytes of the JPEG file.
<code>x0</code>	X-position of the upper left corner of the bitmap in the display.
<code>y0</code>	Y-position of the upper left corner of the bitmap in the display.

#### Return value

= 0        on success  
 ≠ 0        if the function fails. (The current implementation always returns 0).

#### Additional information

The `Sample` folder contains the example `2DGL_DrawJPG.c` which shows how to use the function.

### 6.4.2.9.1.2 GUI\_JPEG\_DrawEx()

#### Description

Draws a JPEG file, which does not have to be loaded into memory, at a specified position in the current window.

#### Prototype

```
int GUI_JPEG_DrawEx(GUI_JPEG_GET_DATA_FUNC * pfGetData,
                   void * p,
                   int x0,
                   int y0);
```

#### Parameters

Parameter	Description
<code>pfGetData</code>	<b>in</b> Function pointer to a GetData function. For more details, please refer to the chapter <i>FileAccess</i> on page 3219.
<code>p</code>	<b>in</b> Void pointer passed to the function pointed by <code>pfGetData</code> .
<code>x0</code>	X-position of the upper left corner of the bitmap in the display.
<code>y0</code>	Y-position of the upper left corner of the bitmap in the display.

#### Return value

= 0        on success.  
 ≠ 0        if the function fails. (The current implementation always returns 0.)

#### Additional information

This function is used for drawing jpegs if not enough RAM is available to load the whole file into memory. The JPEG library then calls the function pointed by the parameter `pfGetData` to read the data.

The GetData function should return the number of available bytes. This may be less or equal the number of requested bytes. The function needs at least to return 1 new byte. The `Sample` folder contains the example `2DGL_DrawJPGScaled.c` which shows how to use a GetData function.

### 6.4.2.9.1.3 GUI\_JPEG\_DrawScaled()

#### Description

Draws a JPEG file, which has been loaded into memory, at a specified position in the current window using scaling.

#### Prototype

```
int GUI_JPEG_DrawScaled(const void * pFileData,
                       int      DataSize,
                       int      x0,
                       int      y0,
                       int      Num,
                       int      Denom);
```

#### Parameters

Parameter	Description
<code>pFileData</code>	Pointer to the start of the memory area in which the jpeg file resides.
<code>DataSize</code>	Number of bytes of the JPEG file.
<code>x0</code>	X-position of the upper left corner of the bitmap in the display.
<code>y0</code>	Y-position of the upper left corner of the bitmap in the display.
<code>Num</code>	Numerator to be used for scaling.
<code>Denom</code>	Denominator used for scaling.

#### Return value

= 0      on success.

≠ 0      if the function fails. (The current implementation always returns 0).

#### Additional information

The function scales the image by building a fraction with the given numerator and denominator. If for example an image should be shrunk to 2/3 of size the parameter `Num` should be 2 and `Denom` should be 3.

The `Sample` folder contains the example `2DGL_DrawJPGScaled.c` which shows how to draw scaled JPEGs.

### 6.4.2.9.1.4 GUI\_JPEG\_DrawScaledEx()

#### Description

Draws a JPEG file, which does not have to be loaded into memory, at a specified position in the current window using scaling.

#### Prototype

```
int GUI_JPEG_DrawScaledEx(GUI_JPEG_GET_DATA_FUNC * pfGetData,
                          void * p,
                          int x0,
                          int y0,
                          int Num,
                          int Denom);
```

#### Parameters

Parameter	Description
<code>pfGetData</code>	<b>in</b> Function pointer to a GetData function. For more details, please refer to the chapter <i>FileAccess</i> on page 3219.
<code>p</code>	<b>in</b> Void pointer passed to the function pointed by <code>pfGetData</code> .
<code>x0</code>	X-position of the upper left corner of the bitmap in the display.
<code>y0</code>	Y-position of the upper left corner of the bitmap in the display.
<code>Num</code>	Numerator to be used for scaling.
<code>Denom</code>	Denominator used for scaling.

#### Return value

= 0      on success.  
 ≠ 0      if the function fails. (The current implementation always returns 0).

#### Additional information

The function scales the image by building a fraction with the given numerator and denominator. If for example an image should be shrunk to 2/3 of size the parameter `Num` should be 2 and `Denom` should be 3.

For more details, refer to `GUI_JPEG_DrawEx()`. The `Sample` folder contains the example `2DGL_DrawJPGScaled.c` which shows how to use the function.

### 6.4.2.9.1.5 GUI\_JPEG\_GetInfo()

#### Description

Fills a `GUI_JPEG_INFO` structure with information about a JPEG file, which has been loaded into memory.

#### Prototype

```
int GUI_JPEG_GetInfo(const void * pFileData,  
                    int      DataSize,  
                    GUI_JPEG_INFO * pInfo);
```

#### Parameters

Parameter	Description
<code>pFileData</code>	Pointer to the start of the memory area in which the JPEG file resides.
<code>DataSize</code>	Number of bytes of the JPEG file.
<code>pInfo</code>	Pointer to a <code>GUI_JPEG_INFO</code> structure to be filled by the function.

#### Return value

= 0        on success.  
≠ 0        if the function fails.

#### Additional information

The Sample folder contains the example `2DGL_DrawJPG.c` which shows how to use the function.

### 6.4.2.9.1.6 GUI\_JPEG\_GetInfoEx()

#### Description

Fills a `GUI_JPEG_INFO` structure with information about a JPEG file, which does not have to be loaded into memory.

#### Prototype

```
int GUI_JPEG_GetInfoEx(GUI_JPEG_GET_DATA_FUNC * pfGetData,
                      void * p,
                      GUI_JPEG_INFO * pInfo);
```

#### Parameters

Parameter	Description
<code>pfGetData</code>	<b>in</b> Function pointer to a <code>GetData</code> function. For more details, please refer to the chapter <i>FileAccess</i> on page 3219.
<code>p</code>	<b>in</b> Void pointer passed to the function pointed by <code>pfGetData</code> .
<code>pInfo</code>	<b>out</b> Pointer to a <code>GUI_JPEG_INFO</code> structure to be filled by the function.

#### Return value

= 0        on success.  
 ≠ 0        if the function fails.

#### Additional information

For more details about the function and the parameters `pfGetData` and `p`, refer to `GUI_JPEG_GetInfo()` and `GUI_JPEG_DrawEx()`. The `Sample` folder contains the example `2DGL_DrawJPGScaled.c` which shows how to use the function.

### 6.4.2.9.1.7 GUI\_JPEG\_SetpfWritePixels()

#### Description

Sets function pointer to copy the decoded JPEG to the display. This function can be utilized to measure performance of JPEG decoder.

#### Prototype

```
GUI_JPEG_WRITECLIPPEDPIXELS_FUNC *GUI_JPEG_SetpfWritePixels  
    (GUI_JPEG_WRITECLIPPEDPIXELS_FUNC * pFunc);
```

#### Parameters

Parameter	Description
<a href="#">pFunc</a>	Pointer to a function of the type GUI_JPEG_WRITECLIPPED-PIXELS_FUNC.

#### Return value

Pointer to the previously set function.

## 6.4.2.9.2 Data structures

### 6.4.2.9.2.1 GUI\_JPEG\_INFO

#### Description

Information about a JPEG image.

#### Type definition

```
typedef struct {  
    int XSize;  
    int YSize;  
    int Progressive;  
} GUI_JPEG_INFO;
```

#### Structure members

Member	Description
<a href="#">XSize</a>	X-size of the image.
<a href="#">YSize</a>	Y-size of the image.
<a href="#">Progressive</a>	Indicates if JPEG is progressive or not

#### See also

- [GUI\\_JPEG\\_GetInfo\(\)](#)
- [GUI\\_JPEG\\_GetInfoEx\(\)](#)



### 6.4.2.9.3 Prototypes

#### 6.4.2.9.3.1 GUI\_JPEG\_GET\_DATA\_FUNC

##### Description

GetData function used for the JPEG format, for more details see [GUI\\_GET\\_DATA\\_FUNC\\_I](#).

##### Type definition

```
typedef GUI_GET_DATA_FUNC_I GUI_JPEG_GET_DATA_FUNC;
```

### 6.4.2.9.3.2 GUI\_JPEG\_WRITECLIPPEDPIXELS\_FUNC

#### Description

Function that retrieves the decoded result of a JPEG and writes the pixels to the display.

#### Type definition

```
typedef void (GUI_JPEG_WRITECLIPPEDPIXELS_FUNC)
(
    int          x0,
    int          y0,
    int          xSize,
    LCD_COLOR    * pColor,
    GUI_JPEG_DCONTEXT * pContext,
    const LCD_API_COLOR_CONV * pColorConvAPI);
```

#### Parameters

Parameter	Description
<code>x0</code>	X drawing position of the JPEG.
<code>y0</code>	Y drawing position of the JPEG.
<code>xSize</code>	Width of one line.
<code>pColor</code>	<b>in</b> Pointer to decoded JPEG data.
<code>pContext</code>	<b>in</b> Pointer to JPEG context.
<code>pColorConvAPI</code>	<b>in</b> Pointer to selected color conversion API.

## 6.4.3 GIF file support

The GIF file format (Graphic Interchange Format) has been developed by the CompuServe Information Service in the 1980s. It has been designed to transmit images across data networks.

The GIF standard supports interlacing, transparency, application defined data, animations and rendering of raw text. Unsupported data like raw text or application specific data will be ignored by emWin.

GIF files use the LZW (Lempel-Zif-Welch) file compression method for compressing the image data. This compression method works without losing data. The output image is exactly identical to the input image.

### 6.4.3.1 Converting a GIF file to C source

Under some circumstances it can be useful to add a GIF file as C file to the project. This can be done by exactly the same way as described before under *JPEG file support* on page 462.

### 6.4.3.2 Displaying GIF files

The graphic library first decodes the graphic information. If the image has to be drawn the decoding process takes considerable time. If a GIF file is used in a frequently called callback routine of the Window Manager, the decoding process can take a considerable amount of time. The calculation time can be reduced by the use of Memory Devices. The best way would be to draw the image first into a Memory Device. In this case the decompression would be executed only one time. For more information about Memory Devices, refer to the chapter *Memory Devices* on page 2916.

### 6.4.3.3 Memory usage

The GIF decompression routine of emWin needs about 16Kbytes of dynamically allocated RAM for decompression. After drawing an image the RAM which was used for decompression will be released.

### 6.4.3.4 GIF API

The table below lists the available GIF file related routines in alphabetical order. Detailed function descriptions follow:

#### Functions

Routine	Description
<a href="#">GUI_GIF_Draw()</a>	Draws the first image of a GIF file which has been loaded into memory.
<a href="#">GUI_GIF_DrawEx()</a>	Draws the first image of a GIF file which does not need to be loaded into memory.
<a href="#">GUI_GIF_DrawSub()</a>	Draws the given sub image of a GIF file which has been loaded into memory.
<a href="#">GUI_GIF_DrawSubEx()</a>	Draws the given sub image of a GIF file which does not need to be loaded into memory.
<a href="#">GUI_GIF_DrawSubScaled()</a>	Draws the given sub image of a GIF file with scaling which has been loaded into memory.
<a href="#">GUI_GIF_DrawSubScaledEx()</a>	Draws the given sub image of a GIF file with scaling which does not need to be loaded into memory.
<a href="#">GUI_GIF_GetComment()</a>	Returns the given comment of a GIF file which has been loaded into memory.

Routine	Description
<a href="#">GUI_GIF_GetCommentEx()</a>	Returns the given comment of a GIF file which does not need to be loaded into memory.
<a href="#">GUI_GIF_GetImageInfo()</a>	Returns information about the given sub image of a GIF file which has been loaded into memory.
<a href="#">GUI_GIF_GetImageInfoEx()</a>	Returns information about the given sub image of a GIF file which does not need to be loaded into memory.
<a href="#">GUI_GIF_GetInfo()</a>	Returns information about a GIF file which has been loaded into memory.
<a href="#">GUI_GIF_GetInfoEx()</a>	Returns information about a GIF file which does not need to be loaded into memory.
<a href="#">GUI_GIF_GetXSize()</a>	Returns the X-size of a bitmap loaded into memory.
<a href="#">GUI_GIF_GetXSizeEx()</a>	Returns the X-size of a bitmap which does not need to be loaded into memory.
<a href="#">GUI_GIF_GetYSize()</a>	Returns the Y-size of a bitmap loaded into memory.
<a href="#">GUI_GIF_GetYSizeEx()</a>	Returns the Y-size of a bitmap which does not need to be loaded into memory.

### Data structures

Structure	Description
<a href="#">GUI_GIF_IMAGE_INFO</a>	Information about a sub-image in a GIF file.
<a href="#">GUI_GIF_INFO</a>	Information about a sub-image in a GIF file.

### Prototypes

Structure	Description
<a href="#">GUI_GIF_GET_DATA_FUNC</a>	GetData function used for the GIF format, for more details see <a href="#">GUI_GET_DATA_FUNC_I</a> .

### 6.4.3.4.1 Functions

#### 6.4.3.4.1.1 GUI\_GIF\_Draw()

##### Description

Draws the first image of a gif file, which has been loaded into memory, at a specified position in the current window.

##### Prototype

```
int GUI_GIF_Draw(const void * pGIF,
                 U32      NumBytes,
                 int      x0,
                 int      y0);
```

##### Parameters

Parameter	Description
<code>pGIF</code>	Pointer to the start of the memory area in which the gif file resides.
<code>NumBytes</code>	Number of bytes of the gif file.
<code>x0</code>	X-position of the upper left corner of the bitmap in the display.
<code>y0</code>	Y-position of the upper left corner of the bitmap in the display.

##### Return value

= 0      on success  
 ≠ 0      on error.

##### Additional information

If the file contains more than one image, the function shows only the first image of the file. Transparency and interlaced images are supported.

### 6.4.3.4.1.2 GUI\_GIF\_DrawEx()

#### Description

Draws a gif file, which does not have to be loaded into memory, at a specified position in the current window.

#### Prototype

```
int GUI_GIF_DrawEx(GUI_GIF_GET_DATA_FUNC * pfGetData,
                  void * p,
                  int x0,
                  int y0);
```

#### Parameters

Parameter	Description
<code>pfGetData</code>	<b>in</b> Function pointer to a GetData function. For more details, please refer to the chapter <i>FileAccess</i> on page 3219.
<code>p</code>	<b>in</b> Void pointer passed to the function pointed by <code>pfGetData</code> .
<code>x0</code>	X-position of the upper left corner of the bitmap in the display.
<code>y0</code>	Y-position of the upper left corner of the bitmap in the display.

#### Return value

= 0      on success  
 ≠ 0     on error.

#### Additional information

This function is used for drawing gif files if not enough RAM is available to load the whole file into memory. The library calls the function pointed by the parameter `pfGetData` to read the data. The GetData function should return the number of available bytes. This could be less or equal the number of requested bytes. The function needs at least to return 1 new byte.

### 6.4.3.4.1.3 GUI\_GIF\_DrawSub()

#### Description

Draws the given sub image of a gif file, which has been loaded into memory, at a specified position in the current window.

#### Prototype

```
int GUI_GIF_DrawSub(const void * pGIF,
                   U32    NumBytes,
                   int    x0,
                   int    y0,
                   int    Index);
```

#### Parameters

Parameter	Description
<code>pGIF</code>	Pointer to the start of the memory area in which the gif file resides.
<code>NumBytes</code>	Number of bytes of the gif file.
<code>x0</code>	X-position of the upper left corner of the bitmap in the display.
<code>y0</code>	Y-position of the upper left corner of the bitmap in the display.
<code>Index</code>	Zero-based index of sub image to be shown.

#### Return value

= 0      on success  
 ≠ 0      on error.

#### Additional information

The function manages the background pixels between the current and the previous image. If for example sub image #3 should be drawn at offset x20/y20 with a size of w10/h10 and the previous sub image was shown at x15/y15 with a size of w20/h20 and the background needs to be redrawn, the function fills the pixels between the images with the background color. The file `2DGL_DrawGIF.c` of the Sample folder shows how to use the function.

### 6.4.3.4.1.4 GUI\_GIF\_DrawSubEx()

#### Description

Draws the given sub image of a gif file, which does not have to be loaded into memory, at a specified position in the current window.

#### Prototype

```
int GUI_GIF_DrawSubEx(GUI_GIF_GET_DATA_FUNC * pfGetData,
                    void * p,
                    int x0,
                    int y0,
                    int Index);
```

#### Parameters

Parameter	Description
<a href="#">pfGetData</a>	<b>in</b> Function pointer to a GetData function. For more details, please refer to the chapter <i>FileAccess</i> on page 3219.
<a href="#">p</a>	<b>in</b> Void pointer passed to the function pointed by <a href="#">pfGetData</a> .
<a href="#">x0</a>	X-position of the upper left corner of the bitmap in the display.
<a href="#">y0</a>	Y-position of the upper left corner of the bitmap in the display.
<a href="#">Index</a>	Zero-based index of sub image to be shown.

#### Return value

= 0      on success  
 ≠ 0      on error.

#### Additional information

This function is used for drawing gif images if not enough RAM is available to load the whole file into memory. The GUI library then calls the function pointed by the parameter [pfGetData](#) to read the data.

For more details, refer to the `GUI_GIF_DrawEx()`.



### 6.4.3.4.1.5 GUI\_GIF\_DrawSubScaled()

#### Description

Draws the given sub image of a gif file, which has been loaded into memory, at a specified position in the current window using scaling.

#### Prototype

```
int GUI_GIF_DrawSubScaled(const void * pGIF,
                          U32      NumBytes,
                          int      x0,
                          int      y0,
                          int      Index,
                          int      Num,
                          int      Denom);
```

#### Parameters

Parameter	Description
<code>pGIF</code>	Pointer to the start of the memory area in which the gif file resides.
<code>NumBytes</code>	Number of bytes of the gif file.
<code>x0</code>	X-position of the upper left corner of the bitmap in the display.
<code>y0</code>	Y-position of the upper left corner of the bitmap in the display.
<code>Index</code>	Zero-based index of sub image to be shown.
<code>Num</code>	Numerator to be used for scaling.
<code>Denom</code>	Denominator used for scaling.

#### Return value

= 0      on success  
 ≠ 0      on error.

#### Additional information

The function scales the image by building a fraction with the given numerator and denominator. If for example an image should be shrunk to 2/3 of size the parameter `Num` should be 2 and `Denom` should be 3.

### 6.4.3.4.1.6 GUI\_GIF\_DrawSubScaledEx()

#### Description

Draws the given sub image of a gif file, which does not have to be loaded into memory, at a specified position in the current window using scaling.

#### Prototype

```
int GUI_GIF_DrawSubScaledEx(GUI_GIF_GET_DATA_FUNC * pfGetData,
                           void * p,
                           int x0,
                           int y0,
                           int Index,
                           int Num,
                           int Denom);
```

#### Parameters

Parameter	Description
<code>pfGetData</code>	<b>in</b> Function pointer to a GetData function. For more details, please refer to the chapter <i>FileAccess</i> on page 3219.
<code>p</code>	<b>in</b> Void pointer passed to the function pointed by <code>pfGetData</code> .
<code>x0</code>	X-position of the upper left corner of the bitmap in the display.
<code>y0</code>	Y-position of the upper left corner of the bitmap in the display.
<code>Index</code>	Zero-based index of sub image to be shown.
<code>Num</code>	Numerator to be used for scaling.
<code>Denom</code>	Denominator used for scaling.

#### Return value

= 0      on success  
 ≠ 0      on error.

#### Additional information

The function scales the image by building a fraction with the given numerator and denominator. If for example an image should be shrunk to 2/3 of size the parameter `Num` should be 2 and `Denom` should be 3.

### 6.4.3.4.1.7 GUI\_GIF\_GetComment()

#### Description

Returns the given comment from a GIF image, which has been loaded into memory.

#### Prototype

```
int GUI_GIF_GetComment(const void * pGIF,
                      U32      NumBytes,
                      U8      * pBuffer,
                      int      MaxSize,
                      int      Index);
```

#### Parameters

Parameter	Description
<code>pGIF</code>	Pointer to the start of the memory area in which the gif file resides.
<code>NumBytes</code>	Number of bytes of the gif file.
<code>pBuffer</code>	Pointer to a buffer to be filled with the comment.
<code>MaxSize</code>	Size of the buffer.
<code>Index</code>	Zero based index of comment to be returned.

#### Return value

= 0      on success  
 ≠ 0      on error.

#### Additional information

A GIF file can contain 1 or more comments. The function copies the comment into the given buffer. If the comment is larger than the given buffer only the bytes which fit into the buffer will be copied. The file `2DGL_DrawGIF.c` of the Sample folder shows how to use the function.

### 6.4.3.4.1.8 GUI\_GIF\_GetCommentEx()

#### Description

Returns the given comment from a GIF image, which does not have to be loaded into memory.

#### Prototype

```
int GUI_GIF_GetCommentEx(GUI_GIF_GET_DATA_FUNC * pfGetData,
                        void * p,
                        U8 * pBuffer,
                        int MaxSize,
                        int Index);
```

#### Parameters

Parameter	Description
<code>pfGetData</code>	<b>in</b> Function pointer to a GetData function. For more details, please refer to the chapter <i>FileAccess</i> on page 3219.
<code>p</code>	<b>in</b> Void pointer passed to the function pointed by <code>pfGetData</code> .
<code>pBuffer</code>	<b>out</b> Pointer to a buffer to be filled with the comment.
<code>MaxSize</code>	Size of the buffer.
<code>Index</code>	Zero based index of comment to be returned.

#### Return value

= 0      on success  
 ≠ 0      on error.

#### Additional information

For details, refer to `GUI_GIF_GetComment()`.

### 6.4.3.4.1.9 GUI\_GIF\_GetImageInfo()

#### Description

Returns information about the given sub image of a GIF file, which has been loaded into memory.

#### Prototype

```
int GUI_GIF_GetImageInfo(const void          * pGIF,
                        U32                NumBytes,
                        GUI_GIF_IMAGE_INFO * pInfo,
                        int                  Index);
```

#### Parameters

Parameter	Description
<code>pGIF</code>	Pointer to the start of the memory area in which the gif file resides.
<code>NumBytes</code>	Number of bytes of the gif file.
<code>pInfo</code>	Pointer to a <code>GUI_GIF_IMAGE_INFO</code> structure which will be filled by the function.
<code>Index</code>	Zero based index of sub image.

#### Return value

= 0      on success  
 ≠ 0      on error.

#### Additional information

If an image needs be shown as a movie this function should be used to get the time the sub image should be visible and the next sub image should be shown. If the delay member is 0 the image should be visible for 1/10 second.

### 6.4.3.4.1.10 GUI\_GIF\_GetImageInfoEx()

#### Description

Returns information about the given sub image of a GIF file, which does not need to be loaded into memory.

#### Prototype

```
int GUI_GIF_GetImageInfoEx(GUI_GIF_GET_DATA_FUNC * pfGetData,
                           void * p,
                           GUI_GIF_IMAGE_INFO * pInfo,
                           int Index);
```

#### Parameters

Parameter	Description
<code>pfGetData</code>	<b>in</b> Function pointer to a GetData function. For more details, please refer to the chapter <i>FileAccess</i> on page 3219.
<code>p</code>	<b>in</b> Void pointer passed to the function pointed by <code>pfGetData</code> .
<code>pInfo</code>	<b>out</b> Pointer to a GUI_GIF_IMAGE_INFO structure which will be filled by the function.
<code>Index</code>	Zero based index of sub image.

#### Return value

= 0      on success  
 ≠ 0     on error.

#### Additional information

For more details, refer to `GUI_GIF_GetImageInfo()`.

### 6.4.3.4.1.11 GUI\_GIF\_GetInfo()

#### Description

Returns an information structure with information about the size and the number of sub images within the given GIF file, which has been loaded into memory.

#### Prototype

```
int GUI_GIF_GetInfo(const void * pGIF,  
                   U32 NumBytes,  
                   GUI_GIF_INFO * pInfo);
```

#### Parameters

Parameter	Description
<code>pGIF</code>	Pointer to the start of the memory area in which the gif file resides.
<code>NumBytes</code>	Number of bytes of the gif file.
<code>pInfo</code>	Pointer to a <code>GUI_GIF_INFO</code> structure which will be filled by this function.

#### Return value

= 0 on success  
≠ 0 on error.

### 6.4.3.4.1.12 GUI\_GIF\_GetInfoEx()

#### Description

Returns an information structure with information about the size and the number of sub images within the given GIF file, which does not need to be loaded into memory.

#### Prototype

```
int GUI_GIF_GetInfoEx(GUI_GIF_GET_DATA_FUNC * pfGetData,
                    void * p,
                    GUI_GIF_INFO * pInfo);
```

#### Parameters

Parameter	Description
<code>pfGetData</code>	<b>in</b> Function pointer to a GetData function. For more details, please refer to the chapter <i>FileAccess</i> on page 3219.
<code>p</code>	<b>in</b> Void pointer passed to the function pointed by <code>pfGetData</code> .
<code>pInfo</code>	Pointer to a <code>GUI_GIF_INFO</code> structure which will be filled by this function.

#### Return value

= 0      on success  
 ≠ 0     on error.



### 6.4.3.4.1.13 GUI\_GIF\_GetXSize()

#### Description

Returns the X-size of a specified GIF image, which has been loaded into memory.

#### Prototype

```
int GUI_GIF_GetXSize(const void * pGIF);
```

#### Parameters

Parameter	Description
<code>pGIF</code>	Pointer to the start of the memory area in which the gif file resides.

#### Return value

X-size of the GIF image.

#### 6.4.3.4.1.14 GUI\_GIF\_GetXSizeEx()

##### Description

Returns the X-size of a specified GIF image, which does not need to be loaded into memory.

##### Prototype

```
int GUI_GIF_GetXSizeEx(GUI_GIF_GET_DATA_FUNC * pfGetData,  
                      void * p);
```

##### Parameters

Parameter	Description
<code>pfGetData</code>	<b>in</b> Function pointer to a GetData function. For more details, please refer to the chapter <i>FileAccess</i> on page 3219.
<code>p</code>	<b>in</b> Void pointer passed to the function pointed by <code>pfGetData</code> .

##### Return value

X-size of the GIF image.

### 6.4.3.4.1.15 GUI\_GIF\_GetYSize()

#### Description

Returns the Y-size of a specified GIF image, which has been loaded into memory.

#### Prototype

```
int GUI_GIF_GetYSize(const void * pGIF);
```

#### Parameters

Parameter	Description
<code>pGIF</code>	Pointer to the start of the memory area in which the bmp file resides.

#### Return value

Y-size of the GIF image.

### 6.4.3.4.1.16 GUI\_GIF\_GetYSizeEx()

#### Description

Returns the Y-size of a specified GIF image, which does not need to be loaded into memory.

#### Prototype

```
int GUI_GIF_GetYSizeEx(GUI_GIF_GET_DATA_FUNC * pfGetData,  
                      void * p);
```

#### Parameters

Parameter	Description
<code>pfGetData</code>	<b>in</b> Function pointer to a GetData function. For more details, please refer to the chapter <i>FileAccess</i> on page 3219.
<code>p</code>	<b>in</b> Void pointer passed to the function pointed by <code>pfGetData</code> .

#### Return value

Y-size of the GIF image.

## 6.4.3.4.2 Data structures

### 6.4.3.4.2.1 GUI\_GIF\_IMAGE\_INFO

#### Description

Information about a sub-image in a GIF file.

#### Type definition

```
typedef struct {
    int  xPos;
    int  yPos;
    int  xSize;
    int  ySize;
    int  Delay;
} GUI_GIF_IMAGE_INFO;
```

#### Structure members

Member	Description
<code>xPos</code>	X-position of the last drawn image.
<code>yPos</code>	Y-position of the last drawn image.
<code>xSize</code>	X-size of the last drawn image.
<code>ySize</code>	Y-size of the last drawn image.
<code>Delay</code>	Time in 1/100 seconds the image should be shown in a movie.

#### See also

- `GUI_GIF_GetImageInfo()`
- `GUI_GIF_GetImageInfoEx()`

### 6.4.3.4.2.2 GUI\_GIF\_INFO

#### Description

Information about a sub-image in a GIF file.

#### Type definition

```
typedef struct {  
    int  xSize;  
    int  ySize;  
    int  NumImages;  
} GUI_GIF_INFO;
```

#### Structure members

Member	Description
<a href="#">xSize</a>	Pixel size in X of the image.
<a href="#">ySize</a>	Pixel size in Y of the image.
<a href="#">NumImages</a>	Number of sub-images in the file.

#### See also

- [GUI\\_GIF\\_GetInfo\(\)](#)
- [GUI\\_GIF\\_GetInfoEx\(\)](#)

### 6.4.3.4.3 Prototypes

#### 6.4.3.4.3.1 GUI\_GIF\_GET\_DATA\_FUNC

##### Description

GetData function used for the GIF format, for more details see [GUI\\_GET\\_DATA\\_FUNC\\_I](#).

##### Type definition

```
typedef GUI_GET_DATA_FUNC_I GUI_GIF_GET_DATA_FUNC;
```

## 6.4.4 PNG file support

The PNG (Portable Network Graphics) format is an image format which offers lossless data compression and alpha blending by using a non-patented data compression method. Version 1.0 of the PNG specification has been released in 1996. Since the end of 2003 PNG is an international standard (ISO/IEC 15948). PNG support for emWin can be achieved by using the 'libpng' library from Glenn Randers-Pehrson, Guy Eric Schalnat and Andreas Dilger. An adapted version of this library ready to use with emWin is available [on our website](#). That library can be added to emWin in order to use the PNG API as explained later in this chapter.

### Licensing

The use of 'libpng' library is subject to a BSD style license and copyright notice in the file `GUI\PNG\png.h` of the downloadable library. The original version of the library is available for free under [www.libpng.org](http://www.libpng.org).

### 6.4.4.1 Converting a PNG file to C source

Under some circumstances it can be useful to add a PNG file as C file to the project. This can be done by exactly the same way as described before under *JPEG file support* on page 462. Further the Bitmap Converter is able to load PNG files and can convert them into C bitmap files.

### 6.4.4.2 Displaying PNG files

The graphic library first decodes the graphic information. If the image has to be drawn the decoding process takes considerable time. If a PNG file is used in a frequently called callback routine of the Window Manager, the decoding process can take a considerable amount of time. The calculation time can be reduced by the use of Memory Devices. The best way would be to draw the image first into a Memory Device. In this case the decompression would be executed only one time. For more information about Memory Devices, refer to the chapter *Memory Devices* on page 2916.

### 6.4.4.3 Memory usage

The PNG decompression uses approximately 21 KB of RAM for decompression independent of the image size and a size dependent amount of bytes. The RAM requirement can be calculated as follows:  $\text{Approx. RAM requirement} = (\text{xSize} + 1) * \text{ySize} * 4 + 54 \text{ KB}$

### 6.4.4.4 PNG API

The table below lists the available PNG file related routines in alphabetical order. Detailed function descriptions follow:

#### Functions

Routine	Description
<code>GUI_PNG_Draw()</code>	Draws the PNG file which has been loaded into memory.
<code>GUI_PNG_DrawEx()</code>	Draws the PNG file which does not need to be loaded into memory.
<code>GUI_PNG_GetXSize()</code>	Returns the X-size of a bitmap loaded into memory.
<code>GUI_PNG_GetXSizeEx()</code>	Returns the X-size of a bitmap which does not need to be loaded into memory.
<code>GUI_PNG_GetYSize()</code>	Returns the Y-size of a bitmap loaded into memory.
<code>GUI_PNG_GetYSizeEx()</code>	Returns the Y-size of a bitmap which does not need to be loaded into memory.



### 6.4.4.4.1 Functions

#### 6.4.4.4.1.1 GUI\_PNG\_Draw()

##### Description

Draws a png file, which has been loaded into memory, at a specified position in the current window.

##### Prototype

```
int GUI_PNG_Draw(const void * pFileData,
                int      FileSize,
                int      x0,
                int      y0);
```

##### Parameters

Parameter	Description
<code>pFileData</code>	Pointer to the start of the memory area in which the png file resides.
<code>FileSize</code>	Number of bytes of the png file.
<code>x0</code>	X-position of the upper left corner of the bitmap in the display.
<code>y0</code>	Y-position of the upper left corner of the bitmap in the display.

##### Return value

= 0      on success.  
 ≠ 0     if the function fails. (The current implementation always returns 0).

##### Additional information

The Sample folder contains the example `2DGL_DrawPNG.c` which shows how to use the function.

#### **6.4.4.4.1.2 GUI\_PNG\_DrawEx**

### 6.4.4.4.1.3 GUI\_PNG\_GetXSize()

#### Description

Returns the X-size of a specified PNG image, which has been loaded into memory.

#### Prototype

```
int GUI_PNG_GetXSize(const void * pFileData,  
                    int      FileSize);
```

#### Parameters

Parameter	Description
<code>pFileData</code>	Pointer to the start of the memory area in which the png file resides.
<code>FileSize</code>	Size of the file in bytes.

#### Return value

X-size of the PNG image.

#### **6.4.4.4.1.4 GUI\_PNG\_GetXSizeEx**

#### 6.4.4.4.1.5 GUI\_PNG\_GetYSize()

##### Description

Returns the Y-size of a specified PNG image, which has been loaded into memory.

##### Prototype

```
int GUI_PNG_GetYSize(const void * pFileData,  
                    int      FileSize);
```

##### Parameters

Parameter	Description
<code>pFileData</code>	Pointer to the start of the memory area in which the png file resides.
<code>FileSize</code>	Size of the file in bytes.

##### Return value

Y-size of the PNG image.

#### **6.4.4.4.1.6 GUI\_PNG\_GetYSizeEx**

## 6.4.4.4.2 Prototypes

### 6.4.4.4.2.1 GUI\_PNG\_GET\_DATA\_FUNC

#### Description

GetData function used for the PNG format, for more details see [GUI\\_GET\\_DATA\\_FUNC\\_II](#).

#### Type definition

```
typedef GUI_GET_DATA_FUNC_II GUI_PNG_GET_DATA_FUNC;
```

## 6.5 Displaying Scalable Vector Graphics (SVG) files

Scalable Vector Graphics (SVG) is a vector-based image format written in XML. The main advantage of SVGs over raster image formats (such as BMP, PNG, JPEG or GIF) is that they can be scaled to any size without losing quality.

SVG is an open standard developed by the World Wide Web Consortium (W3C) and is supported by most web browsers and desktop graphics software.

To render SVGs in emWin, one of the below 2D hardware vector graphic APIs has to be bound to emWin. The advantage is a huge performance boost through the use of a GPU.

The following 2D vector APIs are supported:

- Khronos OpenVG 1.1
- Vivante VGLite 2.0
- ThinkSilicon NemaVG 1.1.5 - 1.1.7
- Mikko Mononen's NanoVG





## 6.5.1 Supported features

emWin supports a subset of the SVG 1.1 specification. Below is a list of currently supported features.

- Stroking and filling of basic shapes (circles, ellipses, lines, polylines, polygons and rectangles)
- Stroking and filling of paths and groups
- Stroking and filling of gradients (linear and radial)
- Line dashing, line ends and line joins
- Images (PNG, JPEG, BMP, GIF), Base64 or ASCII encoded
- Subset of CSS selectors
- Different units of size other than pixels, e.g. points, picas, inches, ...

**Note:** The support of a specific feature also depends on the selected SVG driver. For more details please refer to the section *Limitations*.

### Non-supported features

Below are some major features of the SVG 1.1 specification which are currently not supported. This may change with future updates.

- Text and font handling
- Animations
- Patterns
- XSL
- URLs
- Clip paths
- Masking and blurring
- Scripts (e.g. ECMAScript, JavaScript, ...)

### CSS support

Rudimentary parsing of CSS rules and selectors is a part of the SVG parsing module.

The below listed selectors are supported.

Selector	Example	Description
.class	.intro	Selects all elements with class="intro".
#id	#firstname	Selects the element with id="firstname".
*	*	Selects all elements.

Please note that it's currently only possible to select one class at a time. This means a selector like `.class1.class2` would only select `class1`.

## 6.5.2 Configuration

### 6.5.2.1 API binding

In order to render SVGs with emWin, a 2D vector API has to be bound to emWin's SVG module. This is possible with both emWin source code and precompiled emWin libraries.

The following APIs are supported:

- Khronos OpenVG 1.1
- Vivante VGLite 2.0
- ThinkSilicon NemaVG 1.1.5 - 1.1.7
- Mikko Mononen's NanoVG

#### Step 1: Add source code

The first, obvious step is to add the code or static library and header files of the desired API to the project.

#### Step 2: Add define switches

The next step is to add defines to `GUI_Conf.h` to declare that the given source code of an API has been added.

API	Define(s)
Khronos OpenVG 1.1	<ul style="list-style-type: none"> <li>• <code>GUI_SVG_HAS_OPENVG</code></li> <li>• <code>GUI_SVG_HAS_EGL*</code></li> </ul>
Vivante VGLite 2.0	<ul style="list-style-type: none"> <li>• <code>GUI_SVG_HAS_VGLITE</code></li> </ul>
ThinkSilicon NemaVG 1.1.5 - 1.1.7	<ul style="list-style-type: none"> <li>• <code>GUI_SVG_HAS_NEMAVG</code></li> </ul>
Mikko Mononen's NanoVG	<ul style="list-style-type: none"> <li>• <code>GUI_SVG_HAS_NANOVG</code></li> </ul>

\*Optional, needs to be declared if OpenVG is used with EGL.

When using the emWin source code, the API binding is now done.

#### Step 3: Bind API (required for emWin libraries)

The next step is required when using a precompiled emWin library that was built without statically linking to the desired 2D vector API. In other words, during compilation of the emWin library one of the above `GUI_SVG_HAS_...` defines was **not** defined.

A structure that maps the desired API needs to be set during runtime. With this structure, the calls to the vector API will be redirected.

The API functions can be bound by either statically linking them to an API struct or dynamically linking and loading them into an API struct.

This is done with the routine `GUI_SVG_DRIVER_BindAPI()` or `GUI_SVG_DRIVER_BindDynamicAPI()`, respectively. Examples on how this step is done can be found under each respective SVG driver section.

#### Step 4: Select SVG driver (required for emWin libraries)

The final step is to select the desired SVG driver as the rendering backend for the SVG module. To do so, the routine `GUI_SVG_DRIVER_Select()` has to be called with one of the below symbols as the parameter to select a given driver.

API	Driver symbol
Khronos OpenVG 1.1	<code>GUI_SVG_DRIVER_OPENVG</code>
Vivante VGLite 2.0	<code>GUI_SVG_DRIVER_VGLITE</code>
ThinkSilicon NemaVG 1.1.5 - 1.1.7	<code>GUI_SVG_DRIVER_NEMAVG</code>
Mikko Mononen's NanoVG	<code>GUI_SVG_DRIVER_NANOVG</code>

### 6.5.2.2 Raster image module binding

The SVG module is able to render raster images embedded into an SVG. The images need to be embedded into an `<image>` tag, they are either Base64 or ASCII encoded. Please note that it is not possible to only link to a file.

#### Supported image formats

Below are the supported raster image formats. Each module needs to be activated manually, as to not automatically reference the modules even when they're not used.

There are two ways to activate an image module:

- During compile-time: By defining one of the below macros in `GUIConf.h` or
- During run time: By calling one of the below enabling routines.

Image Format	Define	Routine
PNG	GUI_SVG_ENABLE_PNG	GUI_SVG_EnablePNG()
JPEG	GUI_SVG_ENABLE_JPEG	GUI_SVG_EnableJPEG()
GIF	GUI_SVG_ENABLE_GIF	GUI_SVG_EnableGIF()
BMP	GUI_SVG_ENABLE_BMP	GUI_SVG_EnableBMP()

### 6.5.2.3 SVG module initialization

This section shows how to use some of the SVG API functions in the correct order to initialize emWin's SVG module.

Most of the functions are to be called optionally, as the initialization process is done automatically when the SVG API functions are used normally. But they can help separating the initialization workload from `GUI_SVG_Draw...()` function calls.

```
//
// Binding API functions to SVG driver if it was not done during
// compile-time.
//
if (GUI_SVG_DRIVER_HasBoundAPI(GUI_SVG_DRIVER_OPENVG) == 0) {
    //
    // Set the SVG driver to work with a desired version.
    //
    GUI_SVG_DRIVER_SetVersion(GUI_SVG_DRIVER_OPENVG, ...);
    //
    // Bind the functions to the driver.
    //
    GUI_SVG_DRIVER_BindAPI(GUI_SVG_DRIVER_OPENVG, ...);
}
//
// Optional: Hooking in custom code specific to the selected OpenVG implementation.
//
GUI_SVG_DRIVER_SetHooks(GUI_SVG_DRIVER_OPENVG, ...);
//
// Optional: Selecting and initializing SVG driver during runtime.
//
GUI_SVG_DRIVER_Select(GUI_SVG_DRIVER_OPENVG);
//
// Optional: Enable raster image modules during runtime. Only required if SVGs
// with embedded images are to be drawn and if this has not already been done
// during compile time.
//
GUI_SVG_EnablePNG();
GUI_SVG_EnableJPEG();
GUI_SVG_EnableGIF();
GUI_SVG_EnableBMP();
//
// Optional: Manually initializing the SVG module, which also initializes
// the currently selected SVG driver if this was not already done before.
```

```
//  
GUI_SVG_Enable(1);  
//  
// Drawing an SVG...  
//  
GUI_SVG_Draw(_acSVG, sizeof(_acSVG), 0, 0);
```

## 6.5.3 Drivers

The interface between the SVG standard and each 2D vector graphic API is implemented in SVG drivers. This section will explain each driver in detail.

### Initialization of hardware components

It depends on the SVG driver, if hardware components of the GPU need to be manually initialized or if they are initialized by the driver.

### API functions

The driver code either directly references the third-party API functions used by the driver (if the `GUI_SVG_HAS_...` define has been set) or indirectly through a function pointer table (set with `GUI_SVG_DRIVER_BindAPI()`).

### API versions

If the 2D vector API associated with a given driver receives an update in terms of new functionality, support for this functionality may also be added to the driver. Although, this requires the 2D vector API to have a version numbering scheme so that the driver can differentiate between the versions.

A driver has a minimum required version which is the default when no 2D vector API code is bound during compile time. This minimum/ default version is specified in each driver subsection below. Newer API versions supported by the driver are also listed there.

However, if the 2D vector API code is bound to the driver during compile time, the driver will know which version to use since it knows about the version defines in the API headers.

In order to set the driver to work with newer API version, the function `GUI_SVG_DRIVER_SetVersion()` has to be called before the API functions are bound. This is only required if emWin source code is not available, i.e. during compilation of the SVG driver the 2D vector API functions were **not** bound.

An example for this is `GUI_SVG_DRIVER_NEMAVG`, where multiple API versions are supported.

As a general rule of thumb, it makes sense to call `GUI_SVG_DRIVER_SetVersion()` whenever `GUI_SVG_DRIVER_BindAPI()` or `GUI_SVG_DRIVER_BindDynamicAPI()` is used:

```
#include <nema_vg_version.h>

GUI_SVG_DECLARE_NEMAVG_API(_API);
//
// This step is required for precompiled emWin libraries.
//
if (GUI_SVG_DRIVER_HasBoundAPI(GUI_SVG_DRIVER_NEMAVG) == 0) {
    GUI_SVG_DRIVER_SetVersion(GUI_SVG_DRIVER_NEMAVG,
                             NEMA_VG_MAJOR_VERSION,
                             NEMA_VG_MINOR_VERSION,
                             NEMA_VG_REVISION_VERSION);
    GUI_SVG_DRIVER_BindAPI(GUI_SVG_DRIVER_NEMAVG, &_API);
    GUI_SVG_DRIVER_Select(GUI_SVG_DRIVER_NEMAVG);
}
```

### 6.5.3.1 GUI\_SVG\_DRIVER\_VGLITE - Vivante VGLite driver

#### Initialization of hardware components

This driver does **not** initialize the GPU, this must be done before using the SVG module, e.g. in `LCDCConf.c`.

#### Supported API versions

- VGLite 2.0 (default)

#### API header files

Once the `GUI_SVG_HAS_VGLITE` define has been added to `GUIConf.h`, the required header files of the API will be included. The path to each header file is wrapped in a define which can be adapted in `GUIConf.h` as well, if required.

Below is a list of all header file defines that can be overwritten.

Define	Default value
<code>GUI_SVG_VGLITE_HEADER</code>	<code>&lt;vg_lite.h&gt;</code>
<code>GUI_SVG_VGLITE_OS_HEADER</code>	<code>&lt;vg_lite_os.h&gt;</code>

#### Driver selection during compile time (static linking, emWin source code)

If emWin source is available, this driver can be activated during compile time. To do so, add the following define to `GUI_Conf.h`:

```
#define GUI_SVG_HAS_VGLITE
```

#### Driver selection during runtime (static linking, emWin library)

If a precompiled library is used, the driver can be activated during runtime as well. To do so, the pointers to the API functions need to be declared in a structure and set to the SVG module.

```
#include "GUI_SVG_VGLite.h"
//
// Declare structure with API pointers
//
GUI_SVG_DECLARE_VGLITE_API(_API);
//
// Enables VGLite API for drawing SVGs.
//
GUI_SVG_DRIVER_BindAPI(GUI_SVG_DRIVER_VGLITE, &_API);
GUI_SVG_DRIVER_Select(GUI_SVG_DRIVER_VGLITE);
```

#### Driver selection during runtime (dynamic linking, emWin source code or library, VGLite dynamic library)

In case VGLite shall be loaded during runtime from a Dynamic Link Library (DLL), the below code can be used to load the API functions as well as activate the SVG driver.

```
#include "GUI_SVG_VGLite.h"
#include <windows.h>

/*****
 *
 *      Static data
 *
 *****/
*/
static HMODULE          _hDLL;
static GUI_SVG_VGLITE_API_STRUCT _VGLite_API;
```

```
/*
 *
 *      _cbLoadFunction
 */
static void (* _cbLoadFunction(const char * sFunction))(void) {
    return (void (*)(void))GetProcAddress(_hDLL, sFunction);
}

/*
 *
 *      _Init
 */
static void _Init(void) {
    //
    // Load DLL.
    //
    _hDLL = LoadLibrary("VGLite.dll");
    //
    // Load API and activate VGLite driver.
    //
    GUI_SVG_DRIVER_BindDynamicAPI(GUI_SVG_DRIVER_VGLITE, &_VGLite_API,
        _cbLoadFunction);
    GUI_SVG_DRIVER_Select(GUI_SVG_DRIVER_VGLITE);
}
```

### 6.5.3.2 GUI\_SVG\_DRIVER\_OPENVG - Khronos OpenVG driver

#### Initialization of hardware components

This driver does **not** initialize the GPU, this must be done before using the SVG module, e.g. in `LCDCConf.c`.

#### Supported API versions

- OpenVG 1.1 (default)

#### API header files

Once the corresponding `GUI_SVG_HAS_OPENVG` define (and optionally the `GUI_SVG_HAS_EGL` define) have been added to `GUIConf.h`, the required header files will be included. The path to each header file is wrapped in a define which can be adapted in `GUIConf.h` as well, if required.

Below is a list of all header file defines that can be overwritten.

Define	Default value
<code>GUI_SVG_OPENVG_HEADER</code>	<code>&lt;VG/openvg.h&gt;</code>
<code>GUI_SVG_VGU_HEADER</code>	<code>&lt;VG/vgu.h&gt;</code>
<code>GUI_SVG_EGL_HEADER</code>	<code>&lt;EGL/egl.h&gt;</code>

#### Driver selection during compile time (static linking, emWin source code)

If emWin source is available, this driver can be activated during compile time. To do so, add the following define(s) to `GUI_Conf.h`:

```
#define GUI_SVG_HAS_OPENVG
#define GUI_SVG_HAS_EGL // Optionally, add this if EGL is used
```

#### Driver selection during runtime (static linking, emWin library)

If a precompiled emWin library is used, the driver can be activated during runtime as well. To do so, the pointers to the API functions need to be declared in a structure and set to the SVG module.

The below code examples can be used if an OpenVG (and optionally EGL) implementation is used as source code.

If OpenVG is used with EGL, the below code can be used to select this driver:

```
#include "GUI_SVG_OpenVG.h"
//
// Declare structure with API pointers
//
GUI_SVG_DECLARE_OPENVG_AND_EGL_API(_API);
//
// Enables OpenVG and EGL APIs for drawing SVGs.
//
GUI_SVG_DRIVER_BindAPI(GUI_SVG_DRIVER_OPENVG, &_API);
GUI_SVG_DRIVER_Select(GUI_SVG_DRIVER_OPENVG);
```

To use OpenVG without EGL, use the below code:

```
#include "GUI_SVG_OpenVG.h"
//
// Declare structure with API pointers
//
GUI_SVG_DECLARE_OPENVG_API(_API);
//
// Enables OpenVG APIs for drawing SVGs.
```



```
//
GUI_SVG_DRIVER_BindAPI(GUI_SVG_DRIVER_OPENVG, &_API);
GUI_SVG_DRIVER_Select(GUI_SVG_DRIVER_OPENVG);
```

### Driver selection during runtime (dynamic linking, emWin source code or library, OpenVG dynamic library)

In case an OpenVG implementation shall be loaded during runtime from a Dynamic Link Library (DLL), the below code can be used to load the API functions as well as activate the SVG driver.

```
#include "GUI_SVG_OpenVG.h"
#include <windows.h>

/*****
 *
 *      Static data
 *
 *****/
*/
static HMODULE          _hDLL;
static GUI_SVG_OPENVG_API_STRUCT _OpenVG_API;

/*****
 *
 *      _cbLoadFunction
 *
 *****/
static void (* _cbLoadFunction(const char * sFunction))(void) {
    return (void (*)(void))GetProcAddress(_hDLL, sFunction);
}

/*****
 *
 *      _Init
 *
 *****/
static void _Init(void) {
    //
    // Load DLL.
    //
    _hDLL = LoadLibrary("ShivaVG.dll");
    //
    // Load API and activate OpenVG driver.
    //
    GUI_SVG_DRIVER_BindDynamicAPI(GUI_SVG_DRIVER_OPENVG, &_OpenVG_API,
                                  _cbLoadFunction);
    GUI_SVG_DRIVER_Select(GUI_SVG_DRIVER_OPENVG);
}
```

#### 6.5.3.2.1 Notes on the implementation

Below explained are some implementation caveats of the OpenVG driver that should be taken heed of.

##### Availability of EGL

Whether or not EGL is available in the OpenVG implementation to be used, the usage of EGL in emWin's OpenVG driver can be switched on or off. To do so

- during compile time: Don't add the `GUI_SVG_HAS_EGL` define to `GUIConf.h`.
- during runtime: Leave the pointer `pEGL` of `GUI_SVG_OPENVG_API_STRUCT` as `NULL`.

##### Direct rendering: OpenVG with EGL

When EGL is available in an OpenVG implementation, the OpenVG driver will try to directly render into the current render target. In order to render directly, EGLs pixmap surface API is used, rather than EGLs window surface API.

To create a pixmap surface with EGL, the routine `eglCreatePixmapSurface()` must be implemented.

### Indirect rendering: OpenVG without EGL

When EGL is not used, the routines `vgWritePixels()` and `vgReadPixels()` are used to read and write pixel data between OpenVG and emWin.

### Hooks

Some OpenVG implementations may require to initialize additional contexts. In order to hook in implementation specific code, `GUI_SVG_DRIVER_SetHooks()` may be used.

#### 6.5.3.2.2 ShivaVG

The emWin simulation contains the OpenVG implementation **ShivaVG** as a dynamic link library (DLL). This library has been added because it uses OpenGL as a rendering backend which offers a huge performance boost over Khronos' reference implementation.

### Licensing

The use of the ShivaVG library is subject to the GNU Lesser General Public License (LGPL) 2.1 license.

A modified version of the library is included in the emWin shipment as a dynamic link library (DLL). The source code of this modified version can be downloaded [on our website](#).

The original version of the library by Ivan Leben can be found on [GitHub](#).

### Configuration

The emWin simulation project contains a configuration file `GUI_SVG_ShivaVG_Win32.c` which automatically loads the ShivaVG DLL when it is present. After it has been loaded, the necessary SVG hooks are also set to initialize the library automatically.

#### Note

If the ShivaVG DLL is used, the define `GUI_SVG_HAS_OPENVG` must **not** be added to `GUI_Conf.h`!

### 6.5.3.3 GUI\_SVG\_DRIVER\_NEMAVG - ThinkSilicon NemaVG driver

#### Initialization of hardware components

This driver initializes the GPU by calling `nema_init()` beforehand.

#### Supported API versions

- NemaVG 1.1.5 (default)
- NemaVG 1.1.7

#### API header files

Once the corresponding `GUI_SVG_HAS_NEMAVG` define has been added to `GUIConf.h`, the required header files of the API will be included. The path to the header file is wrapped in a define which can be adapted in `GUIConf.h` as well, if required.

Below is a list of all header file defines that can be overwritten.

Define	Default value
<code>GUI_SVG_NEMA_VG_HEADER</code>	<code>&lt;nema_vg.h&gt;</code>
<code>GUI_SVG_NEMA_VG_VERSION_HEADER</code>	<code>&lt;nema_vg_version.h&gt;</code>

#### Driver selection during compile time (static linking, emWin source code)

If emWin source is available, this driver can be activated during compile time. To do so, add the following define to `GUI_Conf.h`:

```
#define GUI_SVG_HAS_NEMAVG
```

#### Driver selection during runtime (static linking, emWin library)

If a precompiled library is used, the driver can be activated during runtime as well. To do so, the pointers to the API functions need to be declared in a structure and set to the SVG module.

```
#include "GUI_SVG_NemaVG.h" // includes <nema_vg_version.h>
//
// Declare structure with API pointers
//
GUI_SVG_DECLARE_NEMAVG_API(_API);
//
// Enables NemaVG API for drawing SVGs.
//
GUI_SVG_DRIVER_SetVersion(GUI_SVG_DRIVER_NEMAVG,
                          NEMA_VG_MAJOR_VERSION,
                          NEMA_VG_MINOR_VERSION,
                          NEMA_VG_REVISION_VERSION);
GUI_SVG_DRIVER_BindAPI(GUI_SVG_DRIVER_NEMAVG, &_API);
GUI_SVG_DRIVER_Select(GUI_SVG_DRIVER_NEMAVG);
```

#### Driver selection during runtime (dynamic linking, emWin source code or library, NemaVG dynamic library)

In case NemaVG shall be loaded during runtime from a Dynamic Link Library (DLL), the below code can be used to load the API functions as well as activate the SVG driver.

```
#include "GUI_SVG_NemaVG.h"
#include <windows.h>

/*****
*
*     Static data
*
*****/
```

```

*****
*/
static HMODULE                _hDLL;
static GUI_SVG_NEMAVG_API_STRUCT _NemaVG_API;

/*****
*
*     _cbLoadFunction
*/
static void (* _cbLoadFunction(const char * sFunction))(void) {
    return (void (*)(void))GetProcAddress(_hDLL, sFunction);
}

/*****
*
*     _Init
*/
static void _Init(void) {
    //
    // Load DLL with NemaVG v1.1.7
    //
    _hDLL = LoadLibrary("NemaVG_1_1_7.dll");
    //
    // Set SVG driver to work with NemaVG version of DLL
    //
    GUI_SVG_DRIVER_SetVersion(GUI_SVG_DRIVER_NEMAVG, 1, 1, 7); // Set to v1.1.7
    //
    // Load API and activate NemaVG driver.
    //
    GUI_SVG_DRIVER_BindDynamicAPI(GUI_SVG_DRIVER_NEMAVG, &_NemaVG_API,
        _cbLoadFunction);
    GUI_SVG_DRIVER_Select(GUI_SVG_DRIVER_NEMAVG);
}

```

### 6.5.3.4 GUI\_SVG\_DRIVER\_NANOVG - NanoVG driver

#### Initialization of hardware components

This driver does **not** initialize the GPU, this must be done before using the SVG module, e.g. in `LCDCConf.c`.

#### Initialization of contexts

The driver also does not create any OpenGL contexts automatically. This must be done before the SVG driver is initialized. The creation and deletion of the OpenGL context can be hooked into the driver with the routine `GUI_SVG_DRIVER_SetHooks()`.

The driver will only initialize and provide an interface to NanoVG. It depends on the selected rendering backend which initialization function is called. More details about the rendering backend can be read below.

#### API header files

Once the corresponding `GUI_SVG_HAS_NANOVG` define has been added to `GUIConf.h`, the required header files of the API will be included. The path to the header file is wrapped in a define which can be adapted in `GUIConf.h` as well, if required.

Below is a list of all header file defines that can be overwritten.

Define	Default value
NanoVG header files	
<code>GUI_SVG_NANOVG_HEADER</code>	<code>&lt;nanovg.h&gt;</code>
<code>GUI_SVG_NANOVG_GL_HEADER</code>	<code>&lt;nanovg_gl.h&gt;</code>
OpenGL header files (rendering backend)	
<code>GUI_SVG_OPENGL2_HEADER</code>	<code>&lt;GL/gl.h&gt;</code>
<code>GUI_SVG_OPENGL3_HEADER</code>	<code>&lt;GL/gl3.h&gt;</code>
<code>GUI_SVG_OPENGL2_ES_HEADER</code>	<code>&lt;GLES2/gl2.h&gt;</code>
<code>GUI_SVG_OPENGL3_ES_HEADER</code>	<code>&lt;GLES3/gl3.h&gt;</code>

#### Render backend selection

The NanoVG API supports a wide range of OpenGL-based rendering backends which are the following:

- OpenGL 2.0
- OpenGL 3.0
- OpenGL ES 2.0
- OpenGL ES 3.0

Along with the `GUI_SVG_HAS_NANOVG` define in `GUIConf.h`, it's also possible to select the render backend used in emWin's SVG driver. To do so, the `GUI_SVG_NANOVG_RENDER_BACKEND` can be assigned one of the below values.

This is only required if a different rendering backend than OpenGL ES 2.0 shall be used, since this is the default selection if the define is not overridden.

Define	Rendering backend
<code>GUI_SVG_NANOVG_BACKEND_GL2</code>	OpenGL 2.0
<code>GUI_SVG_NANOVG_BACKEND_GL3</code>	OpenGL 3.0
<code>GUI_SVG_NANOVG_BACKEND_GLES2</code>	OpenGL ES 2.0
<code>GUI_SVG_NANOVG_BACKEND_GLES3</code>	OpenGL ES 3.0

## Driver selection during compile time (static linking, emWin source code)

If emWin source is available, this driver can be activated during compile time. To do so, add the following define to `GUI_Conf.h`:

```
#define GUI_SVG_HAS_NANOVG
#define GUI_SVG_NANOVG_RENDER_BACKEND GUI_SVG_NANOVG_BACKEND_GLES2
```

## Driver selection during runtime (static linking, emWin library)

If a precompiled library is used, the driver can be activated during runtime as well. To do so, the pointers to the API functions need to be declared in a structure and set to the SVG module.

```
#include "GUI_SVG_NanoVG.h"
//
// Declare structure with API pointers
//
GUI_SVG_DECLARE_NANOVG_API(_API);
//
// Enables NanoVG API for drawing SVGs.
//
GUI_SVG_DRIVER_BindAPI(GUI_SVG_DRIVER_NANOVG, &_API);
GUI_SVG_DRIVER_Select(GUI_SVG_DRIVER_NANOVG);
```

## Driver selection during runtime (dynamic linking, emWin source code or library, NanoVG dynamic library)

In case NanoVG shall be loaded during runtime from a Dynamic Link Library (DLL), the below code can be used to load the API functions as well as activate the SVG driver.

### Note

During compilation time the selection of NanoVG's rendering backend must be made. This cannot be changed during runtime, therefore `GUI_SVG_DRIVER_BindDynamicAPI()` will always load the functions of the default backend which is OpenGL ES 2.0.

```
#include "GUI_SVG_NanoVG.h"
#include <windows.h>

/*****
 *
 *      Static data
 *
 *****/
static HMODULE          _hDLL;
static GUI_SVG_NANOVG_API_STRUCT _NanoVG_API;

/*****
 *
 *      _cbLoadFunction
 *
 *****/
static void (* _cbLoadFunction(const char * sFunction))(void) {
    return (void (*)(void))GetProcAddress(_hDLL, sFunction);
}

/*****
 *
 *      _Init
 *
 *****/
static void _Init(void) {
    //
```

```
// Load DLL.  
//  
_hDLL = LoadLibrary("NanoVG.dll");  
//  
// Load API and activate NanoVG driver.  
//  
GUI_SVG_DRIVER_BindDynamicAPI(GUI_SVG_DRIVER_NANOVG, &_NanoVG_API,  
                             _cbLoadFunction);  
GUI_SVG_DRIVER_Select(GUI_SVG_DRIVER_NANOVG);  
}
```

## 6.5.4 Affine transformations

Affine transformations are a type of geometric transformations that preserve parallelism and ratios of distances. They can be used to manipulate SVG elements, such as scaling, rotating, skewing, or translating them. Affine transformations are expressed by 3x3 matrices that map coordinates from one coordinate system to another.

emWin's SVG API provides three different ways to apply affine transformations to an SVG, which are described below. All API functions are listed and described in more detail later in this chapter under *SVG API* on page 539.

### 6.5.4.1 Method 1: Using the basic API

Using one of the basic API functions allows to draw an SVG with only one function call and also applying some basic affine transformations to it.

An example would be:

```
//
// Draw the Ghostscript tiger at 50,50 scaled and with
// an angle.
//
GUI_SVG_DrawScaledRotated(_acTiger, sizeof(_acTiger),
                          50, 50, // Position
                          0.5f, // Scaled to 50%
                          20.0f); // Rotated CCW by 20\deg around center point.
```

### 6.5.4.2 Method 2: Using the handle API

Creating an SVG handle allows more complex affine transformations in a step-by-step fashion. The transformations may be in any order, why is explained in more detail further below.

```
GUI_SVG_Handle hSvg;

hSvg = GUI_SVG_Create(_acTiger, sizeof(_acTiger));
//
// Perform transformations, order can be arbitrary.
//
GUI_SVG_Scale(hSvg, 1.1f, 1.0f);
GUI_SVG_Translate(hSvg, 30, 0);
GUI_SVG_Rotate(hSvg, 90.0f);
GUI_SVG_DrawH(hSvg, 0, 0);
```

#### Note on the transformation order

Matrix multiplication is not commutative, this means it is crucial in which order the transformations such as scaling, rotation, etc. are performed.

Internally, the transformations are performed in the usual order as in the formula below. M is the resulting transformation matrix applied to the SVG, S is the scaling matrix, R is the rotation matrix and T is the translation matrix.

$$M = S * R * T$$

However, the user may call the SVG transformation routines in any order. Each transformation type is applied to a separate matrix. During drawing with `GUI_SVG_DrawH()`, all matrices are applied to the SVG in the correct order.

But note that there is only one matrix per transformation type, e.g. only one matrix for scaling. So multiple calls won't override the previous operation. For instance, the two below calls won't result in a scaling of 25%, but rather 12,5%.

```
GUI_SVG_Scale(hSvg, 0.5f, 0.5f);
GUI_SVG_Scale(hSvg, 0.25f, 0.25f); // Will be multiplied with the scaling factors
// set in the previous line.
```



To reset all affine transformation matrices of an SVG object, `GUI_SVG_Identity()` may be used.

### 6.5.4.3 Method 3: Setting a transformation matrix directly

When using an SVG object, alternatively to using the SVG API to perform the transformations, the user may also perform the transformations themselves and set a custom transformation matrix.

When this is done, only this matrix will be used for the transformations. Other transformations set by e.g. `GUI_SVG_Scale()` won't be applied.

Note that here the usual transformation order applies here. Below is an example on how to use a custom matrix:

```
GUI_SVG_Handle hSvg;
GUI_MATRIX     Mat;

hSvg = GUI_SVG_Create(_acTiger, sizeof(_acTiger));
//
// Apply transformations to custom matrix in the correct order.
// Rotate CW around origin and scale.
//
GUI_MATRIX_Identity(&Mat);
GUI_MATRIX_Rotate(&Mat, -45.0f);
GUI_MATRIX_Scale(&Mat, 1.25f, 1.25f);
//
// Set matrix and draw.
//
GUI_SVG_Transform(hSvg, &Mat);
GUI_SVG_DrawH(hSvg, &Mat);
```

## 6.5.5 Caching mode

### Note

Please note that the caching mode requires the Memory Device add-on!

For systems with lots of RAM available or systems that don't use `GUIDRV_Lin` as the display driver, a caching mode has been introduced to the SVG module.

When caching mode has been enabled with `GUI_SVG_EnableCacheMode()` the current state of the SVG will be rendered into an internal bitmap before it is drawn with `GUI_SVG_DrawH()`.

Optionally, this rendering step can be extracted from `GUI_SVG_DrawH()` by calling `GUI_SVG_Render()` beforehand.

Since the SVG will be rendered into a memory device which is directly accessible in memory, caching mode is an alternative for systems without a directly accessible framebuffer.

### Example

Below is a simple code example that shows how to render an SVG using cache mode.

```
GUI_SVG_Handle hSVG;
//
// Create SVG handle with caching mode.
//
hSVG = GUI_SVG_Create(_acTiger, sizeof(_acTiger));
GUI_SVG_EnableCacheMode(hSVG, 1);
//
// Optional: If supported color depth does not support
// transparency, a background color should be set to fill
// the bitmap with.
//
GUI_SVG_SetBkColor(hSVG, GUI_WHITE);
//
// Optional: Render the SVG beforehand.
//
GUI_SVG_Render(hSVG);
//
// Draw SVG, will draw the bitmap rendered in the prev. line.
//
GUI_SVG_DrawH(hSVG, 0, 0);
```

## 6.5.6 Memory footprint

Based on which SVG features are used, during parsing internal data is dynamically allocated and associated with an SVG handle.

The memory footprint of an SVG handle is composed of the following:

Component	Number of bytes
SVG handle	380
1x gradient	80 (linear) 84 (radial)
1x CSS rule	Size of the rule string + size of the attribute and value strings + 12 bytes
1x embedded raster image	4 byte for each pixel of the raster image.
Cache bitmap	4 byte for each pixel of the bitmap, size equals to the SVG's boundary box.
SVG file buffer (when the file is read from external memory)	512 (default), or size set with <code>GUI_SVG_SetFileBufferSize()</code> .

## 6.5.7 Limitations

### Render target limitations

The SVG module (rather, the selected 2D vector API) can only render into a buffer that is directly accessible through a pointer to a memory block. This can be either the framebuffer or the currently selected memory device.

**Note:** This limitation can be bypassed by using cache mode (see *Caching mode* on page 522) if the SVG driver supports rendering into memory devices.

Render target	OpenVG	VGLite	NemaVG	NanoVG
Framebuffer	✓	✓	✓	✓
Memory device	✓	✓	✓	✗

### Color format limitations

The rendering of SVGs is limited to render targets with a certain color conversion, depending on the selected SVG driver. Any other color conversions that are not listed below are not supported.

**Note:** This limitation can be bypassed by using cache mode (see *Caching mode* on page 522) if the SVG driver supports rendering into memory devices.

Color format	OpenVG	VGLite	NemaVG	NanoVG
32 bits per pixel				
GUICC_M8888I	✓	✓	✓	✗
GUICC_8888I	✓	✓	✓	✓
24 bits per pixel				
GUICC_M888	✗	✗	✓	✗
GUICC_888	✗	✗	✓	✗
16 bits per pixel				
GUICC_M565	✓	✓	✓	✗
GUICC_565	✓	✓	✓	✗
GUICC_M555	✗	✗	✓	✗
GUICC_555	✗	✗	✓	✗

### Feature limitations

Below is a detailed list of SVG features that are handled by the SVG drivers. The table shows the relevant tags (e.g. <tag>) and attributes (e.g. attribute: value).

Since not all APIs support the same feature subset, it is recommended to check the SVG file for definitions and whether they are supported by the selected API.

For details about the below listed features, please refer to the SVG 1.1 specification.

SVG feature	OpenVG	VGLite	NemaVG	NanoVG
Primitives (stroking and filling)				
Lines	✓	✓	✓	✓
Rectangles	✓	✓	✓	✓
Rounded rectangles	✓	✓	✓	✓

SVG feature	OpenVG	VGLite	NemaVG	NanoVG
Ellipses	✓	✓	✓	✓
Circles	✓	✓	✓	✓
Quadratic curves	✓	✓	✓	✓
Cubic curves	✓	✓	✓	✓
Arcs	✓	✓	✓	✓ *1
Line cap styles				
stroke-linecap: <b>butt</b>	✓	✓	✓	✓
stroke-linecap: <b>round</b>	✓	✓	✓ *2	✓
stroke-linecap: <b>square</b>	✓	✓	✓ *2	✓
Line join styles				
stroke-linejoin: <b>miter</b>	✓	✓	✓ *2	✓
stroke-linejoin: <b>round</b>	✓	✓	✓ *2	✓
stroke-linejoin: <b>bevel</b>	✓	✓	✓	✓
Line dashing				
stroke-dasharray	✓	✓	✗	✗
Gradients (stroking and filling)				
<linearGradient>	✓	✓	✓	✗
<radialGradient>	✓	✓	✓	✗
<stop>	✓	✓	✓	✗
fx, fy (radial gradient focal points)	✓	✓	✗	✗
spread: <b>pad</b>	✓	✓	✓	✗
spread: <b>repeat</b>	✓	✓	✗	✗
spread: <b>reflect</b>	✓	✓	✗	✗
Miscellaneous features				
<image> (PNG, JPEG, BMP, GIF)	✓	✓	✓	✓

\*1 No native support of arc segments. The arcs are approximated with Bezier curves so that they can be rendered by the driver.

\*2 Requires NemaVG 1.1.7 or newer.

## 6.5.8 GUI\_MATRIX API

The SVG coordinate system heavily relies on matrices. To simplify basic matrix calculations, the below API functions have been introduced.

### Functions

Routine	Description
<code>GUI_MATRIX_Equals()</code>	Compares if the values of two 3x3 matrices are equal.
<code>GUI_MATRIX_GetCellPtr()</code>	Returns a pointer to a matrix cell based on a row and column index.
<code>GUI_MATRIX_Initialize()</code>	Initializes the values of a given 3x3 matrix.
<code>GUI_MATRIX_Identity()</code>	Sets the matrix to the identity matrix.
<code>GUI_MATRIX_Multiply()</code>	Multiplies a given 3x3 matrix with another 3x3 matrix.
<code>GUI_MATRIX_MultiplyPoint()</code>	Multiplies a given point in floating point coordinates with a 3x3 matrix.
<code>GUI_MATRIX_Rotate()</code>	Rotates a given 3x3 matrix clockwise or counter-clockwise by the given angle a.
<code>GUI_MATRIX_Scale()</code>	Scales a given 3x3 matrix by sx and sy.
<code>GUI_MATRIX_Shear()</code>	Shears a given 3x3 matrix by shx and shy.
<code>GUI_MATRIX_Translate()</code>	Translates a given 3x3 matrix by tx and ty.

### Data structures

Structure	Description
<code>GUI_MATRIX</code>	A column-major 3x3 matrix used for all kinds of affine transformations.
<code>GUI_POINTF</code>	Defines a point in floating point coordinates.

## 6.5.8.1 Functions

### 6.5.8.1.1 GUI\_MATRIX\_Equals()

#### Description

Compares if the values of two 3x3 matrices are equal.

#### Prototype

```
int GUI_MATRIX_Equals(const GUI_MATRIX * p0,  
                     const GUI_MATRIX * p1);
```

#### Parameters

Parameter	Description
<code>p0</code>	<b>in</b> Pointer to a GUI_MATRIX structure to be compared with <code>p1</code> .
<code>p1</code>	<b>in</b> Pointer to a GUI_MATRIX structure to be compared with <code>p0</code> .

#### Return value

- 1 The matrices `p0` and `p1` are equal.
- 0 The matrices `p0` and `p1` are not equal.

### 6.5.8.1.2 GUI\_MATRIX\_GetCellPtr()

#### Description

Returns a pointer to a matrix cell based on a row and column index.

#### Prototype

```
float *GUI_MATRIX_GetCellPtr(GUI_MATRIX * pMatrix,  
                             unsigned Row,  
                             unsigned Col);
```

#### Parameters

Parameter	Description
<code>pMatrix</code>	<b>in</b> Pointer to a GUI_MATRIX structure.
<code>Row</code>	Zero-based row index in the matrix.
<code>Col</code>	Zero-based column index in the matrix.

#### Return value

= NULL Invalid parameters.  
≠ NULL Pointer to the matrix cell at `Row` and `Col`.



### 6.5.8.1.3 GUI\_MATRIX\_Initialize()

#### Description

Initializes the values of a given 3x3 matrix.

#### Prototype

```
void GUI_MATRIX_Initialize(GUI_MATRIX * pMatrix,
                          float      sx,
                          float      shx,
                          float      tx,
                          float      shy,
                          float      sy,
                          float      ty,
                          float      w0,
                          float      w1,
                          float      w2);
```

#### Parameters

Parameter	Description
<code>pMatrix</code>	<b>out</b> Pointer to a GUI_MATRIX structure that is filled with the given values.
<code>sx</code>	Value to be copied to <code>pMatrix-&gt;sx</code> .
<code>shx</code>	Value to be copied to <code>pMatrix-&gt;shx</code> .
<code>tx</code>	Value to be copied to <code>pMatrix-&gt;tx</code> .
<code>shy</code>	Value to be copied to <code>pMatrix-&gt;shy</code> .
<code>sy</code>	Value to be copied to <code>pMatrix-&gt;sy</code> .
<code>ty</code>	Value to be copied to <code>pMatrix-&gt;ty</code> .
<code>w0</code>	Value to be copied to <code>pMatrix-&gt;w0</code> .
<code>w1</code>	Value to be copied to <code>pMatrix-&gt;w1</code> .
<code>w2</code>	Value to be copied to <code>pMatrix-&gt;w2</code> .

#### Additional information

This routine can be used for a better readable initialization of the matrix:

```
GUI_MATRIX Mat;
GUI_MATRIX_Initialize(&Mat, 1.0f, 0.0f, 0.0f, // sx, shx, tx
                    0.0f, 1.0f, 0.0f, // shy, sy, ty
                    0.0f, 0.0f, 1.0f); // w0, w1, w2
```

#### 6.5.8.1.4 GUI\_MATRIX\_Identity()

##### Description

Sets the matrix to the identity matrix.

##### Prototype

```
void GUI_MATRIX_Identity(GUI_MATRIX * pMatrix);
```

##### Parameters

Parameter	Description
<code>pMatrix</code>	<b>out</b> Pointer to a GUI_MATRIX structure that is filled with the identity matrix.

### 6.5.8.1.5 GUI\_MATRIX\_Multiply()

#### Description

Multiplies a given 3x3 matrix with another 3x3 matrix.

#### Prototype

```
void GUI_MATRIX_Multiply(    GUI_MATRIX * pMatrix,  
                           const GUI_MATRIX * pMult);
```

#### Parameters

Parameter	Description
<code>pMatrix</code>	<code>in/out</code> Pointer to a <code>GUI_MATRIX</code> structure that is to be multiplied with <code>pMult</code> .
<code>pMult</code>	<code>in</code> Matrix that is multiplied with <code>pMatrix</code> .

### 6.5.8.1.6 GUI\_MATRIX\_MultiplyPoint()

#### Description

Multiplies a given point in floating point coordinates with a 3x3 matrix.

#### Prototype

```
void GUI_MATRIX_MultiplyPoint(const GUI_MATRIX * pMatrix,  
                             GUI_POINTF * pPoint);
```

#### Parameters

Parameter	Description
<code>pMatrix</code>	<b>in</b> Pointer to a GUI_MATRIX structure that is to be multiplied with <code>pPoint</code> .
<code>pPoint</code>	<b>in/out</b> Pointer to a GUI_POINTF structure to be multiplied with <code>pMatrix</code> .

### 6.5.8.1.7 GUI\_MATRIX\_Rotate()

#### Description

Rotates `a` given 3x3 matrix clockwise or counter-clockwise by the given angle `a`.

- For positive angles, the rotation is  $a^\circ$  counter-clockwise (CCW).
- For negative angles, the rotation is  $-a^\circ$  clockwise (CW).

#### Prototype

```
void GUI_MATRIX_Rotate(GUI_MATRIX * pMatrix,  
                      float      a);
```

#### Parameters

Parameter	Description
<code>pMatrix</code>	<code>in/out</code> Pointer to a <code>GUI_MATRIX</code> structure that is to be rotated.
<code>a</code>	Angle in degrees to rotate the matrix with.

### 6.5.8.1.8 GUI\_MATRIX\_Scale()

#### Description

Scales a given 3x3 matrix by `sx` and `sy`.

#### Prototype

```
void GUI_MATRIX_Scale(GUI_MATRIX * pMatrix,  
                      float      sx,  
                      float      sy);
```

#### Parameters

Parameter	Description
<code>pMatrix</code>	<code>in/out</code> Pointer to a <code>GUI_MATRIX</code> structure that is to be scaled.
<code>sx</code>	Scaling factor in x.
<code>sy</code>	Scaling factor in y.

### 6.5.8.1.9 GUI\_MATRIX\_Shear()

#### Description

Shears a given 3x3 matrix by `shx` and `shy`.

#### Prototype

```
void GUI_MATRIX_Shear(GUI_MATRIX * pMatrix,  
                      float      shx,  
                      float      shy);
```

#### Parameters

Parameter	Description
<code>pMatrix</code>	<code>in/out</code> Pointer to a <code>GUI_MATRIX</code> structure that is to be sheared.
<code>shx</code>	Shearing factor in x.
<code>shy</code>	Shearing factor in y.

### 6.5.8.1.10 GUI\_MATRIX\_Translate()

#### Description

Translates a given 3x3 matrix by `tx` and `ty`.

#### Prototype

```
void GUI_MATRIX_Translate(GUI_MATRIX * pMatrix,  
                          float      tx,  
                          float      ty);
```

#### Parameters

Parameter	Description
<code>pMatrix</code>	<code>in/out</code> Pointer to a <code>GUI_MATRIX</code> structure that is to be translated.
<code>tx</code>	Translation distance in x.
<code>ty</code>	Translation distance in y.



## 6.5.8.2 Data structures

### 6.5.8.2.1 GUI\_MATRIX

#### Description

A column-major 3x3 matrix used for all kinds of affine transformations.

#### Type definition

```
typedef struct {
    float  sx;
    float  shy;
    float  w0;
    float  shx;
    float  sy;
    float  w1;
    float  tx;
    float  ty;
    float  w2;
} GUI_MATRIX;
```

#### Structure members

Member	Description
<code>sx</code>	The scaling factor in the x-direction.
<code>shy</code>	The shearing factor in the y-direction.
<code>w0</code>	Should be left as 0.0F to ensure affinity.
<code>shx</code>	The shearing factor in the x-direction.
<code>sy</code>	Scaling factor in y.
<code>w1</code>	Should be left as 0.0F to ensure affinity.
<code>tx</code>	The translation factor in the x-direction.
<code>ty</code>	The translation factor in the y-direction.
<code>w2</code>	Should be left as 1.0F to ensure affinity.

#### Additional information

emWin uses column-major matrices which means that the matrix elements are stored in columns from top to bottom and left to right.

The order is the same as in OpenVG, therefore `GUI_MATRIX` is implicitly convertible to the 3x3 matrix type used in OpenVG.

### 6.5.8.2.2 GUI\_POINTF

#### Description

Defines a point in floating point coordinates.

#### Type definition

```
typedef struct {  
    float x;  
    float y;  
} GUI_POINTF;
```

#### Structure members

Member	Description
<a href="#">x</a>	X coordinate in floating points.
<a href="#">y</a>	Y coordinate in floating points.

## 6.5.9 SVG API

The table below lists the available SVG routines. All functions are listed in alphabetical order within their respective categories. Detailed descriptions of the routines can be found in the sections that follow.

### Notes on the SVG API

The SVG API provides a “basic API” which allows drawing of SVG files the same way as any other image file format in emWin, for example `GUI_SVG_Draw()` or `GUI_SVG_DrawEx()`. Here, only one function call is required and no handles need to be created.

Additionally, there is also handle-oriented API which allows the usage of SVG files as handles. The advantage here is that when drawing the SVG, the global SVG data does not need to be read every time the file is drawn, because this is done only once during the creation of the handle. Furthermore, the handle-based API is required if the user wants to perform affine matrix transformations themselves.

### Functions

Routine	Description
Basic routines	
<code>GUI_SVG_Draw()</code>	Draws a given SVG file from accessible memory at a given position.
<code>GUI_SVG_DrawEx()</code>	Draws a given SVG file from external memory at a given position.
<code>GUI_SVG_DrawScaled()</code>	Draws a given SVG file from accessible memory at a given position with a the given scale factor.
<code>GUI_SVG_DrawScaledEx()</code>	Draws a given SVG file from external memory at a given position with a given scaling factor.
<code>GUI_SVG_DrawScaledRotated()</code>	Draws a given SVG file from accessible memory at a given position with a the given scale factor and rotation angle.
<code>GUI_SVG_DrawScaledRotatedEx()</code>	Draws a given SVG file from external memory at a given position with a given scaling factor.
<code>GUI_SVG_GetInfo()</code>	Fills an information structure from a file in accessible memory.
<code>GUI_SVG_GetInfoEx()</code>	Fills an information structure from a file in non-accessible memory.
Handle-related routines	
<code>GUI_SVG_Create()</code>	Creates an SVG handle from a file located in addressable memory.
<code>GUI_SVG_CreateEx()</code>	Creates an SVG handle from a file in external memory.
<code>GUI_SVG_Delete()</code>	Deletes an SVG handle.
<code>GUI_SVG_DrawH()</code>	Renders an SVG file at the given position.
<code>GUI_SVG_EnableCacheMode()</code>	Enables or disables caching mode for this SVG handle.
<code>GUI_SVG_GetInfoH()</code>	Fills an information structure from an SVG handle.
<code>GUI_SVG_Identity()</code>	Resets the matrices related to the SVG object to the identity matrix.

Routine	Description
<code>GUI_SVG_Render()</code>	Renders the SVG into the internal memory device.
<code>GUI_SVG_Rotate()</code>	Sets the counter-clockwise rotation angle for rotations around the center point.
<code>GUI_SVG_RotateEx()</code>	Sets the counter-clockwise rotation angle for rotations around any given point.
<code>GUI_SVG_Scale()</code>	Sets scaling factors in the X and Y direction that will be used when drawing an SVG with <code>GUI_SVG_DrawH()</code> .
<code>GUI_SVG_ScaleToSize()</code>	Sets the scaling factors so that the SVG is draw in the dimensions <code>xSize</code> and <code>ySize</code> when <code>GUI_SVG_DrawH()</code> is called.
<code>GUI_SVG_SetBkColor()</code>	Sets a background color used for filling the internal cache bitmap.
<code>GUI_SVG_Transform()</code>	Sets a custom transformation matrix.
<code>GUI_SVG_Translate()</code>	Sets the translation factors that will be used when drawing an SVG with <code>GUI_SVG_DrawH()</code> .
<b>SVG module related routines</b>	
<code>GUI_SVG_Enable()</code>	Initializes or de-initializes the SVG module and the currently selected SVG driver.
<code>GUI_SVG_EnablePNG()</code>	Enables the drawing of PNGs that are embedded into SVGs.
<code>GUI_SVG_EnableJPEG()</code>	Enables the drawing of JPEGs that are embedded into SVGs.
<code>GUI_SVG_EnableGIF()</code>	Enables the drawing of GIFs that are embedded into SVGs.
<code>GUI_SVG_EnableBMP()</code>	Enables the drawing of BMPs that are embedded into SVGs.
<code>GUI_SVG_SetDPI()</code>	Sets the DPI (dots per inch) value used for parsing and displaying SVGs.
<code>GUI_SVG_SetFileBufferSize()</code>	Sets the byte size of the buffer that will be used when an SVG file is read from external memory.
<b>SVG driver related routines</b>	
<code>GUI_SVG_DRIVER_BindAPI()</code>	Binds the required 2D vector API functions to the given SVG driver.
<code>GUI_SVG_DRIVER_BindDynamicAPI()</code>	Dynamically loads and binds the required 2D vector API functions to the given SVG driver.
<code>GUI_SVG_DRIVER_GetSelected()</code>	Returns the currently selected SVG driver.
<code>GUI_SVG_DRIVER_HasBoundAPI()</code>	Checks if the given SVG driver has bound API functions.
<code>GUI_SVG_DRIVER_Select()</code>	Selects a given driver for rendering SVGs.
<code>GUI_SVG_DRIVER_SetHooks()</code>	Sets the desired hooks functions to a given SVG driver.
<code>GUI_SVG_DRIVER_SetVersion()</code>	Sets a desired API version to the given SVG driver.

## Data structures

Structure	Description
<a href="#">GUI_SVG_BBOX</a>	Boundary box of an SVG based on the currently set parameters like position, scaling, rotation, etc.
<a href="#">GUI_SVG_HOOKS</a>	Allows to hook in into various spots during the SVG drawing process.
<a href="#">GUI_SVG_INFO</a>	Information about an SVG document, generated by the <code>GUI_SVG_GetInfo...()</code> functions.
<a href="#">GUI_SVG_VIEWBOX</a>	The SVG's view box, as it is defined by the <code>viewBox</code> attribute in the <code>&lt;svg&gt;</code> tag.
<a href="#">GUI_SVG_EGL_API_STRUCT</a>	Maps the required EGL functions of the Khronos OpenVG API.
<a href="#">GUI_SVG_GL_API_STRUCT</a>	Maps the required OpenGL functions required for NanoVG.
<a href="#">GUI_SVG_NANOVG_API_STRUCT</a>	Maps the required functions of the NanoVG API.
<a href="#">GUI_SVG_NEMAVG_API_STRUCT</a>	Maps the required functions of the ThinkSilicon NemaVG API.
<a href="#">GUI_SVG_OPENVG_API_STRUCT</a>	Maps the required functions of the Khronos OpenVG API.
<a href="#">GUI_SVG_VGLITE_API_STRUCT</a>	Maps the required functions of the Vivante VGLite API.

## Prototypes

Prototype	Description
<a href="#">GUI_SVG_GET_DATA_FUNC</a>	GetData function used for the SVG format, for more details see <code>GUI_GET_DATA_FUNC_II</code> .
<a href="#">GUI_SVG_LOAD_API_CALLBACK</a>	Callback used to load a given routine.

## Defines

Macro	Description
<a href="#">GUI_SVG_DECLARE_EGL_API</a>	Macro to define a structure of the type <code>GUI_SVG_EGL_API_STRUCT</code> filled with the correct function pointers.
<a href="#">GUI_SVG_DECLARE_NANOVG_API</a>	Macro to define a structure of the type <code>GUI_SVG_EGL_API_STRUCT</code> filled with the correct function pointers.
<a href="#">GUI_SVG_DECLARE_NEMAVG_API</a>	Macro to define a structure of the type <code>GUI_SVG_NEMAVG_API_STRUCT</code> filled with the correct function pointers.
<a href="#">GUI_SVG_DECLARE_OPENVG_API</a>	Macro to define a structure of the type <code>GUI_SVG_OPENVG_API_STRUCT</code> filled with the correct function pointers.
<a href="#">GUI_SVG_DECLARE_OPENVG_AND_EGL_API</a>	Macro to define a structure of the type <code>GUI_SVG_OPENVG_API_STRUCT</code> filled with the correct function pointers as well as a pointer to a <code>GUI_SVG_EGL_API_STRUCT</code> structure.

Macro	Description
<code>GUI_SVG_DECLARE_VGLITE_API</code>	Macro to define a structure of the type <code>GUI_SVG_VGLITE_API_STRUCT</code> filled with the correct function pointers.
<code>GUI_SVG_DRIVER</code>	All available SVG drivers for run-time usage with the <code>GUI_SVG_DRIVER_..</code>

## 6.5.9.1 Basic routines

### 6.5.9.1.1 GUI\_SVG\_Draw()

#### Description

Draws a given SVG file from accessible memory at a given position.

#### Prototype

```
int GUI_SVG_Draw(const void * pFile,  
                U32      FileSize,  
                float   x,  
                float   y);
```

#### Parameters

Parameter	Description
<code>pFile</code>	<b>in</b> Pointer to a SVG file in binary form.
<code>FileSize</code>	Byte size of the array pointed to by <code>pFile</code> .
<code>x</code>	X-position to draw SVG in current window.
<code>y</code>	Y-position to draw SVG in current window.

#### Return value

0        On success.  
1        On error.

### 6.5.9.1.2 GUI\_SVG\_DrawEx()

#### Description

Draws a given SVG file from external memory at a given position.

#### Prototype

```
int GUI_SVG_DrawEx(GUI_SVG_GET_DATA_FUNC * pfGetData,  
                  void * p,  
                  float x,  
                  float y);
```

#### Parameters

Parameter	Description
<code>pfGetData</code>	<b>in</b> Function pointer to a GetData function. For more details, please refer to the chapter <i>FileAccess</i> on page 3219.
<code>p</code>	<b>in</b> User-defined pointer passed to <code>pfGetData</code> .
<code>x</code>	X-position to draw SVG in current window.
<code>y</code>	Y-position to draw SVG in current window.

#### Return value

0 On success.  
1 On error.



### 6.5.9.1.3 GUI\_SVG\_DrawScaled()

#### Description

Draws a given SVG file from accessible memory at a given position with a the given scale factor.

#### Prototype

```
int GUI_SVG_DrawScaled(const void * pFile,  
                      U32      FileSize,  
                      float    x,  
                      float    y,  
                      float    Scale);
```

#### Parameters

Parameter	Description
<a href="#">pFile</a>	<b>in</b> Pointer to a SVG file in binary form.
<a href="#">FileSize</a>	Byte size of the array pointed to by <a href="#">pFile</a> .
<a href="#">x</a>	X-position to draw SVG in current window.
<a href="#">y</a>	Y-position to draw SVG in current window.
<a href="#">Scale</a>	<a href="#">Scale</a> factor applied to X and Y.

#### Return value

0        On success.  
1        On error.

### 6.5.9.1.4 GUI\_SVG\_DrawScaledEx()

#### Description

Draws a given SVG file from external memory at a given position with a given scaling factor.

#### Prototype

```
int GUI_SVG_DrawScaledEx(GUI_SVG_GET_DATA_FUNC * pfGetData,
                        void * p,
                        float x,
                        float y,
                        float Scale);
```

#### Parameters

Parameter	Description
<code>pfGetData</code>	<b>in</b> Function pointer to a GetData function. For more details, please refer to the chapter <i>FileAccess</i> on page 3219.
<code>p</code>	<b>in</b> User-defined pointer passed to <code>pfGetData</code> .
<code>x</code>	X-position to draw SVG in current window.
<code>y</code>	Y-position to draw SVG in current window.
<code>Scale</code>	Scaling factor used for X and Y.

#### Return value

0      On success.  
1      On error.

### 6.5.9.1.5 GUI\_SVG\_DrawScaledRotated()

#### Description

Draws a given SVG file from accessible memory at a given position with a the given scale factor and rotation angle.

The SVG will be rotated around its center point in the counter- clockwise direction.

#### Prototype

```
int GUI_SVG_DrawScaledRotated(const void * pFile,
                              U32      FileSize,
                              float    x,
                              float    y,
                              float    Scale,
                              float    Angle);
```

#### Parameters

Parameter	Description
<code>pFile</code>	<b>in</b> Pointer to a SVG file in binary form.
<code>FileSize</code>	Byte size of the array pointed to by <code>pFile</code> .
<code>x</code>	X-position to draw SVG in current window.
<code>y</code>	Y-position to draw SVG in current window.
<code>Scale</code>	<code>Scale</code> factor applied to X and Y.
<code>Angle</code>	Rotation angle for CCW rotation around center point. Use negative angles to perform a CW rotation.

#### Return value

0        On success.  
1        On error.

### 6.5.9.1.6 GUI\_SVG\_DrawScaledRotatedEx()

#### Description

Draws a given SVG file from external memory at a given position with a given scaling factor.

#### Prototype

```
int GUI_SVG_DrawScaledRotatedEx(GUI_SVG_GET_DATA_FUNC * pfGetData,
                               void * p,
                               float x,
                               float y,
                               float Scale,
                               float Angle);
```

#### Parameters

Parameter	Description
<code>pfGetData</code>	<b>in</b> Function pointer to a GetData function. For more details, please refer to the chapter <i>FileAccess</i> on page 3219.
<code>p</code>	<b>in</b> User-defined pointer passed to <code>pfGetData</code> .
<code>x</code>	X-position to draw SVG in current window.
<code>y</code>	Y-position to draw SVG in current window.
<code>Scale</code>	Scaling factor used for X and Y.

#### Return value

0        On success.  
1        On error.

### 6.5.9.1.7 GUI\_SVG\_GetInfo()

#### Description

Fills an information structure from a file in accessible memory.

#### Prototype

```
int GUI_SVG_GetInfo(const void      * pFile,  
                   U32             FileSize,  
                   GUI_SVG_INFO * pInfo);
```

#### Parameters

Parameter	Description
<code>pFile</code>	<b>in</b> Pointer to a SVG file in binary form.
<code>FileSize</code>	Byte size of the array pointed to by <code>pFile</code> .
<code>pInfo</code>	<b>out</b> Pointer to a <code>GUI_SVG_INFO</code> structure to be filled with information about the SVG file.

#### Return value

0        On success.  
1        On error.

### 6.5.9.1.8 GUI\_SVG\_GetInfoEx()

#### Description

Fills an information structure from a file in non-accessible memory.

#### Prototype

```
int GUI_SVG_GetInfoEx(GUI_SVG_GET_DATA_FUNC * pfGetData,  
                    void * p,  
                    GUI_SVG_INFO * pInfo);
```

#### Parameters

Parameter	Description
<code>pfGetData</code>	<b>in</b> Function pointer to a GetData function. For more details, please refer to the chapter <i>FileAccess</i> on page 3219.
<code>p</code>	<b>in</b> User-defined pointer passed to <code>pfGetData</code> .
<code>pInfo</code>	<b>out</b> Pointer to a GUI_SVG_INFO structure to be filled with information about the SVG file.

#### Return value

0 On success.  
1 On error.

## 6.5.9.2 Handle-related routines

### 6.5.9.2.1 GUI\_SVG\_Create()

#### Description

Creates an SVG handle from a file located in addressable memory.

#### Prototype

```
GUI_SVG_Handle GUI_SVG_Create(const void * pFile,  
                             U32      FileSize);
```

#### Parameters

Parameter	Description
<code>pFile</code>	<b>in</b> Pointer to a SVG file in binary form.
<code>FileSize</code>	Byte size of the array pointed to by <code>pFile</code> .

#### Return value

Handle to an SVG object.

### 6.5.9.2.2 GUI\_SVG\_CreateEx()

#### Description

Creates an SVG handle from a file in external memory.

#### Prototype

```
GUI_SVG_Handle GUI_SVG_CreateEx(GUI_SVG_GET_DATA_FUNC * pfGetData,  
                                void * p);
```

#### Parameters

Parameter	Description
<code>pfGetData</code>	<b>in</b> Function pointer to a GetData function. For more details, please refer to the chapter <i>FileAccess</i> on page 3219.
<code>p</code>	<b>in</b> User-defined pointer passed to <code>pfGetData</code> .

#### Return value

Handle to an SVG object.



### 6.5.9.2.3 GUI\_SVG\_Delete()

#### Description

Deletes an SVG handle.

#### Prototype

```
void GUI_SVG_Delete(GUI_SVG_Handle hSVG);
```

#### Parameters

Parameter	Description
<a href="#">hSVG</a>	Handle to an SVG object.

### 6.5.9.2.4 GUI\_SVG\_DrawH()

#### Description

Renders an SVG file at the given position. The currently set affine transformation matrix is used for transformation.

#### Prototype

```
int GUI_SVG_DrawH(GUI_SVG_Handle hSVG,  
                 float          x,  
                 float          y);
```

#### Parameters

Parameter	Description
<a href="#">hSVG</a>	Handle to an SVG object.
<a href="#">x</a>	X-position in client coordinates.
<a href="#">y</a>	Y-position in client coordinates.

#### Return value

0        On success.  
1        On error.

#### Additional information

Note that the given position ([x,y](#)) is only used within the scope of this function. The affine transformation matrix is not translated using these values.

### 6.5.9.2.5 GUI\_SVG\_EnableCacheMode()

#### Description

Enables or disables caching mode for this SVG handle.

Caching mode will render the SVG into an internal memory device every time one of the SVG parameters is changed (e.g. transformations, background color changed, ...).

When `GUI_SVG_DrawH()` is called, the bitmap will be rendered if required and then the bitmap will be drawn.

#### Prototype

```
void GUI_SVG_EnableCacheMode(GUI_SVG_Handle hSVG,  
                             int Enable);
```

#### Parameters

Parameter	Description
<code>hSVG</code>	Handle to an SVG object.
<code>Enable</code>	1 for enabling cache mode, 0 for disabling.

#### Additional information

**Note:** Caching mode requires the Memory Devices add-on.

### 6.5.9.2.6 GUI\_SVG\_GetInfoH()

#### Description

Fills an information structure from an SVG handle.

#### Prototype

```
int GUI_SVG_GetInfoH(GUI_SVG_Handle  hSVG,  
                    GUI_SVG_INFO  * pInfo);
```

#### Parameters

Parameter	Description
<code>hSVG</code>	Handle to an SVG object.
<code>pInfo</code>	<code>out</code> Pointer to a <code>GUI_SVG_INFO</code> structure to be filled with information about the SVG file.

#### Return value

- 0        On success.
- 1        On error.

### 6.5.9.2.7 GUI\_SVG\_Identity()

#### Description

Resets the matrices related to the SVG object to the identity matrix. In other words, this clears everything previously set by any of the following routines:

- GUI\_SVG\_Translate()
- GUI\_SVG\_Scale()
- GUI\_SVG\_ScaleEx()
- GUI\_SVG\_Rotate()
- GUI\_SVG\_RotateEx()
- GUI\_SVG\_Transform()

#### Prototype

```
void GUI_SVG_Identity(GUI_SVG_Handle hSVG);
```

#### Parameters

Parameter	Description
<a href="#">hSVG</a>	Handle to an SVG object.

### 6.5.9.2.8 GUI\_SVG\_Render()

#### Description

Renders the SVG into the internal memory device.

It is optional to call this function, since a call of `GUI_SVG_DrawH()` will also render the memory device cache again if it's invalid. With this function the rendering can be abstracted from the draw function.

#### Prototype

```
int GUI_SVG_Render(GUI_SVG_Handle hSVG);
```

#### Parameters

Parameter	Description
<code>hSVG</code>	Handle to an SVG object.

#### Return value

- 0 On success.
- 1 Rendering failed due to not enough RAM being available for the internal memory device.
- 2 Invalid handle `hSVG`.

#### Additional information

This function only has an effect when caching mode has been enabled for this SVG handle with `GUI_SVG_EnableCacheMode()`.

### 6.5.9.2.9 GUI\_SVG\_Rotate()

#### Description

Sets the counter-clockwise rotation angle for rotations around the center point.

The rotation parameters will be used when drawing the SVG with `GUI_SVG_DrawH()`.

A negative angle can be passed to perform a clockwise rotation.

#### Prototype

```
void GUI_SVG_Rotate(GUI_SVG_Handle hSVG,  
                   float Angle);
```

#### Parameters

Parameter	Description
<code>hSVG</code>	Handle to an SVG object.
<code>Angle</code>	Rotation angle in degrees. If positive the rotation is CCW, if negative the rotation is CW.

### 6.5.9.2.10 GUI\_SVG\_RotateEx()

#### Description

Sets the counter-clockwise rotation angle for rotations around any given point.

The rotation parameters will be used when drawing the SVG with `GUI_SVG_DrawH()`.

A negative angle can be passed to perform a clockwise rotation.

#### Prototype

```
void GUI_SVG_RotateEx(GUI_SVG_Handle hSVG,  
                     float           Angle,  
                     float           x,  
                     float           y);
```

#### Parameters

Parameter	Description
<code>hSVG</code>	Handle to an SVG object.
<code>Angle</code>	Rotation angle in degrees. If positive the rotation is CCW, if negative the rotation is CW.
<code>x</code>	X position of the rotation point in unscaled viewport coordinates.
<code>y</code>	Y position of the rotation point in unscaled viewport coordinates.



### 6.5.9.2.11 GUI\_SVG\_Scale()

#### Description

Sets scaling factors in the X and Y direction that will be used when drawing an SVG with `GUI_SVG_DrawH()`.

By default the scaling will be done around the origin point. To set a point other than the origin point to perform the scaling around, use `GUI_SVG_ScaleEx()`.

#### Prototype

```
void GUI_SVG_Scale(GUI_SVG_Handle hSVG,  
                  float           xScale,  
                  float           yScale);
```

#### Parameters

Parameter	Description
<code>hSVG</code>	Handle to an SVG object.
<code>xScale</code>	Scaling factor in X (1.0F = 100%).
<code>yScale</code>	Scaling factor in Y (1.0F = 100%).

### 6.5.9.2.12 GUI\_SVG\_ScaleToSize()

#### Description

Sets the scaling factors so that the SVG is draw in the dimensions `xSize` and `ySize` when `GUI_SVG_DrawH()` is called.

The scaling is performed around the origin point of the SVG (0,0).

#### Prototype

```
void GUI_SVG_ScaleToSize(GUI_SVG_Handle hSVG,  
                        float           xSize,  
                        float           ySize);
```

#### Parameters

Parameter	Description
<code>hSVG</code>	Handle to an SVG object.
<code>xSize</code>	Desired <code>xSize</code> of the SVG, in pixels. Can be left as 0 for uniform scaling based on given <code>ySize</code> .
<code>ySize</code>	Desired <code>ySize</code> of the SVG, in pixels. Can be left as 0 for uniform scaling based on given <code>xSize</code> .

### 6.5.9.2.13 GUI\_SVG\_SetBkColor()

#### Description

Sets a background color used for filling the internal cache bitmap.

#### Prototype

```
void GUI_SVG_SetBkColor(GUI_SVG_Handle hSVG,  
                        GUI_COLOR      BkColor);
```

#### Parameters

Parameter	Description
<code>hSVG</code>	Handle to an SVG object.
<code>BkColor</code>	Background fill color.

#### Additional information

This function only has an effect when caching mode has been enabled for this SVG handle with `GUI_SVG_EnableCacheMode()`.

### 6.5.9.2.14 GUI\_SVG\_Transform()

#### Description

Sets a custom transformation matrix. The set matrix will be applied instead of the transformations set by `GUI_SVG_Scale()`, `GUI_SVG_Translate()` and `GUI_SVG_Rotate()`.

#### Prototype

```
void GUI_SVG_Transform(      GUI_SVG_Handle  hSVG,  
                           const GUI_MATRIX * pMatrix);
```

#### Parameters

Parameter	Description
<code>hSVG</code>	Handle to an SVG object.
<code>pMatrix</code>	<b>in</b> Pointer to a <code>GUI_MATRIX</code> structure, a copy of this matrix will be saved in the SVG object.

### 6.5.9.2.15 GUI\_SVG\_Translate()

#### Description

Sets the translation factors that will be used when drawing an SVG with `GUI_SVG_DrawH()`.

#### Prototype

```
void GUI_SVG_Translate(GUI_SVG_Handle hSVG,  
                      float          x,  
                      float          y);
```

#### Parameters

Parameter	Description
<code>hSVG</code>	Handle to an SVG object.
<code>x</code>	X-position of translation in LCD coordinates.
<code>y</code>	Y-position of translation in LCD coordinates.

## 6.5.9.3 SVG module related routines

### 6.5.9.3.1 GUI\_SVG\_Enable()

#### Description

Initializes or de-initializes the SVG module and the currently selected SVG driver.

It is optional to call this function before drawing SVGs.

It may be desirable to call this function beforehand, because otherwise the driver initialization takes place right before the first time an SVG is drawn. Based on the selected 2D vector API (e.g. OpenVG with OpenGL as the rendering backend), the initialization might take a bit longer.

#### Prototype

```
int GUI_SVG_Enable(int Enable);
```

#### Parameters

Parameter	Description
<code>Enable</code>	1 for enabling the SVG module, 0 for disabling.

#### Return value

= 0      On success.  
≠ 0      On error.

### 6.5.9.3.2 GUI\_SVG\_EnablePNG()

#### Description

Enables the drawing of PNGs that are embedded into SVGs.

#### Prototype

```
void GUI_SVG_EnablePNG(void);
```

#### Additional information

The PNG module can also be activated during compile-time by defining the macro `GUI_SVG_ENABLE_PNG`.

### 6.5.9.3.3 GUI\_SVG\_EnableJPEG()

#### Description

Enables the drawing of JPEGs that are embedded into SVGs.

#### Prototype

```
void GUI_SVG_EnableJPEG(void);
```

#### Additional information

The JPEG module can also be activated during compile-time by defining the macro `GUI_SVG_ENABLE_JPEG`.



#### 6.5.9.3.4 GUI\_SVG\_EnableGIF()

##### Description

Enables the drawing of GIFs that are embedded into SVGs.

##### Prototype

```
void GUI_SVG_EnableGIF(void);
```

##### Additional information

The GIF module can also be activated during compile-time by defining the macro `GUI_SVG_ENABLE_GIF`.

### 6.5.9.3.5 GUI\_SVG\_EnableBMP()

#### Description

Enables the drawing of BMPs that are embedded into SVGs.

#### Prototype

```
void GUI_SVG_EnableBMP(void);
```

#### Additional information

The BMP module can also be activated during compile-time by defining the macro `GUI_SVG_ENABLE_BMP`.

### 6.5.9.3.6 GUI\_SVG\_SetDPI()

#### Description

Sets the DPI (dots per inch) value used for parsing and displaying SVGs. The default value is 90 DPI.

If units like **mm** (millimeters), **cm** (centimeters) or **in** (inches) are used, it may be desirable to modify the DPI value to manipulate the parameters that are calculated for drawing.

#### Prototype

```
unsigned GUI_SVG_SetDPI(unsigned NumDotsPerInch);
```

#### Parameters

Parameter	Description
<a href="#">NumDotsPerInch</a>	New DPI value.

#### Return value

Old DPI value.

### 6.5.9.3.7 GUI\_SVG\_SetFileBufferSize()

#### Description

Sets the byte size of the buffer that will be used when an SVG file is read from external memory.

#### Prototype

```
unsigned GUI_SVG_SetFileBufferSize(unsigned NumBytes);
```

#### Parameters

Parameter	Description
<code>NumBytes</code>	Byte size of the buffer. Default is 512 bytes. Allowed range is 16 bytes up to 1 MB, the input value will be adjusted to these limits if it doesn't match.

#### Return value

Old buffer size.

#### Additional information

If reading the SVG file from a file system or external memory is a bottleneck and the system has a lot of RAM, it makes sense to increase the size of this buffer. With a bigger buffer there will be lesser accesses to the file system or external memory.

## 6.5.9.4 SVG driver related routines

### 6.5.9.4.1 GUI\_SVG\_DRIVER\_BindAPI()

#### Description

Binds the required 2D vector API functions to the given SVG driver.

#### Prototype

```
void GUI_SVG_DRIVER_BindAPI(      GUI_SVG_DRIVER * pDriver,
                                const void      * pAPI);
```

#### Parameters

Parameter	Description
<code>pDriver</code>	<b>in</b> Pointer to SVG driver, has to be one the drivers listed under SVG drivers.
<code>pAPI</code>	<b>in</b> Pointer to an API struct, the type has to match the driver <code>pDriver</code> ; see below table.

#### Additional information

The use-case of this function is when an emWin library is used where the required routines of the 2D vector API were not compiled with.

#### Required type based on SVG driver

SVG driver ( <code>pDriver</code> )	API struct type ( <code>pAPI</code> )
GUI_SVG_DRIVER_OPENVG	GUI_SVG_OPENVG_API_STRUCT
GUI_SVG_DRIVER_VGLITE	GUI_SVG_VGLITE_API_STRUCT
GUI_SVG_DRIVER_NEMAVG	GUI_SVG_NEMAVG_API_STRUCT
GUI_SVG_DRIVER_NANOVG	GUI_SVG_NANOVG_API_STRUCT

### 6.5.9.4.2 GUI\_SVG\_DRIVER\_BindDynamicAPI()

#### Description

Dynamically loads and binds the required 2D vector API functions to the given SVG driver.

#### Prototype

```
void GUI_SVG_DRIVER_BindDynamicAPI(GUI_SVG_DRIVER      * pDriver,
                                   void                * pAPI,
                                   GUI_SVG_LOAD_API_CALLBACK * cbLoadFunction);
```

#### Parameters

Parameter	Description
<code>pDriver</code>	<b>in</b> Pointer to SVG driver, has to be one of the values defined under <code>GUI_SVG_DRIVER</code> .
<code>pAPI</code>	<b>in/out</b> Pointer to an API struct, the type has to match the currently selected driver; see table under <code>GUI_SVG_DRIVER_BindAPI()</code> .
<code>cbLoadFunction</code>	<b>in</b> Callback that loads a given API function and returns its address.

### 6.5.9.4.3 GUI\_SVG\_DRIVER\_GetSelected()

#### Description

Returns the currently selected SVG driver.

#### Prototype

```
GUI_SVG_DRIVER *GUI_SVG_DRIVER_GetSelected(void);
```

#### Return value

Currently selected SVG driver, is one of the values listed under GUI\_SVG\_DRIVER.

#### 6.5.9.4.4 GUI\_SVG\_DRIVER\_HasBoundAPI()

##### Description

Checks if the given SVG driver has bound API functions.

##### Prototype

```
int GUI_SVG_DRIVER_HasBoundAPI(GUI_SVG_DRIVER * pDriver);
```

##### Parameters

Parameter	Description
<code>pDriver</code>	<b>in</b> Pointer to SVG driver, has to be one of the values defined under GUI_SVG_DRIVER.

##### Return value

- 0 Driver has no bound API functions, it cannot function.
- 1 Driver has bound API functions, it can be used.



### 6.5.9.4.5 GUI\_SVG\_DRIVER\_Select()

#### Description

Selects a given driver for rendering SVGs. If a different driver is selected than the current one, the old one will be de-initialized and the new driver will be initialized.

#### Prototype

```
int GUI_SVG_DRIVER_Select(GUI_SVG_DRIVER * pDriver);
```

#### Parameters

Parameter	Description
<code>pDriver</code>	<b>in</b> Pointer to SVG driver, has to be one of the values defined under <code>GUI_SVG_DRIVER</code> . Can be <code>NULL</code> to clear the selection of the current driver.

#### Return value

- 0 New driver successfully selected.
- 1 Invalid parameters.
- 2 Initialization of new driver failed, driver selection cleared.
- 3 Driver selection cleared, no driver is selected.

### 6.5.9.4.6 GUI\_SVG\_DRIVER\_SetHooks()

#### Description

Sets the desired hooks functions to a given SVG driver.

#### Prototype

```
void GUI_SVG_DRIVER_SetHooks(          GUI_SVG_DRIVER * pDriver,  
                                const GUI_SVG_HOOKS * pHooks);
```

#### Parameters

Parameter	Description
<code>pDriver</code>	<b>in</b> Pointer to SVG driver, has to be one of the values defined under <code>GUI_SVG_DRIVER</code> .
<code>pHooks</code>	<b>in</b> Pointer to a <code>GUI_SVG_HOOKS</code> struct that contains pointers to the desired hook functions.

### 6.5.9.4.7 GUI\_SVG\_DRIVER\_SetVersion()

#### Description

Sets a desired API version to the given SVG driver. This has to be done before the driver has been initialized and before any API functions are bound.

#### Prototype

```
int GUI_SVG_DRIVER_SetVersion(GUI_SVG_DRIVER * pDriver,
                              U8           Major,
                              U8           Minor,
                              U8           Bugfix);
```

#### Parameters

Parameter	Description
<code>pDriver</code>	<b>in</b> Pointer to SVG driver, has to be one of the values defined under <code>GUI_SVG_DRIVER</code> .
<code>Major</code>	Minor version number of the API.
<code>Minor</code>	Minor version number of the API.
<code>Bugfix</code>	<code>Bugfix</code> version number of the API.

#### Return value

- = 0      On success.
- ≠ 1     On error, invalid parameter or driver is already initialized.

## 6.5.9.5 Data structures

### 6.5.9.5.1 GUI\_SVG\_BBOX

#### Description

Boundary box of an SVG based on the currently set parameters like position, scaling, rotation, etc.

#### Type definition

```
typedef struct {  
    float  xMin;  
    float  yMin;  
    float  xMax;  
    float  yMax;  
} GUI_SVG_BBOX;
```

#### Structure members

Member	Description
<code>xMin</code>	Minimum X position on the display in floating point coordinates.
<code>yMin</code>	Minimum Y position on the display in floating point coordinates.
<code>xMax</code>	Maximum X position on the display in floating point coordinates.
<code>yMax</code>	Maximum Y position on the display in floating point coordinates.

### 6.5.9.5.2 GUI\_SVG\_HOOKS

#### Description

Allows to hook in into various spots during the SVG drawing process.

Only the desired hooks need to be set. The hooks can be set with `GUI_SVG_SetHooks()`.

#### Type definition

```
typedef struct {
    U8    (* pfPreInitDriverHook) (void);

    U8    (* pfPostInitDriverHook)(void);

    void (* pfDeinitDriverHook)  (void);
    void (* pfSwitchBufferHook)  (void);
    void (* pfBeginDrawHook)     (void);
    void (* pfEndDrawHook)       (void);
} GUI_SVG_HOOKS;
```

#### Structure members

Member	Description
<code>pfPreInitDriverHook</code>	Called before the SVG driver is initialized. May return 1 on error to abort the driver initialization.
<code>pfPostInitDriverHook</code>	Called when the SVG driver initialization has finished. May return 1 on error to abort the driver initialization.
<code>pfDeinitDriverHook</code>	Called after the SVG driver has been de-initialized.
<code>pfSwitchBufferHook</code>	Called during the drawing process, after the drawing commands have been flushed.
<code>pfBeginDrawHook</code>	Called at the end of the initialization of the drawing process of an SVG.
<code>pfEndDrawHook</code>	Called once the SVG drawing process has finished.

### 6.5.9.5.3 GUI\_SVG\_INFO

#### Description

Information about an SVG document, generated by the `GUI_SVG_GetInfo...`( ) functions.

#### Type definition

```
typedef struct {
    GUI_SVG_VIEWBOX  ViewBox;
    GUI_SVG_BBOX     BBox;
    float            xSize;
    float            ySize;
} GUI_SVG_INFO;
```

#### Structure members

Member	Description
<code>ViewBox</code>	Viewbox of the SVG, defines the coordinate range.
<code>BBox</code>	Boundary box of the SVG, based on the currently set affine transformation matrix.
<code>xSize</code>	Viewport width of the SVG, defined by the "width" attribute in the <svg> tag.
<code>ySize</code>	Viewport height of the SVG, defined by the "height" attribute in the <svg> tag.

#### Additional information

In case the "width" and "height" attributes of the SVG are in any other unit than pixels, the dimensions will be converted into pixels internally. Therefore, the struct members Width and Height are always in pixels. The conversion from other units into pixels is done using the currently set DPI (see `GUI_SVG_SetDPI()`).

#### 6.5.9.5.4 GUI\_SVG\_VIEWBOX

##### Description

The SVG's view box, as it is defined by the `viewBox` attribute in the `<svg>` tag.

##### Type definition

```
typedef struct {  
    float x;  
    float y;  
    float xSize;  
    float ySize;  
} GUI_SVG_VIEWBOX;
```

##### Structure members

Member	Description
<code>x</code>	X position of the view box.
<code>y</code>	Y position of the view box.
<code>xSize</code>	Width of the view box.
<code>ySize</code>	Height of the view box.

### 6.5.9.5.5 GUI\_SVG\_EGL\_API\_STRUCT

#### Description

Maps the required EGL functions of the Khronos OpenVG API.

Using EGL is optional since some OpenVG implementations do not implement the EGL API.

#### Type definition

```
typedef struct {
    GUI_SVG_EGL_GETDISPLAY_FUNC          * pfGetDisplay;
    GUI_SVG_EGL_CREATEPIXMAPSURFACE_FUNC * pfCreatePixmapSurface;
    GUI_SVG_EGL_DESTROYSURFACE_FUNC      * pfDestroySurface;
    GUI_SVG_EGL_CREATECONTEXT_FUNC        * pfCreateContext;
    GUI_SVG_EGL_INITIALIZE_FUNC           * pfInitialize;
    GUI_SVG_EGL_BINDAPI_FUNC              * pfBindAPI;
    GUI_SVG_EGL_CHOOSECONFIG_FUNC         * pfChooseConfig;
    GUI_SVG_EGL_MAKECURRENT_FUNC          * pfMakeCurrent;
    GUI_SVG_EGL_GETERROR_FUNC             * pfGetError;
} GUI_SVG_EGL_API_STRUCT;
```

#### Structure members

Member	Description
<a href="#">pfGetDisplay</a>	Pointer to EGL function <code>eglGetDisplay()</code>
<a href="#">pfCreatePixmapSurface</a>	Pointer to EGL function <code>eglCreatePixmapSurface()</code>
<a href="#">pfDestroySurface</a>	Pointer to EGL function <code>eglDestroySurface()</code>
<a href="#">pfCreateContext</a>	Pointer to EGL function <code>eglCreateContext()</code>
<a href="#">pfInitialize</a>	Pointer to EGL function <code>eglInitialize()</code>
<a href="#">pfBindAPI</a>	Pointer to EGL function <code>eglBindAPI()</code>
<a href="#">pfChooseConfig</a>	Pointer to EGL function <code>eglChooseConfig()</code>
<a href="#">pfMakeCurrent</a>	Pointer to EGL function <code>eglMakeCurrent()</code>
<a href="#">pfGetError</a>	Pointer to EGL function <code>eglGetError()</code>



### 6.5.9.5.6 GUI\_SVG\_GL\_API\_STRUCT

#### Description

Maps the required OpenGL functions required for NanoVG.

For more details about these functions, please refer to the OpenGL API documentation.

#### Type definition

```
typedef struct {  
    GUI_SVG_GL_CLEAR_FUNC      * pfClear;  
    GUI_SVG_GL_READPIXELS_FUNC * pfReadPixels;  
} GUI_SVG_GL_API_STRUCT;
```

#### Structure members

Member	Description
<a href="#">pfClear</a>	Pointer to OpenGL function <code>glClear()</code> .
<a href="#">pfReadPixels</a>	Pointer to OpenGL function <code>glReadPixels()</code> .

### 6.5.9.5.7 GUI\_SVG\_NANOVG\_API\_STRUCT

#### Description

Maps the required functions of the NanoVG API.

A structure of this type can be set with `GUI_SVG_DRIVER_BindAPI()` when a precompiled `emWin` library is used, that was compiled without the NanoVG code (meaning `GUI_SVG_HAS_NANOVG` was not defined).

For more details about these functions, please refer to the NanoVG API documentation.

#### Type definition

```
typedef struct {
    GUI_SVG_GL_API_STRUCT           GL;
    GUI_SVG_NANOVG_BEGINFRAME_FUNC * pfBeginFrame;
    GUI_SVG_NANOVG_BEGINPATH_FUNC  * pfBeginPath;
    GUI_SVG_NANOVG_BEZIERTO_FUNC   * pfBezierTo;
    GUI_SVG_NANOVG_CLOSEPATH_FUNC  * pfClosePath;
    GUI_SVG_NANOVG_CREATE_FUNC     * pfCreate;
    GUI_SVG_NANOVG_CREATEIMAGERGBA_FUNC * pfCreateImageRGBA;
    GUI_SVG_NANOVG_DELETE_FUNC     * pfDelete;
    GUI_SVG_NANOVG_DELETEIMAGE_FUNC * pfDeleteImage;
    GUI_SVG_NANOVG_ENDFRAME_FUNC   * pfEndFrame;
    GUI_SVG_NANOVG_FILL_FUNC       * pfFill;
    GUI_SVG_NANOVG_FILLCOLOR_FUNC  * pfFillColor;
    GUI_SVG_NANOVG_FILLPAINT_FUNC  * pfFillPaint;
    GUI_SVG_NANOVG_GLOBALALPHA_FUNC * pfGlobalAlpha;
    GUI_SVG_NANOVG_IMAGEPATTERN_FUNC * pfImagePattern;
    GUI_SVG_NANOVG_LINECAP_FUNC    * pfLineCap;
    GUI_SVG_NANOVG_LINEJOIN_FUNC   * pfLineJoin;
    GUI_SVG_NANOVG_LINETO_FUNC     * pfLineTo;
    GUI_SVG_NANOVG_MITERLIMIT_FUNC * pfMiterLimit;
    GUI_SVG_NANOVG_MOVETO_FUNC     * pfMoveTo;
    GUI_SVG_NANOVG_PATHWINDING_FUNC * pfPathWinding;
    GUI_SVG_NANOVG_QUADTO_FUNC     * pfQuadTo;
    GUI_SVG_NANOVG_RECT_FUNC       * pfRect;
    GUI_SVG_NANOVG_RESETSCISSOR_FUNC * pfResetScissor;
    GUI_SVG_NANOVG_RESETTRANSFORM_FUNC * pfResetTransform;
    GUI_SVG_NANOVG_RGBA_FUNC       * pfRGBA;
    GUI_SVG_NANOVG_SCISSOR_FUNC    * pfScissor;
    GUI_SVG_NANOVG_SHAPEANTIALIAS_FUNC * pfShapeAntiAlias;
    GUI_SVG_NANOVG_STROKE_FUNC     * pfStroke;
    GUI_SVG_NANOVG_STROKECOLOR_FUNC * pfStrokeColor;
    GUI_SVG_NANOVG_STROKEWIDTH_FUNC * pfStrokeWidth;
    GUI_SVG_NANOVG_TRANSFORM_FUNC  * pfTransform;
} GUI_SVG_NANOVG_API_STRUCT;
```

#### Structure members

Member	Description
<code>GL</code>	Functions for OpenGL rendering backend.
<code>pfBeginFrame</code>	Pointer to NanoVG function ( <code>nvgBeginFrame</code> ).
<code>pfBeginPath</code>	Pointer to NanoVG function ( <code>nvgBeginPath</code> ).
<code>pfBezierTo</code>	Pointer to NanoVG function ( <code>nvgBezierTo</code> ).
<code>pfClosePath</code>	Pointer to NanoVG function ( <code>nvgClosePath</code> ).
<code>pfCreate</code>	Pointer to NanoVG function ( <code>nvgCreate</code> ).
<code>pfCreateImageRGBA</code>	Pointer to NanoVG function ( <code>nvgCreateImageRGB</code> ).
<code>pfDelete</code>	Pointer to NanoVG function ( <code>nvgDelete</code> ).
<code>pfDeleteImage</code>	Pointer to NanoVG function ( <code>nvgDeleteImage</code> ).
<code>pfEndFrame</code>	Pointer to NanoVG function ( <code>nvgEndFrame</code> ).

Member	Description
<a href="#">pfFill</a>	Pointer to NanoVG function ( <code>nvgFill</code> ).
<a href="#">pfFillColor</a>	Pointer to NanoVG function ( <code>nvgFillColor</code> ).
<a href="#">pfFillPaint</a>	Pointer to NanoVG function ( <code>nvgFillPaint</code> ).
<a href="#">pfGlobalAlpha</a>	Pointer to NanoVG function ( <code>nvgGlobalAlpha</code> ).
<a href="#">pfImagePattern</a>	Pointer to NanoVG function ( <code>nvgImagePattern</code> ).
<a href="#">pfLineCap</a>	Pointer to NanoVG function ( <code>nvgLineCap</code> ).
<a href="#">pfLineJoin</a>	Pointer to NanoVG function ( <code>nvgLineJoin</code> ).
<a href="#">pfLineTo</a>	Pointer to NanoVG function ( <code>nvgLineTo</code> ).
<a href="#">pfMiterLimit</a>	Pointer to NanoVG function ( <code>nvgMiterLimit</code> ).
<a href="#">pfMoveTo</a>	Pointer to NanoVG function ( <code>nvgMoveTo</code> ).
<a href="#">pfPathWinding</a>	Pointer to NanoVG function ( <code>nvgPathWinding</code> ).
<a href="#">pfQuadTo</a>	Pointer to NanoVG function ( <code>nvgQuadTo</code> ).
<a href="#">pfRect</a>	Pointer to NanoVG function ( <code>nvgRect</code> ).
<a href="#">pfResetScissor</a>	Pointer to NanoVG function ( <code>nvgResetScissor</code> ).
<a href="#">pfResetTransform</a>	Pointer to NanoVG function ( <code>nvgResetTransform</code> ).
<a href="#">pfRGBA</a>	Pointer to NanoVG function ( <code>nvgRGBA</code> ).
<a href="#">pfScissor</a>	Pointer to NanoVG function ( <code>nvgScissor</code> ).
<a href="#">pfShapeAntiAlias</a>	Pointer to NanoVG function ( <code>nvgShapeAntiAlias</code> ).
<a href="#">pfStroke</a>	Pointer to NanoVG function ( <code>nvgStroke</code> ).
<a href="#">pfStrokeColor</a>	Pointer to NanoVG function ( <code>nvgStrokeColor</code> ).
<a href="#">pfStrokeWidth</a>	Pointer to NanoVG function ( <code>nvgStrokeWidth</code> ).
<a href="#">pfTransform</a>	Pointer to NanoVG function ( <code>nvgTransform</code> ).

### 6.5.9.5.8 GUI\_SVG\_NEMAVG\_API\_STRUCT

#### Description

Maps the required functions of the ThinkSilicon NemaVG API.

A structure of this type can be set with `GUI_SVG_DRIVER_BindAPI()` when a precompiled `emWin` library is used, that was compiled without the NemaVG code (meaning `GUI_SVG_HAS_NEMAVG` was not defined).

For more details about these functions, please refer to the NemaVG API documentation.

#### Type definition

```
typedef struct {
    GUI_SVG_NEMAVG_INIT_FUNC          * pfInit;
    GUI_SVG_NEMAVG_SETCLIP_FUNC       * pfSetClip;
    GUI_SVG_NEMAVG_BINDDSTTEX_FUNC    * pfBindDstTex;
    GUI_SVG_NEMAVG_CLCREATESTEX_FUNC  * pfClCreateSized;
    GUI_SVG_NEMAVG_CLBINDCIRCULAR_FUNC * pfClBindCircular;
    GUI_SVG_NEMAVG_CLSUBMIT_FUNC       * pfClSubmit;
    GUI_SVG_NEMAVG_CLWAIT_FUNC         * pfClWait;
    GUI_SVG_NEMAVG_CLREWIND_FUNC       * pfClRewind;
    GUI_SVG_NEMAVG_CLDESTROY_FUNC      * pfClDestroy;
    GUI_SVG_NEMAVG_VGINIT_FUNC         * pfVgInit;
    GUI_SVG_NEMAVG_VGDEINIT_FUNC       * pfVgDeinit;
    GUI_SVG_NEMAVG_HANDLELARGECOORDS_FUNC * pfVgHandleLargeCoords;
    GUI_SVG_NEMAVG_SETBLEND_FUNC       * pfVgSetBlend;
    GUI_SVG_NEMAVG_SETFILLRULE_FUNC    * pfVgSetFillRule;
    GUI_SVG_NEMAVG_SETQUALITY_FUNC     * pfVgSetQuality;
    GUI_SVG_NEMAVG_DRAWPATH_FUNC       * pfVgDrawPath;
    GUI_SVG_NEMAVG_DRAWRECT_FUNC       * pfVgDrawRect;
    GUI_SVG_NEMAVG_PATHCREATE_FUNC     * pfVgPathCreate;
    GUI_SVG_NEMAVG_PATHSETMATRIX_FUNC  * pfVgPathSetMatrix;
    GUI_SVG_NEMAVG_PATHSETSHAPE_FUNC   * pfVgPathSetShape;
    GUI_SVG_NEMAVG_PATHDESTROY_FUNC    * pfVgPathDestroy;
    GUI_SVG_NEMAVG_GRADCREATE_FUNC     * pfVgGradCreate;
    GUI_SVG_NEMAVG_GRADSET_FUNC        * pfVgGradSet;
    GUI_SVG_NEMAVG_GRADDESTROY_FUNC    * pfVgGradDestroy;
    GUI_SVG_NEMAVG_PAINTCREATE_FUNC     * pfVgPaintCreate;
    GUI_SVG_NEMAVG_PAINTSETTYPE_FUNC    * pfVgPaintSetType;
    GUI_SVG_NEMAVG_PAINTSETGRADLINEAR_FUNC * pfVgPaintSetGradLinear;
    GUI_SVG_NEMAVG_PAINTSETGRADRADIAL2_FUNC * pfVgPaintSetGradRadial2;
    GUI_SVG_NEMAVG_PAINTSETOPACITY_FUNC * pfVgPaintSetOpacity;
    GUI_SVG_NEMAVG_PAINTSETPAINTCOLOR_FUNC * pfVgPaintSetPaintColor;
    GUI_SVG_NEMAVG_PAINTSETSTROKEWIDTH_FUNC * pfVgPaintSetStrokeWidth;
    GUI_SVG_NEMAVG_PAINTSETTEX_FUNC     * pfVgPaintSetTex;
    GUI_SVG_NEMAVG_PAINTSETTEXMATRIX_FUNC * pfVgPaintSetTexMatrix;
    GUI_SVG_NEMAVG_PAINTDESTROY_FUNC    * pfVgPaintDestroy;
    GUI_SVG_NEMAVG_STROKESETCAPSTYLE_FUNC * pfVgStrokeSetCapStyle;
    GUI_SVG_NEMAVG_STROKESETJOINSTYLE_FUNC * pfVgStrokeSetJoinStyle;
    GUI_SVG_NEMAVG_STROKESETMITERLIMIT_FUNC * pfVgStrokeSetMiterLimit;
} GUI_SVG_NEMAVG_API_STRUCT;
```

#### Structure members

Member	Description
<a href="#">pfInit</a>	Pointer to NemaVG function <code>nema_init()</code>
<a href="#">pfSetClip</a>	Pointer to NemaVG function <code>nema_set_clip()</code>
<a href="#">pfBindDstTex</a>	Pointer to NemaVG function <code>nema_bind_dst_tex()</code>
<a href="#">pfClCreateSized</a>	Pointer to NemaVG function <code>nema_cl_create_sized()</code>
<a href="#">pfClBindCircular</a>	Pointer to NemaVG function <code>nema_cl_bind_circular()</code>

Member	Description
<a href="#">pfClSubmit</a>	Pointer to NemaVG function <code>nema_cl_submit()</code>
<a href="#">pfClWait</a>	Pointer to NemaVG function <code>nema_cl_wait()</code>
<a href="#">pfClRewind</a>	Pointer to NemaVG function <code>nema_cl_rewind()</code>
<a href="#">pfClDestroy</a>	Pointer to NemaVG function <code>nema_cl_destroy()</code>
<a href="#">pfVgInit</a>	Pointer to NemaVG function <code>nema_vg_init()</code>
<a href="#">pfVgDeinit</a>	Pointer to NemaVG function <code>nema_vg_deinit()</code>
<a href="#">pfVgHandleLargeCoords</a>	Pointer to NemaVG function <code>nema_vg_handle_large_coords()</code>
<a href="#">pfVgSetBlend</a>	Pointer to NemaVG function <code>nema_vg_set_blend()</code>
<a href="#">pfVgSetFillRule</a>	Pointer to NemaVG function <code>nema_vg_set_fill_rule()</code>
<a href="#">pfVgSetQuality</a>	Pointer to NemaVG function <code>nema_vg_set_quality()</code>
<a href="#">pfVgDrawPath</a>	Pointer to NemaVG function <code>nema_vg_draw_path()</code>
<a href="#">pfVgDrawRect</a>	Pointer to NemaVG function <code>nema_vg_draw_rect()</code>
<a href="#">pfVgPathCreate</a>	Pointer to NemaVG function <code>nema_vg_path_create()</code>
<a href="#">pfVgPathSetMatrix</a>	Pointer to NemaVG function <code>nema_vg_path_set_matrix()</code>
<a href="#">pfVgPathSetShape</a>	Pointer to NemaVG function <code>nema_vg_path_set_shape()</code>
<a href="#">pfVgPathDestroy</a>	Pointer to NemaVG function <code>nema_vg_path_destroy()</code>
<a href="#">pfVgGradCreate</a>	Pointer to NemaVG function <code>nema_vg_grad_create()</code>
<a href="#">pfVgGradSet</a>	Pointer to NemaVG function <code>nema_vg_grad_set()</code>
<a href="#">pfVgGradDestroy</a>	Pointer to NemaVG function <code>nema_vg_grad_destroy()</code>
<a href="#">pfVgPaintCreate</a>	Pointer to NemaVG function <code>nema_vg_paint_create()</code>
<a href="#">pfVgPaintSetType</a>	Pointer to NemaVG function <code>nema_vg_paint_set_type()</code>
<a href="#">pfVgPaintSetGradLinear</a>	Pointer to NemaVG function <code>nema_vg_paint_set_grad_linear()</code>
<a href="#">pfVgPaintSetGradRadial2</a>	Pointer to NemaVG function <code>nema_vg_paint_set_grad_radial2()</code>
<a href="#">pfVgPaintSetOpacity</a>	Pointer to NemaVG function <code>nema_vg_paint_set_opacity()</code>
<a href="#">pfVgPaintSetPaintColor</a>	Pointer to NemaVG function <code>nema_vg_paint_set_paint_color()</code>
<a href="#">pfVgPaintSetStrokeWidth</a>	Pointer to NemaVG function <code>nema_vg_paint_set_stroke_width()</code>
<a href="#">pfVgPaintSetTex</a>	Pointer to NemaVG function <code>nema_vg_paint_set_tex()</code>
<a href="#">pfVgPaintSetTexMatrix</a>	Pointer to NemaVG function <code>nema_vg_paint_set_tex_matrix()</code>
<a href="#">pfVgPaintDestroy</a>	Pointer to NemaVG function <code>nema_vg_paint_destroy()</code>

Member	Description
<a href="#">pfVgStrokeSetCapStyle</a>	Pointer to NemaVG function <code>nema_vg_stroke_set_cap_style()</code>
<a href="#">pfVgStrokeSetJoinStyle</a>	Pointer to NemaVG function <code>nema_vg_stroke_set_join_style()</code>
<a href="#">pfVgStrokeSetMiterLimit</a>	Pointer to NemaVG function <code>nema_vg_stroke_set_miter_limit()</code>

### 6.5.9.5.9 GUI\_SVG\_OPENVG\_API\_STRUCT

#### Description

Maps the required functions of the Khronos OpenVG API.

A structure of this type can be set with `GUI_SVG_DRIVER_BindAPI()` when a precompiled `emWin` library is used, that was compiled without the OpenVG code (meaning `GUI_SVG_HAS_OPENVG` and `GUI_SVG_HAS_EGL` were not defined).

For more details about these functions, please refer to the OpenVG API documentation.

#### Type definition

```
typedef struct {
    GUI_SVG_OPENVG_LOADMATRIX_FUNC * pfLoadMatrix;
    GUI_SVG_OPENVG_GETMATRIX_FUNC * pfGetMatrix;
    GUI_SVG_OPENVG_CREATEPATH_FUNC * pfCreatePath;
    GUI_SVG_OPENVG_DESTROYPATH_FUNC * pfDestroyPath;
    GUI_SVG_OPENVG_CREATEIMAGE_FUNC * pfCreateImage;
    GUI_SVG_OPENVG_DESTROYIMAGE_FUNC * pfDestroyImage;
    GUI_SVG_OPENVG_DRAWIMAGE_FUNC * pfDrawImage;
    GUI_SVG_OPENVG_IMAGESUBDATA_FUNC * pfImageSubData;
    GUI_SVG_OPENVG_APPENDPATHDATA_FUNC * pfAppendPathData;
    GUI_SVG_OPENVG_DRAWPATH_FUNC * pfDrawPath;
    GUI_SVG_OPENVG_CREATEPAINT_FUNC * pfCreatePaint;
    GUI_SVG_OPENVG_SETPAINT_FUNC * pfSetPaint;
    GUI_SVG_OPENVG_DESTROYPAINT_FUNC * pfDestroyPaint;
    GUI_SVG_OPENVG_FLUSH_FUNC * pfFlush;
    GUI_SVG_OPENVG_FINISH_FUNC * pfFinish;
    GUI_SVG_OPENVG_WRITEPIXELS_FUNC * pfWritePixels;
    GUI_SVG_OPENVG_READPIXELS_FUNC * pfReadPixels;
    GUI_SVG_OPENVG_SETF_FUNC * pfSetF;
    GUI_SVG_OPENVG_SETI_FUNC * pfSetI;
    GUI_SVG_OPENVG_SETFV_FUNC * pfSetFV;
    GUI_SVG_OPENVG_SETIV_FUNC * pfSetIV;
    GUI_SVG_OPENVG_GETF_FUNC * pfGetF;
    GUI_SVG_OPENVG_GETI_FUNC * pfGetI;
    GUI_SVG_OPENVG_GETFV_FUNC * pfGetFV;
    GUI_SVG_OPENVG_GETIV_FUNC * pfGetIV;
    GUI_SVG_OPENVG_SETPARAMETERF_FUNC * pfSetParameterF;
    GUI_SVG_OPENVG_SETPARAMETERI_FUNC * pfSetParameterI;
    GUI_SVG_OPENVG_SETPARAMETERFV_FUNC * pfSetParameterFV;
    GUI_SVG_OPENVG_SETPARAMETERIV_FUNC * pfSetParameterIV;
    GUI_SVG_OPENVG_GETPARAMETERF_FUNC * pfGetParameterF;
    GUI_SVG_OPENVG_GETPARAMETERI_FUNC * pfGetParameterI;
    GUI_SVG_OPENVG_GETPARAMETERFV_FUNC * pfGetParameterFV;
    GUI_SVG_OPENVG_GETPARAMETERIV_FUNC * pfGetParameterIV;
    const GUI_SVG_EGL_API_STRUCT * pEGL;
} GUI_SVG_OPENVG_API_STRUCT;
```

#### Structure members

Member	Description
<a href="#">pfLoadMatrix</a>	Pointer to OpenVG function <code>vgLoadMatrix()</code>
<a href="#">pfGetMatrix</a>	Pointer to OpenVG function <code>vgGetMatrix()</code>
<a href="#">pfCreatePath</a>	Pointer to OpenVG function <code>vgCreatePath()</code>
<a href="#">pfDestroyPath</a>	Pointer to OpenVG function <code>vgDestroyPath()</code>
<a href="#">pfCreateImage</a>	Pointer to OpenVG function <code>vgCreateImage()</code>
<a href="#">pfDestroyImage</a>	Pointer to OpenVG function <code>vgDestroyImage()</code>
<a href="#">pfDrawImage</a>	Pointer to OpenVG function <code>vgDrawImage()</code>
<a href="#">pfImageSubData</a>	Pointer to OpenVG function <code>vgImageSubData()</code>
<a href="#">pfAppendPathData</a>	Pointer to OpenVG function <code>vgAppendPathData()</code>

Member	Description
<a href="#">pfDrawPath</a>	Pointer to OpenVG function <code>vgDrawPath()</code>
<a href="#">pfCreatePaint</a>	Pointer to OpenVG function <code>vgCreatePaint()</code>
<a href="#">pfSetPaint</a>	Pointer to OpenVG function <code>vgSetPaint()</code>
<a href="#">pfDestroyPaint</a>	Pointer to OpenVG function <code>vgDestroyPaint()</code>
<a href="#">pfFlush</a>	Pointer to OpenVG function <code>vgFlush()</code>
<a href="#">pfFinish</a>	Pointer to OpenVG function <code>vgFinish()</code>
<a href="#">pfWritePixels</a>	Pointer to OpenVG function <code>vgWritePixels()</code>
<a href="#">pfReadPixels</a>	Pointer to OpenVG function <code>vgReadPixels()</code>
<a href="#">pfSetF</a>	Pointer to OpenVG function <code>vgSetf()</code>
<a href="#">pfSetI</a>	Pointer to OpenVG function <code>vgSeti()</code>
<a href="#">pfSetFV</a>	Pointer to OpenVG function <code>vgSetfv()</code>
<a href="#">pfSetIV</a>	Pointer to OpenVG function <code>vgSetiv()</code>
<a href="#">pfGetF</a>	Pointer to OpenVG function <code>vgGetf()</code>
<a href="#">pfGetI</a>	Pointer to OpenVG function <code>vgGeti()</code>
<a href="#">pfGetFV</a>	Pointer to OpenVG function <code>vgGetfv()</code>
<a href="#">pfGetIV</a>	Pointer to OpenVG function <code>vgGetiv()</code>
<a href="#">pfSetParameterF</a>	Pointer to OpenVG function <code>vgSetParameterf()</code>
<a href="#">pfSetParameterI</a>	Pointer to OpenVG function <code>vgSetParameteri()</code>
<a href="#">pfSetParameterFV</a>	Pointer to OpenVG function <code>vgSetParameterfv()</code>
<a href="#">pfSetParameterIV</a>	Pointer to OpenVG function <code>vgSetParameteriv()</code>
<a href="#">pfGetParameterF</a>	Pointer to OpenVG function <code>vgGetParameterf()</code>
<a href="#">pfGetParameterI</a>	Pointer to OpenVG function <code>vgGetParameteri()</code>
<a href="#">pfGetParameterFV</a>	Pointer to OpenVG function <code>vgGetParameterfv()</code>
<a href="#">pfGetParameterIV</a>	Pointer to OpenVG function <code>vgGetParameteriv()</code>
<a href="#">pEGL</a>	Pointer to a <code>GUI_SVG_EGL_API_STRUCT</code> structure. May be <code>NULL</code> if EGL is not to be used.



### 6.5.9.5.10 GUI\_SVG\_VGLITE\_API\_STRUCT

#### Description

Maps the required functions of the Vivante VGLite API.

A structure of this type can be set with `GUI_SVG_DRIVER_BindAPI()` when a precompiled `emWin` library is used, that was compiled without the VGLite code (meaning `GUI_SVG_HAS_VGLITE` was not defined).

For more details about what each function does, please refer to the VGLite API documentation.

#### Type definition

```
typedef struct {
    GUI_SVG_VGLITE_BLIT_FUNC          * pFBlit;
    GUI_SVG_VGLITE_DRAWPATH_FUNC     * pFDrawPath;
    GUI_SVG_VGLITE_INITPATH_FUNC     * pFInitPath;
    GUI_SVG_VGLITE_INITPATH_FUNC     * pFInitArcPath;
    GUI_SVG_VGLITE_CLEARPATH_FUNC    * pFClearPath;
    GUI_SVG_VGLITE_SETPATHDRAWTYPE_FUNC * pFSetDrawPathType;
    GUI_SVG_VGLITE_SETSTROKE_FUNC    * pFSetStroke;
    GUI_SVG_VGLITE_UPDATESTROKE_FUNC * pFUpdateStroke;
    GUI_SVG_VGLITE_SETLINGRAD_FUNC   * pFSetLinGrad;
    GUI_SVG_VGLITE_UPDATELINGRAD_FUNC * pFUpdateLinGrad;
    GUI_SVG_VGLITE_GETLINGRADMATRIX_FUNC * pFGetLinGradMatrix;
    GUI_SVG_VGLITE_DRAWLINGRAD_FUNC  * pFDrawLinGrad;
    GUI_SVG_VGLITE_CLEARLINGRAD_FUNC * pFClearLinGrad;
    GUI_SVG_VGLITE_SETRADGRAD_FUNC   * pFSetRadGrad;
    GUI_SVG_VGLITE_UPDATERADGRAD_FUNC * pFUpdateRadGrad;
    GUI_SVG_VGLITE_GETRADGRADMATRIX_FUNC * pFGetRadGradMatrix;
    GUI_SVG_VGLITE_DRAWRADGRAD_FUNC  * pFDrawRadGrad;
    GUI_SVG_VGLITE_CLEARRADGRAD_FUNC * pFClearRadGrad;
    GUI_SVG_VGLITE_ENABLESCISSOR_FUNC * pFEnableScissor;
    GUI_SVG_VGLITE_DISABLESCISSOR_FUNC * pFDisableScissor;
    GUI_SVG_VGLITE_SETSCISSOR_FUNC   * pFSetScissor;
    GUI_SVG_VGLITE_FLUSH_FUNC        * pFFlush;
    GUI_SVG_VGLITE_FINISH_FUNC       * pFFinish;
    GUI_SVG_VGLITE_QUERY_FEATURE_FUNC * pFQueryFeature;
} GUI_SVG_VGLITE_API_STRUCT;
```

#### Structure members

Member	Description
<a href="#">pFBlit</a>	Pointer to VGLite function <code>vg_lite_blit()</code>
<a href="#">pFDrawPath</a>	Pointer to VGLite function <code>vg_lite_draw()</code>
<a href="#">pFInitPath</a>	Pointer to VGLite function <code>vg_lite_init_path()</code>
<a href="#">pFInitArcPath</a>	Pointer to VGLite function <code>vg_lite_init_arc_path()</code>
<a href="#">pFClearPath</a>	Pointer to VGLite function <code>vg_lite_clear_path()</code>
<a href="#">pFSetDrawPathType</a>	Pointer to VGLite function <code>vg_lite_set_draw_path_type()</code>
<a href="#">pFSetStroke</a>	Pointer to VGLite function <code>vg_lite_set_stroke()</code>
<a href="#">pFUpdateStroke</a>	Pointer to VGLite function <code>vg_lite_update_stroke()</code>
<a href="#">pFSetLinGrad</a>	Pointer to VGLite function <code>vg_lite_set_linear_grad()</code>
<a href="#">pFUpdateLinGrad</a>	Pointer to VGLite function <code>vg_lite_update_linear_grad()</code>
<a href="#">pFGetLinGradMatrix</a>	Pointer to VGLite function <code>vg_lite_get_linear_grad_matrix()</code>
<a href="#">pFDrawLinGrad</a>	Pointer to VGLite function <code>vg_lite_draw_linear_gradient()</code>
<a href="#">pFClearLinGrad</a>	Pointer to VGLite function <code>vg_lite_clear_linear_grad()</code>

Member	Description
<a href="#">pfSetRadGrad</a>	Pointer to VGLite function <code>vg_lite_set_rad_grad()</code>
<a href="#">pfUpdateRadGrad</a>	Pointer to VGLite function <code>vg_lite_update_rad_grad()</code>
<a href="#">pfGetRadGradMatrix</a>	Pointer to VGLite function <code>vg_lite_get_rad_grad_matrix()</code>
<a href="#">pfDrawRadGrad</a>	Pointer to VGLite function <code>vg_lite_draw_radial_gradient()</code>
<a href="#">pfClearRadGrad</a>	Pointer to VGLite function <code>vg_lite_clear_rad_grad()</code>
<a href="#">pfEnableScissor</a>	Pointer to VGLite function <code>vg_lite_enable_scissor()</code>
<a href="#">pfDisableScissor</a>	Pointer to VGLite function <code>vg_lite_disable_scissor()</code>
<a href="#">pfSetScissor</a>	Pointer to VGLite function <code>vg_lite_set_scissor()</code>
<a href="#">pfFlush</a>	Pointer to VGLite function <code>vg_lite_flush()</code>
<a href="#">pfFinish</a>	Pointer to VGLite function <code>vg_lite_finish()</code>
<a href="#">pfQueryFeature</a>	Pointer to VGLite function <code>vg_lite_query_feature()</code>

## 6.5.9.6 Prototypes

### 6.5.9.6.1 GUI\_SVG\_GET\_DATA\_FUNC

#### Description

GetData function used for the SVG format, for more details see [GUI\\_GET\\_DATA\\_FUNC\\_II](#).

#### Type definition

```
typedef GUI_GET_DATA_FUNC_II GUI_SVG_GET_DATA_FUNC;
```

### 6.5.9.6.2 GUI\_SVG\_LOAD\_API\_CALLBACK

#### Description

Callback used to load a given routine. The callback receives the name of the routine to be loaded as a string and should return its address as a void function pointer.

The main use case of this callback is to load a function from a DLL.

#### Type definition

```
typedef void (* GUI_SVG_LOAD_API_CALLBACK(const char * sFunction);
```

#### Parameters

Parameter	Description
<code>sFunction</code>	<b>in</b> Name of the routine to be loaded as a zero-terminated string.

#### Return value

Address of the function casted to a void function pointer.

## 6.5.9.7 Defines

### 6.5.9.7.1 GUI\_SVG\_DECLARE\_EGL\_API

#### Description

Macro to define a structure of the type `GUI_SVG_EGL_API_STRUCT` filled with the correct function pointers.

#### Definition

```
#define GUI_SVG_DECLARE_EGL_API(VAR_NAME) \
    static const GUI_SVG_EGL_API_STRUCT VAR_NAME = { \
        eglGetDisplay, \
        eglCreatePixmapSurface, \
        eglDestroySurface, \
        eglCreateContext, \
        eglInitialize, \
        eglBindAPI, \
        eglChooseConfig, \
        eglMakeCurrent, \
        eglGetError, \
    }
```

#### Parameters

Parameter	Description
<code>VAR_NAME</code>	Identifier name to be used for the structure variable.

### 6.5.9.7.2 GUI\_SVG\_DECLARE\_NANOVG\_API

#### Parameters

Parameter	Description
VAR_NAME	Identifier name to be used for the structure variable.

### 6.5.9.7.3 GUI\_SVG\_DECLARE\_NEMAVG\_API

#### Description

Macro to define a structure of the type GUI\_SVG\_NEMAVG\_API\_STRUCT filled with the correct function pointers.

#### Definition

```
#define GUI_SVG_DECLARE_NEMAVG_API(VAR_NAME) \
    static const GUI_SVG_NEMAVG_API_STRUCT VAR_NAME = { \
        nema_init, \
        nema_set_clip, \
        nema_bind_dst_tex, \
        nema_cl_create_sized, \
        nema_cl_bind_circular, \
        nema_cl_submit, \
        nema_cl_wait, \
        nema_cl_rewind, \
        nema_cl_destroy, \
        nema_vg_init, \
        (GUI_SVG_NEMAVG_VGDEINIT_FUNC *)nema_vg_deinit, \
        nema_vg_handle_large_coords, \
        nema_vg_set_blend, \
        nema_vg_set_fill_rule, \
        nema_vg_set_quality, \
        nema_vg_draw_path, \
        nema_vg_draw_rect, \
        (GUI_SVG_NEMAVG_PATHCREATE_FUNC *)nema_vg_path_create, \
        nema_vg_path_set_matrix, \
        nema_vg_path_set_shape, \
        nema_vg_path_destroy, \
        nema_vg_grad_create, \
        nema_vg_grad_set, \
        nema_vg_grad_destroy, \
        (GUI_SVG_NEMAVG_PAINTCREATE_FUNC *)nema_vg_paint_create, \
        nema_vg_paint_set_type, \
        nema_vg_paint_set_grad_linear, \
        nema_vg_paint_set_grad_radial2, \
        nema_vg_paint_set_opacity, \
        nema_vg_paint_set_paint_color, \
        nema_vg_paint_set_stroke_width, \
        nema_vg_paint_set_tex, \
        nema_vg_paint_set_tex_matrix, \
        nema_vg_paint_destroy, \
        NEMA_VG_FUNCTIONS_1_1_7 \
    }
```

#### Parameters

Parameter	Description
<code>VAR_NAME</code>	Identifier name to be used for the structure variable.

### 6.5.9.7.4 GUI\_SVG\_DECLARE\_OPENVG\_API

#### Description

Macro to define a structure of the type `GUI_SVG_OPENVG_API_STRUCT` filled with the correct function pointers.

#### Definition

```
#define GUI_SVG_DECLARE_OPENVG_API(VAR_NAME, EGL_PTR) \
    static const GUI_SVG_OPENVG_API_STRUCT VAR_NAME = { \
        vgLoadMatrix, \
        vgGetMatrix, \
        vgCreatePath, \
        vgDestroyPath, \
        vgCreateImage, \
        vgDestroyImage, \
        vgDrawImage, \
        vgImageSubData, \
        vgAppendPathData, \
        vgDrawPath, \
        vgCreatePaint, \
        vgSetPaint, \
        vgDestroyPaint, \
        vgFlush, \
        vgFinish, \
        vgWritePixels, \
        vgReadPixels, \
        vgSetf, \
        vgSeti, \
        vgSetfv, \
        vgSetiv, \
        vgGetf, \
        vgGeti, \
        vgGetfv, \
        vgGetiv, \
        vgSetParameterf, \
        vgSetParameteri, \
        vgSetParameterfv, \
        vgSetParameteriv, \
        vgGetParameterf, \
        vgGetParameteri, \
        vgGetParameterfv, \
        vgGetParameteriv, \
        EGL_PTR, \
    }
```

#### Parameters

Parameter	Description
<code>VAR_NAME</code>	Identifier name to be used for the structure variable.
<code>EGL_PTR</code>	Optional pointer to <code>GUI_SVG_EGL_API_STRUCT</code> if EGL API should be used. If not, it must be left as <code>NULL</code> .



### 6.5.9.7.5 GUI\_SVG\_DECLARE\_OPENVG\_AND\_EGL\_API

#### Description

Macro to define a structure of the type `GUI_SVG_OPENVG_API_STRUCT` filled with the correct function pointers as well as a pointer to a `GUI_SVG_EGL_API_STRUCT` structure.

#### Definition

```
#define GUI_SVG_DECLARE_OPENVG_AND_EGL_API(VAR_NAME)    \  
    GUI_SVG_DECLARE_EGL_API(_EGL);                    \  
    GUI_SVG_DECLARE_OPENVG_API(VAR_NAME, &_EGL)
```

#### Parameters

Parameter	Description
<code>VAR_NAME</code>	Identifier name to be used for the structure variable.

### 6.5.9.7.6 GUI\_SVG\_DECLARE\_VGLITE\_API

#### Description

Macro to define a structure of the type `GUI_SVG_VGLITE_API_STRUCT` filled with the correct function pointers.

#### Definition

```
#define GUI_SVG_DECLARE_VGLITE_API(VAR_NAME) \
    static const GUI_SVG_VGLITE_API_STRUCT VAR_NAME = { \
    vg_lite_blit, \
    vg_lite_draw, \
    vg_lite_init_path, \
    vg_lite_init_arc_path, \
    vg_lite_clear_path, \
    vg_lite_set_draw_path_type, \
    vg_lite_set_stroke, \
    vg_lite_update_stroke, \
    vg_lite_set_linear_grad, \
    vg_lite_update_linear_grad, \
    vg_lite_get_linear_grad_matrix, \
    vg_lite_draw_linear_gradient, \
    vg_lite_clear_linear_grad, \
    vg_lite_set_rad_grad, \
    vg_lite_update_rad_grad, \
    vg_lite_get_rad_grad_matrix, \
    vg_lite_draw_radial_gradient, \
    vg_lite_clear_rad_grad, \
    vg_lite_enable_scissor, \
    vg_lite_disable_scissor, \
    vg_lite_set_scissor, \
    vg_lite_flush, \
    vg_lite_finish, \
    vg_lite_query_feature, \
    }
```

#### Parameters

Parameter	Description
<code>VAR_NAME</code>	Identifier name to be used for the structure variable.

### 6.5.9.7.7 GUI\_SVG\_DRIVER

#### Description

All available SVG drivers for run-time usage with the GUI\_SVG\_DRIVER\_... routines.

#### Definition

```
#define GUI_SVG_DRIVER_OPENVG      (&GUI_SVG_DRIVER_OpenVG)
#define GUI_SVG_DRIVER_VGLITE     (&GUI_SVG_DRIVER_VGLite)
#define GUI_SVG_DRIVER_NEMAVG     (&GUI_SVG_DRIVER_NemaVG)
#define GUI_SVG_DRIVER_NANOVG     (&GUI_SVG_DRIVER_NanoVG)
```

#### Symbols

Definition	Description
<a href="#">GUI_SVG_DRIVER_OPENVG</a>	SVG driver for OpenVG API.
<a href="#">GUI_SVG_DRIVER_VGLITE</a>	SVG driver for VGLite API.
<a href="#">GUI_SVG_DRIVER_NEMAVG</a>	SVG driver for NemaVG API.
<a href="#">GUI_SVG_DRIVER_NANOVG</a>	SVG driver for NanoVG API.

## 6.6 Colors

emWin supports color displays, grayscale (monochrome with different intensities) and black/white displays. An existing emWin application can be used with different kinds of displays. If an existing application should be used with a new display only the display configuration (normally located in `LCDConf.c`) needs to be changed. To achieve this the application uses 'logical colors'. That logical color format is independent of the color (or better pixel-) format required for the display controller.



## 6.6.1 Color management

If an application uses a color for a drawing operation that color normally should be a 'logical color' containing 8 bits for each color channel and 8 bits for the alpha channel. The display controller normally requires a different format, called 'index value' in this document. 'Logical colors' are independent of the used hardware. The format of the 'index values' depend on the requirements of the display controller. Wherever emWin draws anything on the display it converts the 'logical color' used by the application into an 'index value' for the controller. That conversion is done automatically by the color conversion routines configured in the display configuration routine `LCD_X_Config()` which should set up the routines to be used. That could be done separately for each layer.

emWin supports different ways of color conversion:

### Fixed palette mode

Using a fixed palette mode is the most recommended way of color conversion. It sets up conversion routines for converting a color into an index value and vice versa. emWin provides a large set of predefined fixed palette modes explained later in this chapter.

### Application defined color conversion

If none of the predefined fixed palette modes match the requirements a custom color conversion could be used. That simply means custom defined routines for converting a color into an index value and vice versa. Details explained later in this chapter.

### Custom palette mode

If a display controller with a palette based color management is used, either one of the fixed palette modes could be used or a custom palette could be defined.

In case of using a custom palette emWin converts the logical colors by using an optimized version of the "least-square deviation search". It compares the color to display (the logical color) with all the available palette colors and uses the one that the LCD-metric considers closest. Please note that using a custom palette mode could degrade the performance. Details about how to use a custom palette explained later in this chapter.

## 6.6.2 Logical colors

A logical color contains 8 bits for each color component and 8 bits for the alpha channel. Since V5.30 emWin supports 2 logical color formats:

### Logical color format ABGR

Alpha	Blue	Green	Red
0x00 - opaque 0xFF - transparent			
DB31 - DB24	DB23 - DB16	DB15 - DB08	DB07 - DB00

For a long period of time the above format was the only supported logical color format. That implies that the used logical color format of all applications using emWin written within that period is also the same.

### Logical color format ARGB (default)

Alpha	Red	Green	Blue
0x00 - transparent 0xFF - opaque			
DB31 - DB24	DB23 - DB16	DB15 - DB08	DB07 - DB00

Because of more and more hardware platforms using a slightly different pixel format we decided to add the option of using ARGB as logical color format to be able to improve performance significantly under certain circumstances. Please note that the alpha definition of the ARGB format is also different to the ABGR format.

This format is the default setting since version 5.48 of emWin. To use the ABGR format add the following to your GUIConf.h:

```
#define GUI_USE_ARGB 0
```

## 6.6.3 Switching to ARGB

Using that logical color format could make sense if a display controller is used which supports exactly that color format as index value. In that case the performance could be improved significantly, for example when using an on chip LCD controller with hardware acceleration.

### 6.6.3.1 Configuration

In previous versions of emWin it was required to configure emWin to use the ARGB format. Since version 5.48 this format is the default and no changes to the GUIConf.h are required any longer.

Under certain circumstances it might be necessary to switch back to the old configuration. If this is necessary just add the following to your GUIConf.h:

```
#define GUI_USE_ARGB 0
```

### 6.6.3.2 Required changes in existing applications

When switching from ABGR to ARGB or vice versa some things have to be considered.

#### Colors

Wherever colors are defined as hexadecimal values in the application the values have to be changed or even better a conversion macro has to be used. The following table shows the use of the same color with ARGB, ABGR and conversion macro:

File	Description
ARGB	GUI_SetColor(0xA02010);
ABGR	GUI_SetColor(0xFF1020A0);
Conversion macro	GUI_SetColor(GUI_MAKE_COLOR(0xFF1020A0));

Of course all predefined color values will be changed automatically.

#### 32 bpp Memory devices

emWin contains a couple of functions to be used with 32 bpp memory devices only. Those functions expect a determined memory device format. When working in ABGR mode that format is GUICC\_8888. When switching to ARGB that format is GUICC\_M8888I.

#### DIB bitmaps

Palette based bitmaps created by the bitmap converter contains an array of palette colors. Example:

```
static GUI_CONST_STORAGE GUI_COLOR _Colors8x1[] = {
    0x000000, 0xC04040, 0x40C020, 0xC0A000,
    0x4020E0, 0xC040A0, 0x00FFFF, 0xFFFFFFFF
};
```

All existing bitmaps need to be changed:

```
static GUI_CONST_STORAGE GUI_COLOR _Colors8x1[] = {
    0xFF000000, 0xFF4040C0, 0xFF20C040, 0xFF00A0C0,
    0xFFE02040, 0xFFA040C0, 0xFFFFFFFF00, 0xFFFFFFFF
};
```

If an application contains a large number of bitmaps a better way would be to convert the bitmaps again with new settings for the bitmap converter.

### 6.6.3.3 Configuring the BitmapConverter

In order to configure the bitmap converter to save colors directly in ARGB instead of ABGR the option available under **Options** → **Save colors in ARGB mode** should be activated.

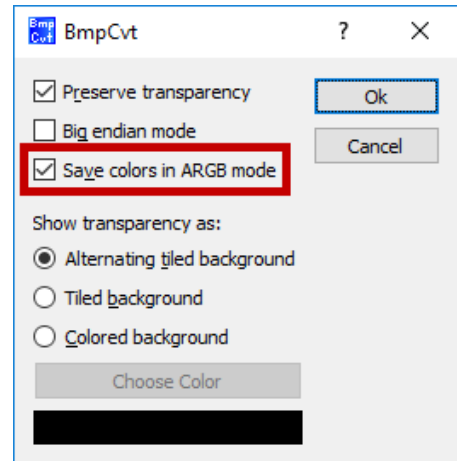



## 6.6.4 Predefined colors

In addition to self-defined colors, some standard colors are predefined in emWin, as shown in the following table:

GUI_BLUE		0xFF0000
GUI_GREEN		0x00FF00
GUI_RED		0x0000FF
GUI_CYAN		0xFFFF00
GUI_MAGENTA		0xFF00FF
GUI_YELLOW		0x00FFFF
GUI_LIGHTBLUE		0xFF8080
GUI_LIGHTGREEN		0x80FF80
GUI_LIGHTRED		0x8080FF
GUI_LIGHTCYAN		0xFFFF80
GUI_LIGHTMAGENTA		0xFF80FF
GUI_LIGHTYELLOW		0x80FFFF
GUI_DARKBLUE		0x800000
GUI_DARKGREEN		0x008000
GUI_DARKRED		0x000080
GUI_DARKCYAN		0x808000
GUI_DARKMAGENTA		0x800080
GUI_DARKYELLOW		0x008080
GUI_WHITE		0xFFFFFFFF
GUI_LIGHTGRAY		0xD3D3D3
GUI_GRAY		0x808080
GUI_DARKGRAY		0x404040
GUI_BLACK		0x000000
GUI_BROWN		0x2A2AA5
GUI_ORANGE		0x00A5FF

### Example

```
/* Set background color to magenta */
GUI_SetBkColor(GUI_MAGENTA);
GUI_Clear();
```

## 6.6.5 The color bar test routine

The color bar example program is used to show 13 color bars in the following order:

1. Black → Red
2. White → Red
3. Black → Green
4. White → Green
5. Black → Blue
6. White → Blue
7. Black → White
8. Black → Yellow
9. White → Yellow
10. Black → Cyan
11. White → Cyan
12. Black → Magenta
13. White → Magenta

This simple routine may be used on all displays in any color format. Of course, the results vary depending on the colors that can be displayed; the routine requires a display size of 320 \* 240 in order to show all colors. The routine is used to demonstrate the effect of the different color settings for displays. It may also be used by a test program to verify the functionality of the display, to check available colors and grayscales, as well as to correct color conversion. The screenshots are taken from the windows simulation and will look exactly like the actual output on your display if your settings and hardware are working properly. The routine is available as `COLOR_ShowColorBar.c` in the examples shipped with emWin.

## 6.6.6 Fixed palette modes

The following table lists the available fixed palette color modes and the necessary identifiers which need to be used when creating a driver- or a Memory Device. Detailed descriptions follow.

Identifier	No. available colors	Mask
GUICC_1	black and white	0x01 -> 00000001
GUICC_2	4 grayscales	0x03 -> 00000011
GUICC_4	16 grayscales	0x0F -> 00001111
GUICC_5	32 grayscales	0x1F -> 00011111
GUICC_16	16	0x0F -> 00001111
GUICC_1616I	16 + 4 bit alpha blending	0xFF -> 11111111
GUICC_111	8	0x07 -> 00000BGR
GUICC_M111	8	0x07 -> 00000RGB
GUICC_222	64	0x3F -> 00BBGGRR
GUICC_M222	64	0x3F -> 00RRGGBB
GUICC_M2222I	64	0x3F -> AARRGGBB
GUICC_8	256 grayscales	0xFF -> 11111111
GUICC_233	256	0xFF -> BBGGRRRR
GUICC_M233	256	0xFF -> RRGGBBBB
GUICC_323	256	0xFF -> BBBGGRRR
GUICC_M323	256	0xFF -> RRRGGBBB
GUICC_332	256	0xFF -> BBBGGGRR
GUICC_M332	256	0xFF -> RRRGGGBB
GUICC_444_12	4096	0x0FFF -> 0000BBBBGGGRRRRR
GUICC_M444_12	4096	0x0FFF -> 0000RRRRGGGGBBBB
GUICC_444_12_1	4096	0xFFFF0 -> BBBBGGGRRRR0000
GUICC_444_16	4096	0x7BDE -> 0BBBB0GGG0RRRR0
GUICC_M444_16	4096	0x7BDE -> 0RRRR0GGG0BBBB0
GUICC_M4444I	4096 + 4 bit alpha blending	0xFFFF -> AAAARRRRGGGGBBBB
GUICC_555	32768	0x7FFF -> 0BBBBGGGGRRRRR
GUICC_M555	32768	0x7FFF -> 0RRRRGGGGGBBBB
GUICC_M1555I	32768 + 1 bit transparency	0xFFFF -> TRRRRRGGGGGBBBB
GUICC_565	65536	0xFFFF -> BBBBGGGGRRRRR
GUICC_M565	65536	0xFFFF -> RRRRGGGGGGBBBB
GUICC_666	262144	0x0003FFFF -> BBBBGGGGRRRRR
GUICC_M666	262144	0x0003FFFF -> RRRRRGGGGGBBBB
GUICC_666_9	262144	0x01FF01FF -> 000000BBBBBGGG000000GGGRRRRR
GUICC_M666_9	262144	0x01FF01FF -> 000000RRRRRGGG000000GGGBBBB
GUICC_666_18	262144	0x00FCFCFC -> 0000000BBBBB0GGGGG00RRRRR00
GUICC_M666_18	262144	0x00FCFCFC -> 0000000RRRRR0GGGGG00BBBBB00
GUICC_822216	256	0xFF - Bits are not explicitly assigned to a color.

Identifier	No. available colors	Mask
GUICC_84444	240	0xFF - Bits are not explicitly assigned to a color.
GUICC_8666	232	0xFF - Bits are not explicitly assigned to a color.
GUICC_8666_1	233 (232 + transparency)	0xFF - Bits are not explicitly assigned to a color.
GUICC_88666I	232 + 8 bits alpha blending	0xFFFF -> AAAAAAACCCCCC
GUICC_888	16M	0x0FFFFFFF -> BBBBGGGGRRRR
GUICC_M888	16M	0x0FFFFFFF -> RRRRRGGGGBBBBB
GUICC_8888	16M + 8 bit alpha blending	0xFFFFFFFF -> AAAAAABBBBGGGGRRRR
GUICC_8888I	16M + 8 bit alpha blending	0xFFFFFFFF -> AAAAAABBBBGGGGRRRR
GUICC_M8888	16M + 8 bit alpha blending	0xFFFFFFFF -> AAAAAARRRRRRGGGGBBBBB
GUICC_M8888I	16M + 8 bit alpha blending	0xFFFFFFFF -> AAAAAARRRRRRGGGGBBBBB
GUICC_0	-	CUSTOM DEFINED FIXED PALETTE MODE
GUICC_1_2 GUICC_1_4 GUICC_1_5 GUICC_1_8 GUICC_1_16 GUICC_1_24	2 (black and white)	0x0000001 0x0000003 0x000001F 0x00000FF 0x0000FFFF 0x00FFFFFF

### Legend

**R** - Red  
**G** - Green  
**B** - Blue  
**C** - Color (in case of no explicit bit assignment to colors)  
**T** - Transparency bit  
**A** - Alpha mask

### 6.6.7 Detailed fixed palette mode description

The following gives a detailed description of the available colors in each predefined fixed palette mode.

#### 6.6.7.1 GUICC\_1: 1 bpp (black and white)

Use of this mode is necessary for monochrome displays with 1 bit per pixel.

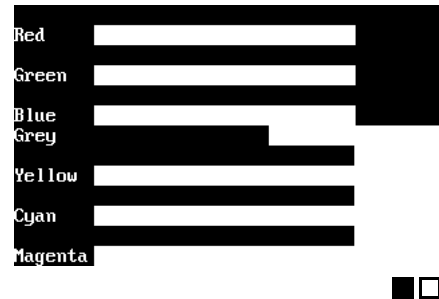

Available colors: 2

#### 6.6.7.2 GUICC\_2: 2 bpp (4 grayscales)

Use of this mode is necessary for monochrome displays with 2 bits per pixel.

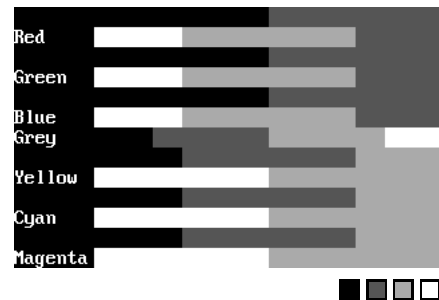

Available colors: 2 × 2 = 4

#### 6.6.7.3 GUICC\_4: 4 bpp (16 grayscales)

Use of this mode is necessary for monochrome displays with 4 bits per pixel.

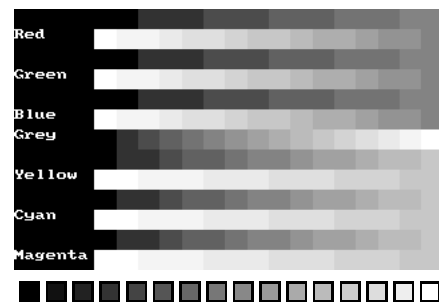

Available colors: 2 × 2 × 2 × 2 = 16

#### 6.6.7.4 GUICC\_5: 5 bpp (32 grayscales)

Use of this mode is necessary for monochrome displays with 5 bits per pixel.

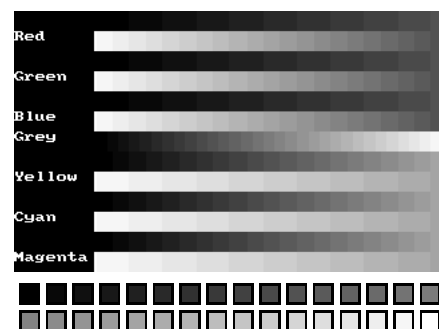

Available colors: 2 × 2 × 2 × 2 × 2 = 32

### 6.6.7.5 GUICC\_111: 3 bpp (2 levels per color)

Use this mode if the basic 8 colors are enough, if your hardware supports only one bit per pixel and color or if you do not have sufficient video memory for a higher color depth.



Available colors:  $2 \times 2 \times 2 = 8$   
Color mask: BGR

### 6.6.7.6 GUICC\_M111: 3 bpp (2 levels per color), red and blue swapped

Use this mode if the basic 8 colors are enough, if your hardware supports only one bit per pixel and color or if you do not have sufficient video memory for a higher color depth. The available colors are the same as those in 111 mode.

Available colors:  $2 \times 2 \times 2 = 8$   
Color mask: RGB

### 6.6.7.7 GUICC\_16: 4 bpp (16 colors)

This mode can be used if the basic 16 colors are enough, if the hardware supports only 4 bits per pixel or if you do not have sufficient video memory for a higher color depth.

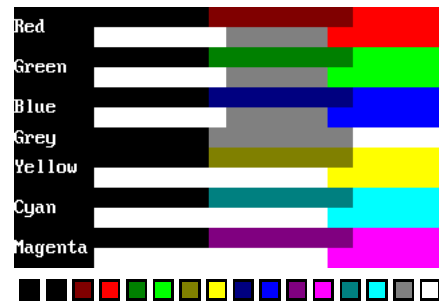

Available colors:  $2 \times 2 \times 2 \times 2 = 16$

### 6.6.7.8 GUICC\_1616I: 8 bpp (16 colors + 4 bits alpha mask)

Same colors as in GUICC\_16. The lower 4 bits contain the color and the upper 4 bits are used for alpha blending.

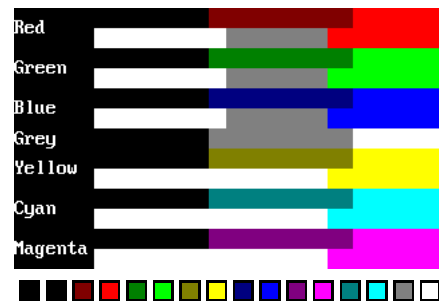

Available colors:  $2 \times 2 \times 2 \times 2 = 16$   
Color mask: AAAACCCC  
(AAAA = 0xF - opaque)  
(AAAA = 0x0 - transparent)

### 6.6.7.9 GUICC\_222: 6 bpp (4 levels per color)

This mode is a good choice if your hardware does not have a palette for every individual color. 2 bits per pixel and color are reserved; usually 1 byte is used to store one pixel.



Available colors:  $4 \times 4 \times 4 = 64$

Color mask: BBGGRR

### 6.6.7.10 GUICC\_M222: 6 bpp (4 levels per color), red and blue swapped

This mode is a good choice if your hardware does not have a palette for every individual color. 2 bits per pixel and color are reserved; usually 1 byte is used to store one pixel. The available colors are the same as those in 222 mode.

Available colors:  $4 \times 4 \times 4 = 64$



Color mask: RRGGBB

### 6.6.7.11 GUICC\_M2222I: 6 bpp (4 levels per color) + 2 bit alpha, red and blue swapped

This mode was introduced for the GUIDRV\_S1D13C00 display driver. It has a 6 bit color depths but uses the remaining 2 bits as alpha channel.

Available colors:  $4 \times 4 \times 4 = 64$



Color mask: AARRGGBB  
(AA = 0xC0 - opaque)  
(AA = 0x00 - transparent)

### 6.6.7.12 GUICC\_8: 8 bpp (256 greyscales)

This mode uses 8 bpp for greyscales only. This is the smoothes possible grayscale mode.

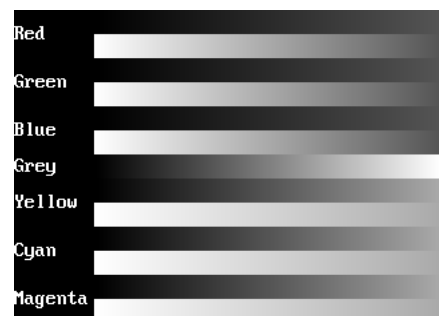

Available colors: 256 shades of gray.

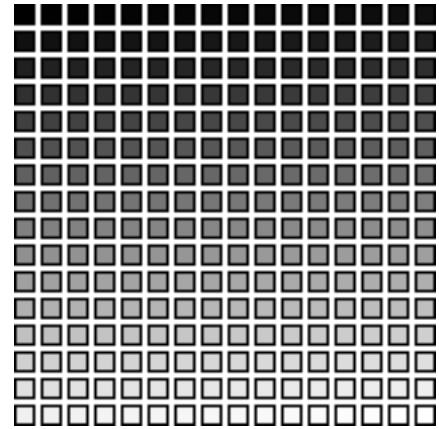

### 6.6.7.13 GUICC\_233: 8 bpp

This mode supports 256 colors. 3 bits are used for the red and green components of the color and 2 bits for the blue component. As shown in the picture, the result is 8 grades for green and red and 4 grades for blue. We discourage the use of this mode because it do not contain real shades of gray.



Available colors:  $4 \times 8 \times 8 = 256$

Color mask: BBGGRRR

### 6.6.7.14 GUICC\_M233: 8 bpp, red and blue swapped

This mode supports 256 colors. 3 bits are used for the red and green components of the color and 2 bits for the blue component. The result is 8 grades for green and blue and 4 grades for red. We discourage the use of this mode because it do not contain real shades of gray.

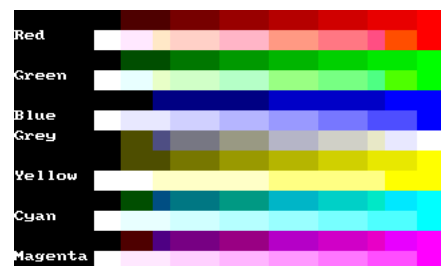



Available colors:  $4 \times 8 \times 8 = 256$

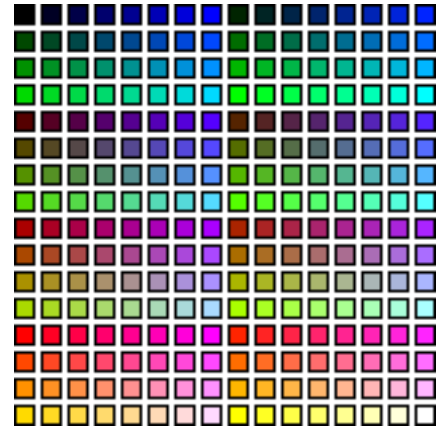

Color mask: RRGGBBBB

### 6.6.7.15 GUICC\_323: 8 bpp

This mode supports 256 colors. 3 bits are used for the red and blue components of the color and 2 bits for the green component. As shown in the picture, the result is 8 grades for blue and red and 4 grades for green. We discourage the use of this mode because it do not contain real shades of gray.

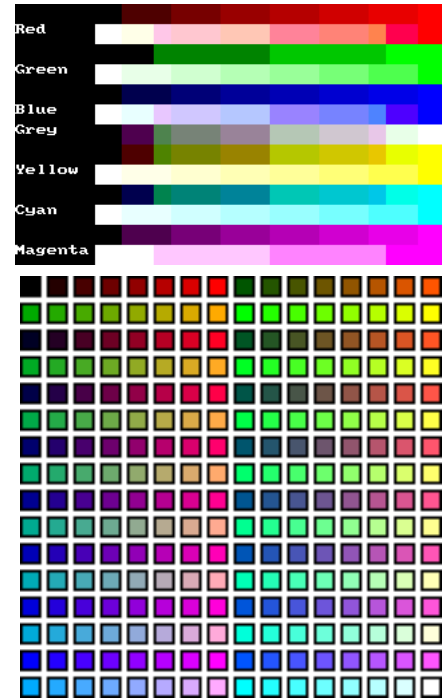

Available colors:  $8 \times 4 \times 8 = 256$

Color mask: BBBGRRR

### 6.6.7.16 GUICC\_M323: 8 bpp, red and blue swapped

This mode supports 256 colors. 3 bits are used for the red and blue components of the color and 2 bits for the green component. The available colors are the same as those in 323 mode. The result is 8 grades for red and blue and 4 grades for green. We discourage the use of this mode because it do not contain real shades of gray.

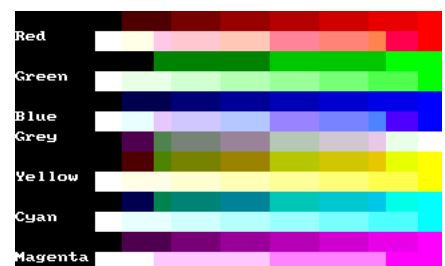

Available colors:  $8 \times 4 \times 8 = 256$

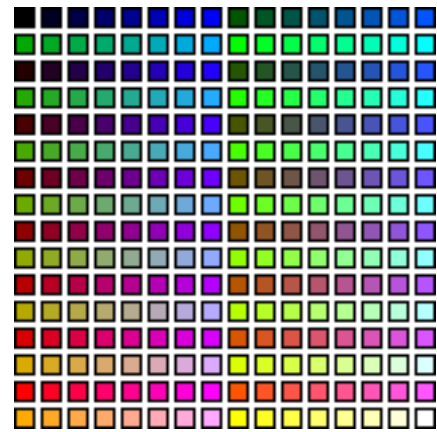

Color mask: RRRGGBBB

### 6.6.7.17 GUICC\_332: 8 bpp

This mode supports 256 colors. 3 bits are used for the blue and green components of the color and 2 bits for the red component. As shown in the picture, the result is 8 grades for green and blue and 4 grades for red. We discourage the use of this mode because it do not contain real shades of gray.

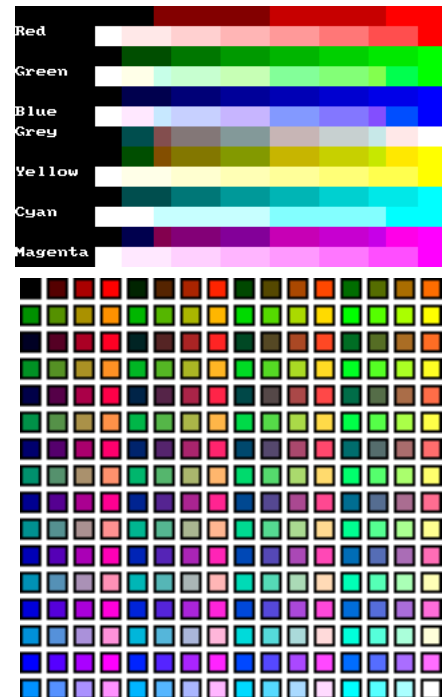

Available colors:  $8 \times 8 \times 4 = 256$

Color mask: BBBGGRR

### 6.6.7.18 GUICC\_M332: 8 bpp, red and blue swapped

This mode supports 256 colors. 3 bits are used for the red and green components of the color and 2 bits for the blue component. The result is 8 grades for red and green and only 4 grades for blue. We discourage the use of this mode because it do not contain real shades of gray.

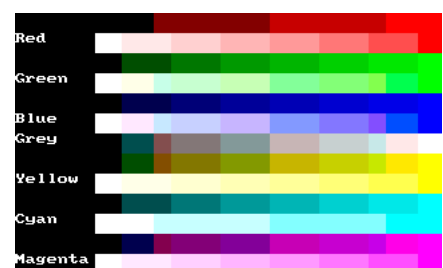

Available colors:  $8 \times 8 \times 4 = 256$

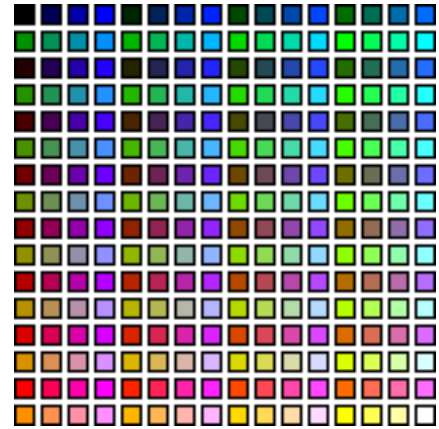

Color mask: RRRGGGBB

### 6.6.7.19 GUICC\_444\_12

The red, green and blue components are each 4 bits.



Available colors:  $16 \times 16 \times 16 = 4096$

Color mask: 0000BBBBGGGGRRRR

### 6.6.7.20 GUICC\_444\_16

The red, green and blue components are each 4 bits. One bit between the color components is not used. The available colors are the same as those in 444\_12 mode.



Available colors:  $16 \times 16 \times 16 = 4096$

Color mask: 0BBBB0GGGG0RRRR0

### 6.6.7.21 GUICC\_M444\_12: red and blue swapped

The red, green and blue components are each 4 bits. The available colors are the same as those in 444\_12 mode.

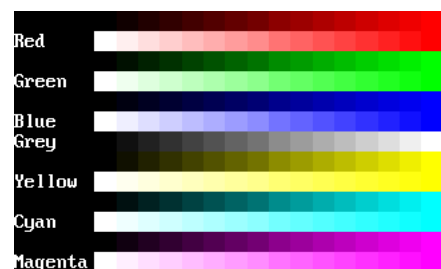

Available colors:  $16 \times 16 \times 16 = 4096$

Color mask: RRRRGGGGBBBB

### 6.6.7.22 GUICC\_M444\_16: red and blue swapped

The red, green and blue components are each 4 bits. One bit between the color components is not used. The available colors are the same as those in 444\_12 mode.

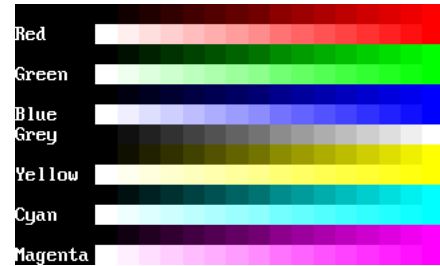

Available colors:  $16 \times 16 \times 16 = 4096$

Color mask: 0RRRR0GGGG0BBBB0

### 6.6.7.23 GUICC\_M444\_12\_1

The red, green and blue components are each 4 bits. The lower 4 bits of the color mask are not used. The available colors are the same as those in 444\_12 mode.



Available colors:  $16 \times 16 \times 16 = 4096$

Color mask: BBBBGGGGRRRR0000

### 6.6.7.24 GUICC\_M4444I: 12 bits colors + 4 bits alpha mask

The red, green and blue components are each 4 bits, the upper 4 bits are used for alpha blending.



Available colors:  $16 \times 16 \times 16 = 4096$

Color mask: AAAARRRRGGGGBBBB

(AAAA = 0xF - opaque)

(AAAA = 0x0 - transparent)

### 6.6.7.25 GUICC\_555: 15 bpp

Use of this mode is necessary for a display controller that supports RGB colors with a color-depth of 15 bpp. The red, green and blue components are each 5 bits.

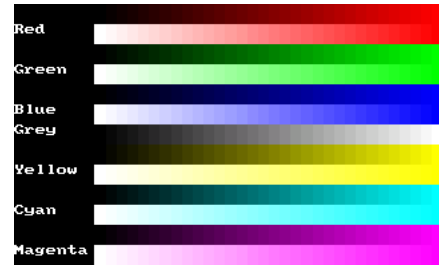

Available colors:  $32 \times 32 \times 32 = 32768$   
 Color mask: BBBBGGGGRRRRR

### 6.6.7.26 GUICC\_M555: 15 bpp, red and blue swapped

Use of this mode is necessary for a display controller that supports RGB colors with a color-depth of 15 bpp. The red, green and blue components are each 5 bits. The available colors are the same as those in 555 mode.



Available colors:  $32 \times 32 \times 32 = 32768$   
 Color mask: RRRRRGGGGBBBBB

### 6.6.7.27 GUICC\_M1555I: 15 bits colors + 1 bit transparency

The available colors are the same as those in 565 mode. The red, green and blue components are each 5 bits, the upper bit is used for transparency.



Available colors:  $32 \times 32 \times 32 = 32768$   
 Color mask: A RRRRRGGGGBBBBB  
 (A = 1 - opaque)  
 (A = 0 - transparent)

### 6.6.7.28 GUICC\_565: 16 bpp

Use of this mode is necessary for a display controller that supports RGB colors with a color-depth of 16 bpp. The red and the blue component is 5 bits and the green component is 6 bit.



Available colors:  $32 \times 64 \times 32 = 65536$

Color mask: BBBBGGGGGRRRRR

### 6.6.7.29 GUICC\_M565: 16 bpp, red and blue swapped

Use of this mode is necessary for a display controller that supports RGB colors with a color-depth of 16 bpp. The available colors are the same as those in 565 mode.

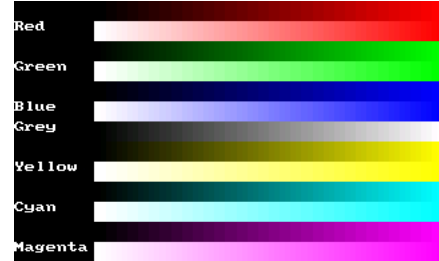

Available colors:  $32 \times 64 \times 32 = 65536$

Color mask: RRRRGGGGGGBBBBB

### 6.6.7.30 GUICC\_666: 18 bpp

Use of this mode is necessary for a display controller that supports RGB colors with a color-depth of 18 bpp. The red, green and blue component is 6 bit.

Available colors:  $64 \times 64 \times 64 = 262144$  Color mask: BBBBGGGGGRRRRR

### 6.6.7.31 GUICC\_M666: 18 bpp, red and blue swapped

Use of this mode is necessary for a display controller that supports RGB colors with a color-depth of 18 bpp. The red, green and the blue component is 6 bit.

Available colors:  $64 \times 64 \times 64 = 262144$  Color mask: RRRRGGGGGGBBBBB

### 6.6.7.32 GUICC\_666\_9: 18 bpp

Use of this mode is necessary for a display controller that supports RGB colors with a color-depth of 18 bpp. The red, green and blue component is 6 bit.

Available colors:  $64 \times 64 \times 64 = 262144$

Color mask: 000000BBBBB-

BGGG000000GGGRRRRR

### 6.6.7.33 GUICC\_M666\_9: 18 bpp, red and blue swapped

Use of this mode is necessary for a display controller that supports RGB colors with a color-depth of 18 bpp. The red, green and blue component is 6 bit.

Available colors:  $64 \times 64 \times 64 = 262144$  Color mask: 000000RRRRRGGG000000GGG-  
BBBBB

### 6.6.7.34 GUICC\_666\_18: 18 bpp

Use of this mode is necessary for a display controller that supports RGB colors with a color-depth of 18 bpp. The red, green and blue component is 6 bit.

Available colors:  $64 \times 64 \times 64 = 262144$

Color mask: 0000000BBBBB0GGGGG00R-

RRRR00

### 6.6.7.35 GUICC\_M666\_18: 18 bpp, red and blue swapped

Use of this mode is necessary for a display controller that supports RGB colors with a color-depth of 18 bpp. The red, green and blue component is 6 bit.

Available colors:  $64 \times 64 \times 64 = 262144$  Color mask:  
 00000000RRRRRR00GGGGGG00BBBBBB00

### 6.6.7.36 GUICC\_822216: 8 bpp, 2 levels per color + 8 grayscales + 16 levels of alpha blending

This mode can be used with a programmable color lookup table (LUT), supporting a total of 256 possible colors and alpha blending support. It supports the 8 basic colors, 8 grayscales and 16 levels of alpha blending for each color / grayscale. With other words it can be used if only a few colors are required but more levels of alpha blending.

Available colors:  $(2 \times 2 \times 2 + 8) \times 16 = 256$

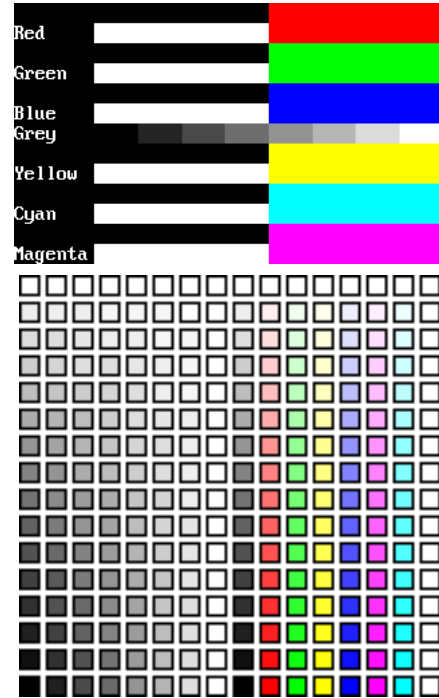

### 6.6.7.37 GUICC\_84444: 8 bpp, 4 levels per color + 16 grayscales + 4(3) levels of alpha blending

This mode can be used with a programmable color lookup table (LUT), supporting a total of 240 possible colors and alpha blending support. 4 levels of intensity are available for each color, in addition to 16 grayscales and 4 levels of alpha blending for each color / grayscale. With other words it can be used if only a few levels of alpha blending are required and different shades of colors.



Available colors:  $(4 \times 4 \times 4 + 16) \times 3 = 240$

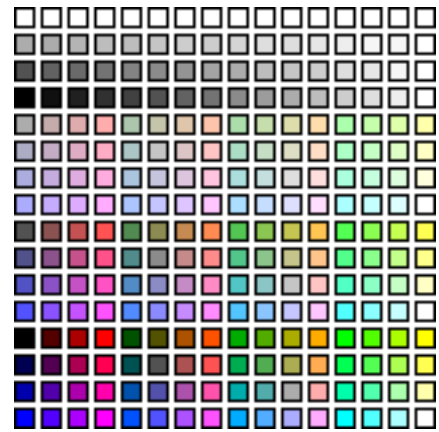

### 6.6.7.38 GUICC\_8666: 8bpp, 6 levels per color + 16 grayscales

This mode is most frequently used with a programmable color lookup table (LUT), supporting a total of 256 possible colors using a palette. The screenshot gives an idea of the available colors; this mode contains the best choice for general purpose applications. Six levels of intensity are available for each color, in addition to 16 grayscales.



Available colors:  $6 \times 6 \times 6 + 16 = 232$

### 6.6.7.39 GUICC\_8666\_1: 8bpp, 6 levels per color + 16 grayscales + transparency

This mode is most frequently used with MultiLayer configurations and a programmable color lookup table (LUT), supporting a total of 256 possible colors using a palette. The difference between 8666 and 86661 is, that the first color indices of the 86661 mode are not used. So the color conversion routine GUI\_Color2Index() does never return 0 which is used for transparency.



Available colors:  $6 \times 6 \times 6 + 16 = 232$



### 6.6.7.40 GUICC\_88666I: 16bpp - 8 bits color (6 levels per color + 16 greyscales) + 8 bits alpha blending

The available colors of this mode are exactly the same as described under GUICC\_8666. The upper 8 bits are used for alpha blending.



Color mask: AAAAAAAAAACCCCCCCC  
 (AAAAAAAAA = 0xFF - opaque)  
 (AAAAAAAAA = 0x00 - transparent)

### 6.6.7.41 GUICC\_888: 24 bpp

Use of this mode is necessary for a display controller that supports RGB colors with a color depth of 24 bpp. The red, green and blue components are each 8 bits.

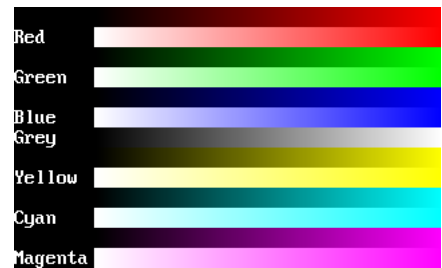

Available colors:  $256 \times 256 \times 256 = 16777216$   
 Color mask: BBBBGGGGGGRRRRRR

### 6.6.7.42 GUICC\_M888: 24 bpp, red and blue swapped

Use of this mode is necessary for a display controller that supports RGB colors with a color depth of 24 bpp. The red, green and blue components are each 8 bits.

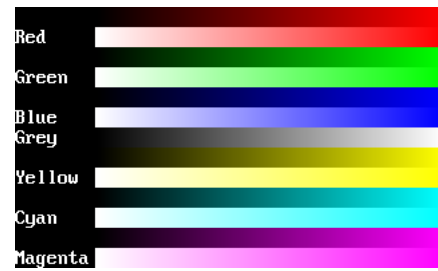

Available colors:  $256 \times 256 \times 256 = 16777216$   
 Color mask: RRRRRRRRGGGGGGGGBBBBBBBB

#### 6.6.7.43 GUICC\_8888: 32 bpp

Use of this mode is necessary for a display controller that supports RGB colors with a color depth of 32 bpp, where the lower 3 bytes are used for the color components and the upper byte is used for alpha blending. The red, green, blue and alpha blending components are each 8 bits.

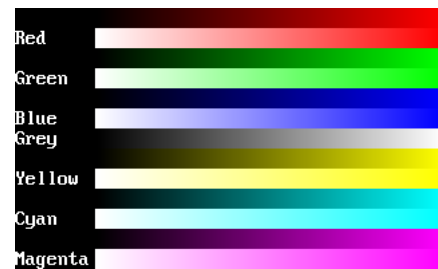

Available colors:  $256 \times 256 \times 256 = 16777216$   
 Color mask: AAAAAAAAABBBBBBBGGGGGGGRRRRRRRR

#### 6.6.7.44 GUICC\_8888I: 32 bpp

Use of this mode is necessary for a display controller that supports RGB colors with a color depth of 32 bpp, where the lower 3 bytes are used for the color components and the upper byte is used for alpha blending. The red, green, blue and alpha blending components are each 8 bits. The alpha component is inverted.

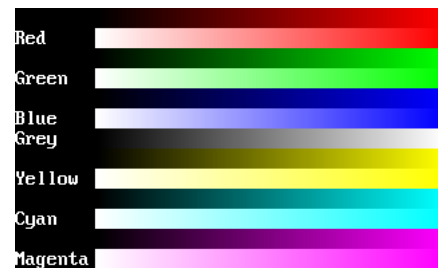

Color mask: AAAAAAAAABBBBBBBGGGGGGGRRRRRRRR  
 (AAAAAAAA = 0xFF - opaque)  
 (AAAAAAAA = 0x00 - transparent)

#### 6.6.7.45 GUICC\_M8888: 32 bpp, red and blue swapped

Use of this mode is necessary for a display controller that supports RGB colors with a color depth of 32 bpp, where the lower 3 bytes are used for the color components and the upper byte is used for alpha blending. The red, green, blue and alpha blending components are each 8 bits.

Available colors:  $256 \times 256 \times 256 = 16777216$   
 Color mask: AAAAAAAAAARRRRRRRRGGGGGGGG-  
 BBBBBBBB

### 6.6.7.46 GUICC\_M8888I: 32 bpp, red and blue swapped

The color mode is exactly the same as described under GUICC\_M8888 with the difference, that alpha blending is inverted.

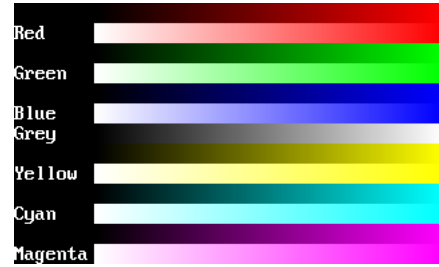

Color mask: AAAAAAAAAARRRRRRRRGGGGGGGGBBBBBBBB  
 (AAAAAAAA = 0xFF - opaque)  
 (AAAAAAAA = 0x00 - transparent)

### 6.6.7.47 GUICC\_0: Custom palette mode

How to use a custom palette mode is described under *Application defined color conversion* on page 628.

### 6.6.7.48 GUICC\_1\_2, GUICC\_1\_4, ... GUICC\_1\_24

These color conversion routines make it possible, to use display drivers which require a color depth of more than 1bpp, with emWin packages containing no support for colors or grayscales. The routines ensure that each color of the whole palette of possible colors will be converted into black or white.

#### Example

If the available emWin package does not contain color- or gray scale support and only a driver, which requires index values of 16 bits is available, GUICC\_1\_16 can be used. This color conversion scheme ensures that each color of the whole 16 bit palette will be converted into 0xFFFF (normally white) or 0x0000 (normally black).

## 6.6.8 Application defined color conversion

If none of the fixed palette modes matches the need of color conversion this mode makes it possible to use application defined color conversion routines. The purpose of these routines is converting an RGB value into an index value for the hardware and vice versa.

### Example of defining custom color conversion routines

The following example should explain how it works:

```
static unsigned _Color2Index_User(LCD_COLOR Color) {
    unsigned Index;
    /* Add code for converting the RGB value to an index value for the hardware */
    return Index;
}
static LCD_COLOR _Index2Color_User(unsigned Index) {
    LCD_COLOR Color;
    /* Add code for converting the index value into an RGB value */
    return Color;
}
static unsigned _GetIndexMask_User(void) {
    return 0xffff; /* Example for using 16 bits */
}
const LCD_API_COLOR_CONV LCD_API_ColorConv_User = {
    _Color2Index_User,
    _Index2Color_User,
    _GetIndexMask_User
};
```

The function `LCD_Color2Index_User` is called by `emWin` if a RGB value should be converted into an index value for the display controller whereas the function `LCD_Index2Color_User()` is called if an index value should be converted into a RGB value.

`LCD_GetIndexMask_User` should return a bit mask value, which has each bit set to 1 which is used by the display controller and unused bits should be set to 0. For example the index mask of `GUICC_44416` mode is `0BBBB0GGGG0RRRR0`, where 0 stands for unused bits. The bit mask for this mode is `0x7BDE`.

### Example of using custom color conversion routines

As described in the chapter *Configuration* on page 109 a pointer to an API table is required for creating the display driver device. As shown in the example above the API table consists of function pointers to the color conversion routines.

A good location for the API table and the color conversion routines is the configuration file `LCDConf.c` located in the `Config` folder. The routines can be used as follow in the function `LCD_X_Config` which is responsible to create the display driver device:

```
void LCD_X_Config(void) {
    //
    // Set display driver and color conversion for 1st layer
    //
    GUI_DEVICE_CreateAndLink(GUIDRV_LIN_16, &LCD_API_ColorConv_User, 0, 0);
    .
    .
    .
}
```

## 6.6.9 Custom palette mode

If none of the fixed palette modes fulfills the requirements of the application emWin is able to use a custom palette. A custom palette simply lists all the available colors in the same order as they are used by the hardware. This means that no matter what colors the display controller/display combination is able to display, emWin will be able to simulate them in the PC simulation and handle these colors correctly in the target system. Working with a custom palette requires a color depth  $\leq 8$  bpp.

A custom palette is typically configured during the initialization in the function `LCD_X_Config()` which is responsible for creating and configuring the display driver device. This requires setting the look-up table entries using the function `LCD_SetLUTEntryEx()` which in turn is called by the functions `LCD_SetLUT()` and `LCD_SetLUTEx()`. These functions are implemented in the custom palette mode module `GUICC_0.c`, but might require modification according to the used hardware. Detailed information can be found in the according function descriptions in the section *Look-up table API* on page 629.

### Example

The following example should show how a custom palette can be used. It passes the palette to the function:

```
static const LCD_COLOR _aColors_16[] = {
    0x000000, 0x0000FF, 0x00FF00, 0x00FFFF,
    0xFF0000, 0xFF00FF, 0xFFFF00, 0xFFFFFF,
    0x000000, 0x000080, 0x008000, 0x008080,
    0x800000, 0x800080, 0x808000, 0x808080,
};
static const LCD_PHYSPALETTE _aPalette_16 = {
    COUNTOF(_aColors_16), _aColors_16
};
void LCD_X_Config(void) {
    //
    // Set display driver and color conversion for 1st layer
    //
    .
    .
    .
    //
    // Set user palette data (only required if no fixed palette is used)
    //
    LCD_SetLUTEx(0, _aPalette_16);
}
```

### Elements of structure LCD\_PHYSPALETTE

Data type	Element	Description
int	NumEntries	Number of entries to be stored in the look-up table.
const LCD_COLOR *	pPalEntries	Pointer to an array of colors. The number of elements in this array has to match at least the value stored in NumEntries.

### 6.6.9.1 Look-up table API

Routine	Description
<code>LCD_SetLUT()</code>	Sets the look-up table for the currently selected layer.
<code>LCD_SetLUTEx()</code>	Sets the look-up table for the given layer.
<code>LCD_SetLUTEntryEx()</code>	Sets one entry in the look-up table.

### 6.6.9.1.1 LCD\_SetLUT()

#### Description

Sets the look-up table for the currently selected layer. This function is defined in the module `GUICC_0.c`. It may require modification according to the used hardware.

#### Prototype

```
void LCD_SetLUT(const LCD_PHYSPALETTE * pPalette);
```

#### Parameters

Parameter	Description
<code>pPalette</code>	Pointer to a <code>LCD_PHYSPALETTE</code> structure.

### 6.6.9.1.2 LCD\_SetLUTEx()

#### Description

Sets the look-up table for the given layer. This function is defined in the module `GUICC_0.c`. It may require modification according to the used hardware.

#### Prototype

```
void LCD_SetLUTEx(      int          LayerIndex,  
                      const LCD_PHYSPALETTE * pPalette);
```

#### Parameters

Parameter	Description
<code>LayerIndex</code>	Index of the layer to set the look-up table for.
<code>pPalette</code>	Pointer to an <code>LCD_PHYSPALETTE</code> structure.

### 6.6.9.1.3 LCD\_SetLUTEntryEx()

#### Description

Sets one entry in the look-up table.

#### Prototype

```
int LCD_SetLUTEntryEx(int LayerIndex,  
                     U8 Pos,  
                     LCD_COLOR Color);
```

#### Parameters

Parameter	Description
<a href="#">LayerIndex</a>	Index of the layer the look-up entry has to be set for.
<a href="#">Pos</a>	Position in the look-up table to use for this color.
<a href="#">Color</a>	32-bit color value.

#### Return value

0 on success  
1 on error.



## 6.6.10 Gamma correction

Gamma correction can simply be achieved with custom color conversion routines. The trick is converting the colors twice. Please note that gamma correction does not work within the simulation.

### Color2Index - conversion

It should first make the gamma correction of the color to be converted. The result of the gamma correction then should be passed to the Color2Index-function of the desired fixed palette mode, whose result then should be returned.

### Index2Color - conversion

It should first convert the index to a color with the Color2Index-function of the desired fixed palette mode. The result then should be passed to the gamma correction routine whose result then should be returned.

### Example

The sample folder `LCDCConf\Common\` contains the sample file `LCDCConf_GammaCorrection.c`. It shows in detail how gamma correction can be used.

## 6.6.11 Color API

The following table lists the available color-related functions in alphabetical order within their respective categories. Detailed description of the routines can be found in the sections that follow.

Basic functions	
<code>GUI_GetBkColor()</code>	Returns the current background color.
<code>GUI_GetBkColorIndex()</code>	Returns the index of the current background color.
<code>GUI_GetColor()</code>	Returns the current foreground color.
<code>GUI_GetColorIndex()</code>	Returns the index of the current foreground color.
<code>GUI_GetDefaultColor()</code>	Returns currently set default foreground color.
<code>GUI_GetDefaultBkColor()</code>	Returns currently set default background color.
<code>GUI_SetBkColor()</code>	Sets the default background color.
<code>GUI_SetBkColorIndex()</code>	Sets the index of the current background color.
<code>GUI_SetBlendBkColor()</code>	Blends two colors and sets it as the current background color.
<code>GUI_SetBlendBkColorEx()</code>	Blends two colors with a given intensity range and sets it as the current background color.
<code>GUI_SetBlendColor()</code>	Blends two colors and sets it as the current foreground color.
<code>GUI_SetBlendColorEx()</code>	Blends two colors with a given intensity range and sets it as the current foreground color.
<code>GUI_SetColor()</code>	Sets the current foreground color.
<code>GUI_SetColorIndex()</code>	Sets the index of the current foreground color.
<code>GUI_SetDefaultColor()</code>	Sets the default foreground color.
<code>GUI_SetDefaultBkColor()</code>	Sets the default background color.
Conversion functions	
<code>GUI_BlendColors()</code>	Blends two color with the given intensity.
<code>GUI_Color2Index()</code>	Returns the index of a specified RGB color value.

<code>GUI_Color2VisColor()</code>	Returns the next available color of the system as an RGB color value.
<code>GUI_ColorIsAvailable()</code>	Checks if the given color is available.
<code>GUI_Index2Color()</code>	Returns the RGB color value of a specified index.

## 6.6.11.1 Basic functions

### 6.6.11.1.1 GUI\_GetBkColor()

#### Description

Returns the current background color.

#### Prototype

```
GUI_COLOR GUI_GetBkColor(void);
```

#### Return value

The current background color.

### 6.6.11.1.2 GUI\_GetBkColorIndex()

#### Description

Returns the index of the current background color.

#### Prototype

```
int GUI_GetBkColorIndex(void);
```

#### Return value

The current background color index.

### 6.6.11.1.3 GUI\_GetColor()

#### Description

Returns the current foreground color.

#### Prototype

```
GUI_COLOR GUI_GetColor(void);
```

#### Return value

The current foreground color.

#### 6.6.11.1.4 GUI\_GetColorIndex()

##### Description

Returns the index of the current foreground color.

##### Prototype

```
int GUI_GetColorIndex(void);
```

##### Return value

The current foreground color index.

### 6.6.11.1.5 GUI\_GetDefaultColor()

#### Description

Returns currently set default foreground color.

#### Prototype

```
GUI_COLOR GUI_GetDefaultColor(void);
```

#### Return value

The default foreground color.

### 6.6.11.1.6 GUI\_GetDefaultBkColor()

#### Description

Returns currently set default background color.

#### Prototype

```
GUI_COLOR GUI_GetDefaultBkColor(void);
```

#### Return value

The current default background color.



### 6.6.11.1.7 GUI\_SetBkColor()

#### Description

Sets the default background color.

#### Prototype

```
void GUI_SetBkColor(GUI_COLOR Color);
```

#### Parameters

Parameter	Description
Color	Color for background, 24-bit RGB value.

### 6.6.11.1.8 GUI\_SetBkColorIndex()

#### Description

Sets the index of the current background color.

#### Prototype

```
void GUI_SetBkColorIndex(LCD_PIXELINDEX Index);
```

#### Parameters

Parameter	Description
<a href="#">Index</a>	<a href="#">Index</a> of the color to be used.

### 6.6.11.1.9 GUI\_SetBlendBkColor()

#### Description

Blends two colors and sets it as the current background color.

#### Prototype

```
GUI_COLOR GUI_SetBlendBkColor(GUI_COLOR Color0,  
                               GUI_COLOR Color1,  
                               U8          Intens);
```

#### Parameters

Parameter	Description
<a href="#">Color0</a>	RGB value of the first color.
<a href="#">Color1</a>	RGB value of the second color.
<a href="#">Intens</a>	Intensity to be used to blend the colors (0 - 255).

#### Return value

Resulting color of blending between [Color0](#) and [Color1](#).

### 6.6.11.1.10 GUI\_SetBlendBkColorEx()

#### Description

Blends two colors with a given intensity range and sets it as the current background color.

#### Prototype

```
GUI_COLOR GUI_SetBlendBkColorEx(GUI_COLOR Color0,  
                                GUI_COLOR Color1,  
                                U16      Intens,  
                                U16      IMax);
```

#### Parameters

Parameter	Description
<a href="#">Color0</a>	RGB value of the first color.
<a href="#">Color1</a>	RGB value of the second color.
<a href="#">Intens</a>	Intensity to be used to blend the colors.
<a href="#">IMax</a>	Defines range of intensity.

#### Return value

Resulting color of blending between [Color0](#) and [Color1](#).

### 6.6.11.1.11 GUI\_SetBlendColor()

#### Description

Blends two colors and sets it as the current foreground color.

#### Prototype

```
GUI_COLOR GUI_SetBlendColor(GUI_COLOR Color0,  
                             GUI_COLOR Color1,  
                             U8          Intens);
```

#### Parameters

Parameter	Description
<a href="#">Color0</a>	RGB value of the first color.
<a href="#">Color1</a>	RGB value of the second color.
<a href="#">Intens</a>	Intensity to be used to blend the colors (0 - 255).

#### Return value

Resulting color of blending between [Color0](#) and [Color1](#).

### 6.6.11.1.12 GUI\_SetBlendColorEx()

#### Description

Blends two colors with a given intensity range and sets it as the current foreground color.

#### Prototype

```
GUI_COLOR GUI_SetBlendColorEx(GUI_COLOR Color0,  
                               GUI_COLOR Color1,  
                               U16      Intens,  
                               U16      IMax);
```

#### Parameters

Parameter	Description
<a href="#">Color0</a>	RGB value of the first color.
<a href="#">Color1</a>	RGB value of the second color.
<a href="#">Intens</a>	Intensity to be used to blend the colors.
<a href="#">IMax</a>	Defines range of intensity.

#### Return value

Resulting color of blending between [Color0](#) and Color1.

### 6.6.11.1.13 GUI\_SetColor()

#### Description

Sets the current foreground color.

#### Prototype

```
void GUI_SetColor(GUI_COLOR color);
```

#### Parameters

Parameter	Description
Color	Color for foreground, 24-bit RGB value.

#### 6.6.11.1.14 GUI\_SetColorIndex()

##### Description

Sets the index of the current foreground color.

##### Prototype

```
void GUI_SetColorIndex(LCD_PIXELINDEX Index);
```

##### Parameters

Parameter	Description
<a href="#">Index</a>	<a href="#">Index</a> of the color to be used.



### 6.6.11.1.15 GUI\_SetDefaultColor()

#### Description

Sets the default foreground color.

#### Prototype

```
void GUI_SetDefaultColor(GUI_COLOR Color);
```

#### Parameters

Parameter	Description
Color	Color for foreground, 24-bit RGB value.

### 6.6.11.1.16 GUI\_SetDefaultBkColor()

#### Description

Sets the default background color.

#### Prototype

```
void GUI_SetDefaultBkColor(GUI_COLOR Color);
```

#### Parameters

Parameter	Description
Color	Color for foreground, 24-bit RGB value.

## 6.6.11.2 Conversion functions

### 6.6.11.2.1 GUI\_BlendColors()

#### Description

Blends two color with the given intensity.

#### Prototype

```
GUI_COLOR GUI_BlendColors(GUI_COLOR Color0,  
                           GUI_COLOR Color1,  
                           U16      Intens,  
                           U16      IMax);
```

#### Parameters

Parameter	Description
<a href="#">Color0</a>	RGB value of the first color.
<a href="#">Color1</a>	RGB value of the second color.
<a href="#">Intens</a>	Intensity to be used to blend the colors.
<a href="#">IMax</a>	Defines range of intensity.

#### Return value

A combination of the given colors according to the intensity.

#### Additional information

[IMax](#) is used to define the range of the intensity. For example, if a value of 4 is passed as [IMax](#). [Intens](#) can have a value between 0 to 4. The maximum value is 0xFFFF.

### 6.6.11.2.2 GUI\_Color2Index()

#### Description

Returns the index of a specified RGB color value.

#### Prototype

```
int GUI_Color2Index(GUI_COLOR Color);
```

#### Parameters

Parameter	Description
Color	RGB value of the color to be calculated.

#### Return value

The color index.

### 6.6.11.2.3 GUI\_Color2VisColor()

#### Description

Returns the next available color of the system as an RGB color value.

#### Prototype

```
GUI_COLOR GUI_Color2VisColor(GUI_COLOR color);
```

#### Parameters

Parameter	Description
Color	RGB value of the color.

#### Return value

The RGB color value of the nearest available color.

#### 6.6.11.2.4 GUI\_ColorIsAvailable()

##### Description

Checks if the given color is available.

##### Prototype

```
char GUI_ColorIsAvailable(GUI_COLOR color);
```

##### Parameters

Parameter	Description
Color	RGB value of the color.

##### Return value

1 if color is available  
0 if not.

### 6.6.11.2.5 GUI\_Index2Color()

#### Description

Returns the RGB color value of a specified index.

#### Prototype

```
GUI_COLOR GUI_Index2Color(int Index);
```

#### Parameters

Parameter	Description
<code>Index</code>	<code>Index</code> of the color to be converted.

#### Return value

The RGB color value.

## 6.7 Fonts

This chapter describes the various methods of font support in emWin. The most common fonts are shipped with emWin as C font files. All of them contain the ASCII character set and most of them do also contain the characters included in the ISO 8859-1 character set. In fact, you will probably find that these fonts are fully sufficient for your application. For detailed information about the individual fonts, refer to *Standard fonts* on page 666.

emWin is compiled for 8-bit characters, allowing for a maximum of 256 different character codes out of which the first 32 are reserved as control characters. The availability of characters depends on the font. In order to display certain characters selecting an according font may be required. For accessing the complete 'Basic Multilingual Plane' (BMP, plane 0) of the Unicode codespace UTF8 decoding could be enabled. Details can be found in the chapter *Language Support* on page 898.

TrueType font files (TTF) can also be used directly. Support for those kind of fonts can be achieved by adding the FreeType library which comes with its own BSD style license. More details about TTF support and a download link can be found under *TrueType Font (TTF) format* on page 662.

### 6.7.1 Introduction

The first way of font support was the possibility to use C files with font definitions containing bitmaps with 1bpp pixel information for each character. This kind of font support was limited to use only the fonts which are compiled with the application. Over time, the font support has been improved regarding font quality, ROM requirement, performance, scalability and the ability to add further fonts at run time. In the meantime emWin fonts cover anti-aliasing, drawing of compound characters like required in Thai language, fonts located on external non addressable media and TrueType support. Except the TrueType font format, which is a vector font, all other kinds of fonts are bitmap fonts.

### 6.7.2 Requirements

Some characters are required within a font to measure certain font parameters such as the height of lower and upper case characters.

#### TrueType fonts

TTF and BDF fonts created during runtime with the FreeType engine are using the following characters for measurements:

Character	Purpose
<b>g</b>	Measurement of the height of lower case characters.
<b>M</b>	Measurement of the height of upper case characters.

The above characters can be changed using the routine `GUI_FT_SetMeasurementChars()`.



## 6.7.3 Font types

emWin supports different internal types of fonts defined by emWin supports TrueType and BDF fonts through the FreeType library.

### Note

To avoid confusion (especially with new emWin users), with emWin V6.36 the old font formats that were formerly known as *Standard* fonts have been renamed to **Legacy** fonts.

In most cases font formats formerly known as *Extended* fonts should be used, because they are much more memory efficient. Therefore these formats are now called **Standard** fonts.

The new names give a more accurate description about the formats, because legacy font formats should only be used if absolutely necessary.

### Standard proportional bitmap fonts

Each character of an extended proportional bitmap font has its own height and its own width. The pixel information is saved with 1bpp and covers only the areas of the glyph bitmaps.

### Standard proportional bitmap fonts with 2 bpp anti-aliasing information

Each character has the same height and its own width. The pixel information is saved with 2bpp anti-aliasing information and covers only the areas of the glyph bitmaps.

### Standard proportional bitmap fonts with 4 bpp anti-aliasing information

Each character has the same height and its own width. The pixel information is saved with 4bpp anti-aliasing information and covers only the areas of the glyph bitmaps.

### Standard proportional bitmap fonts, framed

In case the background color is unknown at compile time, it might be preferable to use a framed font. A framed font is always drawn in transparent mode regardless of the current settings. The character pixels are drawn in the currently selected foreground color and the frame is drawn in background color. A good contrast between foreground and background color makes sure, that the text can be read on any background.

### Note

Framed fonts are not suitable for compound characters like in the Thai or Arabic language.

The picture below shows some framed text in front of a photo:



### Monospaced bitmap fonts

Each character of a monospaced bitmap font has the same size. In a proportional font each character has its own width, whereas in a monospaced font the width is defined only one time. The pixel information is saved with 1bpp and covers the whole character area.

Some of the standard fonts that are included in emWin are in the monospaced format. But monospaced fonts cannot be created using the Font Converter.

**Legacy proportional bitmap fonts**

Each character of a proportional bitmap font has the same height and its own width. The pixel information is saved with 1bpp and covers the whole character area.

**Legacy anti-aliased fonts with 2 bpp anti-aliasing information**

Each character has the same height and its own width. The pixel information is saved with 2bpp anti-aliasing information and covers the whole character area.

**Legacy anti-aliased fonts with 4 bpp anti-aliasing information**

Each character has the same height and its own width. The pixel information is saved with 4bpp anti-aliasing information and covers the whole character area.

**Standard font types**

The following table shows the difference between the standard font types. The images only show the pixel information saved in the font file.

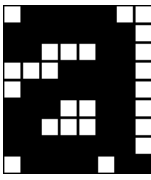
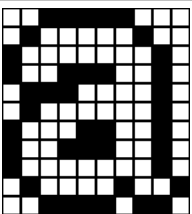
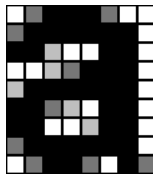
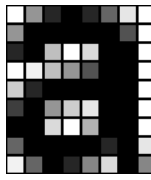
Std. prop. bitmap font	Std. prop. bitmap font, framed	Std. prop. bitmap font, AA2	Std. prop. bitmap font, AA4
			

**Legacy font types**

The following table shows the difference between the legacy font types. The images only show the pixel information saved in the font file.

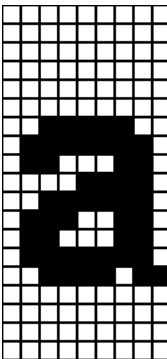
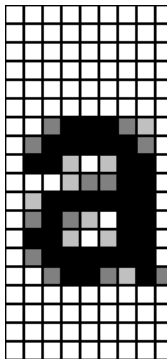
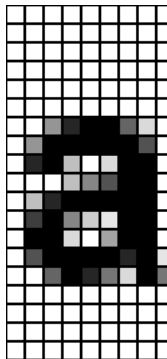
Leg. prop. bitmap font	Leg. prop. bitmap font, AA2	Leg. prop. bitmap font, AA4
		

**FreeType library support**

emWin supports the use of TrueType and BDF fonts through the FreeType library. More detail about this is described later in this chapter.

## 6.7.4 Font file formats

The following explains the differences between the supported font formats, when to use them and what is required to be able to use them.

### 6.7.4.1 C file format

This is the most common way of using fonts. When using fonts in form of C files, we recommend compiling all available fonts and linking them as library modules or putting all of the font object files in a library which you can link with your application. This way you can be sure that only the fonts which are needed by your application are actually linked. The Font Converter may be used to create additional fonts.

#### When to use

This format should be used if the fonts are known at compile time and if there is enough addressable memory available for the font data.

#### Requirements

In order to be able to use a font C file in your application, the following requirements must be met:

- The font file is in a form compatible with emWin as C file, object file or library.
- The font file is linked with your application.
- The font declaration is contained in the application.

#### Format description

A font C file contains at first the pixel information of all characters included by the font. It is followed by a character information table with size information about each character. This table is followed by range information structures for each contiguous area of characters contained in the font file, whereas each structure points to the next one. Note that this method can enlarge a font file a lot if using many separate characters. After the range information structures a `GUI_FONT` structure follows with the main information like type, pixel size and so on of the font.

### 6.7.4.2 System Independent Font (SIF) format

System independent fonts are binary data blocks containing the font information. The Font Converter can be used to create system independent fonts. This tool is not part of the basic package. A short description follows later in this chapter.

#### When to use

This format should be used if the fonts are not known at compile time and if there is enough addressable memory available for the font data.

#### Requirements

In order to be able to use a SIF font file in your application, it is required that the whole file reside in addressable memory (ROM or RAM).

#### Format description

The structure of a SIF file is nearly the same as of a C file. It contains the same information in binary format. The sequence of the file components is vice versa: General font information followed by range information structures, character information table and at least pixel information of all characters.

### 6.7.4.3 External Bitmap Font (XBF) format

As well as SIF fonts XBF fonts are binary data blocks containing the font information and the Font Converter can be used to create XBF files. The Font Converter is not part of the emWin basic package. Details on how to create external bitmap fonts can be found in the chapter *Font Converter* on page 3136.

#### Advantages

Contrary to other fonts, XBF fonts do not have to reside in memory when they are used, whereas all other kinds of emWin fonts need to reside in memory completely. The XBF font file can remain on any external media while it is used. Data access is done by a `GetData` callback function. The advantage of XBF fonts is that it is possible to use very large fonts on systems with little memory.

XBF fonts offer a performance advantage when using fonts including lots of characters which do not follow each other directly in sequence. This kind of character set would cause the Font Converter to create a C file font containing many `GUI_FONT_PROP` structures having a pointer to the according next one. The more `GUI_FONT_PROP` structures exist in a font the longer it might take to display a character. XBF fonts just use a memory offset so each character can be found in the same amount of time.

#### When to use

This format should be used if there is not enough addressable memory available for the font data and if there is any kind of external media available for storing the fonts.

#### Requirements

In order to be able to use a XBF font in your application, a `GetData` callback function is required which is responsible for getting font data.

#### Format description

This format differs in general from SIF and C file format. At first it contains a small block of general font information including the lowest character code and the highest character code. It is followed by an access table containing offset and data size information for each character between lowest and highest character code. If a character does not exist, this information is zero for the according character. The access table is followed by the character information of all characters containing pixel data and character size information.

#### File content

```
(all values LSB):
Header (18 Bytes)
  4 Bytes ID (0x47, 0x55, 0x49, 0x58, "GUIX")
  16 Bits ySize of font
  16 Bits yDist of font, to be used for cursor increment
  16 Bits Baseline position from top
  16 Bits Height in pixels of lowercase characters
  16 Bits Height in pixels of capital characters
  16 Bits First codepoint in access table
  16 Bits Last codepoint in access table
Character Access table (6 Bytes for each entry)
  32 Bits Position of bitmap information in file (0 means character is not
  available)
  16 Bits Size of bitmap information
Bitmap Information (Standard font format)
  12 Bytes header:
    16 Bits X-distance in pixels to be used for cursor increment
    16 Bits X-size of bitmap
    16 Bits Y-size of bitmap
    16 Bits X-position of bitmap
    16 Bits Y-position of bitmap
    16 Bits Bytes per line of bitmap
  Bitmap (Size - 12 bytes)
```

```

Bitmap Information (Legacy font format)
  4 Bytes header:
    16 Bits X-size of bitmap
    16 Bits Y-size of bitmap
  Bitmap (Size - 4 bytes)

```

#### 6.7.4.4 iType and iTypeSpark font engine support

Since version V5.20 emWin supports using the iType® font engine, since V5.30 it also supports the iTypeSpark® engine. The iType® and iTypeSpark® font engines are font rendering subsystems developed by Monotype Imaging. They offer a host of advanced capabilities including font linking, font management and discovery, support for various industry standards and font formats in a small memory footprint. iType® and iTypeSpark® can be implemented into various platforms. Based on OpenType®, TrueType® and PostScript® font formats and packaged as ANSI C code for broad, flexible integration, iType® meets stringent size requirements for any applications, including those that support East Asian languages requiring thousands of characters. The glue code to be able to use the those font engines is freely available under the following links:

- [www.segger.com/downloads/emwin/emWin\\_iType](http://www.segger.com/downloads/emwin/emWin_iType)
- [www.segger.com/downloads/emwin/emWin\\_iTypeSpark](http://www.segger.com/downloads/emwin/emWin_iTypeSpark)

#### Screenshot

*Italic text*  
**Regular bold italic text**  
**Regular bold text**  
**Filled outline**  
 Unfilled outline  
 Embossed text  
 Engraved text  
**Shadow text**  
**Glow text**

#### Licensing

The emWin library by SEGGER does not provide the Monotype® font engines itself. It provides only the glue code required to be able to use the iType® or the iTypeSpark® library. Please contact Monotype Imaging under [monotypeimaging.com](http://monotypeimaging.com) for a license request if required.

#### When to use

This format could be used if high quality fonts need to be scalable at run-time and/or advanced font effects are required.

#### Requirements

In general the requirements are similar to the requirements of the true type font support described on the next page. For detailed information about requirements and performance please also contact Monotype Imaging under [monotypeimaging.com](http://monotypeimaging.com).

### 6.7.4.5 TrueType Font (TTF) format

The functionality of emWin can be enhanced by making use of TrueType fonts. TrueType is an outline font standard developed by Apple Computer. It offers font developers a high degree of control over how their fonts are displayed at various font heights. Contrary to bitmap fonts which are based on bitmaps for each character, TrueType fonts are based on vector graphics. The advantage of the vector representation is the loss-free scalability.

This implies that each character first needs to be rasterized into a bitmap before it is drawn. To avoid rasterization each time a character is drawn the bitmap data normally is cached by the font engine. This requires a fast CPU and enough RAM. TTF support for emWin can be achieved by using the FreeType font library from David Turner, Robert Wilhelm and Werner Lemberg which is not part of emWin. An adapted version of this library ready to use with emWin is available [on our website](#). That library can be added to emWin in order to use the TTF API as explained later in this chapter.

#### Licensing

The use of FreeType font library is subject to a BSD style license with credit clause ([freetype.org](#)) also included in `GUI\TrueType\FTL.txt` of the zip file. The original version of the library is available for free under [freetype.org](#).

#### When to use

This format should be used if fonts need to be scalable at run-time.

#### Requirements

- **CPU:** TTF support works only on 32 bit CPUs. Our definition of a 32bit CPU: `sizeof(int) = 4`.
- **ROM:** The ROM requirement of the TTF engine is approx. 370 KByte. The exact size depends on the CPU, the compiler and the optimization level of the compiler. After excluding a couple of unused modules in the file `ftmodule.h` the requirement is approx. 235 KByte.
- **RAM:** The RAM requirement of the library depends a lot on the used fonts. The basic RAM requirement of the TTF engine is approx. 50 KByte. When creating a GUI font with `GUI_TTF_CreateFont()` the font engine loads all font tables defined in the TTF file required to generate the characters. The table sizes varies a lot between the fonts. The additional required amount of RAM for creating a font can be between a few KB up to more than 1MB. For typical fonts 80-300 KB are required. It depends on the used font file how much RAM is required. At least the TTF engine requires a bitmap cache. Per default the engine uses 200K for the cache. This should be enough for most applications.
- **Stack:** Please note that the FreeType library uses far more stack than emWin alone. We observed that 20 KByte should be enough to run the FreeType library with emWin.

The TTF engine allocates its memory via the non-emWin functions `malloc()` and `free()`. It must be made sure that these functions work before using the TTF engine.

#### Format description

For details about the TTF format, refer to the information available under [apple.com](#).

### 6.7.4.6 Glyph Bitmap Distribution Format (BDF)

The Glyph Bitmap Distribution Format is a bitmap based font format developed by Adobe. The content of BDF files is intended to be readable for humans as well as computers.

Since it is a bitmap based format, fonts have a fixed size and cannot be scaled. The glyph bitmaps have a color depth of 1bpp, thus BDF fonts do not support anti-aliasing.

BDF support for emWin can be achieved by using the FreeType font library from David Turner, Robert Wilhelm and Werner Lemberg which is not part of emWin. An adapted version of this library ready to use with emWin is available [on our website](#). That library can be added to emWin in order to use the BDF API as explained later in this chapter.

Unlike with TTF fonts, the FreeType cache is not used for displaying BDF fonts, since the format is based on bitmaps instead of outlines.

#### Licensing

The use of FreeType font library is subject to a BSD style license with credit clause ([freetype.org](http://freetype.org)) also included in GUI\TrueType\FTL.txt of the zip file. The original version of the library is available for free under [freetype.org](http://freetype.org).

#### When to use

Since BDF is an old format and emWin already provides other bitmap based formats, it should only really be used e.g. when BDF fonts have been licensed previously and are still intended to be used.

#### Format description

For further details about the BDF format, refer to the [specification published by Adobe](#).

#### Limitations

Currently, anti-aliased BDF fonts are not supported.

## 6.7.5 Converting a TTF file to C source

Under some circumstances it can be useful to add a TTF file as C file to the project, for example if no file system is available. This can be done by using the tool `Bin2C.exe` shipped with emWin. It can be found in the `Tools` subfolder. It converts the given binary file (in this case the TTF file) to a C file.

## 6.7.6 Declaring custom fonts

The most recommended way of declaring the prototypes of custom fonts is to put them into an application defined header file. This should be included from each application source file which uses these fonts. It could look like the following example:

```
#include "GUI.h"
extern GUI_CONST_STORAGE GUI_FONT GUI_FontApp1;
extern GUI_CONST_STORAGE GUI_FONT GUI_FontApp2;
```

Note that this kind of declaring prototypes does not work if the fonts should be used with emWin configuration macros like `BUTTON_FONT_DEFAULT` or similar. In this case the fonts need to be declared in the configuration file `GUIConf.h`. The declaration in this case can look like the following example:

```
typedef struct GUI_FONT GUI_FONT;

extern const GUI_FONT GUI_FontApp1;

#define BUTTON_FONT_DEFAULT &GUI_FontApp1
#define EDIT_FONT_DEFAULT &GUI_FontApp1
```

The `typedef` is required because the structure `GUI_FONT` has not been defined at the early point where `GUIConf.h` is included by emWin.

## 6.7.7 Selecting a font

emWin offers different fonts, one of which is always selected. This selection can be changed by calling the function `GUI_SetFont()` or one of the `GUI_XXX_CreateFont()` functions, which select the font to use for all text output to follow for the current task.

If no font has been selected by your application, the default font is used. This default is configured in `GUIConf.h` and can be changed. You should make sure that the default font is one that you are actually using in your application because the default font will be linked with your application and will therefore use up ROM memory.



## 6.7.8 Changing the font style during run-time

Instead of predefining font styles such as bold, italic, etc. using the Font Converter, certain font styles can also be applied to fonts during run-time.

The table below shows which font style is supported by which font type and which function can be used to set the style to the font.

**Note:** All of the styles can be combined with each other, if they are available for the given font type.

Font style	C	SIF	XBF	BDF	TTF
<b>bold</b>	-	-	-	GUI_BDF_Embolden-Font()	GUI_TTF_Embolden-Font()
<i>italic</i>	-	-	-	-	GUI_TTF_Oblique-Font()
<u>underlined</u>	GUI_SetTextStyle(GUI_TS_UNDERLINE)				
<del>strikethrough</del>	GUI_SetTextStyle(GUI_TS_STRIKETHRU)				
<u>overlined</u>	GUI_SetTextStyle(GUI_TS_OVERLINE)				

## 6.7.9 Kerning

Kerning is the process of adjusting the space between two specific characters to promote a visually pleasing and rhythmic flow between letters. The more the text takes center stage, the more the eyes notice small imperfections in it. And one of the most common imperfections is the space between the letters, known as kerning. emwin allows to activate kerning for standard- and TTF fonts. Legacy fonts unfortunately do not support kerning.

No kerning:  
**WAVE**

With kerning:  
**WAVE**

### 6.7.9.1 Standard fonts

Kerning can be used with standard- and TTF-fonts. Monospaced- and legacy fonts unfortunately do not support kerning. In case of using standard fonts the format (C, SIF, XBF) does not matter. Each format can be used with kerning.

#### Creating a kerning table

To be able to activate kerning a kerning table is required. It contains the kerning distance for each pair of codepoints. Please note that such a kerning table should exactly fit to the font it is used with. A kerning table can be created with the FontConverter (File/Save kerning table):

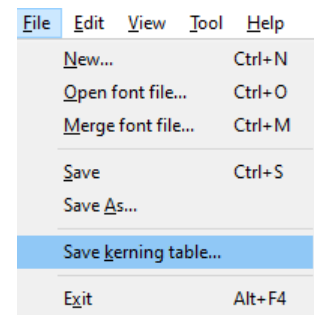

The result is a C-file containing the kerning pairs for the font:

```
//
// Kerning pairs
//
GUI_CONST_STORAGE U16 aMyFont_64_Kerning[] = {
    0x0020, 0x0041, (U16)-3, 0x0020, 0x0054, (U16)-1, 0x0020, 0x0059, (U16)-1, ...
    0x0041, 0x0020, (U16)-3, 0x0041, 0x0054, (U16)-4, 0x0041, 0x0056, (U16)-4, ...
    ...
    0x0077, 0x002E, (U16)-3, 0x0079, 0x002C, (U16)-4, 0x0079, 0x002E, (U16)-4,
};

//
// Number of kerning pairs: 95
//
U32 MyFont_64_Kerning_NumPairs = (sizeof(aMyFont_64_Kerning) / sizeof(aMyFont...
```

This file (or the content of it) needs to be added to the project. It contains the table and the number of pairs. More details can be found in chapter *Font Converter* on page 3136.

#### Activating kerning

Once the font and the kerning table exists, only one function call is required to attach the kerning table to the font structure. This should be done with `GUI_AttachKerning()`:

```
static GUI_KERNING_INFO _KerningData;

//
// Activate kerning for MyFont_64
//
GUI_AttachKerning(&GUI_FontMyFont_64_AA4, &_KerningData, aMyFont_64_Kerning, ...
```

### 6.7.9.2 Kerning with TTF fonts

When working directly with TTF fonts no extra kerning table is required. The function `GUI_TTF_EnableKerning()` can be used to switch kerning on and off for the given font. But please note that not any TTF font contains a kerning table. In short: Not any TTF font supports kerning. The FreeType-library contains the function `FT_HAS_KERNING()` which can be used to check whether kerning is supported or not.

## 6.7.10 Font API

The table below lists the available font-related routines in alphabetical order within their respective categories. Detailed descriptions can be found in the following sections.

### Functions

Routine	Description
SIF file related font functions	
<code>GUI_SIF_CreateFont()</code>	Sets the font to be used by passing a pointer to system independent font data.
<code>GUI_SIF_DeleteFont()</code>	Deletes a font created by <code>GUI_SIF_CreateFont()</code> .
TTF file related font functions	
<code>GUI_TTF_AddRowBottom()</code>	Adds or removes the given number of rows to/from the bottom edge of the TTF font.
<code>GUI_TTF_AddRowTop()</code>	Adds or removes the given number of rows to/from the top edge of the TTF font.
<code>GUI_TTF_CreateFont()</code>	Creates and selects an emWin font by using a TTF font file.
<code>GUI_TTF_CreateFontAA()</code>	Creates and selects an antialiased emWin font by using a TTF font file.
<code>GUI_TTF_EmboldenFont()</code>	Renders the given TTF font as bold.
<code>GUI_TTF_EmboldenFontEx()</code>	Renders the given TTF font as bold.
<code>GUI_TTF_EnableKerning()</code>	Enables kerning (if possible).
<code>GUI_TTF_GetFamilyName()</code>	The function returns the font family name defined in the font file.
<code>GUI_TTF_GetStyleName()</code>	The function returns the style name (bold, regular, ...) defined in the font file.
<code>GUI_TTF_ObliqueFont()</code>	Renders the given TTF font as oblique.
<code>GUI_TTF_ObliqueFontEx()</code>	Renders the given TTF font as oblique.
XBF file related font functions	
<code>GUI_XBF_CreateFont()</code>	Creates and selects a font by passing a pointer to a callback function, which is responsible for getting data from the XBF font file.
<code>GUI_XBF_DeleteFont()</code>	Deletes an XBF font pointed by the parameter <code>pFont</code> .
BDF file related font functions	
<code>GUI_BDF_CreateFont()</code>	Creates and selects an emWin font by using a BDF font file.
<code>GUI_BDF_DeleteFont()</code>	Frees all allocated memory for an emWin font created from a BDF font file.
<code>GUI_BDF_EmboldenFont()</code>	Renders the given BDF font as bold.
<code>GUI_BDF_EmboldenFontEx()</code>	Renders the given BDF font as bold.
<code>GUI_BDF_GetFamilyName()</code>	The function returns the font family name defined in the font file.
<code>GUI_BDF_GetStyleName()</code>	The function returns the style name (bold, regular, ...) defined in the font file.
<code>GUI_BDF_SetLetterSpacing()</code>	Sets a spacing that is added/subtracted to each letter of the font.
FreeType related font functions	

Routine	Description
<code>GUI_FT_DestroyCache()</code>	This function frees all memory allocated by the FreeType cache system and destroys the cache.
<code>GUI_FT_Done()</code>	This function frees all memory allocated by the FreeType engine and its internal cache system.
<code>GUI_FT_GetMeasurementChars()</code>	Returns the characters that are used for measuring the font metrics of newly created TTF and BDF fonts.
<code>GUI_FT_SetCacheSize()</code>	Sets the size parameters used to create the cache on the first call of <code>GUI_TTF_CreateFont()</code> or <code>GUI_BDF_CreateFont()</code> .
<code>GUI_FT_SetMeasurementChars()</code>	Sets the characters that are used for measuring the font metrics of newly created TTF and BDF fonts.
<b>Common font-related functions</b>	
<code>GUI_GetCharDistX()</code>	Returns the width in pixels (X-size) used to display a specified character in the currently selected font.
<code>GUI_GetDefaultFont()</code>	Returns the default currently set default font.
<code>GUI_GetFallbackFont()</code>	Returns a font which contains the given character.
<code>GUI_GetFont()</code>	Returns a pointer to the currently selected font.
<code>GUI_GetFontDistY()</code>	Returns the Y-spacing of the currently selected font.
<code>GUI_GetFontInfo()</code>	Calculates a pointer to a <code>GUI_FONTINFO</code> structure of a particular font.
<code>GUI_GetFontSizeY()</code>	Returns the height in pixels (Y-size) of the currently selected font.
<code>GUI_GetLeadingBlankCols()</code>	Returns the number of leading blank pixel columns in the currently selected font for the given character.
<code>GUI_GetLeadingBlankRows()</code>	Returns the number of leading blank pixel rows in the currently selected font for the given character.
<code>GUI_GetStringDistX()</code>	Returns the X-size used to display a specified string in the currently selected font.
<code>GUI_GetStringDistXEx()</code>	Returns the X-size used to display a number of characters of a string in the currently selected font.
<code>GUI_GetTextExtend()</code>	Calculates the text rectangle for drawing the given string.
<code>GUI_GetTrailingBlankCols()</code>	Returns the number of trailing blank pixel columns in the currently selected font for the given character.
<code>GUI_GetTrailingBlankRows()</code>	Returns the number of trailing blank pixel rows in the currently selected font for the given character.
<code>GUI_GetYDistOfFont()</code>	Returns the Y-spacing of a particular font.
<code>GUI_GetYSizeOfFont()</code>	Returns the Y-size of a particular font.
<code>GUI_IsInFont()</code>	Evaluates whether a particular font contains a specified character or not.

Routine	Description
<code>GUI_SetDefaultFont()</code>	Sets the font to be used by default for text output.
<code>GUI_SetFallbackFont()</code>	Sets a fallback font which is used if the default font does not contain the required characters.
<code>GUI_SetFont()</code>	Sets the font to be used for text output.
<code>GUI_SetFuncGetFallbackFont()</code>	Sets a callback function which is called to retrieve a fallback font.
Kerning related functions	
<code>GUI_AttachKerning()</code>	Attaches a given kerning table to a given font.
<code>GUI_DetachKerning()</code>	Detaches a given kerning table to a given font.

## Data structures

Structure	Description
<code>GUI_FONTINFO</code>	This structure is used when retrieving information about a font.
<code>GUI_TTF_CS</code>	
<code>GUI_TTF_DATA</code>	Contains the raw data of a TTF font file.

## Defines

Group of defines	Description
<code>Font info flags</code>	Flags that define the type of a font.
<code>SIF font types</code>	SIF font types to be used by <code>GUI_SIF_CreateFont()</code> .
<code>XBF font types</code>	XBF font types to be used by <code>GUI_XBF_CreateFont()</code> .

## Prototypes

Prototype	Description
<code>GUI_XBF_GET_DATA_FUNC</code>	A callback which is used for loading XBF files into RAM, e.g.

## 6.7.10.1 SIF file related font functions

### 6.7.10.1.1 GUI\_SIF\_CreateFont()

#### Description

Sets the font to be used by passing a pointer to system independent font data.

#### Prototype

```
void GUI_SIF_CreateFont(const void          * pFontData,
                       GUI_FONT           * pFont,
                       const GUI_SIF_TYPE * pFontType);
```

#### Parameters

Parameter	Description
<code>pFontData</code>	Pointer to the system independent font data.
<code>pFont</code>	Pointer to a <code>GUI_FONT</code> structure in RAM filled by the function.
<code>pFontType</code>	See a full list of available values under <i>SIF font types</i> on page 726.

#### Additional information

Contrary to the emWin standard fonts which must be compiled and linked with the application program, system independent fonts (SIF) are binary data blocks containing the font information. The Font Converter can be used to create system independent fonts. This tool is not part of the basic package. A short description follows later in this chapter. For details about how to create system independent fonts, refer to the chapter *Font Converter* on page 3136.

When using this function emWin needs to fill a `GUI_FONT` structure with the font information. The user needs to pass a pointer to this structure in the parameter `pFont`. The contents of this structure must remain valid during the use of the font. The function does not know what kind of font should be created. To tell the function the type of the font to be created it must be passed in the parameter `pFontType`. This has been done to avoid linkage of code which is not required.

#### Example

```
static GUI_FONT _Font; // Font structure in RAM

GUI_SIF_CreateFont(_DownloadedFont, &_Font, GUI_SIF_TYPE_PROP);
GUI_DispString("Hello World!");
```

### 6.7.10.1.2 GUI\_SIF\_DeleteFont()

#### Description

Deletes a font pointed by the parameter `pFont`.

#### Prototype

```
void GUI_SIF_DeleteFont(GUI_FONT * pFont);
```

#### Parameters

Parameter	Description
<code>pFont</code>	Pointer to the font to be deleted.

#### Additional information

After using a font created with `GUI_SIF_CreateFont()` the font should be deleted if not used anymore.

#### Example

```
static GUI_FONT _Font; // Font structure in RAM

GUI_SIF_CreateFont(_DownloadedFont, &_Font, GUI_SIF_TYPE_PROP);
//
// Use the font
//
GUI_SIF_DeleteFont(&_Font);
```



## 6.7.10.2 TTF file related functions

The emWin implementation of TTF file support is based on the FreeType font library from David Turner, Robert Wilhelm and Werner Lemberg. For details, refer to *TrueType Font (TTF) format* on page 662.

### 6.7.10.2.1 GUI\_TTF\_AddRowBottom()

#### Description

Adds or removes the given number of rows to/from the bottom edge of the TTF font.

#### Prototype

```
void GUI_TTF_AddRowBottom(GUI_FONT * pFont,  
                          int NumRows);
```

#### Parameters

Parameter	Description
<code>pFont</code>	<b>in/out</b> Pointer to a GUI_FONT structure which has been created using GUI_TTF_CreateFont().
<code>NumRows</code>	Number of rows to be added. If <code>NumRows</code> is negative, the amount will be removed.

### 6.7.10.2.2 GUI\_TTF\_AddRowTop()

#### Description

Adds or removes the given number of rows to/from the top edge of the TTF font.

#### Prototype

```
void GUI_TTF_AddRowTop(GUI_FONT * pFont,  
                       int NumRows);
```

#### Parameters

Parameter	Description
<code>pFont</code>	<code>in/out</code> Pointer to a <code>GUI_FONT</code> structure which has been created using <code>GUI_TTF_CreateFont()</code> .
<code>NumRows</code>	Number of rows to be added. If <code>NumRows</code> is negative, the amount will be removed.

### 6.7.10.2.3 GUI\_TTF\_CreateFont()

#### Description

Creates and selects an emWin font by using a TTF font file.

#### Prototype

```
int GUI_TTF_CreateFont(GUI_FONT * pFont,
                      GUI_TTF_CS * pCS);
```

#### Parameters

Parameter	Description
pFont	Pointer to a GUI_FONT structure in RAM filled by the function.
pCS	Pointer to a GUI_TTF_CS structure containing the creation parameters.

#### Return value

0        on success  
1        on error.

#### Additional information

When using the function the first time it initializes the TTF engine and the internal cache system. If the cache should use other values as defined per default it needs to be configured before the first call of this function. For details how to configure the cache, refer to GUI\_TTF\_SetCacheSize().

The internal data cache manages the complete mechanism of creating fonts and caching bitmap data. Font faces are uniquely identified from the cache by the address given in parameter pTTF and the parameter FaceIndex, which normally is 0. If the same font file for example should be used for creating fonts of different sizes the parameter pTTF should point to the same location of a GUI\_TTF\_DATA structure. The parameter PixelHeight specifies the height of the surrounding rectangle between the glyphs 'g' and 'f'. The value PixelHeight does not represent the offset between lines.

#### Example

```
GUI_TTF_CS  Cs0, Cs1;
GUI_TTF_DATA Data;
GUI_FONT    Font0, Font1;
//
// Set parameters for accessing the font file
//
Data.pData   = aTTF;           // Address
Data.NumBytes = sizeof(aTTF); // Size
//
// Set creation parameters of first font
//
Cs0.pTTF     = &Data;         // Use address of GUI_TTF_DATA
Cs0.PixelHeight = 24;         // Pixel height
Cs0.FaceIndex = 0;           // Initialize to 0
//
// Set creation parameters of second font
//
Cs1.pTTF     = &Data;         // Use address of GUI_TTF_DATA
Cs1.PixelHeight = 48;         // Pixel height
Cs1.FaceIndex = 0;           // Initialize to 0
//
// Create 2 fonts
//
GUI_TTF_CreateFont(&Font0, &Cs0);
```

```
GUI_TTF_CreateFont(&Font1, &Cs1);  
//  
// Draw something using the fonts  
//  
GUI_SetFont(&Font0);  
GUI_DispString("Hello world\n");  
GUI_SetFont(&Font1);  
GUI_DispString("Hello world");
```

### 6.7.10.2.4 GUI\_TTF\_CreateFontAA()

#### Description

Creates and selects an antialiased emWin font by using a TTF font file.

#### Prototype

```
int GUI_TTF_CreateFontAA(GUI_FONT * pFont,  
                        GUI_TTF_CS * pCS);
```

#### Parameters

Parameter	Description
pFont	Pointer to a GUI_FONT structure in RAM filled by the function.
pCS	Pointer to a GUI_TTF_CS structure containing the creation parameters.

#### Return value

0 on success  
1 on error.

### 6.7.10.2.5 GUI\_TTF\_EmboldenFont()

Before	After
The quick brown fox jumps over the lazy dog.	<b>The quick brown fox jumps over the lazy dog.</b>

#### Description

Renders the given TTF font as bold. An optimal strength for embolding is calculated using this formula:

$$\text{Embolding str. in px} = (2\frac{2}{3} * \text{Font size in pt}) / 64$$

To override the embolding strength, `GUI_TTF_EmboldenFontEx()` can be used.

#### Prototype

```
int GUI_TTF_EmboldenFont(GUI_FONT * pFont,
                        U8 Embolden);
```

#### Parameters

Parameter	Description
<code>pFont</code>	Pointer to a <code>GUI_FONT</code> structure which has been created using <code>GUI_TTF_CreateFont()</code> .
<code>Embolden</code>	1 for embolding the font, 0 for disabling.

#### Return value

0 On success.  
1 On error.

#### Additional information

Please note the following:

1. The TrueType engine transforms the glyphs of the font and therefore does not use a cache for rendering emboldened letters. This has an impact on performance compared to rendering TTF fonts with a cache.
2. It is recommended to call `GUI_SetTextMode(GUI_TM_TRANS);` before displaying an emboldened font because if the strength is too thick, characters could overlap.
3. This routine can also be called in conjunction with `GUI_TTF_ObliqueFont()` to create a bold oblique font.

### 6.7.10.2.6 GUI\_TTF\_EmboldenFontEx()

Before	After
The quick brown fox jumps over the lazy dog.	<b>The quick brown fox jumps over the lazy dog.</b>

#### Description

Renders the given TTF font as bold. A custom strength can be used for this which is expressed in the 26.6 fractional pixel format (1 unit = 1/64 pixel).

#### Prototype

```
int GUI_TTF_EmboldenFontEx(GUI_FONT * pFont,
                          I32      Strength);
```

#### Parameters

Parameter	Description
<code>pFont</code>	Pointer to a <code>GUI_FONT</code> structure which has been created using <code>GUI_TTF_CreateFont()</code> .
<code>Strength</code>	<code>Strength</code> for embolding used for X and Y in 26.6 fractional pixels (1 unit = 1/64 pixel), e.g.: 56 equals 0.875 pixels of added thickness. 0 disables embolding.

#### Return value

0        On success.  
1        On error.

#### Additional information

Negative strength values are also legal to make the font thinner.

Refer to `GUI_TTF_EmboldenFont()` for general notes on embolding TTF fonts.

For more information about the 26.6 fractional pixel format, please refer to the FreeType documentation.

### 6.7.10.2.7 GUI\_TTF\_EnableKerning()

Before	After
WAVE	WAVE

#### Description

Enables kerning (if possible).

#### Prototype

```
int GUI_TTF_EnableKerning(GUI_FONT * pFont,
                          int      OnOff);
```

#### Parameters

Parameter	Description
<code>pFont</code>	Pointer to a GUI_FONT structure which has been created using GUI_TTF_CreateFont().
<code>OnOff</code>	0 - Disables kerning 1 - Enables kerning



### 6.7.10.2.8 GUI\_TTF\_GetFamilyName()

#### Description

The function returns the font family name defined in the font file.

#### Prototype

```
int GUI_TTF_GetFamilyName(GUI_FONT * pFont,  
                           char * pBuffer,  
                           int NumBytes);
```

#### Parameters

Parameter	Description
<code>pFont</code>	Pointer to a GUI_FONT structure which has been created using GUI_TTF_CreateFont().
<code>pBuffer</code>	Buffer to be filled with the family name.
<code>NumBytes</code>	Size of buffer in bytes.

#### Return value

0 on success  
1 on error.

### 6.7.10.2.9 GUI\_TTF\_GetStyleName()

#### Description

The function returns the style name (bold, regular, ...) defined in the font file.

#### Prototype

```
int GUI_TTF_GetStyleName(GUI_FONT * pFont,  
                        char * pBuffer,  
                        int NumBytes);
```

#### Parameters

Parameter	Description
<code>pFont</code>	Pointer to a GUI_FONT structure which has been created using GUI_TTF_CreateFont().
<code>pBuffer</code>	Buffer to be filled with the style name.
<code>NumBytes</code>	Size of buffer in bytes.

#### Return value

0 on success  
1 on error.

### 6.7.10.2.10 GUI\_TTF\_ObliqueFont()

Before	After
The quick brown fox jumps over the lazy dog.	<i>The quick brown fox jumps over the lazy dog.</i>

#### Description

Renders the given TTF font as oblique. The letters of the font are slanted by an angle of 9.568° to the right.

#### Prototype

```
int GUI_TTF_ObliqueFont(GUI_FONT * pFont,
                       U8          Oblique);
```

#### Parameters

Parameter	Description
<code>pFont</code>	Pointer to a GUI_FONT structure which has been created using GUI_TTF_CreateFont().
<code>Oblique</code>	1 for obliquing the font, 0 for disabling.

#### Return value

0        On success.  
1        On error.

#### Additional information

Please note the following:

1. The TrueType engine transforms the glyphs of the font and therefore does not use a cache for rendering slanted letters. This has an impact on performance compared to rendering TTF fonts with a cache.
2. It is recommended to call `GUI_SetTextMode(GUI_TM_TRANS);` before displaying an obliqued font because if the angle is too high, characters could overlap.
3. This routine can also be called in conjunction with `GUI_TTF_EmboldenFont()` to create a bold oblique font.

### 6.7.10.2.11 GUI\_TTF\_ObliqueFontEx()

Before	After
The quick brown fox jumps over the lazy dog.	<i>The quick brown fox jumps over the lazy dog.</i>

#### Description

Renders the given TTF font as oblique. The letters of the font are slanted to the right by a given angle.

#### Prototype

```
int GUI_TTF_ObliqueFontEx(GUI_FONT * pFont,
                          I32      Angle);
```

#### Parameters

Parameter	Description
<code>pFont</code>	Pointer to a GUI_FONT structure which has been created using GUI_TTF_CreateFont().
<code>Angle</code>	<code>Angle * 1000</code> ( $10^\circ = 10000$ ). <code>Angle</code> must be between 1 and 45000 ( $0.001^\circ$ to $45^\circ$ ). If a 0 is passed, obliqueing is disabled for the font.

#### Return value

0        On success.  
1        On error.

#### Additional information

Note that the character width remains unchanged in order for the font to appear oblique. An angle too large means the font would be too wide to be displayed entirely.

Refer to GUI\_TTF\_ObliqueFont() for additional notes.

## 6.7.10.3 XBF file related font functions

### 6.7.10.3.1 GUI\_XBF\_CreateFont()

#### Description

Creates and selects a font by passing a pointer to a callback function, which is responsible for getting data from the XBF font file.

#### Prototype

```
int GUI_XBF_CreateFont(    GUI_FONT          * pFont,
                          GUI_XBF_DATA          * pXBF_Data,
                          const GUI_XBF_TYPE     * pFontType,
                          GUI_XBF_GET_DATA_FUNC * pfGetData,
                          void                   * pVoid);
```

#### Parameters

Parameter	Description
<code>pFont</code>	<b>out</b> Pointer to a <code>GUI_FONT</code> structure in RAM filled by the function.
<code>pXBF_Data</code>	<b>out</b> Pointer to a <code>GUI_XBF_DATA</code> structure in RAM filled by the function.
<code>pFontType</code>	<b>in</b> See a full list of available values under <i>XBF font types</i> on page 727.
<code>pfGetData</code>	<b>in</b> Function pointer to a <code>GetData</code> function. For more details, please refer to the chapter <i>FileAccess</i> on page 3219.
<code>pVoid</code>	<b>in</b> Application defined pointer passed to the 'GetData' callback function.

#### Return value

0        on success  
1        if font creation fails.

#### Additional information

The function requires pointers to a `GUI_FONT` structure and a `GUI_XBF_DATA` structure. The function will fill these structures with font information. It is required, that the contents of these structures remain valid during the usage of the font.

The function does not know what kind of XBF font has to be created, so the parameter `pFontType` has to be used to tell the function the type of the font to be created. This has been done to avoid unnecessary linkage of code.

The maximum number of data bytes per character is limited to 200 per default. If the number of characters exceed this limit banding is used to display the remaining characters. This should cover the most requirements. If loading a character with more bytes a warning will be generated in the debug version. The default value can be increased by adding the following define to the file `GUIConf.h`:

```
#define GUI_MAX_XBF_BYTES 500 // Sets the maximum number of bytes/chars to 500
```

### 6.7.10.3.2 GUI\_XBF\_DeleteFont()

#### Description

Deletes an XBF font pointed by the parameter `pFont`.

#### Prototype

```
void GUI_XBF_DeleteFont(GUI_FONT * pFont);
```

#### Parameters

Parameter	Description
<code>pFont</code>	Pointer to the font to be deleted.

#### Additional information

After using a font created with `GUI_XBF_CreateFont()` the font should be deleted if not used anymore.

## 6.7.10.4 BDF file related font functions

### 6.7.10.4.1 GUI\_BDF\_CreateFont()

#### Description

Creates and selects an emWin font by using a BDF font file.

#### Prototype

```
int GUI_BDF_CreateFont(      GUI_FONT * pFont,
                           const U8    * pData,
                           U32          Size);
```

#### Parameters

Parameter	Description
<a href="#">pFont</a>	Pointer to a GUI_FONT structure in RAM filled by the function.
<a href="#">pData</a>	Pointer to data buffer that contains the BDF font file.
<a href="#">Size</a>	<a href="#">Size</a> of the data buffer.

#### Return value

0        Success.  
1        Error.

#### Additional information

When using the function the first time it initializes the TTF engine. The routine `GUI_BDF_DeleteFont()` deletes a font. By calling `GUI_BDF_Done()` all memory allocated by the TTF engine will be deleted.

#### 6.7.10.4.2 GUI\_BDF\_DeleteFont()

##### Description

Frees all allocated memory for an emWin font created from a BDF font file.

##### Prototype

```
int GUI_BDF_DeleteFont(GUI_FONT * pFont);
```

##### Parameters

Parameter	Description
<code>pFont</code>	Pointer to font.

##### Return value

- 0 Font was successfully deleted.
- 1 Error when deleting the font.

##### Additional information

To free all memory allocated by the TTF engine, call `GUI_FT_Done()`.



### 6.7.10.4.3 GUI\_BDF\_EmboldenFont()

#### Description

Renders the given BDF font as bold.

#### Prototype

```
int GUI_BDF_EmboldenFont(GUI_FONT * pFont,  
                        U8 Embolden);
```

#### Parameters

Parameter	Description
<code>pFont</code>	Pointer to a GUI_FONT structure which has been created using GUI_BDF_CreateFont().
<code>Embolden</code>	1 for embolding the font, 0 for disabling.

#### Return value

0 On success.  
1 On error.

#### 6.7.10.4.4 GUI\_BDF\_EmboldenFontEx()

##### Description

Renders the given BDF font as bold. A custom strength can be used for this which is expressed in the 26.6 fractional pixel format (1 unit = 1/64 pixel).

##### Prototype

```
int GUI_BDF_EmboldenFontEx(GUI_FONT * pFont,  
                           I32      Strength);
```

##### Parameters

Parameter	Description
<code>pFont</code>	Pointer to a <code>GUI_FONT</code> structure which has been created using <code>GUI_BDF_CreateFont()</code> .
<code>Strength</code>	<code>Strength</code> for embolding used for X and Y in 26.6 fractional pixels. 0 disables embolding.

##### Return value

0        On success.  
1        On error.

##### Additional information

For more information about the 26.6 fractional pixel format, please refer to the FreeType documentation.

#### 6.7.10.4.5 GUI\_BDF\_GetFamilyName()

##### Description

The function returns the font family name defined in the font file.

##### Prototype

```
int GUI_BDF_GetFamilyName(GUI_FONT * pFont,  
                           char * pBuffer,  
                           int NumBytes);
```

##### Parameters

Parameter	Description
<code>pFont</code>	Pointer to a GUI_FONT structure which has been created using GUI_BDF_CreateFont().
<code>pBuffer</code>	Buffer to be filled with the family name.
<code>NumBytes</code>	Size of buffer in bytes.

##### Return value

0 on success  
1 on error.

#### 6.7.10.4.6 GUI\_BDF\_GetStyleName()

##### Description

The function returns the style name (bold, regular, ...) defined in the font file.

##### Prototype

```
int GUI_BDF_GetStyleName(GUI_FONT * pFont,
                        char * pBuffer,
                        int NumBytes);
```

##### Parameters

Parameter	Description
<code>pFont</code>	Pointer to a GUI_FONT structure which has been created using GUI_BDF_CreateFont().
<code>pBuffer</code>	Buffer to be filled with the style name.
<code>NumBytes</code>	Size of buffer in bytes.

##### Return value

0 on success  
1 on error.

#### 6.7.10.4.7 GUI\_BDF\_SetLetterSpacing()

##### Description

Sets a spacing that is added/subtracted to each letter of the font. The value is added to the characters cursor distance. The new cursor distance cannot be negative.

##### Prototype

```
int GUI_BDF_SetLetterSpacing(GUI_FONT * pFont,  
                             int      Spacing);
```

##### Parameters

Parameter	Description
<code>pFont</code>	Pointer to a GUI_FONT structure which has been created using GUI_BDF_CreateFont().
<code>Spacing</code>	Absolute spacing in pixels to be added to each character (can also be negative).

##### Return value

Old spacing value.

## 6.7.10.5 FreeType related font functions

### 6.7.10.5.1 GUI\_FT\_DestroyCache()

#### Description

This function frees all memory allocated by the FreeType cache system and destroys the cache.

#### Prototype

```
void GUI_FT_DestroyCache(void);
```

#### Additional information

The next time `GUI_TTF_CreateFont()` or `GUI_BDF_CreateFont()` is used, emWin automatically creates and initializes a new cache.

### 6.7.10.5.2 GUI\_FT\_Done()

#### Description

This function frees all memory allocated by the FreeType engine and its internal cache system.

#### Prototype

```
void GUI_FT_Done(void);
```

#### Additional information

The next time `GUI_TTF_CreateFont()` or `GUI_BDF_CreateFont()` is used, emWin automatically initializes the TTF engine and creates and initializes a new cache.

### 6.7.10.5.3 GUI\_FT\_GetMeasurementChars()

#### Description

Returns the characters that are used for measuring the font metrics of newly created TTF and BDF fonts.

#### Prototype

```
void GUI_FT_GetMeasurementChars(U16 * pLowerHeight,  
                                U16 * pUpperHeight);
```

#### Parameters

Parameter	Description
<code>pLowerHeight</code>	Pointer to an U16 to store the character used to measure the height of a lower case letter.
<code>pUpperHeight</code>	Pointer to an U16 to store the character used to measure the height of an upper case letter.



### 6.7.10.5.4 GUI\_FT\_SetCacheSize()

#### Description

Sets the size parameters used to create the cache on the first call of `GUI_TTF_CreateFont()` or `GUI_BDF_CreateFont()`.

#### Prototype

```
void GUI_FT_SetCacheSize(unsigned MaxFaces,
                        unsigned MaxSizes,
                        U32      MaxBytes);
```

#### Parameters

Parameter	Description
<code>MaxFaces</code>	Maximum number of font faces the cache should be able to handle simultaneously. 0 selects default value.
<code>MaxSizes</code>	Maximum number of size objects the cache should be able to handle simultaneously. 0 selects default value.
<code>MaxBytes</code>	Maximum number of bytes used for the bitmap cache. 0 selects default value.

#### Return value

0        on success  
1        on error.

#### Additional information

If for example 3 font faces should be used, each with 2 sizes, the cache should be able to manage 6 size objects. The default values used by the TTF engine are: 2 faces, 4 size objects and 200K of bitmap data cache.

### 6.7.10.5.5 GUI\_FT\_SetMeasurementChars()

#### Description

Sets the characters that are used for measuring the font metrics of newly created TTF and BDF fonts.

The default characters are:

- Character for lower case height: **g**
- Character for upper case height: **M**

It makes sense to change the measurement characters if the BDF or TTF fonts that are used do not contain the default characters.

#### Prototype

```
void GUI_FT_SetMeasurementChars(U16 LowerHeight,  
                                U16 UpperHeight);
```

#### Parameters

Parameter	Description
<a href="#">LowerHeight</a>	Character for measuring the height of lower case letters
<a href="#">UpperHeight</a>	Character for measuring the height of upper case letters.

#### Additional information

The set characters are used for all TTF and BDF fonts that are created afterwards.

## 6.7.10.6 Common font-related functions

### 6.7.10.6.1 GUI\_GetCharDistX()

#### Description

Returns the width in pixels (X-size) used to display a specified character in the currently selected font.

#### Prototype

```
int GUI_GetCharDistX(U16 c);
```

#### Parameters

Parameter	Description
c	Character to calculate width from.

### 6.7.10.6.2 GUI\_GetDefaultFont()

#### Description

Returns the default currently set default font.

#### Prototype

```
GUI_FONT *GUI_GetDefaultFont(void);
```

#### Return value

This function returns a pointer to the currently set default font.

### 6.7.10.6.3 GUI\_GetFallbackFont()

#### Description

Returns a font which contains the given character.

#### Prototype

```
GUI_FONT *GUI_GetFallbackFont(U16 c);
```

#### Parameters

Parameter	Description
c	Character which needs to be within the font.

#### Return value

Returns a pointer to a fallback font.

#### Additional information

This function requires a fallback font set or callback function to retrieve a fallback font. Please refer to `GUI_SetFuncGetFallbackFont()` and `GUI_SetFallbackFont()`.

#### 6.7.10.6.4 GUI\_GetFont()

##### Description

Returns a pointer to the currently selected font.

##### Prototype

```
GUI_FONT *GUI_GetFont(void);
```

##### Return value

This function returns a pointer to the currently selected font.

### 6.7.10.6.5 GUI\_GetFontDistY()

#### Description

Returns the Y-spacing of the currently selected font.

#### Prototype

```
int GUI_GetFontDistY(void);
```

#### Return value

This function returns the Y-spacing of the currently selected font.

#### Additional information

The Y-spacing is the vertical distance in pixels between two adjacent lines of text. The returned value is the YDist value of the entry for the currently selected font. The returned value is valid for both proportional and monospaced fonts.

### 6.7.10.6.6 GUI\_GetFontInfo()

#### Description

Calculates a pointer to a GUI\_FONTINFO structure of a particular font.

#### Prototype

```
void GUI_GetFontInfo(const GUI_FONT      * pFont,  
                    GUI_FONTINFO * pFontInfo);
```

#### Parameters

Parameter	Description
<code>pFont</code>	Pointer to the font.
<code>pFontInfo</code>	Pointer to a GUI_FONTINFO structure.

#### Example

Gets the info of GUI\_Font6x8. After the calculation `FontInfo.Flags` contains the flag `GUI_FONTINFO_FLAG_MONO`.

```
GUI_FONTINFO FontInfo;  
GUI_GetFontInfo(&GUI_Font6x8, &FontInfo);
```



### 6.7.10.6.7 GUI\_GetFontSizeY()

#### Description

Returns the height in pixels (Y-size) of the currently selected font.

#### Prototype

```
int GUI_GetFontSizeY(void);
```

#### Return value

Size of the currently selected font in pixels.

#### Additional information

The returned value is the YSize value of the entry for the currently selected font. This value is less than or equal to the Y-spacing returned by the function `GUI_GetFontDistY()`. The returned value is valid for both proportional and monospaced fonts.

### 6.7.10.6.8 GUI\_GetLeadingBlankCols()

#### Description

Returns the number of leading blank pixel columns in the currently selected font for the given character.

#### Prototype

```
int GUI_GetLeadingBlankCols(U16 c);
```

#### Parameters

Parameter	Description
c	Character to be used.

#### Return value

- ≠ -1 Number of leading blank pixel columns in the currently selected font for the given character.
- = -1 On error.

#### Example

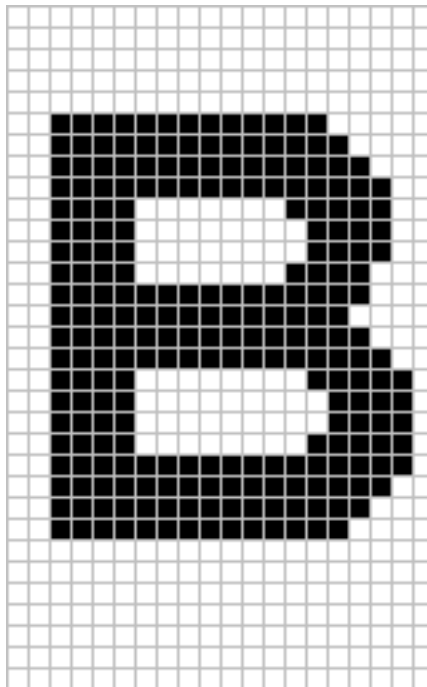

The result for the character 'B' shown in the screenshot above would be 2.

### 6.7.10.6.9 GUI\_GetLeadingBlankRows()

#### Description

Returns the number of leading blank pixel rows in the currently selected font for the given character.

#### Prototype

```
int GUI_GetLeadingBlankRows(U16 c);
```

#### Parameters

Parameter	Description
c	Character to be used.

#### Return value

- ≠ -1 Number of leading blank pixel columns in the currently selected font for the given character.
- = -1 On error.

#### Additional information

Please note that only EXT fonts support that function.

#### Example

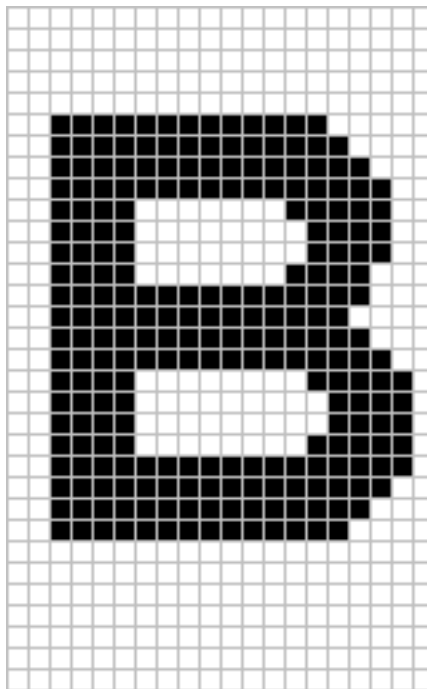

The result for the character 'B' shown in the screenshot above would be 5.

### 6.7.10.6.10 GUI\_GetStringDistX()

#### Description

Returns the X-size used to display a specified string in the currently selected font.

#### Prototype

```
int GUI_GetStringDistX(const char * s);
```

#### Parameters

Parameter	Description
s	Pointer to the string.

#### Return value

≠ -1 X-size used to display a specified string in the currently selected font.  
= -1 Error.

### 6.7.10.6.11 GUI\_GetStringDistXEx()

#### Description

Returns the X-size used to display a number of characters of a string in the currently selected font.

#### Prototype

```
int GUI_GetStringDistXEx(const char * s,  
                        int n);
```

#### Parameters

Parameter	Description
<code>s</code>	Pointer to the string.
<code>n</code>	Number of characters counted from the beginning.

#### Return value

≠ -1 X-size used to display a specified string in the currently selected font.  
= -1 Error.

### 6.7.10.6.12 GUI\_GetTextExtend()

#### Description

Calculates the text rectangle for drawing the given string. The rectangle is calculated based on the currently set font and position.

#### Prototype

```
void GUI_GetTextExtend(    GUI_RECT * pRect ,
                          const char * s ,
                          int      MaxNumChars );
```

#### Parameters

Parameter	Description
<code>pRect</code>	Pointer to GUI_RECT-structure to store result.
<code>s</code>	Pointer to the string.
<code>Len</code>	Number of characters of the string.

### 6.7.10.6.13 GUI\_GetTrailingBlankCols()

#### Description

Returns the number of trailing blank pixel columns in the currently selected font for the given character.

#### Prototype

```
int GUI_GetTrailingBlankCols(U16 c);
```

#### Parameters

Parameter	Description
c	Character to be used.

#### Return value

- ≠ -1 Number of trailing blank pixel columns in the currently selected font for the given character.
- = -1 On error.

#### Example

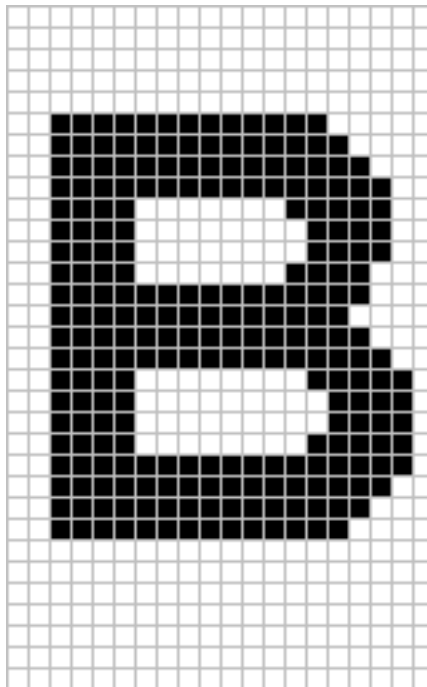

The result for the character 'B' shown in the screenshot above would be 1.

### 6.7.10.6.14 GUI\_GetTrailingBlankRows()

#### Description

Returns the number of trailing blank pixel rows in the currently selected font for the given character.

#### Prototype

```
int GUI_GetTrailingBlankRows(U16 c);
```

#### Parameters

Parameter	Description
c	Character to be used.

#### Return value

- ≠ -1 Number of trailing blank pixel columns in the currently selected font for the given character.
- = -1 On error.

#### Additional information

Please note that only EXT fonts support that function.

#### Example

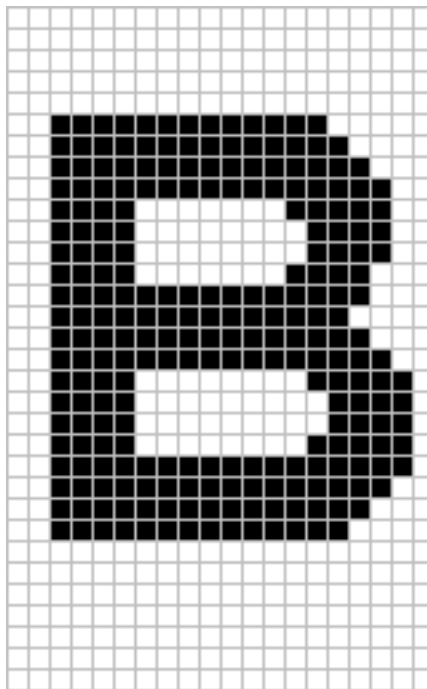

The result for the character 'B' shown in the screenshot above would be 7.



### 6.7.10.6.15 GUI\_GetYDistOfFont()

#### Description

Returns the Y-spacing of a particular font.

#### Prototype

```
int GUI_GetYDistOfFont(const GUI_FONT * pFont);
```

#### Parameters

Parameter	Description
<code>pFont</code>	Pointer to the font.

#### Return value

Y-spacing of the font.

#### Additional information

Please refer to `GUI_GetFontDistY()`.

### 6.7.10.6.16 GUI\_GetYSizeOfFont()

#### Description

Returns the Y-size of a particular font.

#### Prototype

```
int GUI_GetYSizeOfFont(const GUI_FONT * pFont);
```

#### Parameters

Parameter	Description
<code>pFont</code>	Pointer to the font.

#### Return value

Y-size of the font.

#### Additional information

Additional information can be found in the description of `GUI_GetFontSizeY()`.

### 6.7.10.6.17 GUI\_IsInFont()

#### Description

Evaluates whether a particular font contains a specified character or not.

#### Prototype

```
char GUI_IsInFont(const GUI_FONT * pFont,  
                 U16          c);
```

#### Parameters

Parameter	Description
<code>pFont</code>	Pointer to the font.
<code>c</code>	Character to be searched for.

#### Return value

- 1 if the character was found.
- 0 if the character was not found.

#### Additional information

If the pointer `pFont` is set to 0, the currently selected font is used.

#### Example

Evaluates whether the font `GUI_FontD32` contains an "X":

```
if (GUI_IsInFont(&GUI_FontD32, 'X') == 0) {  
    GUI_DispString("GUI_FontD32 does not contain 'X'");  
}
```

### 6.7.10.6.18 GUI\_SetDefaultFont()

#### Description

Sets the font to be used by default for text output.

#### Prototype

```
void GUI_SetDefaultFont(const GUI_FONT * pFont);
```

#### Parameters

Parameter	Description
<code>pFont</code>	Pointer to the font to be selected as default

#### Additional information

This function is intended to be used in `GUI_X_Config()`. Defining `GUI_DEFAULT_FONT` is not mandatory anymore. If there is neither defined `GUI_DEFAULT_FONT` nor `GUI_SetDefaultFont` is called, `GUI_Font6x8` will be set as the default Font. If none of the emWin fonts shall be used, `GUI_DEFAULT_FONT` has to be defined by `NULL` and a custom font needs to be set as default with this function.

### 6.7.10.6.19 GUI\_SetFallbackFont()

#### Description

Sets a fallback font which is used if the default font does not contain the required characters.

#### Prototype

```
GUI_FONT *GUI_SetFallbackFont(const GUI_FONT * pNewFont);
```

#### Parameters

Parameter	Description
<code>pFont</code>	Pointer to the font to be used.

#### Return value

Returns a pointer to the previously set font.

### 6.7.10.6.20 GUI\_SetFont()

#### Description

Sets the font to be used for text output.

#### Prototype

```
GUI_FONT *GUI_SetFont(const GUI_FONT * pNewFont);
```

#### Parameters

Parameter	Description
pFont	Pointer to the font to be selected and used.

#### Return value

Returns a pointer to the previously selected font so that it may be buffered.

#### Example

Displays example text in 3 different sizes, restoring the former font afterwards:

```
const GUI_FONT GUI_FLASH * OldFont;
OldFont = GUI_SetFont(&GUI_Font8x16);           // Buffer old font
GUI_DispStringAt("This text is 8 by 16 pixels", 0, 0);
GUI_SetFont(&GUI_Font6x8);
GUI_DispStringAt("This text is 6 by 8 pixels", 0, 20);
GUI_SetFont(&GUI_Font8);
GUI_DispStringAt("This text is proportional", 0, 40);
GUI_SetFont(OldFont);                           // Restore old font
```

#### Screenshot of above example

```

This text is 8 by 16 pixels
This text is 6 by 8 pixels
This text is proportional

```

#### Example

Displays text and value in different fonts:

```
GUI_SetFont(&GUI_Font6x8);
GUI_DispString("The result is: "); // Disp text
GUI_SetFont(&GUI_Font8x8);
GUI_DispDec(42, 2);                // Disp value
```

#### Screenshot of above example

```
The result is: 42
```

### 6.7.10.6.21 GUI\_SetFuncGetFallbackFont()

#### Description

Sets a callback function which is called to retrieve a fallback font.

#### Prototype

```
void GUI_SetFuncGetFallbackFont(const GUI_FONT * ( *pfcgGetFallbackFont)(U16 c ));
```

#### Parameters

Parameter	Description
<code>pfcgGetFallbackFont</code>	Pointer to the callback function

## 6.7.10.7 Kerning related functions

### 6.7.10.7.1 GUI\_AttachKerning()

#### Description

Attaches a given kerning table to a given font. After calling this function, kerning is enabled for the font `pFont`.

#### Prototype

```
void GUI_AttachKerning(const GUI_FONT          * pFont,
                     GUI_KERNING_INFO * pInfo,
                     const U16          * pData,
                     U32                NumItems);
```

#### Parameters

Parameter	Description
<code>pFont</code>	<b>in</b> Font to be used with kerning.
<code>pInfo</code>	<b>out</b> Pointer to a <code>GUI_KERNING_INFO</code> structure which should remain valid during the font is in use.
<code>pData</code>	<b>in</b> Pointer to the kerning table.
<code>NumItems</code>	Number of kerning pairs.

#### Additional information

Please note that the `GUI_KERNING_INFO` structure should not stay on stack because it should remain valid during the font is in use.



### 6.7.10.7.2 GUI\_DetachKerning()

#### Description

Detaches a given kerning table to a given font. After calling this function, kerning is disabled for the font `pFont`.

#### Prototype

```
int GUI_DetachKerning(const GUI_FONT * pFont);
```

#### Parameters

Parameter	Description
<code>pFont</code>	<code>in</code> Font to detach a kerning table from.

#### Return value

0 On success.  
1 On error.

## 6.7.10.8 Data structures

### 6.7.10.8.1 GUI\_FONTINFO

#### Description

This structure is used when retrieving information about a font.

#### Type definition

```
typedef struct {  
    U16  Flags;  
    U8   Baseline;  
    U8   LHeight;  
    U8   CHeight;  
} GUI_FONTINFO;
```

#### Structure members

Member	Description
<a href="#">Flags</a>	<a href="#">Flags</a> that define the type of the font. Permitted values are explained in <i>Font info flags</i> on page 725.
<a href="#">Baseline</a>	Height of the baseline. The baseline is the line where most, but not all characters are 'placed on'. The lowest part of an 'A' is on the baseline.
<a href="#">LHeight</a>	Height of a lower case character such as 'a' or 'x'.
<a href="#">CHeight</a>	Height of an upper case character such as 'A' or 'X'.

#### See also

- `GUI_GetFontInfo()`

### 6.7.10.8.2 GUI\_TTF\_CS

#### Type definition

```
typedef struct {
    GUI_TTF_DATA * pTTF;
    U32             aImageTypeBuffer[];
    int            PixelHeight;
    int            FaceIndex;
    I32            BoldStrength;
    I32            aObliqueMatrix[];
    U8             EmFlags;
} GUI_TTF_CS;
```

#### Structure members

Member	Description
<code>pTTF</code>	Pointer to GUI_TTF_DATA structure which contains location and size of font file.
<code>aImageTypeBuffer</code>	Internal use.
<code>PixelHeight</code>	Pixel height of new font. It means the height of the surrounding rectangle between the glyphs 'g' and 'f'. Please notice that it is not the distance between two lines of text. With other words the value returned by GUI_GetFontSizeY() is not identically with this value.
<code>FaceIndex</code>	Some font files can contain more than one font face. In case of more than one face this index specifies the zero based face index to be used to create the font. Usually 0.
<code>BoldStrength</code>	Internal use.
<code>aObliqueMatrix</code>	Internal use.
<code>EmFlags</code>	Internal use.

#### See also

- GUI\_TTF\_CreateFont()
- GUI\_TTF\_CreateFontAA()

### 6.7.10.8.3 GUI\_TTF\_DATA

#### Description

Contains the raw data of a TTF font file.

#### Type definition

```
typedef struct {  
    const void * pData;  
    U32          NumBytes;  
} GUI_TTF_DATA;
```

#### Structure members

Member	Description
<a href="#">pData</a>	Pointer to TTF font file in addressable memory area.
<a href="#">NumBytes</a>	Size of file in bytes.

#### See also

- [GUI\\_TTF\\_CreateFont\(\)](#)

## 6.7.10.9 Defines

### 6.7.10.9.1 Font info flags

#### Description

These flags define of what type a font is. See the chapter *Font types* on page 657 for a detailed explanation of the font types.

#### Definition

```
#define GUI_FONTINFO_FLAG_PROP      (1 << 0)
#define GUI_FONTINFO_FLAG_MONO     (1 << 1)
#define GUI_FONTINFO_FLAG_AA       (1 << 2)
#define GUI_FONTINFO_FLAG_AA2     (1 << 3)
#define GUI_FONTINFO_FLAG_AA4     (1 << 4)
#define GUI_FONTINFO_FLAG_PROPFPM (1 << 5)
```

#### Symbols

Definition	Description
<a href="#">GUI_FONTINFO_FLAG_PROP</a>	Font is proportional.
<a href="#">GUI_FONTINFO_FLAG_MONO</a>	Font is monospaced.
<a href="#">GUI_FONTINFO_FLAG_AA</a>	Font is an antialiased font.
<a href="#">GUI_FONTINFO_FLAG_AA2</a>	Font is an antialiased font with 2bpp anti-aliasing.
<a href="#">GUI_FONTINFO_FLAG_AA4</a>	Font is an antialiased font with 4bpp anti-aliasing.
<a href="#">GUI_FONTINFO_FLAG_PROPFPM</a>	Font is proportional and framed.

### 6.7.10.9.2 SIF font types

#### Description

Available font type defines to be used by the `pFontType` parameter in function `GUI_SIF_CreateFont()`.

#### Definition

```
#define GUI_SIF_TYPE_PROP_LEG           GUI_SIF_TYPE_PROP
#define GUI_SIF_TYPE_PROP_LEG_AA2     GUI_SIF_TYPE_PROP_AA2
#define GUI_SIF_TYPE_PROP_LEG_AA4     GUI_SIF_TYPE_PROP_AA4
#define GUI_SIF_TYPE_PROP_FRM         &GUI_SIF_APIList_Prop_Frm
#define GUI_SIF_TYPE_PROP_STD         GUI_SIF_TYPE_PROP_EXT
#define GUI_SIF_TYPE_PROP_STD_AA2     GUI_SIF_TYPE_PROP_AA2_EXT
#define GUI_SIF_TYPE_PROP_STD_AA4     GUI_SIF_TYPE_PROP_AA4_EXT
```

#### Symbols

Definition	Description
<code>GUI_SIF_TYPE_PROP_LEG</code>	Should be used if the parameter <code>pFont</code> points to a legacy proportional font.
<code>GUI_SIF_TYPE_PROP_LEG_AA2</code>	Should be used if the parameter <code>pFont</code> points to a legacy proportional font that uses 2bpp anti-aliasing.
<code>GUI_SIF_TYPE_PROP_LEG_AA4</code>	Should be used if the parameter <code>pFont</code> points to a legacy proportional font that uses 4bpp anti-aliasing.
<code>GUI_SIF_TYPE_PROP_FRM</code>	Should be used if the parameter <code>pFont</code> points to a standard proportional framed font.
<code>GUI_SIF_TYPE_PROP_STD</code>	Should be used if the parameter <code>pFont</code> points to a standard proportional font.
<code>GUI_SIF_TYPE_PROP_STD_AA2</code>	Should be used if the parameter <code>pFont</code> points to a standard proportional font that uses 2bpp anti-aliasing.
<code>GUI_SIF_TYPE_PROP_STD_AA4</code>	Should be used if the parameter <code>pFont</code> points to a standard proportional font that uses 4bpp anti-aliasing.

### 6.7.10.9.3 XBF font types

#### Description

Available font type defines to be used by the `pFontType` parameter in function `GUI_XBF_CreateFont()`.

#### Definition

```
#define GUI_XBF_TYPE_PROP_LEG      GUI_XBF_TYPE_PROP
#define GUI_XBF_TYPE_PROP_FRM     &GUI_XBF_APIList_Prop_Frm
#define GUI_XBF_TYPE_PROP_STD     GUI_XBF_TYPE_PROP_EXT
#define GUI_XBF_TYPE_PROP_STD_AA2 GUI_XBF_TYPE_PROP_AA2_EXT
#define GUI_XBF_TYPE_PROP_STD_AA4 GUI_XBF_TYPE_PROP_AA4_EXT
```

#### Symbols

Definition	Description
<code>GUI_XBF_TYPE_PROP_LEG</code>	Should be used if the parameter <code>pFont</code> points to a legacy proportional font.
<code>GUI_XBF_TYPE_PROP_FRM</code>	Should be used if the parameter <code>pFont</code> points to a standard proportional font.
<code>GUI_XBF_TYPE_PROP_STD</code>	Should be used if the parameter <code>pFont</code> points to a standard framed proportional font.
<code>GUI_XBF_TYPE_PROP_STD_AA2</code>	Should be used if the parameter <code>pFont</code> points to a standard proportional font that uses 2bpp anti-aliasing.
<code>GUI_XBF_TYPE_PROP_STD_AA4</code>	Should be used if the parameter <code>pFont</code> points to a standard proportional font that uses 4bpp anti-aliasing.

## 6.7.10.10 Prototypes

### 6.7.10.10.1 GUI\_XBF\_GET\_DATA\_FUNC

#### Description

A callback which is used for loading XBF files into RAM, e.g. from a file system.

For more details about GetData functions in general, please refer to the chapter *FileAccess* on page 3219.

#### Type definition

```
typedef int GUI_XBF_GET_DATA_FUNC(U32    Off,
                                  U16    NumBytes,
                                  void * pVoid,
                                  void * pBuffer);
```

#### Parameters

Parameter	Description
<code>Off</code>	Current byte offset in the file.
<code>NumBytes</code>	Number of bytes to be read.
<code>pVoid</code>	<b>in</b> Parameter is passed to the callback function when requesting font data. It can be used for example to pass a file handle to the callback function.
<code>pBuffer</code>	<b>in</b> Pointer to a preallocated buffer where the read file data should be written to.

#### Return value

0        On success.  
1        On error.

#### Example

```
static GUI_FONT    Font;      // GUI_FONT structure in RAM
static GUI_XBF_DATA XBF_Data; // GUI_XBF_DATA structure in RAM
static int _cbGetData(U32 Off, U16 NumBytes, void * pVoid, void * pBuffer) {
    //
    // The pVoid pointer may be used to get a file handle
    //
    ...// TBD
    //
    // Set file pointer to the given position
    //
    ...// TBD
    //
    // Read the required number of bytes into the given buffer
    //
    ...// TBD
    //
    // Return 0 on success. Return 1 if the function fails.
    //
}
GUI_XBF_CreateFont(&Font, &XBF_Data, GUI_XBF_TYPE_PROP, _cbGetData, pVoid);
```



## 6.7.11 Character sets

### 6.7.11.1 ASCII

emWin supports the full set of ASCII characters. These are the following 96 characters from 32 to 127:

Hex	0	1	2	3	4	5	6	7	8	9	A	B	C	D	E	F
2x		!	"	#	\$	%	&	'	(	)	*	+	,	-	.	/
3x	0	1	2	3	4	5	6	7	8	9	:	;	<	=	>	?
4x	@	A	B	C	D	E	F	G	H	I	J	K	L	M	N	O
5x	P	Q	R	S	T	U	V	W	X	Y	Z	[	\	]	^	_
6x	`	a	b	c	d	e	f	g	h	i	j	k	l	m	n	o
7x	p	q	r	s	t	u	v	w	x	y	z	{		}	~	

Unfortunately, as ASCII stands for American Standard Code for Information Interchange, it is designed for American needs. It does not include any of the special characters used in European languages, such as Ä, Ö, Ü, á, à, and others. There is no single standard for these "European extensions" of the ASCII set of characters—several different ones exist. The one used on the Internet and by most Windows programs is ISO 8859-1, a superset of the ASCII set of characters.

### 6.7.11.2 ISO 8859-1 Western Latin character set

emWin supports the ISO 8859-1, which defines characters as listed below:

Code	Description	Char
160	Non-breaking space	
161	Inverted exclamation mark	¡
162	Cent sign	¢
163	Pound sign	£
164	Currency sign	₣
165	Yen sign	¥
166	Broken bar	¦
167	Section sign	§
168	Diaeresis (Umlaut)	¨
169	Copyright sign	©
170	Feminine Ordinal Indicator	ª
171	Left-pointing double angle quotation mark (Guillemet)	«
172	Not sign	¬
173	Soft hyphen	
174	Registered sign	®
175	Macron accent	¯
176	Degree symbol	°
177	Plus-minus sign	±
178	Superscript two	²
179	Superscript three	³
180	Acute accent	´
181	Micro sign	µ
182	Pilcrow sign	¶

Code	Description	Char
183	Middle dot	·
184	Cedilla	¸
185	Superscript one	¹
186	Masculine ordinal indicator	º
187	Right-pointing double angle quotation mark (Guillemet)	»
188	Vulgar fraction one quarter	¼
189	Vulgar fraction one half	½
190	Vulgar fraction three quarters	¾
191	Inverted Question Mark	¿
192	Latin Capital Letter A with grave	À
193	Latin Capital letter A with acute	Á
194	Latin Capital letter A with circumflex	Â
195	Latin Capital letter A with tilde	Ã
196	Latin Capital letter A with diaeresis	Ä
197	Latin Capital letter A with ring above	Å
198	Latin Capital letter Æ	Æ
199	Latin Capital letter C with cedilla	Ç
200	Latin Capital letter E with grave	È
201	Latin Capital letter E with acute	É
202	Latin Capital letter E with circumflex	Ê
203	Latin Capital letter E with diaeresis	Ë
204	Latin Capital letter I with grave	Ì
205	Latin Capital letter I with acute	Í
206	Latin Capital letter I with circumflex	Î
207	Latin Capital letter I with diaeresis	Ï
208	Latin Capital letter Eth	Ð
209	Latin Capital letter N with tilde	Ñ
210	Latin Capital letter O with grave	Ò
211	Latin Capital letter O with acute	Ó
212	Latin Capital letter O with circumflex	Ô
213	Latin Capital letter O with tilde	Õ
214	Latin Capital letter O with diaeresis	Ö
215	Multiplication sign	×
216	Latin Capital letter O with stroke	Ø
217	Latin Capital letter U with grave	Ù
218	Latin Capital letter U with acute	Ú
219	Latin Capital Letter U with circumflex	Û
220	Latin Capital Letter U with diaeresis	Ü
221	Latin Capital Letter Y with acute	Ý
222	Latin Capital Letter Thorn	þ
223	Latin Small Letter sharp S	ß
224	Latin Small Letter A with grave	à
225	Latin Small Letter A with acute	á

Code	Description	Char
226	Latin Small Letter A with circumflex	â
227	Latin Small Letter A with tilde	ã
228	Latin Small Letter A with diaeresis	ä
229	Latin Small Letter A with ring above	å
230	Latin Small Letter Æ	æ
231	Latin Small Letter C with cedilla	ç
232	Latin Small Letter E with grave	è
233	Latin Small Letter E with acute	é
234	Latin Small Letter E with circumflex	ê
235	Latin Small Letter E with diaeresis	ë
236	Latin Small Letter I with grave	ì
237	Latin Small Letter I with acute	í
238	Latin Small Letter I with circumflex	î
239	Latin Small Letter I with diaeresis	ï
240	Latin Small Letter Eth	ð
241	Latin Small Letter N with tilde	ñ
242	Latin Small Letter O with grave	ò
243	Latin Small Letter O with acute	ó
244	Latin Small Letter O with circumflex	ô
245	Latin Small Letter O with tilde	õ
246	Latin Small Letter O with diaeresis	ö
247	Division sign	÷
248	Latin Small Letter O with stroke	ø
249	Latin Small Letter U with grave	ù
250	Latin Small Letter U with acute	ú
251	Latin Small Letter U with circumflex	û
252	Latin Small Letter U with diaeresis	ü
253	Latin Small Letter Y with acute	ý
254	Latin Small Letter Thorn	þ
255	Latin Small Letter Y with diaeresis	ÿ

### 6.7.11.3 Unicode

Unicode is the ultimate in character coding. It is an international standard based on ASCII and ISO 8859-1. Contrary to ASCII, UNICODE requires 16-bit characters because all characters have their own code. Currently, more than 30,000 different characters are defined. However, not all of the character images are defined in emWin. It is the responsibility of the user to define these additional characters.

## 6.7.12 Standard fonts

emWin is shipped with a selection of fonts which should cover most of your needs. The standard font package contains monospaced and proportional fonts in different sizes and styles. **Monospaced fonts** are fonts with a fixed character width, in which all characters have the same width in pixels. **Proportional fonts** are fonts in which each character has its own individual pixel-width. The following sections provide an overview of emWin standard fonts.

### 6.7.12.1 Font identifier naming convention

All standard fonts are named as follows. The components of the naming convention are explained in the table below:

```
GUI_Font[<style>][<width>x]<height>[x<MagX>x<MagY>][H][B][_<characterset>]
```

Element	Description
GUI_Font	Standard prefix for all fonts shipped with emWin.
<style>	Specifies a non-standard font style. Example: Comic style in GUI_FontComic18B_ASCII.
<width>	Width of characters, contained only in monospaced fonts.
<height>	Height of the font in pixels.
<MagX>	Factor of magnification in X, contained only in magnified fonts.
<MagY>	Factor of magnification in Y, contained only in magnified fonts.
H	Abbreviation for "high". Only used if there is more than one font with the same height. It means that the font appears "higher" than other fonts.
B	Abbreviation for "bold". Used in bold fonts.
<characterset>	Specifies the contents of characters: ASCII: Only ASCII characters 0x20-0x7E (0x7F). 1: ASCII characters and European extensions 0xA0 - 0xFF. HK: Hiragana and Katakana. 1HK: ASCII, European extensions, Hiragana and Katakana. D: Digit fonts, character set: +-.0123456789.

#### Example 1

```
GUI_Font16_ASCII
```

Element	Description
GUI_Font	Standard font prefix.
16	Height in pixels.
ASCII	Font contains ASCII characters only.

#### Example 2

```
GUI_Font8x15B_ASCII
```

Element	Description
GUI_Font	Standard font prefix.
8	Width of characters.
x15	Height in pixels.
B	Bold font.
ASCII	Font contains ASCII characters only.

### Example 3

GUI\_Font8x16x1x2

Element	Description
GUI_Font	Standard font prefix.
8	Width of characters.
x16	Height in pixels.
x1	Magnification factor in X.
x2	Magnification factor in Y.

#### 6.7.12.2 Font file naming convention

The names for the font files are similar to the names of the fonts themselves. The files are named as follows:

```
F[<width>]<height>[H][B][<characterset>]
```

Element	Description
F	Standard prefix for all fonts files shipped with emWin.
<width>	Width of characters, contained only in monospaced fonts.
<height>	Height of the font in pixels.
H	Abbreviation for "high". Only used if there is more than one font with the same height. It means that the font appears "higher" than other fonts.
B	Abbreviation for "bold". Used in bold fonts.
<characterset>	Specifies the contents of characters: ASCII: Only ASCII characters 0x20-0x7E (0x7F). 1: ASCII characters and European extensions 0xA0 - 0xFF. HK: Hiragana and Katakana. 1HK: ASCII, European extensions, Hiragana and Katakana. D: Digit fonts.

#### 6.7.12.3 Measurement, ROM-size and character set of fonts

The following sections describe the standard fonts shipped with emWin. For each font there is a measurement diagram, an overview of all characters included and a table containing the ROM size in bytes and the font files required for use.

The following parameters are used in the measurement diagrams:

Element	Description
F	Size of font in Y.
B	Distance of base line from the top of the font.
C	Height of capital characters.
L	Height of lowercase characters.
U	Size of underlength used by letters such as "g", "j" or "y".

#### 6.7.12.4 Proportional fonts

##### 6.7.12.4.1 Overview

The following screenshot gives an overview of all available proportional fonts:

GUI_Font8_ASCII	↑ABCg
GUI_Font8_1	↑ABCg
GUI_Font10S_ASCII	↑ABCg
GUI_Font10S_1	↑ABCg
GUI_Font10_ASCII	↑ABCg
GUI_Font10_1	↑ABCg
GUI_Font13_ASCII	↑ABCg
GUI_Font13_1	↑ABCg
GUI_Font13B_ASCII	↑ <b>ABCg</b>
GUI_Font13B_1	↑ <b>ABCg</b>
GUI_Font13H_ASCII	↑ABCg
GUI_Font13H_1	↑ABCg
GUI_Font13HB_ASCII	↑ <b>ABCg</b>
GUI_Font13HB_1	↑ <b>ABCg</b>
GUI_Font16_ASCII	↑ABCg
GUI_Font16_1	↑ABCg
GUI_Font16_HK	↑あぶエラ
GUI_Font16_1HK	↑ABCg
GUI_Font16B_ASCII	↑ <b>ABCg</b>
GUI_Font16B_1	↑ <b>ABCg</b>
GUI_FontConic18B_ASCII	↑ <b>ABCg</b>
GUI_FontConic18B_1	↑ <b>ABCg</b>
GUI_Font20_ASCII	↑ABCg
GUI_Font20_1	↑ABCg
GUI_Font20B_ASCII	↑ <b>ABCg</b>
GUI_Font20B_1	↑ <b>ABCg</b>
GUI_Font24_ASCII	↑ABCg
GUI_Font24_1	↑ABCg
GUI_Font24B_ASCII	↑ <b>ABCg</b>
GUI_Font24B_1	↑ <b>ABCg</b>
GUI_FontConic24B_ASCII	↑ <b>ABCg</b>
GUI_FontConic24B_1	↑ <b>ABCg</b>
GUI_Font32_ASCII	↑ABCg
GUI_Font32_1	↑ABCg
GUI_Font32B_ASCII	↑ <b>ABCg</b>
GUI_Font32B_1	↑ <b>ABCg</b>

#### 6.7.12.4.2 Font details

The following table shows the measurement, ROM size and used files of the fonts:

Font name	Measurement	ROM size in bytes	Used files
GUI_Font8_ASCII	F: 8, B: 7, C: 7, L: 5, U: 1	1562	F08_ASCII.c
GUI_Font8_1	F: 8, B: 7, C: 7, L: 5, U: 1	1562 + 1586	F08_ASCII.c F08_1.c
GUI_Font10_ASCII	F: 10, B: 9, C: 8, L: 6, U: 1	1800	F10_ASCII.c
GUI_Font10_1	F: 10, B: 9, C: 8, L: 6, U: 1	1800 + 2456	F10_ASCII.c F10_1.c
GUI_Font10S_ASCII	F: 10, B: 8, C: 6, L: 4, U: 2	1760	F10S_ASCII.c
GUI_Font10S_1	F: 10, B: 8, C: 6, L: 4, U: 2	1760 + 1770	F10S_ASCII.c F10S_1.c
GUI_Font13_ASCII	F: 13, B: 11, C: 8, L: 6, U: 2	2076	F13_ASCII.c
GUI_Font13_1	F: 13, B: 11, C: 8, L: 6, U: 2	2076 + 2149	F13_ASCII.c F13_1.c
GUI_Font13B_ASCII	F: 13, B: 11, C: 8, L: 6, U: 2	2222	F13B_ASCII.c
GUI_Font13B_1	F: 13, B: 11, C: 8, L: 6, U: 2	2222 + 2216	F13B_ASCII.c F13B_1.c
GUI_Font13H_ASCII	F: 13, B: 11, C: 9, L: 7, U: 2	2232	F13H_ASCII.c
GUI_Font13H_1	F: 13, B: 11, C: 9, L: 7, U: 2	2232 + 2291	F13H_ASCII.c F13H_1.c
GUI_Font13HB_ASCII	F: 13, B: 11, C: 9, L: 7, U: 2	2690	F13HB_ASCII.c
GUI_Font13HB_1	F: 13, B: 11, C: 9, L: 7, U: 2	2690 + 2806	F13HB_ASCII.c F13HB_1.c
GUI_Font16_ASCII	F: 16, B: 13, C: 10, L: 7, U: 3	2714	F16_ASCII.c
GUI_Font16_1	F: 16, B: 13, C: 10, L: 7, U: 3	2714 + 3850	F16_ASCII.c F16_1.c
GUI_Font16_HK	F: 16, B: 13, C: 10, L: 7, U: 3	6950	F16_HK.c
GUI_Font16_1HK	F: 16, B: 13, C: 10, L: 7, U: 3	120 + 6950 + 2714 + 3850	F16_1HK.c F16_HK.c F16_ASCII.c F16_1.c
GUI_Font16B_ASCII	F: 16, B: 13, C: 10, L: 7, U: 3	2690	F16B_ASCII.c
GUI_Font16B_1	F: 16, B: 13, C: 10, L: 7, U: 3	2690 + 2790	F16B_ASCII.c F16B_1.c
GUI_FontComic18B_ASCII	F: 18, B: 15, C: 12, L: 9, U: 3	3572	FCComic18B_ASCII.c
GUI_FontComic18B_1	F: 18, B: 15, C: 12, L: 9, U: 3	3572 + 4334	FCComic18B_ASCII.c FCComic18B_1.c
GUI_Font20_ASCII	F: 20, B: 16, C: 13, L: 10, U: 4	4044	F20_ASCII.c
GUI_Font20_1	F: 20, B: 16, C: 13, L: 10, U: 4	4044 + 4244	F20_ASCII.c F20_1.c
GUI_Font20B_ASCII	F: 20, B: 16, C: 13, L: 10, U: 4	4164	F20B_ASCII.c
GUI_Font20B_1	F: 20, B: 16, C: 13, L: 10, U: 4	4164 + 4244	F20B_ASCII.c F20B_1.c
GUI_Font24_ASCII	F: 24, B: 20, C: 17, L: 13, U: 4	4786	F24_ASCII.c
GUI_Font24_1	F: 24, B: 20, C: 17, L: 13, U: 4	4786 + 5022	F24_ASCII.c F24_1.c
GUI_Font24B_ASCII	F: 24, B: 19, C: 15, L: 11, U: 5	4858	F24B_ASCII.c
GUI_Font24B_1	F: 24, B: 19, C: 15, L: 11, U: 5	4858 + 5022	F24B_ASCII.c F24B_1.c

Font name	Measurement	ROM size in bytes	Used files
GUI_FontComic24B_ASCII	F: 24, B: 20, C: 17, L: 13, U: 4	6146	FComic24B_ASCII.c
GUI_FontComic24B_1	F: 24, B: 20, C: 17, L: 13, U: 4	6146 + 5598	FComic24B_ASCII.c FComic24B_1.c
GUI_Font32_ASCII	F: 32, B: 26, C: 20, L: 15, U: 6	7234	F32_ASCII.c
GUI_Font32_1	F: 32, B: 26, C: 20, L: 15, U: 6	7234 + 7734	F32_ASCII.c F32_1.c
GUI_Font32B_ASCII	F: 32, B: 25, C: 20, L: 15, U: 7	7842	F32B_ASCII.c
GUI_Font32B_1	F: 32, B: 25, C: 20, L: 15, U: 7	7842 + 8118	F32B_ASCII.c F32B_1.c

### 6.7.12.4.3 Characters

The following shows all characters of all proportional standard fonts:

#### GUI\_Font8\_ASCII

```
!"#$%&'()*+,-./0123456789;:<=>?@ABCDEFGHIJKLMNPOQRSTUVWXYZ[\]^_`abcdefghijklmnopqrstuvwxyz{|}~
```

#### GUI\_Font8\_1

```
!"#$%&'()*+,-./0123456789;:<=>?@ABCDEFGHIJKLMNPOQRSTUVWXYZ[\]^_`abcdefghijklmnopqrstuvwxyz{|}~ ¡¢£¥¦§¨ª«¬®¯°±²³´µ¶·¸¹º»¼½¾¿ÀÁÂÃÄÅÆÇÈÉÊËÌÍÎÏÐÑÒÓÔÕÖ×ØÙÚÛÜÝÞßàáâãäåæçèéêëìíîïðñóôõö÷øùúûüýþÿ
```

#### GUI\_Font10\_ASCII

```
!"#$%&'()*+,-./0123456789;:<=>?@ABCDEFGHIJKLMNPOQRSTUVWXYZ[\]^_`abcdefghijklmnopqrstuvwxyz{|}~
```

#### GUI\_Font10\_1

```
!"#$%&'()*+,-./0123456789;:<=>?@ABCDEFGHIJKLMNPOQRSTUVWXYZ[\]^_`abcdefghijklmnopqrstuvwxyz{|}~ ¡¢£¥¦§¨ª«¬®¯°±²³´µ¶·¸¹º»¼½¾¿ÀÁÂÃÄÅÆÇÈÉÊËÌÍÎÏÐÑÒÓÔÕÖ×ØÙÚÛÜÝÞßàáâãäåæçèéêëìíîïðñóôõö÷øùúûüýþÿ
```

#### GUI\_Font10S\_ASCII

```
!"#$%&'()*+,-./0123456789;:<=>?@ABCDEFGHIJKLMNPOQRSTUVWXYZ[\]^_`abcdefghijklmnopqrstuvwxyz{|}
```

#### GUI\_Font10S\_1

```
!"#$%&'()*+,-./0123456789;:<=>?@ABCDEFGHIJKLMNPOQRSTUVWXYZ[\]^_`abcdefghijklmnopqrstuvwxyz{|} ¡¢£¥¦§¨ª«¬®¯°±²³´µ¶·¸¹º»¼½¾¿ÀÁÂÃÄÅÆÇÈÉÊËÌÍÎÏÐÑÒÓÔÕÖ×ØÙÚÛÜÝÞßàáâãäåæçèéêëìíîïðñóôõö÷øùúûüýþÿ
```

#### GUI\_Font13\_ASCII

```
!"#$%&'()*+,-./0123456789;:<=>?@ABCDEFGHIJKLMNPOQRSTUVWXYZ[\]^_`abcdefghijklmnopqrstuvwxyz{|}~
```

#### GUI\_Font13\_1

```
!"#$%&'()*+,-./0123456789;:<=>?@ABCDEFGHIJKLMNPOQRSTUVWXYZ[\]^_`abcdefghijklmnopqrstuvwxyz{|}~ ¡¢£¥¦§¨ª«¬®¯°±²³´µ¶·¸¹º»¼½¾¿ÀÁÂÃÄÅÆÇÈÉÊËÌÍÎÏÐÑÒÓÔÕÖ×ØÙÚÛÜÝÞßàáâãäåæçèéêëìíîïðñóôõö÷øùúûüýþÿ
```



**GUI\_Font13B\_ASCII**

!"#\$%&'()\*+,-./0123456789;<=>?@ABCDEFGHIJKLMN  
OPQRSTUVWXYZ[\]^\_`abcdefghijklmnopqrstuvwxyz{|}  
~

**GUI\_Font13B\_1**

!"#\$%&'()\*+,-./0123456789;<=>?@ABCDEFGHIJKLMN  
OPQRSTUVWXYZ[\]^\_`abcdefghijklmnopqrstuvwxyz{|}  
~ ¡¢£¥¦§¨©ª«¬®¯°±²³´µ¶·¸¹º»¼½¾¿ÀÁÂÃÄÅÆÇÈÉÊË  
ÌÍÎÏÐÑÒÓÔÕÖ×ØÙÚÛÜÝÞßàáâãäåæçèéêëìíîïðñóôõö÷ø  
ùúûüýþÿ

**GUI\_Font13H\_ASCII**

!"#\$%&'()\*+,-./0123456789;<=>?@ABCDEFGHIJKLM  
NOPQRSTUVWXYZ[\]^\_`abcdefghijklmnopqrstuvwxyz{|  
}~

**GUI\_Font13H\_1**

!"#\$%&'()\*+,-./0123456789;<=>?@ABCDEFGHIJKLM  
NOPQRSTUVWXYZ[\]^\_`abcdefghijklmnopqrstuvwxyz{|  
}~ ¡¢£¥¦§¨©ª«¬®¯°±²³´µ¶·¸¹º»¼½¾¿ÀÁÂÃÄÅÆÇ  
ÈÉÊËÌÍÎÏÐÑÒÓÔÕÖ×ØÙÚÛÜÝÞßàáâãäåæçèéêëìíîïðñóôõ  
ö÷øùúûüýþÿ

**GUI\_Font13HB\_ASCII**

!"#\$%&'()\*+,-./0123456789;<=>?@ABCDEFGHI  
JKLMNOPQRSTUVWXYZ[\]^\_`abcdefghijklmnopq  
rstuvwxyz{|}~

**GUI\_Font13HB\_1**

!"#\$%&'()\*+,-./0123456789;<=>?@ABCDEFGHI  
JKLMNOPQRSTUVWXYZ[\]^\_`abcdefghijklmnopq  
rstuvwxyz{|}~ ¡¢£¥¦§¨©ª«¬®¯°±²³´µ¶·¸¹º»  
¼½¾¿ÀÁÂÃÄÅÆÇÈÉÊËÌÍÎÏÐÑÒÓÔÕÖ×ØÙÚÛÜÝÞ  
ßàáâãäåæçèéêëìíîïðñóôõö÷øùúûüýþÿ

**GUI\_Font16\_ASCII**

!"#\$%&'()\*+,-./0123456789;<=>?@ABCDEFGHIJKLM  
NOPQRSTUVWXYZ[\]^\_`abcdefghijklmnopqrstuvwxyz{|}  
~

**GUI\_Font16\_1**

!"#\$%&'()\*+,-./0123456789;<=>?@ABCDEFGHIJKLM  
NOPQRSTUVWXYZ[\]^\_`abcdefghijklmnopqrstuvwxyz{|}  
~ ¡¢£¥¦§¨©ª«¬®¯°±²³´µ¶·¸¹º»¼½¾¿ÀÁÂÃÄÅÆÇÈÉÊË  
ÌÍÎÏÐÑÒÓÔÕÖ×ØÙÚÛÜÝÞßàáâãäåæçèéêëìíîïðñóôõö  
÷øùúûüýþÿ

GUI\_Font16\_HK

```

ああいううええおおかがきぎくぐげげごご
さざしじすずせぜそぞただちぢっつづてでと
どなにぬねのはばばひびびふぶぶへべべほぼ
ぼまみむめもややゆゆよよらりるれろわわゐ
ゑをんァアイイウウエエオオカガキギクグケ
ゲゴゴサザシジスズセゼソゾタダチヂッツツ
テテトトナニヌネノハババヒビビフブブヘベ
ベホボボマミムメモヤヤユユヨヨラリルレロ
ワヰヱヰンヴカケ

```

GUI\_Font16\_1HK

```

!"#$%&'()*+,-./0123456789:;<=>?@ABCDEFGHIJKLM
NOPQRSTUVWXYZ[\]^_`abcdefghijklmnopqrstuvwxyz{|}
~ ¡¢£¥¦§¨ª«¬®¯°±²³´µ¶·¸¹º»¼½¾¿ÀÁÂÃÄÅÆÇÈÉÊË
ËÌÍÎÏÐÑÒÓÔÕÖ×ØÙÚÛÜÝÞßàáâãääåæçèéêëìíîïðñòóôõö
÷øùúûüýþÿ ああいううええおおかがきぎくぐ
げげごごさざしじすずせぜそぞただちぢっつ
づてでとどなにぬねのはばばひびびふぶぶへ
べべほぼぼまみむめもややゆゆよよらりるれ
ろわわゐゑをんァアイイウウエエオオカガキ
ギクグケゲゴゴサザシジスズセゼソゾタダチ
ヂッツツテテトトナニヌネノハババヒビビフ
ブブヘベベホボボマミムメモヤヤユユヨヨラ
リルレロワヰヱヰンヴカケ

```

GUI\_Font16B\_ASCII

```

!"#$%&'()*+,-./0123456789:;<=>?@ABCDEFGHIJKLM
NOPQRSTUVWXYZ[\]^_`abcdefghijklmnopqrstuvwxyz
xyz{~`

```

GUI\_Font16B\_1

```

!"#$%&'()*+,-./0123456789:;<=>?@ABCDEFGHIJKLM
NOPQRSTUVWXYZ[\]^_`abcdefghijklmnopqrstuvwxyz
xyz{~ ¡¢£¥¦§¨ª«¬®¯°±²³´µ¶·¸¹º»¼½¾¿ÀÁÂÃÄÅÆ
ÇÈÉÊËÌÍÎÏÐÑÒÓÔÕÖ×ØÙÚÛÜÝÞßàáâãääåæçèéêëìíîï
ðñòóôõö÷øùúûüýþÿ

```

GUI\_FontComic18B\_ASCII

```

!"#$%&'()*+,-./0123456789:;<=>?@ABCD
EFGHIJKLMNOPQRSTUVWXYZ[\]^_`ab
cdefghijklmnopqrstuvwxyz{|}~€

```

GUI\_FontComic18B\_1

```

!"#$%&'()*+,-./0123456789:;<=>?@ABCD
EFGHIJKLMNOPQRSTUVWXYZ[\]^_`ab
cdefghijklmnopqrstuvwxyz{|}~ ¡¢£¥¦§¨ª«¬®¯°±²³´µ¶·¸¹º»¼½¾¿ÀÁÂÃÄÅÆÇ
ÈÉÊËÌÍÎÏÐÑÒÓÔÕÖ×ØÙÚÛÜÝÞßàáâãääåæçèéêëìíîïðñòóôõö÷øùúûüýþÿ

```

GUI\_Font20\_ASCII

!"#\$%&'()\*+,-./0123456789:;<=>?@AB  
CDEFGHIJKLMNOPQRSTUVWXYZ[\]^  
\_`abcdefghijklmnopqrstuvwxyz{|}~

GUI\_Font20\_1

!"#\$%&'()\*+,-./0123456789:;<=>?@AB  
CDEFGHIJKLMNOPQRSTUVWXYZ[\]^  
\_`abcdefghijklmnopqrstuvwxyz{|}~ ¡¢£  
¥¦§¨ª«¬®¯°±²³´µ¶·¸¹º»¼½¾¿ÀÁÂÃÄÅ  
ÆÇÈÉÊËÌÍÎÏÐÑÒÓÔÕÖ×ØÙÚÛÜÝÞßà  
áâãääåæçèéêëìíîïðñòóôõ÷øùúûüýþÿ

GUI\_Font20B\_ASCII

!"#\$%&'()\*+,-./0123456789:;<=>?@A  
BCDEFGHIJKLMNOPQRSTUVWXYZ[  
\]^\_`abcdefghijklmnopqrstuvwxyz{|}  
~

GUI\_Font20B\_1

!"#\$%&'()\*+,-./0123456789:;<=>?@A  
BCDEFGHIJKLMNOPQRSTUVWXYZ[  
\]^\_`abcdefghijklmnopqrstuvwxyz{|}  
~ ¡¢£  
¥¦§¨ª«¬®¯°±²³´µ¶·¸¹º»¼½¾¿À  
ÁÂÃÄÅÆÇÈÉÊËÌÍÎÏÐÑÒÓÔÕÖ×ØÙ  
ÚÛÜÝÞßàáâãääåæçèéêëìíîïðñòóôõ÷øù  
úûüýþÿ

GUI\_Font24\_ASCII

!"#\$%&'()\*+,-./0123456789:;<=>?  
@ABCDEFGHIJKLMNOPQRSTU  
VWXYZ[\]^\_`abcdefghijklmnopqrst  
uvwxyz{|}~

GUI\_Font24\_1

!"#\$%&'()\*+,-./0123456789:;<=>?  
@ABCDEFGHIJKLMNOPQRSTU  
VWXYZ[\]^\_`abcdefghijklmnopqrst  
uvwxyz{|}~ ¡¢£  
¥¦§¨ª«¬®¯°±²³´µ¶·¸¹º»¼½¾¿À  
ÁÂÃÄÅÆÇÈÉÊËÌÍÎÏÐÑÒÓÔÕÖ×ØÙ  
ÚÛÜÝÞßàáâãääåæçèéêëìíîïðñòóôõ÷øù  
úûüýþÿ

GUI\_Font24B\_ASCII

!"#\$%&'()\*+,-./0123456789:;<=>  
?@ABCDEFGHIJKLMNQRST  
UVWXYZ[\]^\_`abcdefghijklmnop  
qrstuvwxyz{|}~

GUI\_Font24B\_1

!"#\$%&'()\*+,-./0123456789:;<=>  
?@ABCDEFGHIJKLMNQRST  
UVWXYZ[\]^\_`abcdefghijklmnop  
qrstuvwxyz{|}~ ¡¢£¥¦§¨ª«¬®¯  
°±²³´µ¶·¸¹º»¼½¾¿ÀÁÂÃÄÅÆÇÈ  
ÉÊËÌÍÎÏÐÑÒÓÔÕÖ×ØÙÚÛÜÝÞßàá  
âãääåæçèéêëìíîïðñòóôõö÷øùúûü  
ýþÿ

GUI\_FontComic24B\_ASCII

!"#\$%&'()\*+,-./0123456789:  
;<=>?@ABCDEFGHIJKLMN  
OPQRSTUVWXYZ[\]^\_`  
abcdefghijklmnopqrstu  
vwxyz{|}~□

GUI\_FontComic24B\_1

!"#\$%&'()\*+,-./0123456789:  
;<=>?@ABCDEFGHIJKLMN  
OPQRSTUVWXYZ[\]^\_`  
abcdefghijklmnopqrstu  
vwxyz{|}~□ ¡¢£¥¦  
§¨ª«¬®¯°±²³´µ¶·¸¹º»¼½¾  
¿ÀÁÂÃÄÅÆÇÈÉÊËÌÍÎÏÐÑÒÓ  
ÔÕÖ×ØÙÚÛÜÝÞßàáâãääåæçèéêë  
ìíîïðñòóôõö÷øùúûüýþÿ

GUI\_Font32\_ASCII

!"#\$%&'()\*+,-./012345678  
9:;<=>?@ABCDEFGHIJK  
LMNOPQRSTUVWXYZ[\]  
^\_`abcdefghijklmnopqrstu  
vwxyz{|}~

GUI\_Font32\_1

!"#\$%&'()\*+,-./012345678  
 9:;<=>?@ABCDEFGHIJK  
 LMNOPQRSTUVWXYZ[\  
 ^\_`abcdefghijklmnopqrstu  
 vxyz{|}~ ¡¢£¤¥¦§¨©ª«¬®¯°  
 ±²³´µ¶·¸¹º»¼½¾¿ÀÁÂÃÄÅ  
 ÆÇÈÉÊËÌÍÎÏÐÑÒÓÔÕÖ×  
 ØÙÚÛÜÝÞßàáâãääåæçèé  
 êëìíîïðñòóôõö÷øùúûüýþÿ

GUI\_Font32B\_ASCII

**!"#\$%&'()\*+,-./01234567  
 89:;<=>?@ABCDEFGHIJK  
 KLMNOPQRSTUVWXYZ[  
 \]^\_`abcdefghijklmnopq  
 rstuvwxyz{|}~**

GUI\_Font32B\_1

**!"#\$%&'()\*+,-./01234567  
 89:;<=>?@ABCDEFGHIJK  
 KLMNOPQRSTUVWXYZ[  
 \]^\_`abcdefghijklmnopq  
 rstuvwxyz{|}~ ¡¢£¤¥¦§¨©ª«¬®¯°  
 ±²³´µ¶·¸¹º»¼½¾¿À  
 ÁÂÃÄÅÆÇÈÉÊËÌÍÎÏÐ  
 ÑÒÓÔÕÖ×ØÙÚÛÜÝÞßà  
 áâãääåæçèéêëìíîïðñ  
 òóôõö÷øùúûüýþÿ**

### 6.7.12.5 Proportional fonts, framed

#### 6.7.12.5.1 Overview

The following screenshot shows the currently available framed proportional fonts:



#### 6.7.12.5.2 Font details

The following table shows the measurement, ROM size and used file of the font:

Font name	Measurement	ROM size in bytes	Used files
GUI_Font20F_ASCII	F: 20, B: 19, C: 19, L: 19, U: 1	5248	F20F_ASCII.c

#### 6.7.12.5.3 Characters

The following shows all characters of the font:

##### GUI\_Font20F\_ASCII

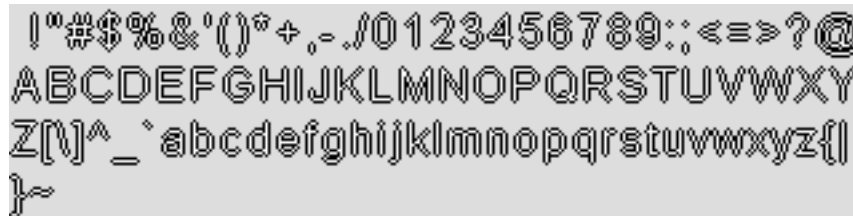

### 6.7.12.6 Monospaced fonts

#### 6.7.12.6.1 Overview

The following screenshot gives an overview of all available monospaced fonts:



### 6.7.12.6.2 Font details

The following table shows the measurement, ROM size and used files of the fonts:

Font name	Measurement	ROM size in bytes	Used files
GUI_Font4x6	F: 6, B: 5, C: 5, L: 4, U: 1	620	F4x6.c
GUI_Font6x8	F: 8, B: 7, C: 7, L: 5, U: 1	1840	F6x8.c
GUI_Font6x8_ASCII	F: 8, B: 7, C: 7, L: 5, U: 1	1568	F6x8_ASCII.c
GUI_Font6x8_1	F: 8, B: 7, C: 7, L: 5, U: 1	1568 + 1584	F6x8_ASCII.c F6x8_1.c
GUI_Font6x9	F: 9, B: 7, C: 7, L: 5, U: 2	1840 (same ROM location as GUI_Font8x16)	F6x8.c
GUI_Font8x8	F: 8, B: 7, C: 7, L: 5, U: 1	1840	F8x8.c
GUI_Font8x8_ASCII	F: 8, B: 7, C: 7, L: 5, U: 1	1568	F8x8_ASCII.c
GUI_Font8x8_1	F: 8, B: 7, C: 7, L: 5, U: 1	1568 + 1584	F8x8_ASCII.c F8x8_1.c
GUI_Font8x9	F: 9, B: 7, C: 7, L: 5, U: 2	1840 (same ROM location as GUI_Font8x16)	F8x8.c
GUI_Font8x10_ASCII	F: 10, B: 9, C: 9, L: 7, U: 1	1770	F8x10_ASCII.c
GUI_Font8x12_ASCII	F: 12, B: 10, C: 9, L: 6, U: 2	1962	F8x12_ASCII.c
GUI_Font8x13_ASCII	F: 13, B: 11, C: 9, L: 6, U: 2	2058	F8x13_ASCII.c
GUI_Font8x13_1	F: 13, B: 11, C: 9, L: 6, U: 2	2058 + 2070	F8x13_ASCII.c F8x13_1.c
GUI_Font8x15B_ASCII	F: 15, B: 12, C: 9, L: 7, U: 3	2250	F8x15_ASCII.c
GUI_Font8x15B_1	F: 15, B: 12, C: 9, L: 7, U: 3	2250 + 2262	F8x15B_ASCII.c F8x15B_1.c
GUI_Font8x16	F: 16, B: 12, C: 10, L: 7, U: 4	3304	F8x16.c
GUI_Font8x17	F: 17, B: 12, C: 10, L: 7, U: 5	3304 (same ROM location as GUI_Font8x16)	F8x16.c
GUI_Font8x18	F: 18, B: 12, C: 10, L: 7, U: 6	3304 (same ROM location as GUI_Font8x16)	F8x16.c
GUI_Font8x16x1x2	F: 32, B: 24, C: 20, L: 14, U: 8	3304 (same ROM location as GUI_Font8x16)	F8x16.c
GUI_Font8x16x2x2	F: 32, B: 24, C: 20, L: 14, U: 8	3304 (same ROM location as GUI_Font8x16)	F8x16.c
GUI_Font8x16x3x3	F: 48, B: 36, C: 30, L: 21, U: 12	3304 (same ROM location as GUI_Font8x16)	F8x16.c
GUI_Font8x16_ASCII	F: 16, B: 12, C: 10, L: 7, U: 4	3572 + 4334	F8x16_ASCII.c
GUI_Font8x16_1	F: 16, B: 12, C: 10, L: 7, U: 4	4044	F8x16_ASCII.c F8x16_1.c

### 6.7.12.6.3 Characters

The following shows all characters of all monospaced standard fonts:

GUI\_Font4x6

!'"#%&'()\*+,-./0123456789:;<=>?@ABCDEFGHIJKLMNopqrstuvwxYZ[\]^\_`abcdefghijklmnopqrstuvwxyz{|}~`

GUI\_Font6x8

!'"#%&'()\*+,-./0123456789:;<=>?@ABCDEFGHIJKLMNopqrstuvwxYZ[\]^\_`abcdefghijklmnopqrstuvwxyz{|}~`

GUI\_Font6x8\_ASCII

!'"#%&'()\*+,-./0123456789:;<=>?@ABCDEFGHIJKLMNopqrstuvwxYZ[\]^\_`abcdefghijklmnopqrstuvwxyz{|}~`

GUI\_Font6x8\_1

!'"#%&'()\*+,-./0123456789:;<=>?@ABCDEFGHIJKLMNopqrstuvwxYZ[\]^\_`abcdefghijklmnopqrstuvwxyz{|}~`

GUI\_Font6x9

!'"#%&'()\*+,-./0123456789:;<=>?@ABCDEFGHIJKLMNopqrstuvwxYZ[\]^\_`abcdefghijklmnopqrstuvwxyz{|}~`

GUI\_Font8x8

!'"#\$%&'()\*+,-./0123456789:;<=>?@ABCDEFGHIJKLMNopqrstuvwxYZ[\]^\_`abcdefghijklmnopqrstuvwxyz{|}~`

GUI\_Font8x8\_ASCII

!'"#\$%&'()\*+,-./0123456789:;<=>?@ABCDEFGHIJKLMNopqrstuvwxYZ[\]^\_`abcdefghijklmnopqrstuvwxyz{|}~`

GUI\_Font8x8\_1

!'"#\$%&'()\*+,-./0123456789:;<=>?@ABCDEFGHIJKLMNopqrstuvwxYZ[\]^\_`abcdefghijklmnopqrstuvwxyz{|}~`

GUI\_Font8x9

!'"#\$%&'()\*+,-./0123456789:;<=>?@ABCDEFGHIJKLMNopqrstuvwxYZ[\]^\_`abcdefghijklmnopqrstuvwxyz{|}~`

GUI\_Font8x10\_ASCII

!'"#\$%&'()\*+,-./0123456789:;<=>?@ABCDEFGHIJKLMNopqrstuvwxYZ[\]^\_`abcdefghijklmnopqrstuvwxyz{|}~`

GUI\_Font8x12\_ASCII

!'"#\$%&'()\*+,-./0123456789:;<=>?@ABCDEFGHIJKLMNopqrstuvwxYZ[\]^\_`abcdefghijklmnopqrstuvwxyz{|}~`



**GUI\_Font8x13\_ASCII**

!"#\$%&'()\*+,-./0123456789:;<=>?@ABCDEFGH  
IJKLMNOPQRSTUVWXYZ[\]^\_`abcdefghijklmnop  
qrstuvwxyz{|}~■

**GUI\_Font8x13\_1**

!"#\$%&'()\*+,-./0123456789:;<=>?@ABCDEFGH  
IJKLMNOPQRSTUVWXYZ[\]^\_`abcdefghijklmnop  
qrstuvwxyz{|}~■ ¡¢£¥¦§¨ª«¬®¯°±²³´µ¶·  
¸¹º»¼½¾¿ÀÁÂÃÄÅÆÇÈÉÊËÌÍÎÏÐÑÒÓÔÕÖ×ØÙÚÛÜÝÞß  
àáâãäåæçèéêëìíîïðñòóôõö÷øùúûüýþÿ

**GUI\_Font8x15B\_ASCII**

!"#\$%&'()\*+,-./0123456789:;<=>?@ABCDEFGH  
IJKLMNOPQRSTUVWXYZ[\]^\_`abcdefghijklmnop  
qrstuvwxyz{|}~■

**GUI\_Font8x15B\_1**

!"#\$%&'()\*+,-./0123456789:;<=>?@ABCDEFGH  
IJKLMNOPQRSTUVWXYZ[\]^\_`abcdefghijklmnop  
qrstuvwxyz{|}~■ ¡¢£¥¦§¨ª«¬®¯°±²³´µ¶·  
¸¹º»¼½¾¿ÀÁÂÃÄÅÆÇÈÉÊËÌÍÎÏÐÑÒÓÔÕÖ×ØÙÚÛÜÝÞß  
àáâãäåæçèéêëìíîïðñòóôõö÷øùúûüýþÿ

**GUI\_Font8x16**

!"#\$%&'()\*+,-./0123456789:;<=>?@ABCDEFGH  
IJKLMNOPQRSTUVWXYZ[\]^\_`abcdefghijklmnop  
qrstuvwxyz{|}~^ ↔↑↓↙ ↘ ¡¢£¥¦§¨ª«¬®¯°±  
²³´µ¶·¸¹º»¼½¾¿ÀÁÂÃÄÅÆÇÈÉÊËÌÍÎÏÐÑÒÓÔÕÖ×ØÙ  
ÚÛÜÝÞßàáâãäåæçèéêëìíîïðñòóôõö÷øùúûüýþÿ

**GUI\_Font8x17**

!"#\$%&'()\*+,-./0123456789:;<=>?@ABCDEFGH  
IJKLMNOPQRSTUVWXYZ[\]^\_`abcdefghijklmnop  
qrstuvwxyz{|}~^ ↔↑↓↙ ↘ ¡¢£¥¦§¨ª«¬®¯°±  
²³´µ¶·¸¹º»¼½¾¿ÀÁÂÃÄÅÆÇÈÉÊËÌÍÎÏÐÑÒÓÔÕÖ×ØÙ  
ÚÛÜÝÞßàáâãäåæçèéêëìíîïðñòóôõö÷øùúûüýþÿ

**GUI\_Font8x18**

!"#\$%&'()\*+,-./0123456789:;<=>?@ABCDEFGH  
IJKLMNOPQRSTUVWXYZ[\]^\_`abcdefghijklmnop  
qrstuvwxyz{|}~^ ↔↑↓↙ ↘ ¡¢£¥¦§¨ª«¬®¯°±  
²³´µ¶·¸¹º»¼½¾¿ÀÁÂÃÄÅÆÇÈÉÊËÌÍÎÏÐÑÒÓÔÕÖ×ØÙ  
ÚÛÜÝÞßàáâãäåæçèéêëìíîïðñòóôõö÷øùúûüýþÿ

GUI\_Font8x16x1x2

!"#\$%&'()\*+,-./0123456789:;<=>?@ABCDEFGH  
 IJKLMNOPQRSTUVWXYZ[\]^\_`abcdefghijklmnop  
 qrstuvwxyz{|}~`↔↑↓↕ ¡¢£¥¦§¨ª«¬®¯°±  
 ²³´µ¶·¸¹º»¼½¾¿ÀÁÂÃÄÅÆÇÈÉÊËÌÍÎÏÐÑÒÓÔÕÖ×ØÙ  
 ÚÛÜÝÞßàáâãäåæçèéêëìíîïðñòóôõö÷øùúûüýþÿ

GUI\_Font8x16x2x2

!"#\$%&'()\*+,-./0123  
 456789:;<=>?@ABCDEFGH  
 IJKLMNOPQRSTUVWXYZ[\]^\_`abcdefghijklmnop  
 qrstuvwxyz{|}~`↔↑↓↕ ¡¢£¥¦§¨ª«¬®¯°±  
 ²³´µ¶·¸¹º»¼½¾¿ÀÁÂÃÄÅÆÇÈÉÊËÌÍÎÏÐÑÒÓÔÕÖ×ØÙ  
 ÚÛÜÝÞßàáâãäåæçèéêëìíîïðñòóôõö÷øùúûüýþÿ

GUI\_Font8x16x3x3

!"#\$%&'()\*+,-./0123456789  
 :;<=>?@ABCDEFGHIJKL  
 MNOPQRSTUVWXYZ[\]^\_`  
 abcdefghijklmnopqrstu  
 vwxyz{|}~`↔↑↓↵ ¡  
 ¢£¤¥¦§¨ª«¬®¯°±²³´µ¶·¸¹º»¼½¾¿ÀÁÂÃÄÅÆÇÈÉ  
 ÊËÌÍÎÏÐÑÒÓÔÕÖ×ØÙÚÛÜÝÞßàáâãäåæçèéêëìíîï  
 ðñòóôõö÷øùúûüýþÿ

GUI\_Font8x16\_ASCII

!"#\$%&'()\*+,-./0123456789  
 :;<=>?@ABCDEFGHIJKL  
 MNOPQRSTUVWXYZ[\]^\_`  
 abcdefghijklmnopqrstu  
 vwxyz{|}~`

GUI\_Font8x16\_1

!"#\$%&'()\*+,-./0123456789  
 :;<=>?@ABCDEFGHIJKL  
 MNOPQRSTUVWXYZ[\]^\_`  
 abcdefghijklmnopqrstu  
 vwxyz{|}~` ¡¢£¥¦§¨ª«¬®¯°±²³´µ¶·¸¹º»¼½¾¿ÀÁÂÃÄÅÆÇÈÉ  
 ÊËÌÍÎÏÐÑÒÓÔÕÖ×ØÙÚÛÜÝÞßàáâãäåæçèéêëìíîï  
 ðñòóôõö÷øùúûüýþÿ

6.7.12.7 Digit fonts (proportional)

6.7.12.7.1 Overview

The following screenshot gives an overview of all available proportional digit fonts:

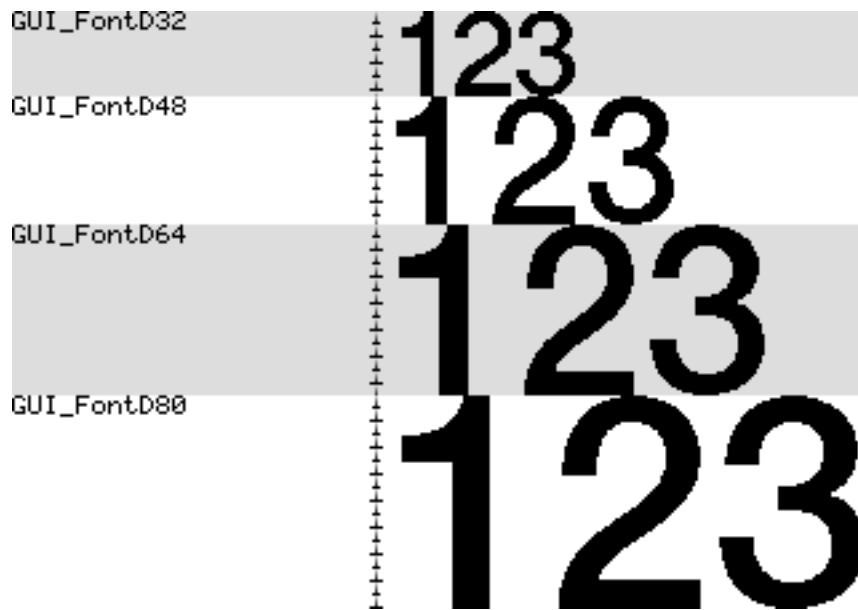

### 6.7.12.7.2 Font details

The following table shows the measurement, ROM size and used files of the fonts:

Font name	Measurement	ROM size in bytes	Used files
GUI_FontD32	F: 32, C: 31	1574	FD32.c
GUI_FontD48	F: 48, C: 47	3512	FD48.c
GUI_FontD64	F: 64, C: 63	5384	FD64.c
GUI_FontD80	F: 80, C: 79	8840	FD80.c

### 6.7.12.7.3 Characters

The following shows all characters of all proportional digit fonts:

#### GUI\_FontD32

+,-.012345678  
9:

#### GUI\_FontD48

+,-.01234  
56789:

GUI\_FontD64

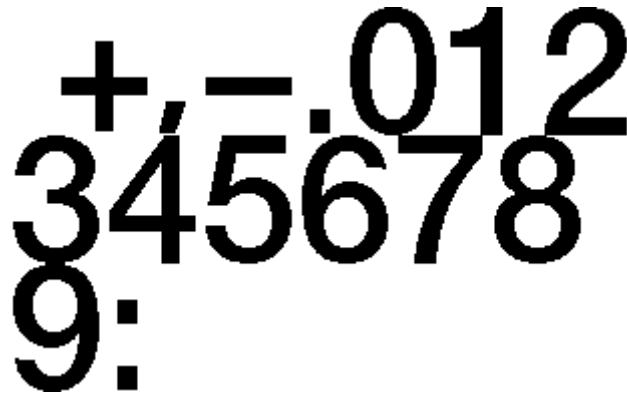

GUI\_FontD80

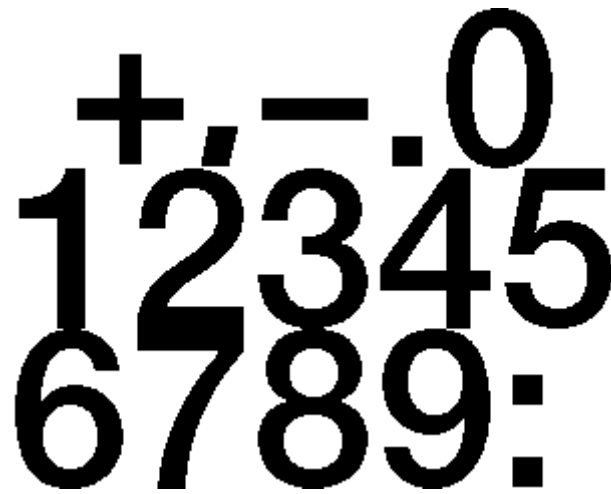

6.7.12.8 Digit fonts (monospaced)

6.7.12.8.1 Overview

The following screenshot gives an overview of all available monospaced digit fonts:

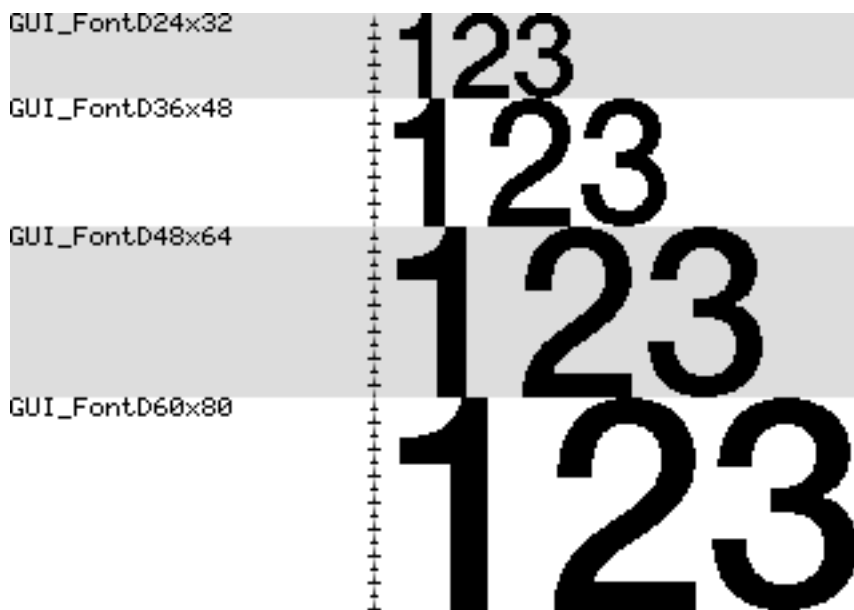

6.7.12.8.2 Font details

The following table shows the measurement, ROM size and used files of the fonts:

Font name	Measurement	ROM size in bytes	Used files
GUI_FontD24x32	F: 32, C: 31	1606	FD24x32.c
GUI_FontD36x48	F: 48, C: 47	3800	FD36x48.c
GUI_FontD48x64	F: 64, C: 63	5960	FD48x64.c
GUI_FontD60x80	F: 80, C: 79	9800	FD60x80.c

### 6.7.12.8.3 Characters

The following shows all characters of all monospaced digit fonts:

#### GUI\_FontD24x32

+ , - . 0 1 2 3 4 5 6 7  
8 9 :

#### GUI\_FontD36x48

+ , - . 0 1 2  
3 4 5 6 7 8 9 :

#### GUI\_FontD48x64

+ , - . 0  
1 2 3 4 5 6  
7 8 9 :

**GUI\_FontD60x80**

0 1 2 3 4  
5 6 7 8 9  
:

## 6.8 Animations

Animations can be achieved by playing GIF animations, movies or showing animated graphic objects. Whereas GIF animations and movies can be used only for playing a fixed sequence of pictures, the animation object of emWin is able to draw runtime generated scenes of one or multiple independent animated objects, which could be used to reflect dynamic application data. The following chapter explains how the animation object could be used to achieve user defined animations.

### 6.8.1 Introduction

Bringing up motion into an application could be done by several ways. If a fixed sequence of pictures does not work and one or more objects should change their properties like position, color, shape, size or whatever within a given period of time, emWin offers an animation object for exactly that purpose. It is able to animate multiple animation items during the timeline of an animation. Animation item means a custom defined routine which receives a position value from the animation object. That value is calculated in dependence of the current point in time. The calculation could be done by predefined or custom defined methods.

Each item has its own start and end time which determine if it is called or not during the execution.



## 6.8.2 Creating an animation object

Creating an animation object is done by passing the duration and the minimum time per 'slice' to the creation routine. Optionally a custom defined void pointer and a pointer to a 'slice callback' routine could be passed. The term 'slice' will be explained later. After the handle of an animation object is available one or more animation items could be added to the animation.

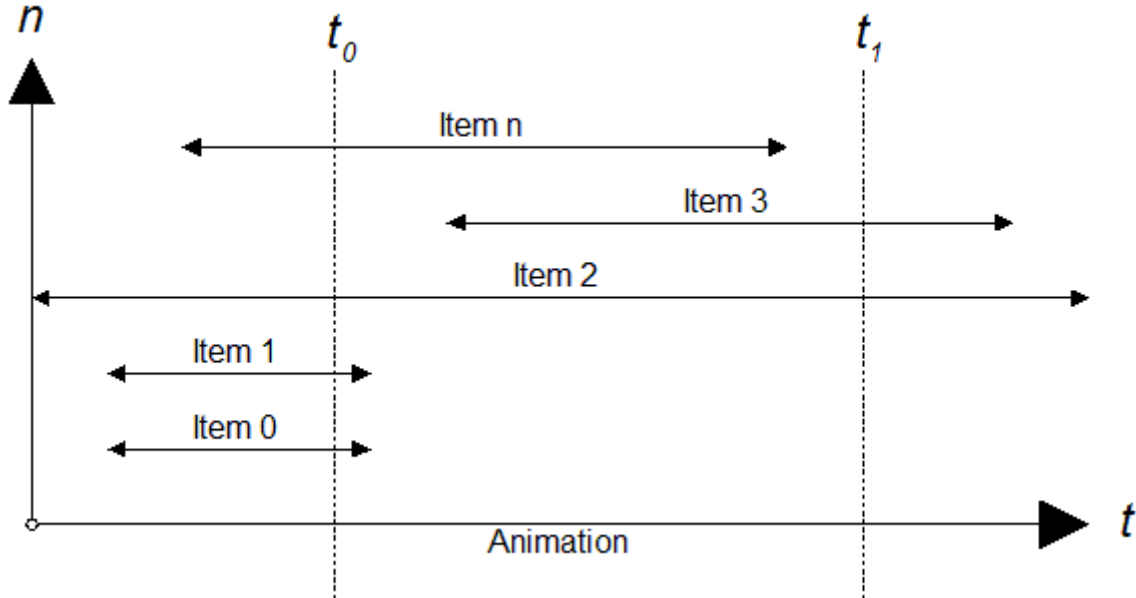

The diagram shows an animation with several items within the animation period where each item has its own start and end time. emWin does not limit the number of items. Start time and end time of each item have to be within the timeline of the animation.

### Example

```
//
// Creating an animation of 4 seconds and a min time/slice of 50ms
//
hAnim = GUI_ANIM_Create(4000, 50, NULL, NULL);
```

## 6.8.3 Adding items to an animation

An animation item is a routine which receives information from the animation object during the period of execution. When adding an item its start time, end time, 'method of position calculation' and animation routine to be called should be passed. Further an optional void pointer could be used which is passed to the animation routine during the animation is executed.

### Example

```
static void _AnimDrawSomething(GUI_ANIM_INFO * pInfo, void * pVoid) {
    ...
}
void Application(void){
    ...
    GUI_ANIM_AddItem(hAnim, 500, 2500, ANIM_LINEAR, pVoid, _AnimDrawSomething);
    ...
}
```

## 6.8.4 Position calculation

Each item has its own start and end time within the timeline of the animation. If the current point of time is within the period of an item, the animation object calculates a position value. The following table shows the available methods for calculating the position value:

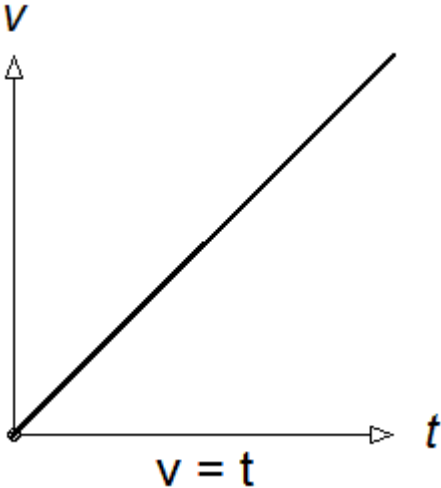
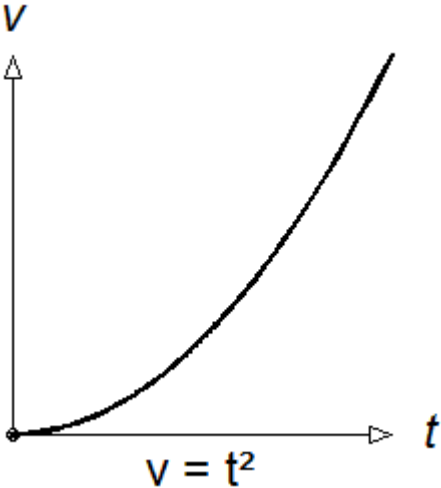
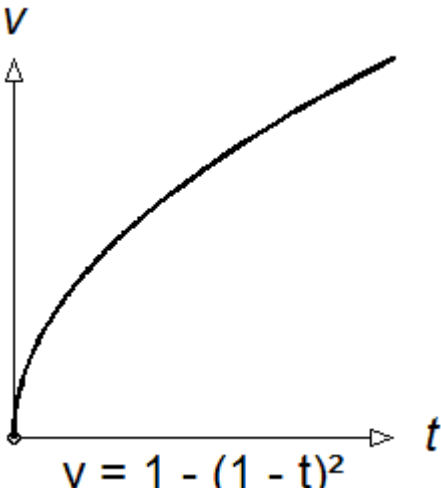
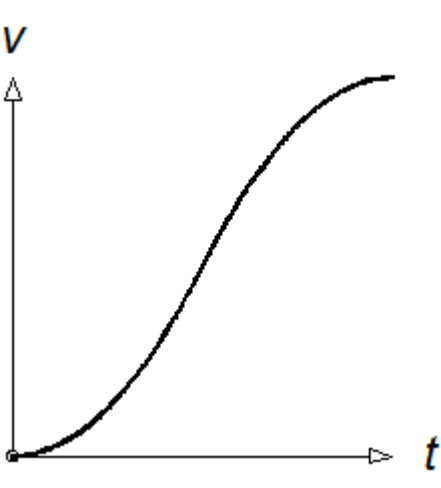
ANIM_LINEAR	ANIM_ACCEL
 <p data-bbox="427 882 528 920"><math>v = t</math></p>	 <p data-bbox="1021 882 1121 920"><math>v = t^2</math></p>
ANIM_DECEL	ANIM_ACCELDECEL
 <p data-bbox="331 1525 624 1565"><math>v = 1 - (1 - t)^2</math></p>	

The value passed to the application is between 0 and GUI\_ANIM\_RANGE. If for example ANIM\_ACCEL is used and the animation item is currently exactly in the middle the value passed to the application is  $0.5 * 0.5 * \text{GUI\_ANIM\_RANGE}$ .

### GUI\_ANIM\_RANGE

That value is defined by emWin as follows:

Type	Macro	Default	Description
v	GUI_ANIM_RANGE	32767	Define the default range of an animation.

The value could be changed on demand.

### 6.8.4.1 Custom defined position calculation

If the above predefined methods do not meet the requirements a custom defined routine could be used. The below sample shows how that works. The routine is called by the animation object each time a single position value is required. The routine gets start time, end time and current time of the animation item. Its job is to calculate a value in dependence of the given parameters. The predefined methods of emWin generate values between 0 and GUI\_ANIM\_RANGE. If a custom defined routine is used the range could be different.

#### Example

```
I32 _CalcPosition(GUI_TIMER_TIME ts, GUI_TIMER_TIME te, GUI_TIMER_TIME tNow) {  
    ...  
}  
void Application(void) {  
    ...  
    GUI_ANIM_AddItem(hAnim, ..., ..., _CalcPosition, ..., ...);  
    ...  
}
```

## 6.8.5 Executing an animation

Simply call `GUI_ANIM_StartEx()`. That function offers the possibility to run an animation a determined number of times or within an endless loop. `GUI_ANIM_Stop()` could be used to stop an animation which is running. Alternatively `GUI_ANIM_Exec()` could be called periodically to keep an animation alive, but most recommended is using automatic mode.

Each time emWin executes an animation (auto mode or with `GUI_ANIM_Exec()`) it checks which items of the given animation are within the current point of time. That collection of items represents one slice of animation items which are called at the given point of time. The animation diagram at the beginning for example shows the points of time  $t_0$  and  $t_1$ . The  $t_0$  slice consists of items 0, 1, 2 and n and the  $t_1$  slice of item 2 and 3. The following example shows how an animation could be executed:

### Example

```
void Application(void) {
    ...
    GUI_ANIM_StartEx(hAnim, -1, NULL); // Start animation in endless loop
    ...
    while (1) {
        GUI_Delay(1);
    }
}
```

### 6.8.5.1 Using a slice callback function

Before calling the first item of an animation slice and after calling the last item an optional callback function could be called. A slice callback function could be used for example to avoid flickering. Before drawing the first item the application could switch to the back buffer or lock the cache and after drawing the last item the back buffer could be made visible or the cache could be unlocked. To use a slice callback function a pointer to that function should be passed to the creation routine.

### Example

```
static void _cbSliceInfo(int State, void * pVoid) {
    switch (State) {
        case GUI_ANIM_START:
            GUI_MULTIBUF_Begin();
            break;
        case GUI_ANIM_END:
            GUI_MULTIBUF_End();
            break;
    }
}

void Application(void) {
    ...
    hAnim = GUI_ANIM_Create(..., ..., pVoid, _cbSliceInfo);
}
```

### 6.8.5.2 Animation item

An animation item is simply a routine which is executed by the animation object. It is called by passing a pointer to a `GUI_ANIM_INFO` structure and the application defined void pointer passed to `GUI_ANIM_AddItem()`.

### Prototype

```
static void _AnimDrawRect(GUI_ANIM_INFO * pInfo,
                        void * pVoid);
```

### 6.8.5.3 Using a delete callback function

A delete callback is a routine that will be called when an animation has ended. This can be useful e.g. when a window handle should be deleted after an animation has finished. A delete callback is also called, when `GUI_ANIM_Delete()` is called for an animation.

#### Prototype

```
static void _OnDelete(void * pVoid);
```

#### Usage

A delete callback can be set for an animation by passing the function pointer to `GUI_ANIM_StartEx()`. The void pointer passed to `GUI_ANIM_Create()` as third parameter will also be passed to the delete callback of that animation.

#### Example

```
static void _OnDelete(void * pVoid) {
    ANIM_DATA * pData;
    pData = (ANIM_DATA *)pVoid;
    ...
}
...
ANIM_DATA Data;
...
hAnim = GUI_ANIM_Create(ANIM_PERIOD, 50, &Data, NULL);
...
GUI_ANIM_StartEx(hAnim, 1, _OnDelete);
```

## 6.8.6 Animations API

The following table lists the animation related API functions.

### Functions

Routine	Description
<code>GUI_ANIM_AddItem()</code>	Adds an item to the given animation.
<code>GUI_ANIM_AddItemById()</code>	Adds an item to the given animation.
<code>GUI_ANIM_Create()</code>	Creates an animation object.
<code>GUI_ANIM_CreateWithId()</code>	Creates an animation object.
<code>GUI_ANIM_Delete()</code>	Deletes an animation object and all of its data.
<code>GUI_ANIM_DeleteAll()</code>	Deletes all animations.
<code>GUI_ANIM_DeleteById()</code>	Deletes an animation object and all of its data.
<code>GUI_ANIM_Exec()</code>	Should be used to keep the given animation alive.
<code>GUI_ANIM_Get()</code>	Returns the handle of the given animation.
<code>GUI_ANIM_GetData()</code>	Returns the optional void pointer passed to the animation with <code>GUI_ANIM_Create()</code> .
<code>GUI_ANIM_GetFirst()</code>	Returns the handle of the first animation to be executed automatically.
<code>GUI_ANIM_GetItemData()</code>	Returns the optional void pointer passed to an animation item with <code>GUI_ANIM_AddItem()</code> .
<code>GUI_ANIM_GetNext()</code>	Returns the handle of the next animation to be executed after the given animation.
<code>GUI_ANIM_GetNumItems()</code>	Returns the number of items in an animation.
<code>GUI_ANIM_GetPeriod()</code>	Returns the period of the given animation.
<code>GUI_ANIM_IsRunning()</code>	Returns if an animation is running.
<code>GUI_ANIM_Start()</code>	Sets the start time of the given animation.
<code>GUI_ANIM_StartEx()</code>	Starts the given animation automatically.
<code>GUI_ANIM_StartExId()</code>	Sets the start time of the given animation and processes the animation automatically.
<code>GUI_ANIM_Stop()</code>	Stops the animation correspondig to the given handle.
<code>GUI_ANIM_StopById()</code>	Stops the animation correspondig to the given handle.

### Data structures

Structure	Description
<code>GUI_ANIM_INFO</code>	Contains information about the current state of an animation.

### Defines

Group of defines	Description
<code>Animation states</code>	List of possible states for an animation.

## 6.8.6.1 Functions

### 6.8.6.1.1 GUI\_ANIM\_AddItem()

#### Description

Adds an item to the given animation.

#### Prototype

```
int GUI_ANIM_AddItem(GUI_ANIM_HANDLE      hAnim,
                    GUI_TIMER_TIME       ts,
                    GUI_TIMER_TIME       te,
                    GUI_ANIM_GETPOS_FUNC pfGetPos,
                    void                  * pVoid,
                    GUI_ANIMATION_FUNC   * pfAnim);
```

#### Parameters

Parameter	Description
<code>hAnim</code>	Handle of animation object to be used.
<code>ts</code>	Relative start time in ms.
<code>te</code>	Relative end time in ms. Needs to be > <code>ts</code> .
<code>pfGetPos</code>	Pointer to a routine for calculating the position value.
<code>pVoid</code>	Optional void pointer passed to the animation function during the execution.
<code>pfAnim</code>	Pointer to the animation function (item) to be executed by the object.

#### Return value

0        on success  
1        on error.

#### Additional information

Start and end time are relative to the time value set when calling `GUI_ANIM_Start()`.

### 6.8.6.1.2 GUI\_ANIM\_AddItemById()

#### Description

Adds an item to the given animation.

#### Prototype

```
int GUI_ANIM_AddItemById(I16          Id,
                        GUI_TIMER_TIME ts,
                        GUI_TIMER_TIME te,
                        GUI_ANIM_GETPOS_FUNC pfGetPos,
                        void             * pVoid,
                        GUI_ANIMATION_FUNC * pfAnim);
```

#### Parameters

Parameter	Description
<code>Id</code>	<code>Id</code> of animation object to be used.
<code>ts</code>	Relative start time in ms.
<code>te</code>	Relative end time in ms. Needs to be > <code>ts</code> .
<code>pfGetPos</code>	Pointer to a routine for calculating the position value.
<code>pVoid</code>	Optional void pointer passed to the animation function during the execution.
<code>pfAnim</code>	Pointer to the animation function (item) to be executed by the object.

#### Return value

0        on success  
1        on error.

#### Additional information

Start and end time are relative to the time value set when calling `GUI_ANIM_Start()`.



### 6.8.6.1.3 GUI\_ANIM\_Create()

#### Description

Creates an animation object.

#### Prototype

```
GUI_ANIM_HANDLE GUI_ANIM_Create(GUI_TIMER_TIME   Period,
                                unsigned         MinTimePerSlice,
                                void             * pVoid,
                                void             (* pfSlice)(int , void * ));
```

#### Parameters

Parameter	Description
<code>Period</code>	Duration in ms of the whole animation. Maximum value is 0x20000.
<code>MinTimePerSlice</code>	Minimum time of one animation slice in ms.
<code>pVoid</code>	Optional void pointer passed to the slice callback function and/or the delete function.
<code>pfSlice</code>	Optional slice callback function.

#### Return value

Handle of the animation object or 0 if no memory is available.

#### Additional information

The value `MinTimePerSlice` determines the frame rate when executing the animation with `GUI_ANIM_Exec()`. The given time determines the minimum period between the execution of 2 slices of animation items.

### 6.8.6.1.4 GUI\_ANIM\_CreateWithId()

#### Description

Creates an animation object.

#### Prototype

```
GUI_ANIM_HANDLE GUI_ANIM_CreateWithId(GUI_TIMER_TIME   Period,
                                       unsigned         MinTimePerSlice,
                                       void             * pVoid,
                                       void             (* pfSlice)(int , void * ),
                                       I16              Id);
```

#### Parameters

Parameter	Description
<a href="#">Period</a>	Duration in ms of the whole animation. Maximum value is 0x20000.
<a href="#">MinTimePerSlice</a>	Minimum time of one animation slice in ms.
<a href="#">pVoid</a>	Optional void pointer passed to the slice callback function and/or the delete function.
<a href="#">pfSlice</a>	Optional slice callback function.
<a href="#">Id</a>	<a href="#">Id</a> of the animation.

#### Return value

Handle of the animation object or 0 if no memory is available.

#### Additional information

The value [MinTimePerSlice](#) determines the frame rate when executing the animation with [GUI\\_ANIM\\_Exec\(\)](#). The given time determines the minimum period between the execution of 2 slices of animation items.

### 6.8.6.1.5 GUI\_ANIM\_Delete()

#### Description

Deletes an animation object and all of its data.

#### Prototype

```
void GUI_ANIM_Delete(GUI_ANIM_HANDLE hAnim);
```

#### Parameters

Parameter	Description
<code>hAnim</code>	Handle of animation object to be used.

### 6.8.6.1.6 GUI\_ANIM\_DeleteAll()

#### Description

Deletes all animations. Also calls the deletion function for each animation if it is set.

#### Prototype

```
void GUI_ANIM_DeleteAll(void);
```

### 6.8.6.1.7 GUI\_ANIM\_DeleteById()

#### Description

Deletes an animation object and all of its data.

#### Prototype

```
int GUI_ANIM_DeleteById(I16 Id);
```

#### Parameters

Parameter	Description
<code>Id</code>	<code>Id</code> of animation object to be used.

### 6.8.6.1.8 GUI\_ANIM\_Exec()

#### Description

Should be used to keep the given animation alive. The function needs to be called periodically.

#### Prototype

```
int GUI_ANIM_Exec(GUI_ANIM_HANDLE hAnim);
```

#### Parameters

Parameter	Description
<code>hAnim</code>	Handle of animation object to be used.

#### Return value

- 0 if the given animation is within its timeline.
- 1 if the animation period is expired.

#### Additional information

Within a typical execution loop the application should give other tasks a chance to do something. That can be done by simply calling `GUI_Delay()`.

#### Example

```
while (GUI_ANIM_Exec(hAnim) == 0) {  
    GUI_X_Delay(5); // Idle time for other tasks  
}
```

### 6.8.6.1.9 GUI\_ANIM\_Get()

#### Description

Returns the handle of the given animation.

#### Prototype

```
GUI_ANIM_HANDLE GUI_ANIM_Get ( I16 Id );
```

#### Parameters

Parameter	Description
<a href="#">Id</a>	<a href="#">Id</a> of animation object to be returned.

#### Return value

Handle of animation object, 0 on error.

### 6.8.6.1.10 GUI\_ANIM\_GetData()

#### Description

Returns the optional void pointer passed to the animation with `GUI_ANIM_Create()`.

#### Prototype

```
void *GUI_ANIM_GetData(GUI_ANIM_HANDLE hAnim);
```

#### Parameters

Parameter	Description
<code>hAnim</code>	Animation handle.

#### Return value

Void pointer passed to the animation.



### 6.8.6.1.11 GUI\_ANIM\_GetFirst()

#### Description

Returns the handle of the first animation to be executed automatically.

#### Prototype

```
GUI_ANIM_HANDLE GUI_ANIM_GetFirst(void);
```

### 6.8.6.1.12 GUI\_ANIM\_GetItemData()

#### Description

Returns the optional void pointer passed to an animation item with `GUI_ANIM_AddItem()`.

#### Prototype

```
void *GUI_ANIM_GetItemData(GUI_ANIM_HANDLE hAnim,  
                           unsigned Index);
```

#### Parameters

Parameter	Description
<code>hAnim</code>	Animation handle.
<code>Index</code>	<code>Index</code> of animation item.

#### Return value

Void pointer passed to the animation item.

### 6.8.6.1.13 GUI\_ANIM\_GetNext()

#### Description

Returns the handle of the next animation to be executed after the given animation.

#### Prototype

```
GUI_ANIM_HANDLE GUI_ANIM_GetNext(GUI_ANIM_HANDLE hAnim);
```

#### Parameters

Parameter	Description
<a href="#">hAnim</a>	Animation handle.

#### Return value

Handle of next animation to executed.

#### 6.8.6.1.14 GUI\_ANIM\_GetNumItems()

##### Description

Returns the number of items in an animation.

##### Prototype

```
int GUI_ANIM_GetNumItems(GUI_ANIM_HANDLE hAnim);
```

##### Parameters

Parameter	Description
<code>hAnim</code>	Animation handle.

##### Return value

Number of items present in the given animation.

### 6.8.6.1.15 GUI\_ANIM\_GetPeriod()

#### Description

Returns the period of the given animation.

#### Prototype

```
GUI_TIMER_TIME GUI_ANIM_GetPeriod(GUI_ANIM_HANDLE hAnim);
```

#### Parameters

Parameter	Description
<code>hAnim</code>	Handle of animation object to be used.

#### Return value

Period of the given animation.

### 6.8.6.1.16 GUI\_ANIM\_IsRunning()

#### Description

Returns if an animation is running.

#### Prototype

```
int GUI_ANIM_IsRunning(GUI_ANIM_HANDLE hAnim);
```

#### Parameters

Parameter	Description
<a href="#">hAnim</a>	Animation handle.

#### Return value

- 0 if the animation is not running.
- 1 if the animation is running.

### 6.8.6.1.17 GUI\_ANIM\_Start()

#### Description

Sets the start time of the given animation.

#### Prototype

```
void GUI_ANIM_Start(GUI_ANIM_HANDLE hAnim);
```

#### Parameters

Parameter	Description
<code>hAnim</code>	Handle of animation object to be used.

#### Additional information

The function does nothing but setting the current time as start time. From that moment `GUI_ANIM_Exec()` should return 0 for the given animation period.

### 6.8.6.1.18 GUI\_ANIM\_StartEx()

#### Description

Sets the start time of the given animation and processes the animation automatically.

#### Prototype

```
void GUI_ANIM_StartEx(GUI_ANIM_HANDLE hAnim,
                    int NumLoops,
                    void (*pfOnDelete)(void * pVoid ));
```

#### Parameters

Parameter	Description
<code>hAnim</code>	Handle of animation object to be used.
<code>NumLoops</code>	Number of loops the animation should be executed. -1 causes the animation to run endlessly until it is stopped with <code>GUI_ANIM_Stop()</code> .
<code>pfOnDelete</code>	Function pointer to a function which should be executed on deletion of the animation.

#### Additional information

This function should be used instead of `GUI_ANIM_Start()` since it is no longer necessary to call `GUI_ANIM_Start()` in combination `GUI_ANIM_Exec()` and handle the animation process on your own. `GUI_ANIM_StartEx()` handles the process automatically.



### 6.8.6.1.19 GUI\_ANIM\_StartExId()

#### Description

Sets the start time of the given animation and processes the animation automatically.

#### Prototype

```
int GUI_ANIM_StartExId(I16 Id,
                      int NumLoops,
                      void ( *pfOnDelete)(void * pVoid ));
```

#### Parameters

Parameter	Description
<code>Id</code>	<code>Id</code> of animation object to be used.
<code>NumLoops</code>	Number of loops the animation should be executed. -1 causes the animation to run endlessly until it is stopped with <code>GUI_ANIM_Stop()</code> .
<code>pfOnDelete</code>	Function pointer to a function which should be executed on deletion of the animation.

#### Additional information

This function should be used instead of `GUI_ANIM_Start()` since it is no longer necessary to call `GUI_ANIM_Start()` in combination `GUI_ANIM_Exec()` and handle the animation process on your own. `GUI_ANIM_StartEx()` handles the process automatically.

### 6.8.6.1.20 GUI\_ANIM\_Stop()

#### Description

Stops the animation correspondig to the given handle.

#### Prototype

```
void GUI_ANIM_Stop(GUI_ANIM_HANDLE hAnim);
```

#### Parameters

Parameter	Description
<code>hAnim</code>	Handle of animation object to be used.

### 6.8.6.1.21 GUI\_ANIM\_StopById()

#### Description

Stops the animation correspondig to the given handle.

#### Prototype

```
int GUI_ANIM_StopById(I16 Id);
```

#### Parameters

Parameter	Description
<code>Id</code>	<code>Id</code> of animation object to be used.

#### Return value

0 on success, 1 on error.

## 6.8.6.2 Data structures

### 6.8.6.2.1 GUI\_ANIM\_INFO

#### Description

Contains information about the current state of an animation.

#### Type definition

```
typedef struct {
    int          Pos;
    int          State;
    GUI_ANIM_HANDLE hAnim;
    GUI_TIMER_TIME Period;
    unsigned     Index;
} GUI_ANIM_INFO;
```

#### Structure members

Member	Description
<a href="#">Pos</a>	Position value calculated by the selected position calculation routine.
<a href="#">State</a>	<a href="#">State</a> of the animation. See <i>Animation states</i> on page 781 for valid values.
<a href="#">hAnim</a>	Handle of the animation object.
<a href="#">Period</a>	<a href="#">Period</a> of the animation object.
<a href="#">Index</a>	Item index

## 6.8.6.3 Defines

### 6.8.6.3.1 Animation states

#### Description

Describes the current state of an animation. Sent with the `State` member of the `GUI_ANIM_INFO` structure to an animation callback.

#### Definition

```
#define GUI_ANIM_START      0
#define GUI_ANIM_RUNNING   1
#define GUI_ANIM_END       2
```

#### Symbols

Definition	Description
<code>GUI_ANIM_START</code>	First execution.
<code>GUI_ANIM_RUNNING</code>	Passed to all items which are not the first and not the last.
<code>GUI_ANIM_END</code>	Last execution.

## 6.9 Movies

With the movie file support of emWin it is possible to show movies. The movie file can be in two different formats. Besides our own movie format (EMF) it is also possible to display AVI files.

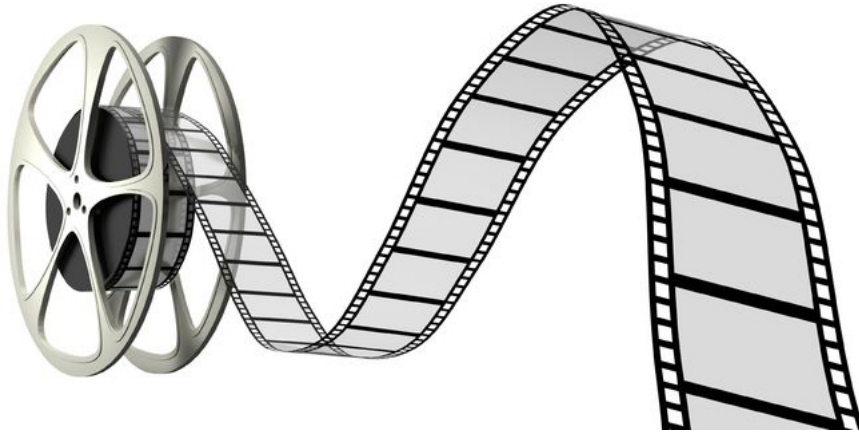

### 6.9.1 Introduction

#### EMF format

One way to play movies with the emWin API functions is to create files of the emWin specific **(E)mWin (M)ovie (F)ile** format. These EMF files are containers for single JPEG files. The most recommended way to create such movie files each emWin-shipment contains the tool MakeMovie in the `\Tools` folder.

#### AVI format

Another way to show movies is to use the AVI format (Audio Video Interleave) which was introduced Microsoft. To be able to show AVI files these files must reside in a specific format. Please refer to *Requirements* on page 79.

The easiest way to create an AVI file which fits the requirements is to use the tool MakeMovie in the `\Tools` folder.

## 6.9.2 Requirements

In opposite to movie file rendering using different frame methods the EMF file format contains complete JPEG files for each frame. The advantage of this format is that not more than one frame is required in memory.

### RAM requirement

For the rendering process of an EMF file it is required to have enough dynamic RAM as required for rendering a single JPEG file plus the file size of a single JPEG file. The RAM requirement for rendering a JPEG file can be found in the chapter *JPEG file support* on page 462.

```
Requirement = JPEG requirement + File size of a single JPEG file
```

Please note that `File size` does not mean the whole movie file. It means the size of the biggest JPEG file of the movie only.

### ROM requirement

Apart from the ROM requirement of the movie file itself approx. 22 KByte of additional ROM for the binary code for rendering JPEG based movie files are required.

### Performance

To achieve a fluently rendering of the movie a frame rate of 25 frames/seconds is recommended.

### AVI files

There are two requirements to be able to display AVI files with emWin.

The codec to be used in AVI file has to be MJPEG and the AVI file has to contain an index list called `idx1` list.

The AVI files can also contain sound files, but these are not handled by emWin, yet.

## 6.9.3 Creating movies using MakeMovie.exe

Each emWin-shipment comes with the tool MakeMovie.exe in the \Tools folder:

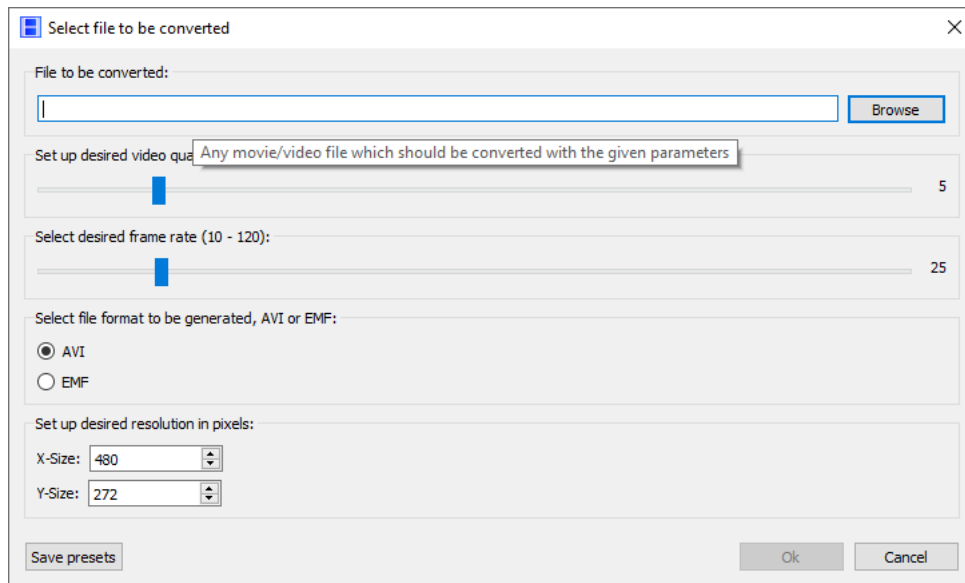

It uses the open source tool FFmpeg which is available under [ffmpeg.org](http://ffmpeg.org). It is free software licensed under the LGPL or GPL. It is able to convert files of nearly any movie file source format into any desired destination format. Because the tool is licensed under the LGPL we do not ship this tool directly. It can be loaded from [ffmpeg.org](http://ffmpeg.org). We recommend version 5.1 or newer.

### 6.9.3.1 Setting up the location of ffmpeg.exe

When starting MakeMovie the first time, the location of ffmpeg.exe needs to be specified:

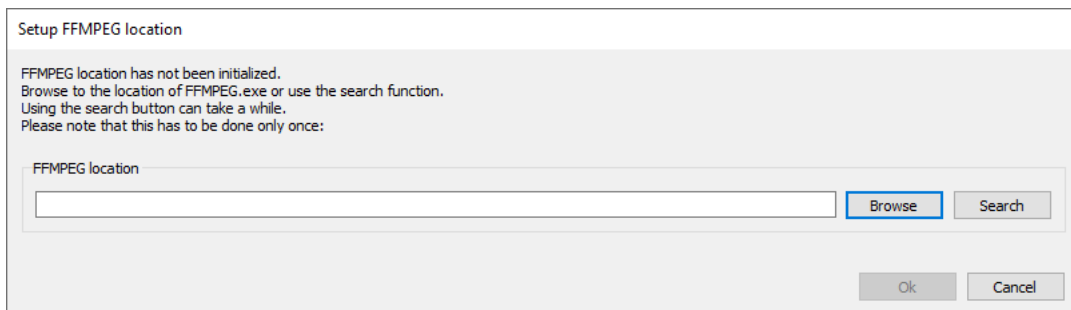

#### Browse

If the location of ffmpeg is known the browse button can be used to locate the executable of the tool.

#### Search

A convenient option to locate ffmpeg.exe is also the search button. It tries to find the tool in the application drive.

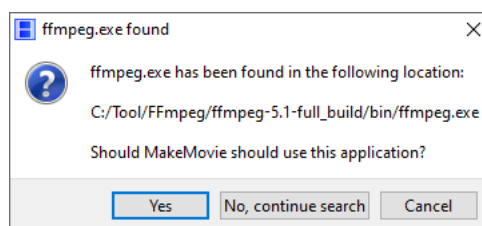

If an executable has been found you can choose it or continue the search.



### 6.9.3.2 Available conversion options

The following options are available:

Option	Description
Video quality (1 - 31)	Set up the desired video quality.
Frame rate (10 - 120 FPS)	Select the desired frame rate.
File format (AVI/EMF)	Select file format to be generated.
Resolution	Set up desired resolution in pixels.
Save presets	Saves the current parameters as default for later conversions.

#### Video quality

Parameter for the sparsely documented option `-q`. Specifies the video quality of the file to be generated.

- 1 - Best quality, largest file size and most decoding effort.
- 31 - Poor quality, smallest file size and smallest decoding effort.

To find the best compromise, we recommend playing with this parameter until a satisfactory quality and decoding performance is found.

#### Frame rate

We have limited the frame rate to a range of 10-120 FPS.

#### File format

It allows to choose one of the former described movie formats.

#### Resolution

We recommend using the same aspect ratio for the movie to be generated and the source video.

### 6.9.3.3 Conversion

Pressing 'Ok' after setting up the parameters the file conversion will be started.

#### Note

The conversion may take more or less time in dependence of the size of the source video and the CPU performance of the host.

After the conversion has been done, a dialog shows the success or failure. The generated file can be found in the same folder than the source file.

The file name is automatically generated according to the following scheme:

```
<BASENAME>_<RESOLUTION_X>_<RESOLUTION_Y>.<SUFFIX>
```

## 6.9.4 Bitmap-EMF files

### About Bitmap-EMFs

Bitmap-based emWin movie files (EMF) have been added to emWin as an alternative format for GIF animations and standard EMFs. The format is composed of bitmap frames which are saved in emWin's DTA format. Since this format makes use of uncompressed bitmaps, the time required for drawing frames is greatly reduced. The format outperforms JPEGs and GIFs, especially on hardware targets, since no encoding of the frames is required.

The format also allows the use of any emWin bitmap format available (except RLE compressed formats), as well as color formats.

#### Note

The bitmap-based EMF format is an **uncompressed** format, therefore the files are intended to be stored on external memory due to the large file size.

### Generating Bitmap-EMFs

Bitmap-EMFs can be generated from GIF animations using the Bitmap Converter. The corresponding chapter provides information about how the files can be converted, see *Converting GIFs into Bitmap-EMFs* on page 3128.

### Memory requirement

As hinted above, the Bitmap-EMF format is quite memory intensive, since it is an uncompressed format aimed at performance. The memory requirement for an EMF file is dependent on the bit depth and bitmap dimensions.

To calculate the memory requirement, the following formula may be used:

```
NumBytesPal      = (NumColors * 4);  
NumBytesPerFrame = (((xSize * Bpp) + 7) / 8) * ySize + NumBytesPal + 16;  
NumBytesEMF     = (NumFrames * NumBytesPerFrame) + (NumFrames * 8) + 24;
```

### Playing a movie

Bitmap-EMFs can be created and run the same way as standard emWin movies using `GUI_MOVIE_CreateEx()` and `GUI_MOVIE_Show()`.

### 6.9.4.1 Sample program to run EMF from external memory

The sample program below runs EMF files from external memory under both the Windows simulation and on a hardware target using emFile.

```
#include "DIALOG.h"
#include <stdio.h>
#ifdef WIN32
    #include <windows.h>
#else
    #include "FS.h"
#endif

/*****
 *
 *      Defines
 *
 *****/
#ifdef WIN32
    #define FILE_PATH "c:\\Temp\\Anim.emf"
#else
    #define FILE_PATH "Anim.emf"
#endif

/*****
 *
 *      Static data
 *
 *****/

/*****
 *
 *      Static code
 *
 *****/
/*****
 *
 *      _GetData
 *
 *      Function description
 *      Reading data directly from file system
 */
int _GetData(void * p, const U8 ** ppData, unsigned NumBytes, U32 Off) {
    U32 NumBytesRead;
#ifdef WIN32
    HANDLE hFile;

    hFile = *(HANDLE *)p;
    SetFilePointer(hFile, Off, 0, FILE_BEGIN);
    ReadFile(hFile, (U8 *)*ppData, NumBytes, &NumBytesRead, NULL);
#else
    FS_FILE * pFile;

    pFile = (FS_FILE *)p;
    FS_SetFilePos(pFile, Off, FS_FILE_BEGIN);
    NumBytesRead = FS_Read(pFile, (U8 *)*ppData, NumBytes);
#endif
    return NumBytesRead;
}

/*****
 *
 *      _cbNotify
 *
 *****/
```

```

* Function description
*   Uses multiple buffering (if available) to avoid tearing effects.
*/
static void _cbNotify(GUI_HMEM hMovie, int Notification, U32 CurrentFrame) {
    GUI_USE_PARA(hMovie);
    GUI_USE_PARA(CurrentFrame);
    switch (Notification) {
        case GUI_MOVIE_NOTIFICATION_PREDRAW:
            //
            // Begin multi-buffering if available.
            //
            GUI_MULTIBUF_Begin();
            break;
        case GUI_MOVIE_NOTIFICATION_POSTDRAW:
        case GUI_MOVIE_NOTIFICATION_PREDRAW:
            //
            // End multi-buffering.
            //
            GUI_MULTIBUF_End();
            break;
        case GUI_MOVIE_NOTIFICATION_START:
            break;
        case GUI_MOVIE_NOTIFICATION_STOP:
            break;
    }
}

/*****
*
*   Public code
*
*****/
*/
/*****
*
*   MainTask
*
*****/
void MainTask(void) {
    GUI_MOVIE_HANDLE hMovie;
    GUI_MOVIE_INFO Info;
#ifdef WIN32
    HANDLE hFile;
    #define PARAM &hFile
#else
    FS_FILE * pFile;
    const char acVolumeName[64];
    #define PARAM pFile
#endif

    //
    // Init emWin.
    //
    GUI_Init();
    GUI_Clear();

#ifdef WIN32
    hFile = CreateFile(FILE_PATH, GENERIC_READ, 0, 0, OPEN_EXISTING, FILE_ATTRIBUTE_NORMAL, 0);
#else
    //
    // Start emFile.
    //
    FS_Init();
    //
    // Enable long file name support.
    //
    FS_FAT_SupportLFN();
    //
    // Mount volume.

```

```
//
FS_GetVolumeName(0, acVolumeName, sizeof(acVolumeName));
if (FS_Mount(acVolumeName) > 0) {
    //
    // Open file.
    //
    pFile = FS_FOpen(FILE_PATH, "r");
}
#endif
//
// Get info about movie.
//
if(GUI_MOVIE_GetInfoEx(_GetData, PARAM, &Info) == 0) {
    //
    // Create movie handle and show it in an endless loop.
    //
    hMovie = GUI_MOVIE_CreateEx(_GetData, PARAM, _cbNotify);
    if (hMovie) {
        GUI_MOVIE_Show(hMovie, 0, 0, 1);
    }
}

while (1) {
    GUI_Delay(100);
}

/***** End of file *****/
```

## 6.9.5 emWin Movie Player

Every emWin shipment comes with a tool named emWinPlayer. This tool makes it possible to show the previously created EMF on a Computer with a Windows operating system. This might come in handy since there is no need of a running application to watch the created EMF.

When using the emWinPlayer it provides the user with information about the currently running EMF. It shows the currently displayed frame and the time of this frame. This will make it easier to change the movie at a specific position.

To show an EMF either open a file via the menu bar or 'drag and drop' the file to be played into the player. The EMF starts playing automatically. The control panel allows to jump at the beginning or the end of movie, step frame wise and to play/pause the movie file. With a click on the progress bar it is also possible to jump to a position in the movie.

### Limitations

The emWin movie player does not yet support bitmap-based EMFs.

### Screenshot of the tool



## 6.9.6 Movies API

The table below lists the available movie-related routines in alphabetical order. Detailed descriptions follow:

### Functions

Routine	Description
<code>GUI_MOVIE_Create()</code>	Creates a movie using a file which is completely available in addressable RAM or ROM.
<code>GUI_MOVIE_CreateEx()</code>	Creates a movie using a file which is not available in addressable RAM or ROM.
<code>GUI_MOVIE_Delete()</code>	Deletes the given movie from memory.
<code>GUI_MOVIE_DrawFrame()</code>	Draws a single frame of a movie.
<code>GUI_MOVIE_GetFrameIndex()</code>	Returns the current frame number of the given movie.
<code>GUI_MOVIE_GetInfo()</code>	Fills a <code>GUI_MOVIE_INFO</code> structure with information about the given movie.
<code>GUI_MOVIE_GetInfoEx()</code>	Fills a <code>GUI_MOVIE_INFO</code> structure with information about the given movie not being available in RAM or ROM.
<code>GUI_MOVIE_GetInfoH()</code>	Fills a <code>GUI_MOVIE_INFO</code> structure with information about the given movie using an existing movie handle.
<code>GUI_MOVIE_GetNumFrames()</code>	Returns the number of frames of a movie.
<code>GUI_MOVIE_GetPos()</code>	Returns the drawing position and resolution of the given movie.
<code>GUI_MOVIE_GotoFrame()</code>	Sets the frame index to be shown at next.
<code>GUI_MOVIE_IsPlaying()</code>	Returns if the given movie is currently playing.
<code>GUI_MOVIE_Pause()</code>	Stops playing the given movie immediately.
<code>GUI_MOVIE_Play()</code>	Continues playing of the given movie.
<code>GUI_MOVIE_SetPeriod()</code>	Sets the period to be used for one single frame in ms.
<code>GUI_MOVIE_SetpfNotify()</code>	Set a notification callback function.
<code>GUI_MOVIE_SetPos()</code>	Sets the drawing position to be used for the given movie.
<code>GUI_MOVIE_SetSecondHandle()</code>	This function sets an optional second void pointer.
<code>GUI_MOVIE_Show()</code>	Starts playing the given movie at the given position.

### Data structures

Structure	Description
<code>GUI_MOVIE_INFO</code>	Information about a movie.

### Defines

Group of defines	Description
<code>Movie notifications</code>	Notifications sent to the movie's callback function.

## Prototypes

Prototype	Description
<a href="#">GUI_MOVIE_GET_DATA_FUNC</a>	GetData function used for emWin movie files (EMF), for more details see <a href="#">GUI_GET_DATA_FUNC_II</a> .



## 6.9.6.1 Functions

### 6.9.6.1.1 GUI\_MOVIE\_Create()

#### Description

Creates a movie using a file which is completely available in addressable RAM or ROM.

#### Prototype

```
GUI_MOVIE_HANDLE GUI_MOVIE_Create(const void          * pFileData,
                                  U32                FileSize,
                                  GUI_MOVIE_FUNC * pfNotify);
```

#### Parameters

Parameter	Description
<code>pFileData</code>	Pointer to the memory location of the file.
<code>FileSize</code>	Size of file in bytes.
<code>pfNotify</code>	Optional pointer to a notification function of type <code>GUI_MOVIE_FUNC</code> . If set, this function would be called for each frame.

#### Prototype of GUI\_MOVIE\_FUNC

```
void GUI_MOVIE_FUNC(GUI_MOVIE_HANDLE hMovie,
                    int               Notification,
                    U32               CurrentFrame);
```

The permitted values for the `Notification` parameter are listed under *Movie notifications* on page 813.

#### Return value

Movie handle on success, 0 on error.

#### Additional information

The callback function can be used to achieve overlays for specific frames or for using multiple buffers for the drawing process. The sample folder contains the sample `BASIC_ShowMovies.c` which shows how to use that feature in detail.

### 6.9.6.1.2 GUI\_MOVIE\_CreateEx()

#### Description

Creates a movie using a file which is not available in addressable RAM or ROM. A user defined GetData() function is used to fetch the file data.

#### Prototype

```
GUI_MOVIE_HANDLE GUI_MOVIE_CreateEx(GUI_MOVIE_GET_DATA_FUNC * pfGetData,
                                   void * pParam,
                                   GUI_MOVIE_FUNC * pfNotify);
```

#### Parameters

Parameter	Description
<code>pfGetData</code>	<b>in</b> Function pointer to a GetData function. For more details, please refer to the chapter <i>FileAccess</i> on page 3219.
<code>pParam</code>	<b>in</b> Void pointer passed to the function pointed by <code>pfGetData</code> .
<code>pfNotify</code>	<b>in</b> Optional pointer to a notification function as described under <code>GUI_MOVIE_Create()</code> .

#### Return value

Movie handle on success, 0 on error.

#### Additional information

When playing a movie not from an addressable memory location, the movie function of emWin reads the file frame by frame. That means that only one file access is required for each frame. But that also means that enough RAM needs to be available for buffering a complete JPEG file. For more information please also refer to `GUI_MOVIE_Create()`.

### 6.9.6.1.3 GUI\_MOVIE\_Delete()

#### Description

Deletes the given movie from memory.

#### Prototype

```
int GUI_MOVIE_Delete(GUI_MOVIE_HANDLE hMovie);
```

#### Parameters

Parameter	Description
<code>hMovie</code>	Handle to the movie to be deleted.

#### Return value

0        on success  
1        on error.

#### Additional information

If the movie is currently playing, the function stops it. It is not required to call `GUI_MOVIE_Pause()` explicitly.

#### 6.9.6.1.4 GUI\_MOVIE\_DrawFrame()

##### Description

Draws the given frame of the movie at the given position.

##### Prototype

```
void GUI_MOVIE_DrawFrame(GUI_MOVIE_HANDLE hMovie,  
                          int             Index,  
                          int             x,  
                          int             y);
```

##### Parameters

Parameter	Description
<a href="#">hMovie</a>	Handle to the movie to be deleted.
<a href="#">Index</a>	<a href="#">Index</a> of the frame to be shows.
<a href="#">x</a>	X-position in screen coordinates to be used.
<a href="#">y</a>	Y-position in screen coordinates to be used.

### 6.9.6.1.5 GUI\_MOVIE\_GetFrameIndex()

#### Description

If the movie is already playing the function returns the index of the next frame to be shown. If the movie is currently stopped/paused, it returns the frame index of the last shown image.

#### Prototype

```
U32 GUI_MOVIE_GetFrameIndex(GUI_MOVIE_HANDLE hMovie);
```

#### Parameters

Parameter	Description
<a href="#">hMovie</a>	Handle to the movie to be deleted.

#### Return value

Frame index as described above.

### 6.9.6.1.6 GUI\_MOVIE\_GetInfo()

#### Description

Fills a `GUI_MOVIE_INFO` structure with information about the given movie. The movie needs to be available in an addressable memory location.

#### Prototype

```
int GUI_MOVIE_GetInfo(const void      * pFileData,  
                     U32             FileSize,  
                     GUI_MOVIE_INFO * pInfo);
```

#### Parameters

Parameter	Description
<code>pFileData</code>	Pointer to the memory location of the file.
<code>FileSize</code>	Size of file in bytes.
<code>pInfo</code>	Pointer to a structure of type <code>GUI_MOVIE_INFO</code> to be filled by the function.

#### Return value

0        on success  
1        on error.

### 6.9.6.1.7 GUI\_MOVIE\_GetInfoEx()

#### Description

Fills a `GUI_MOVIE_INFO` structure with information about the given movie. The movie does not need to be available in an addressable memory location.

#### Prototype

```
int GUI_MOVIE_GetInfoEx(GUI_MOVIE_GET_DATA_FUNC * pfGetData,
                       void * pParam,
                       GUI_MOVIE_INFO * pInfo);
```

#### Parameters

Parameter	Description
<code>pfGetData</code>	<b>in</b> Function pointer to a <code>GetData</code> function. For more details, please refer to the chapter <i>FileAccess</i> on page 3219.
<code>pParam</code>	<b>in</b> Void pointer passed to the function pointed by <code>pfGetData</code> .
<code>pInfo</code>	<b>out</b> Pointer to a structure of type <code>GUI_MOVIE_INFO</code> to be filled by the function.

#### Return value

0        on success  
1        on error.

### 6.9.6.1.8 GUI\_MOVIE\_GetInfoH()

#### Description

Fills a `GUI_MOVIE_INFO` structure with information about the given movie using an existing movie handle.

#### Prototype

```
int GUI_MOVIE_GetInfoH(GUI_MOVIE_HANDLE hMovie,  
                      GUI_MOVIE_INFO * pInfo);
```

#### Parameters

Parameter	Description
<code>hMovie</code>	Handle of the movie.
<code>pInfo</code>	Pointer to a structure of type <code>GUI_MOVIE_INFO</code> to be filled by the function.

#### Return value

0        on success  
1        on error.



### 6.9.6.1.9 GUI\_MOVIE\_GetNumFrames()

#### Description

Returns the number of frames of a movie.

#### Prototype

```
int GUI_MOVIE_GetNumFrames(GUI_MOVIE_HANDLE hMovie);
```

#### Parameters

Parameter	Description
<a href="#">hMovie</a>	Handle of the movie.

#### Return value

Number of frames present in the movie.

### 6.9.6.1.10 GUI\_MOVIE\_GetPos()

#### Description

Returns the drawing position and resolution of the given movie.

#### Prototype

```
int GUI_MOVIE_GetPos(GUI_MOVIE_HANDLE hMovie,
                    int                * pxPos,
                    int                * pyPos,
                    int                * pxSize,
                    int                * pySize);
```

#### Parameters

Parameter	Description
<code>hMovie</code>	Handle of the movie.
<code>pxPos</code>	Pointer to an integer to be filled with the drawing position in x. May be <code>NULL</code> .
<code>pyPos</code>	Pointer to an integer to be filled with the drawing position in y. May be <code>NULL</code> .
<code>pxSize</code>	Pointer to an integer to be filled with the horizontal resolution in x. May be <code>NULL</code> .
<code>pySize</code>	Pointer to an integer to be filled with the horizontal resolution in y. May be <code>NULL</code> .

#### Return value

0        on success  
1        on error.

### 6.9.6.1.11 GUI\_MOVIE\_GotoFrame()

#### Description

Sets the frame index to be shown at next.

#### Prototype

```
int GUI_MOVIE_GotoFrame(GUI_MOVIE_HANDLE hMovie,  
                        U32                Frame);
```

#### Parameters

Parameter	Description
<code>hMovie</code>	Handle of the movie.
<code>Frame</code>	Number of the desired frame.

#### Return value

0        on success  
1        on error.

#### Additional information

If the given frame index is not in the range of the given file, the function stops the movie and returns with an error.

### 6.9.6.1.12 GUI\_MOVIE\_IsPlaying()

#### Description

Returns if the given movie is currently playing.

#### Prototype

```
int GUI_MOVIE_IsPlaying(GUI_MOVIE_HANDLE hMovie);
```

#### Parameters

Parameter	Description
<a href="#">hMovie</a>	Handle of the movie.

#### Return value

- 1 Movie is playing active
- 0 Movie is not playing.
- 1 On error.

### 6.9.6.1.13 GUI\_MOVIE\_Pause()

#### Description

Stops playing the given movie immediately. Can be continued later with `GUI_MOVIE_Play()`.

#### Prototype

```
int GUI_MOVIE_Pause(GUI_MOVIE_HANDLE hMovie);
```

#### Parameters

Parameter	Description
<code>hMovie</code>	Handle of the movie.

#### Return value

0        on success  
1        on error.

### 6.9.6.1.14 GUI\_MOVIE\_Play()

#### Description

Continues playing of the given movie.

#### Prototype

```
int GUI_MOVIE_Play(GUI_MOVIE_HANDLE hMovie);
```

#### Parameters

Parameter	Description
<a href="#">hMovie</a>	Handle of the movie.

#### Return value

0        on success  
1        on error.

### 6.9.6.1.15 GUI\_MOVIE\_SetPeriod()

#### Description

Sets the period to be used for one single frame in ms.

#### Prototype

```
int GUI_MOVIE_SetPeriod(GUI_MOVIE_HANDLE hMovie,  
                        unsigned          Period);
```

#### Parameters

Parameter	Description
<code>hMovie</code>	Handle of the movie.
<code>Period</code>	<code>Period</code> to be used in ms.

#### Return value

0        on success  
1        on error.

#### Additional information

This function can be used to vary the speed of a movie. If the period is too short to be achieved by the hardware emWin skips the next image(s).

### 6.9.6.1.16 GUI\_MOVIE\_SetpfNotify()

#### Description

This function should be used when the JPEG decoding is performed by hardware. `GUI_MOVIE_SetpfNotify()` sets a callback function to signalize if a movie is running or not. An example on how to use this function can be found under `Sample\JPEG-Conf\STM32F769`. Further it is required to set up hardware decoding by hardware. Please refer to *Using hardware JPEG decoding* on page .

#### Prototype

```
void GUI_MOVIE_SetpfNotify(GUI_MOVIE_FUNC * pfNotify);
```

#### Parameters

Parameter	Description
<code>hMovie</code>	Handle of the movie.
<code>Period</code>	<code>Period</code> to be used in ms.

#### Return value

0        on success  
1        on error.

#### Additional information

The parameter `pfNotify` has the same prototype as described at *Prototype of GUI\_MOVIE\_FUNC*. Although it has the same prototype, it has not the functionality. The intention of this function pointer is to signal when a movie starts and ends.



### 6.9.6.1.17 GUI\_MOVIE\_SetPos()

#### Description

Sets the drawing position to be used for the given movie.

#### Prototype

```
int GUI_MOVIE_SetPos(GUI_MOVIE_HANDLE hMovie,  
                    int               xPos,  
                    int               yPos);
```

#### Parameters

Parameter	Description
<code>hMovie</code>	Handle of the movie.
<code>xPos</code>	X-position in screen coordinates to be used.
<code>yPos</code>	Y-position in screen coordinates to be used.

#### Return value

0        on success  
1        on error.

#### Additional information

It is not required that the given position makes the movie completely visible. It can be partly or completely outside of the visible screen.

### 6.9.6.1.18 GUI\_MOVIE\_SetSecondHandle()

#### Description

This function sets an optional second void pointer. This is used in order to avoid stuttering of the movie when playing long movie files.

Stuttering could be caused by moving the file pointer from the beginning to the end area of the file and vice versa. The file pointer is moved large distances in big files when frames and offset tables are read which are far apart.

Using a second file pointer for accessing the offset table usually helps with this stuttering problem.

You only have to open the movie file twice in read mode. This second file handle is passed to this function and the `GetData()` function will get passed the second pointer if it is set and offsets are being read.

#### Prototype

```
void GUI_MOVIE_SetSecondHandle(GUI_MOVIE_HANDLE hMovie,
                               void * pParamTable);
```

#### Parameters

Parameter	Description
<code>hMovie</code>	Handle of the movie.
<code>pParamTable</code>	<b>in</b> Void pointer passed to the <code>GetData()</code> function when accessing offset table.

### 6.9.6.1.19 GUI\_MOVIE\_Show()

#### Description

Starts playing the given movie at the given position.

#### Prototype

```
int GUI_MOVIE_Show(GUI_MOVIE_HANDLE hMovie,  
                  int                xPos,  
                  int                yPos,  
                  int                DoLoop);
```

#### Parameters

Parameter	Description
<a href="#">hMovie</a>	Handle of the movie.
<a href="#">xPos</a>	X-position in screen coordinates to be used.
<a href="#">yPos</a>	Y-position in screen coordinates to be used.
<a href="#">DoLoop</a>	1 if the movie should be shown in an endless loop, 0 if not.

#### Return value

0        on success  
1        on error.

#### Additional information

If the given movie is already playing the function returns an error. But the movie remains playing.

## 6.9.6.2 Data structures

### 6.9.6.2.1 GUI\_MOVIE\_INFO

#### Description

Information about a movie.

#### Type definition

```
typedef struct {  
    int  xSize;  
    int  ySize;  
    int  msPerFrame;  
    U32  NumFrames;  
} GUI_MOVIE_INFO;
```

#### Structure members

Member	Description
<a href="#">xSize</a>	Horizontal resolution of the movie in pixels.
<a href="#">ySize</a>	Vertical resolution of the movie in pixels.
<a href="#">msPerFrame</a>	Period of one frame in ms.
<a href="#">NumFrames</a>	Number of frames of the movie file.

#### See also

- [GUI\\_MOVIE\\_GetInfo\(\)](#)
- [GUI\\_MOVIE\\_GetInfoEx\(\)](#)

## 6.9.6.3 Defines

### 6.9.6.3.1 Movie notifications

#### Description

Notifications sent to the movie's callback function. The callback function can be set with `GUI_MOVIE_SetpfNotify()`.

#### Definition

```
#define GUI_MOVIE_NOTIFICATION_PREDRAW      0
#define GUI_MOVIE_NOTIFICATION_POSTDRAW    1
#define GUI_MOVIE_NOTIFICATION_START       2
#define GUI_MOVIE_NOTIFICATION_STOP        3
#define GUI_MOVIE_NOTIFICATION_DELETE      4
```

#### Symbols

Definition	Description
<a href="#">GUI_MOVIE_NOTIFICATION_PREDRAW</a>	Sent immediately before a frame is drawn.
<a href="#">GUI_MOVIE_NOTIFICATION_POSTDRAW</a>	Sent immediately after a frame is drawn.
<a href="#">GUI_MOVIE_NOTIFICATION_START</a>	Sent when starting to play a movie.
<a href="#">GUI_MOVIE_NOTIFICATION_STOP</a>	Sent when the movie has stopped.
<a href="#">GUI_MOVIE_NOTIFICATION_DELETE</a>	Sent when the movie has been deleted.

## 6.9.6.4 Prototypes

### 6.9.6.4.1 GUI\_MOVIE\_GET\_DATA\_FUNC

#### Description

GetData function used for emWin movie files (EMF), for more details see GUI\_GET\_DATA\_FUNC\_II.

#### Type definition

```
typedef GUI_GET_DATA_FUNC_II GUI_MOVIE_GET_DATA_FUNC;
```

## 6.10 Pointer Input Devices

emWin provides support for pointer-input-devices. Pointer input devices can be touch-screen, mouse or joystick. The basic emWin package includes a driver for analog touch-screens, a PS2 mouse driver, as well as an example joystick driver. Other types of touch-panel and mouse devices can also be used with the appropriate drivers.

The software for input devices is located in the subdirectory `GUI\Core`.

### 6.10.1 Description

Pointer input devices are devices such as mice, touch-screens and joysticks. Multiple pointer input devices can be used in a single application to enable simultaneous mouse/touch-screen/joystick use. Basically all a PID driver does is calling the routine `GUI_PID_StoreState()` whenever an event (such as a moved mouse, or a pressed touch screen) has been detected.

PID events are stored in a FIFO which is processed by the Window Manager. If the Window Manager is not used (respectively deactivated), the application is responsible for reacting on PID events.

### 6.10.2 Pointer input device API

The table below lists the pointer input device routines in alphabetical order. Detailed descriptions follow.

#### Note

This API is used by the PID-driver; if you use a PID-driver shipped with emWin, your code does not need to call these routines.

#### Functions

Routine	Description
<code>GUI_PID_GetCurrentState()</code>	Fills the given <code>GUI_PID_STATE</code> structure with the most recently stored PID state.
<code>GUI_PID_GetState()</code>	Fills the given <code>GUI_PID_STATE</code> structure with the current state information and returns if the input device is currently pressed.
<code>GUI_PID_IsEmpty()</code>	Returns if the PID buffer is empty.
<code>GUI_PID_IsPressed()</code>	Returns if the most recent state of the PID is pressed.
<code>GUI_PID_SetHook()</code>	Sets an optional function to be called immediately before storing a new PID event into the input buffer.
<code>GUI_PID_StoreState()</code>	Stores the current state of the pointer input device.

#### Data structures

Structure	Description
<code>GUI_PID_STATE</code>	Stores the position of the pointer input device.

## 6.10.2.1 Functions

### 6.10.2.1.1 GUI\_PID\_GetCurrentState()

#### Description

Fills the given `GUI_PID_STATE` structure with the most recently stored PID state.

#### Prototype

```
void GUI_PID_GetCurrentState(GUI_PID_STATE * pState);
```

#### Parameters

Parameter	Description
<code>pState</code>	Pointer to a <code>GUI_PID_STATE</code> structure.

#### Additional information

This function performs a non-destructive read on the PID FIFO.



### 6.10.2.1.2 GUI\_PID\_GetState()

#### Description

Fills the given `GUI_PID_STATE` structure with the current state information and returns if the input device is currently pressed.

#### Prototype

```
int GUI_PID_GetState(GUI_PID_STATE * pState);
```

#### Parameters

Parameter	Description
<code>pState</code>	Pointer to a <code>GUI_PID_STATE</code> structure.

#### Return value

1 if input device is currently pressed  
0 if not pressed.

#### Additional information

This function does a destructive read on the `PID FIFO`: If the `FIFO` contains unread values, it reads and eliminates the first value in the `FIFO`. If the `FIFO` is empty, it returns the last value written to it. If no value has ever been written into the `PID FIFO`, all values in `pState` are set to 0.

#### Example

```
GUI_PID_STATE State;  
GUI_PID_GetState(&State);
```

### 6.10.2.1.3 GUI\_PID\_IsEmpty()

#### Description

Returns if the PID buffer is empty.

#### Prototype

```
int GUI_PID_IsEmpty(void);
```

#### Return value

- 1 if the PID buffer is empty.
- 0 if entries were found in the PID buffer.

#### 6.10.2.1.4 GUI\_PID\_IsPressed()

##### Description

Returns if the most recent state of the PID is pressed.

##### Prototype

```
int GUI_PID_IsPressed(void);
```

##### Return value

1        if input device is currently pressed  
0        if not pressed.

##### Additional information

This function does not modify the `PID FIFO`.

### 6.10.2.1.5 GUI\_PID\_SetHook()

#### Description

Sets an optional function to be called immediately before storing a new PID event into the input buffer.

#### Prototype

```
void GUI_PID_SetHook(void ( *pfHook)(GUI_PID_STATE * ));
```

#### Parameters

Parameter	Description
<code>pfHook</code>	Pointer to a function which is called immediately before a new PID event is added to the input buffer.

#### Additional information

This function is usefull if it is required to have widgets within multiple layers. Dependent on the given coordinates the element 'Layer' could be modified before the data is added to the input buffer. Please be aware that this function is called by directly by `GUI_PID_StoreState()`. In case of using a touch ISR it is called from that ISR. Calling further GUI functions within the hook function is not allowed. Please keep in mind that this function can be called very often and keep the workload low.

### 6.10.2.1.6 GUI\_PID\_StoreState()

#### Description

Stores the current state of the pointer input device.

#### Prototype

```
void GUI_PID_StoreState(const GUI_PID_STATE * pState);
```

#### Parameters

Parameter	Description
<code>pState</code>	Pointer to a structure of type <code>GUI_PID_STATE</code> .

#### Additional information

This function can be used from an interrupt service routine. The PID input manager of emWin contains a FIFO buffer which is able to hold up to 5 PID events per default. If a different size is required this value can be changed. Details can be found in the section *Advanced GUI configuration options* on page 138.

## 6.10.2.2 Data structures

### 6.10.2.2.1 GUI\_PID\_STATE

#### Description

Stores the position of the pointer input device.

#### Type definition

```
typedef struct {
    int    x;
    int    y;
    U8     Pressed;
    U8     Layer;
} GUI_PID_STATE;
```

#### Structure members

Member	Description
<code>x</code>	Horizontal position of the PID in window coordinates.
<code>y</code>	Vertical position of the PID in window coordinates.
<code>Pressed</code>	<p>If the message is originated by a touch screen this value can be 0 (unpressed) or 1 (pressed).</p> <p>If the message is originated by a mouse each bit represents a mouse button (0 for unpressed and 1 for pressed state):</p> <ul style="list-style-type: none"> <li>• Bit 0 represents the first button (normally the left button)</li> <li>• Bit 1 represents the second button (normally the right button)</li> <li>• Bit 2 represents the third button (normally the middle button)</li> </ul> <p>The remaining bits can be used for further buttons.</p>
<code>Layer</code>	ID of layer.

## 6.10.3 Mouse driver

Mouse support consists of two “layers”: a generic layer and a mouse driver layer. Generic routines refer to those functions which always exist, no matter what type of mouse driver you use. The available mouse driver routines, on the other hand, will call the appropriate generic routines as necessary, and may only be used with the PS2 mouse driver supplied with emWin. If you write your own driver, it is responsible for calling the generic routines.

The generic mouse routines will in turn call the corresponding PID routines.

### 6.10.3.1 Generic mouse driver API

The table below lists the generic mouse routines in alphabetical order. These functions may be used with any type of mouse driver. Detailed descriptions follow.

Routine	Description
<a href="#">GUI_MOUSE_GetState()</a>	Returns the current state of the mouse.
<a href="#">GUI_MOUSE_StoreState()</a>	Stores the current state of the mouse.

### 6.10.3.1.1 GUI\_MOUSE\_GetState()

#### Description

Returns the current state of the mouse.

#### Prototype

```
int GUI_MOUSE_GetState(GUI_PID_STATE * pState);
```

#### Parameters

Parameter	Description
<code>pState</code>	Pointer to a structure of type <code>GUI_PID_STATE</code> .

#### Return value

1 if mouse is currently pressed.  
0 if not pressed.

#### Additional information

This function will call `GUI_PID_GetState()`.



### 6.10.3.1.2 GUI\_MOUSE\_StoreState()

#### Description

Stores the current state of the mouse.

#### Prototype

```
void GUI_MOUSE_StoreState(const GUI_PID_STATE * pState);
```

#### Parameters

Parameter	Description
<code>pState</code>	Pointer to a structure of type <code>GUI_PID_STATE</code> .

#### Additional information

This function will call `GUI_PID_StoreState()`. This function can be used from an interrupt service routine.

#### Example

```
GUI_PID_STATE State;
State.x = _MousepositionX; /* Screen position in X of mouse device */
State.y = _MousepositionY; /* Screen position in Y of mouse device */
State.Pressed = 0;
if (_LeftButtonPressed) {
    State.Pressed |= 1; /* Set bit 0 if left button is pressed */
}
if (_RightButtonPressed) {
    State.Pressed |= 2; /* Set bit 1 if right button is pressed */
}
GUI_MOUSE_StoreState(&State);
```

### 6.10.3.2 PS2 mouse driver

The driver supports any type of PS2 mouse

#### 6.10.3.2.1 Using the PS2 mouse driver

The driver is very easy to use. In the startup code, the initialization function `GUI_MOUSE_DRIVER_PS2_Init()` should be called. The application should somehow notice when a byte is received from the mouse. When this happens, the function `GUI_MOUSE_DRIVER_PS2_OnRx()` should be called and the byte received passed as parameter. The driver in turn then calls `GUI_PID_StoreState` as required. The reception of the byte is typically handled in an interrupt service routine.

An example ISR could look as follows: (Note that this is of course different for different systems)

```
void interrupt OnRx(void) {
    char Data;
    Data = UART_REG;           // Read data from the hardware
    GUI_MOUSE_DRIVER_PS2_OnRx(Data); // Pass it on to the driver
}
```

#### 6.10.3.2.2 PS2 mouse driver API

The table below lists the available mouse driver routines in alphabetical order.

Routine	Description
<code>GUI_MOUSE_DRIVER_PS2_Init()</code>	Initializes the mouse driver.
<code>GUI_MOUSE_DRIVER_PS2_OnRx()</code>	Must be called from receive interrupt routines.

### 6.10.3.2.2.1 GUI\_MOUSE\_DRIVER\_PS2\_Init()

#### Description

Initializes the mouse driver.

#### Prototype

```
void GUI_MOUSE_DRIVER_PS2_Init(void);
```

### 6.10.3.2.2 GUI\_MOUSE\_DRIVER\_PS2\_OnRx()

#### Description

Must be called from receive interrupt routines.

#### Prototype

```
void GUI_MOUSE_DRIVER_PS2_OnRx(unsigned char Data);
```

#### Parameters

Parameter	Description
Data	Byte of data received by ISR.

#### Additional information

The PS2 mouse driver is a serial driver, meaning it receives 1 byte at a time. You need to ensure that this function is called from your receive interrupt routine every time a byte (1 character) is received.

## 6.10.4 Touch screen driver

A touch screen driver will typically simply call `GUI_PID_StoreState()` as described earlier. Any type of touch screen can be supported this way. It is the responsibility of the user to write the driver code (which is usually fairly simple).

The most common way of interfacing a touch screen is the 4-pin analog interface, for which a driver is supplied.

### 6.10.4.1 Generic touch screen API

The generic touch screen API is used with any type of driver (analog, digital, etc.). A driver calls the appropriate routines as necessary. If you write your own driver, it has to call the generic routines.

The table below lists the generic touch-screen routines in alphabetical order. These functions may be used with any type of touch-screen driver. Detailed descriptions follow.

Routine	Description
<code>GUI_TOUCH_GetState()</code>	Returns the current state of the touch-screen.
<code>GUI_TOUCH_StoreState()</code>	Stores the current state of the touch screen using X- and Y-coordinates as parameters.
<code>GUI_TOUCH_StoreStateEx()</code>	Stores the current state of the touch screen.

### 6.10.4.1.1 GUI\_TOUCH\_GetState()

#### Description

Returns the current state of the touch-screen.

#### Prototype

```
int GUI_TOUCH_GetState(GUI_PID_STATE * pState);
```

#### Parameters

Parameter	Description
<code>pState</code>	Pointer to a structure of type <code>GUI_PID_STATE</code> .

#### Return value

- 1 if touch-screen is currently pressed.
- 0 if not pressed.

### 6.10.4.1.2 GUI\_TOUCH\_StoreState()

#### Description

Stores the current state of the touch screen using X- and Y-coordinates as parameters.

#### Prototype

```
void GUI_TOUCH_StoreState(int x,  
                          int y);
```

#### Parameters

Parameter	Description
x	X-position.
y	Y-position.

#### Additional information

This function can be used from an interrupt service routine. It calls the function GUI\_PID\_StoreState(). It is assumed that the touch panel is not pressed, if this function is called with negative values. A detailed example of a touch handling routine can be found in Sample\GUI\_X\GUI\_X\_Touch\_StoreState.c.

#### Example

```
int x, y;  
if (_TouchIsPressed) {  
    x = _TouchPositionX; /* Current position in X of touch device */  
    y = _TouchPositionY; /* Current position in Y of touch device */  
} else {  
    x = y = -1;          /* Use -1 if touch is not pressed */  
}  
GUI_TOUCH_StoreState(x, y);
```

### 6.10.4.1.3 GUI\_TOUCH\_StoreStateEx()

#### Description

Stores the current state of the touch screen.

#### Prototype

```
void GUI_TOUCH_StoreStateEx(const GUI_PID_STATE * pState);
```

#### Parameters

Parameter	Description
<code>pState</code>	Pointer to a structure of type <code>GUI_PID_STATE</code> .

#### Additional information

This function will call `GUI_PID_StoreState()`. A detailed example of a touch handling routine can be found in `Sample\GUI_X\GUI_X_Touch_StoreState.c`.

#### Example

```
GUI_PID_STATE State;
State.x = _TouchPositionX;
State.y = _TouchPositionY;
if (_TouchIsPressed) {
    State.Pressed = 1;
} else {
    State.Pressed = 0;
}
GUI_TOUCH_StoreStateEx(&State);
```



### 6.10.4.2 The analog touch screen driver

The emWin touch-screen driver handles analog input (from an 8-bit or better A/D converter), debouncing and calibration of the touch-screen. The touch-screen driver continuously monitors and updates the touch-panel through the use of the function `GUI_TOUCH_Exec()`, which calls the appropriate generic touchscreen API routines when it recognizes that an action has been performed or something has changed.

#### How an analog touch screen works

The touch panel consists of 2 thin conducting layers of glass, normally insulated from each other. If the user presses the touch panel, the two layers are connected at that point. If a voltage is applied to the Y-layer, when pressed, a voltage can be measured at the X+/X-terminals. This voltage depends on the touch position. The same thing holds true the other way round. If a voltage is applied to the X-layer, when pressed, a voltage can be measured at the Y+/Y-terminals.

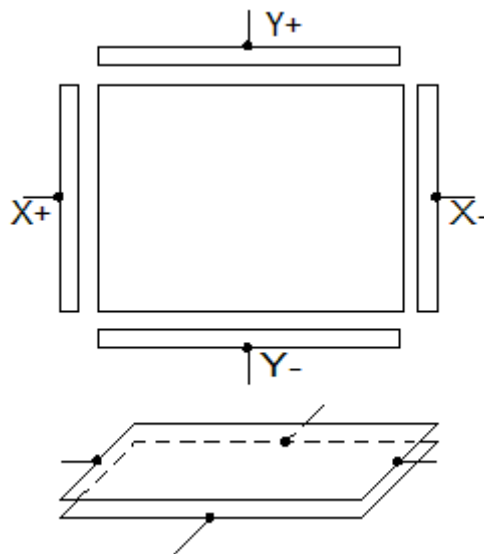

#### 6.10.4.2.1 Setting up the analog touch screen

Putting a touch panel into operation should be done in the following steps:

- Implementing the hardware routines
- Implementing regular calls to `GUI_TOUCH_Exec()`
- Verifying proper operation with the oscilloscope
- Using example to determine calibration values
- Adding a call of `GUI_TOUCH_Calibrate()` to the initialization routine `LCD_X_Config()` using the determined values

The following shows a detailed description of each step.

#### Implementing the hardware routines

The first step of implementing a touch screen should be filling the hardware routines with code. These routines are:

- `GUI_TOUCH_X_ActivateX()` and `GUI_TOUCH_X_ActivateY()`
- `GUI_TOUCH_X_MeasureX()` and `GUI_TOUCH_X_MeasureY()`

A module `GUI_TOUCH_X.c` containing the empty routines is located in the folder `Sample\GUI_X`. You can use this module as a starting point. The activate routines should prepare the measurement by switching on the measurement voltage. `GUI_TOUCH_X_ActivateX()` for example should prepare the measurement in Y by switching on the measurement voltage in X. Further it should switch of the voltage in Y and disable the measurement in X. The measurement routines should return the measurement result of a A/D converter. Later in this chapter you will find an example implementation of the hardware routines.

## Implementing regular calls to GUI\_TOUCH\_Exec()

The second step of implementing a touch screen is to make sure, that the function `GUI_TOUCH_Exec()` will be called in regular intervals. The application should call it about 100 times/second. If a real-time operating system is used, the easiest way to make sure this function is called is to create a separate task. When not using a multitasking system, an interrupt service routine may do the job. The function `GUI_TOUCH_Exec()` measures x- and y-axis in turns. So complete measurements are done once both axes were measured.

## Verifying proper operation with the oscilloscope

After implementing the call of `GUI_TOUCH_Exec()` make sure the hardware works. The easiest way to do this is to measure the supply and measurement voltages of the touch panel with a oscilloscope. The following table shows a typical result. The first column shows the supply voltage of an axis, the second column shows the result of measuring the measurement voltage when pressing in the middle of the touch panel.

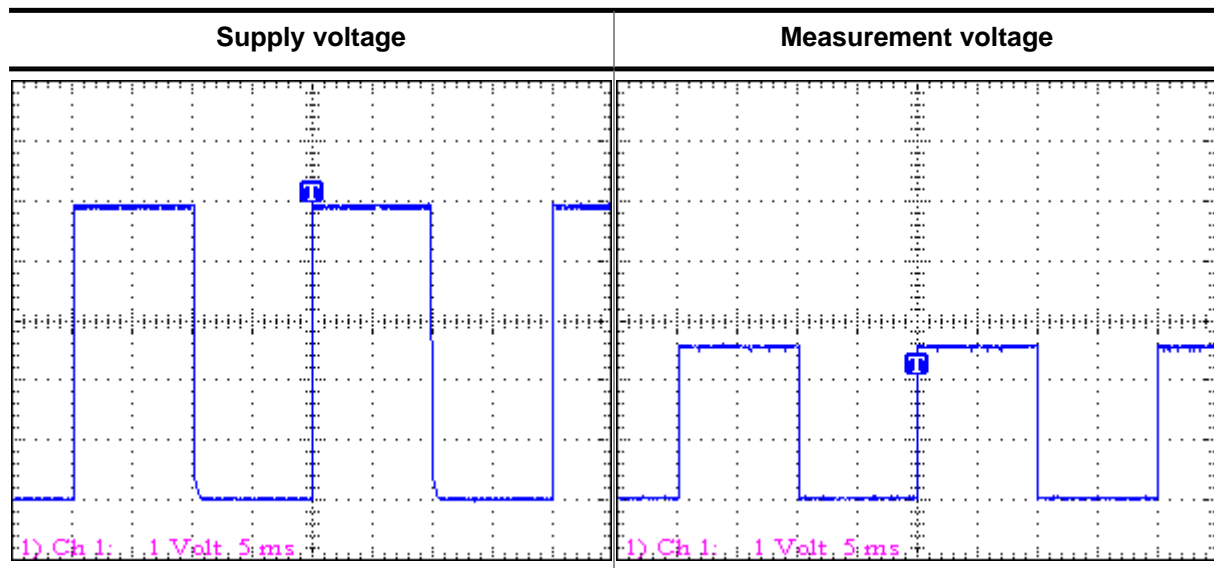

## Use example to determine calibration values

The third step is to get the minimum and maximum values of the A/D converter. emWin needs this values to convert the measurement result to the touch position in pixels. These 4 values are:

Value	How to get them
<code>GUI_TOUCH_AD_TOP</code>	Press the touch at the top and write down the analog input value in Y.
<code>GUI_TOUCH_AD_BOTTOM</code>	Press the touch at the bottom and write down the analog input value in Y.
<code>GUI_TOUCH_AD_LEFT</code>	Press the touch at the left and write down the analog input value in X.
<code>GUI_TOUCH_AD_RIGHT</code>	Press the touch at the right and write down the analog input value in X.

The example folder of emWin contains a small program which can be used to get these values from your touch panel. It is located in the folder `Sample\Tutorial` and its name is `TOUCH_Sample.c`. Run this example on your hardware. The output should be similar to the screenshot at the right side.

```

Measurement of
A/D converter values
Analog input:
x:0423, y:0386
Position:
x:0093, y:0043

```



### Use GUI\_TOUCH\_Calibrate() with the above values

The last step is adding a call to `GUI_TOUCH_Calibrate()` using the calibration values. The recommended location for calibrating the touch screen is the initialization routine `LCD_X_Config()` which is located in `LCDConf.c`. similar to following example:

```

#define GUI_TOUCH_AD_TOP      877
#define GUI_TOUCH_AD_BOTTOM  273
#define GUI_TOUCH_AD_LEFT    232
#define GUI_TOUCH_AD_RIGHT   918
.
.
.
void LCD_X_Config(void) {
    //
    // Initialize display driver
    //
    .
    .
    .
    //
    // Set orientation of touch screen (only required when using
    //
    TouchOrientation = (GUI_MIRROR_X * LCD_GetMirrorX()) |
                       (GUI_MIRROR_Y * LCD_GetMirrorY()) |
                       (GUI_SWAP_XY * LCD_GetSwapXY())    ;
    GUI_TOUCH_SetOrientation(TouchOrientation);
    //
    // Calibrate touch screen
    //
    GUI_TOUCH_Calibrate(GUI_COORD_X, 0, 240, GUI_TOUCH_AD_TOP , GUI_TOUCH_AD_BOTTOM);
    GUI_TOUCH_Calibrate(GUI_COORD_Y, 0, 320, GUI_TOUCH_AD_LEFT, GUI_TOUCH_AD_RIGHT);
}

```

#### 6.10.4.2.2 Runtime calibration

In practice the exact values for the configuration file can be determined only for one touch panel. Because there are small differences between the parts of a series it could be very useful to calibrate each device at run-time. This can be done by using the function `GUI_TOUCH_Calibrate()`. The `Sample` folder contains the example `TOUCH_Calibrate.c` which shows, how a touch screen can be calibrated at run time:

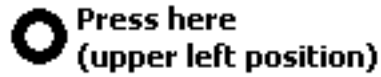

**Runtime calibration,  
please touch the screen  
at the center of the ring.**

### 6.10.4.2.3 Hardware routines

The following four hardware-dependent functions need to be added to your project if you use the driver supplied with emWin, as they are called by `GUI_TOUCH_Exec()` when polling the touch-panel. A suggested place is in the file `GUI_X.c`. These functions are as follows:

Routine	Description
<code>GUI_TOUCH_X_ActivateX()</code>	Prepares measurement for Y-axis.
<code>GUI_TOUCH_X_ActivateY()</code>	Prepares measurement for X-axis.
<code>GUI_TOUCH_X_MeasureX()</code>	Returns the X-result of the A/D converter.
<code>GUI_TOUCH_X_MeasureY()</code>	Returns the Y-result of the A/D converter.

#### 6.10.4.2.3.1 GUI\_TOUCH\_X\_ActivateX()

#### 6.10.4.2.3.2 GUI\_TOUCH\_X\_ActivateY()

##### Description

These routines are called from `GUI_TOUCH_Exec()` to activate the measurement of the X- and the Y-axes. `GUI_TOUCH_X_ActivateX()` switches on the measurement voltage to the X-axis; `GUI_TOUCH_X_ActivateY()` switches on the voltage to the Y- axis. Switching on the voltage in X means the value for the Y-axis can be measured and vice versa.

##### Prototypes

```
void GUI_TOUCH_X_ActivateX(void);
```

```
void GUI_TOUCH_X_ActivateY(void);
```

### 6.10.4.2.3.3 GUI\_TOUCH\_X\_MeasureX()

### 6.10.4.2.3.4 GUI\_TOUCH\_X\_MeasureY()

#### Description

These routines are called from GUI\_TOUCH\_Exec() to return the measurement values from the A/D converter for the X- and the Y-axes.

#### Prototypes

```
int GUI_TOUCH_X_MeasureX(void);
```

```
int GUI_TOUCH_X_MeasureY(void);
```

#### Example implementation

The following shows an example implementation of the touch hardware routines for a Renesas M16C/80 controller:

```
void GUI_TOUCH_X_ActivateX(void) {
    U8 Data;
    asm("fclr i"); /* Disable interrupts */
    Data = P10; /* Read port data */
    Data |= (1 << 2) | (1 << 3); /* Switch on power in X
                                and enable measurement in Y */
    Data &= ~(1 << 4) | (1 << 5); /* Switch off power in Y
                                and disable measurement in X */
    P10 = Data; /* Write port data */
    asm("fset i"); /* Enable interrupts */
}
void GUI_TOUCH_X_ActivateY(void) {
    U8 Data;
    asm("fclr i"); /* Disable interrupts */
    Data = P10; /* Read port data */
    Data |= (1 << 5) | (1 << 4); /* Switch on power in Y
                                and enable measurement in X */
    Data &= ~(1 << 3) | (1 << 2); /* Switch off power in X
                                and disable measurement in Y */
    P10 = Data; /* Write port data */
    asm("fset i"); /* Enable interrupts */
}
static void ReadADCx(int channel) {
    ADCON0 = channel /* Select channel 0-7 */
            | (0 << 3) /* One shot mode */
            | (0 << 6) /* A-D conversion start (0=stop) */
            | (0 << 7); /* FAD/4 select */
    ADCON1 = (0 << 0) /* A-D sweep select (XX) */
            | (0 << 2) /* No sweep mode */
            | (0 << 3) /* 8 bit mode */
            | (0 << 4) /* FAD4 select */
            | (1 << 5) /* VRef connected */
            | (0 << 6); /* Anex0/1 not used */
    ADCON2 = (1 << 0); /* Use example and hold */
    ADIC = 0; /* Reset IR flag */
    ADCON0 |= (1 << 6); /* Start conversion */
    while ((ADIC & (1 << 3)) == 0); /* Wait for end of conversion */
    ADCON0 &= ~(6 << 0); /* Start conversion = 0 */
}
int GUI_TOUCH_X_MeasureX(void) {
    ReadADCx(0);
    return AD0;
}
int GUI_TOUCH_X_MeasureY(void) {
    ReadADCx(1);
    return AD1;
}
```

```
}
```

#### 6.10.4.2.4 Driver API for analog touch screens

The table below lists the available analog touch screen driver routines in alphabetical order. These functions only apply if you are using the driver included with emWin.

<b>Routine</b>	<b>Description</b>
<code>GUI_TOUCH_Calibrate()</code>	Changes the calibration at runtime.
<code>GUI_TOUCH_Exec()</code>	Polls the touch-screen by calling the <code>TOUCH_X</code> routines to activate the measurement of the X- and Y-axes.
<code>GUI_TOUCH_GetxPhys()</code>	Returns a measurement value of the x-coordinate given from the A/D-converter.
<code>GUI_TOUCH_GetyPhys()</code>	Returns a measurement value of the y-coordinate given from the A/D-converter.
<code>GUI_TOUCH_SetOrientation()</code>	The function configures the touch screen orientation.



#### 6.10.4.2.4.1 GUI\_TOUCH\_Calibrate()

##### Description

Changes the calibration at runtime.

##### Prototype

```
int GUI_TOUCH_Calibrate(int Coord,  
                        int Log0,  
                        int Log1,  
                        int Phys0,  
                        int Phys1);
```

##### Parameters

Parameter	Description
<a href="#">Coord</a>	GUI_COORD_X for X-axis, GUI_COORD_Y for Y-axis.
<a href="#">Log0</a>	Logical value 0 in pixels.
<a href="#">Log1</a>	Logical value 1 in pixels.
<a href="#">Phys0</a>	A/D converter value for <a href="#">Log0</a> .
<a href="#">Phys1</a>	A/D converter value for <a href="#">Log1</a> .

##### Additional information

The function takes as parameters the axis to be calibrated, two logical values in pixels for this axis and two corresponding physical values of the A/D converter. Since the logical value [Log0](#) usually is set to 0, [Log1](#) should contain the (x- or y-)size decreased by 1.

#### 6.10.4.2.4.2 GUI\_TOUCH\_Exec()

##### Description

Polls the touch-screen by calling the TOUCH\_X routines to activate the measurement of the X- and Y-axes. It is required that this function is called for about 100 times per second, since there is only one axis measured per call. Therefore a complete measurement of the touch screen is done with 2 calls of GUI\_TOUCH\_Exec().

##### Prototype

```
void GUI_TOUCH_Exec(void);
```

##### Additional information

If you are using a real-time operating system, the easiest way to make sure this function is called is to create a separate task. When not using a multitask system, you can use an interrupt service routine to do the job. This function calls GUI\_TOUCH\_StoreState().

#### 6.10.4.2.4.3 GUI\_TOUCH\_GetxPhys()

#### 6.10.4.2.4.4 GUI\_TOUCH\_GetyPhys()

##### Description

Returns a measurement value of the x- or y-coordinate given from the A/D-converter.

##### Prototype

```
int GUI_TOUCH_GetyPhys(void);
```

##### Return value

Measurement value of the x- or y-coordinate.

##### Additional information

A sample which shows how to use these functions is located in the folder `Sample\Tutorial` with the name `TOUCH_Sample.c`. Run this example on your hardware.

#### 6.10.4.2.4.5 GUI\_TOUCH\_SetOrientation()

##### Description

The function configures the touch screen orientation. If the touch screen for example already has been configured to work with the default orientation and the display now needs to be turned or mirrored, this function can be used to configure the touch driver to use the same orientation as the display without changing anything at the hardware routines.

##### Prototype

```
void GUI_TOUCH_SetOrientation(unsigned Orientation);
```

##### Parameters

Parameter	Description
<a href="#">Orientation</a>	One or more "OR"-combined values of the values to be found under <i>Orientation flags</i> on page 3280.

##### Additional information

Please note that this function has no effect when passing touch in-out to emWin by using the functions `GUI_PID_StoreState()`, `GUI_TOUCH_StoreState()` and `GUI_TOUCH_StoreStateEx()`.

### 6.10.4.2.5 Configuring the analog touch-screen driver

The touch screen driver is completely run-time configurable.

GUI\_TOUCH\_Calibrate() should be used to specify the physical values returned by the A/D converter for 2 positions per axis. If the display needs to be turned or mirrored, GUI\_TOUCH\_SetOrientation() can be used to set a new orientation without changing anything at the hardware routines.

Configuring the touch screen should be done before emWin manages any touch input.

#### Example

```
#define TOUCH_AD_LEFT 0x3c0
#define TOUCH_AD_RIGHT 0x034
#define TOUCH_AD_TOP 0x3b0
#define TOUCH_AD_BOTTOM 0x034
Orientation = (GUI_MIRROR_X * LCD_GetMirrorXEx(0)) |
              (GUI_MIRROR_Y * LCD_GetMirrorYEx(0)) |
              (GUI_SWAP_XY * LCD_GetSwapXYEx (0)) ;
GUI_TOUCH_SetOrientation(Orientation);
GUI_TOUCH_Calibrate(GUI_COORD_X, 0, 319, TOUCH_AD_LEFT, TOUCH_AD_RIGHT);
GUI_TOUCH_Calibrate(GUI_COORD_Y, 0, 239, TOUCH_AD_TOP, TOUCH_AD_BOTTOM);
```

### 6.10.5 Touch screen calibration

Normally a touch screen is mounted over the display. That means the data measured by the touch screen need to be translated into pixel coordinates of the display. To be able to do that transformation, the calibration algorithm needs to calculate transformation coefficients first. That can be done with a different number of points. The more points are available for coefficient calculation, the better the result. If rotation should be considered, at least 3 points are required for coefficient calculation.

#### 2-Point Calibration

The classical calibration algorithm of emWin uses 2-point calibration. That means the calibration is done by passing 2 reference points (pixel coordinates) and 2 sample values (measurement results) for each axis to the calibration routine. Normally those points are near to the min- and max-values of each axis. The resulting calibration coefficients of a 2-point-calibration do not consider rotation. Only scaling and transformation could be considered. The following diagram shows the recommended position of the points to be used:

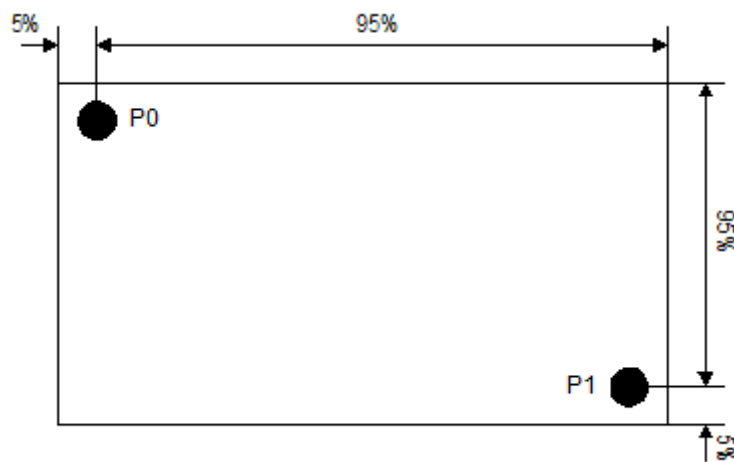

#### 3-Point Calibration

A third calibration point makes it possible to consider scaling, transformation and rotation between reference- and sample values. The following diagram shows the recommended position of the points to be used:

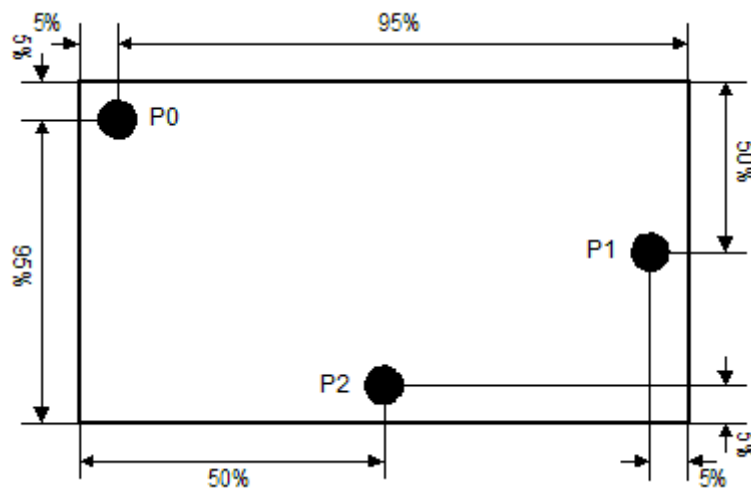

#### N-Point Calibration

The more points are available, the better is the result of coefficient calculation. The following diagrams show the recommended positions for a 5- and a 9-point calibration:

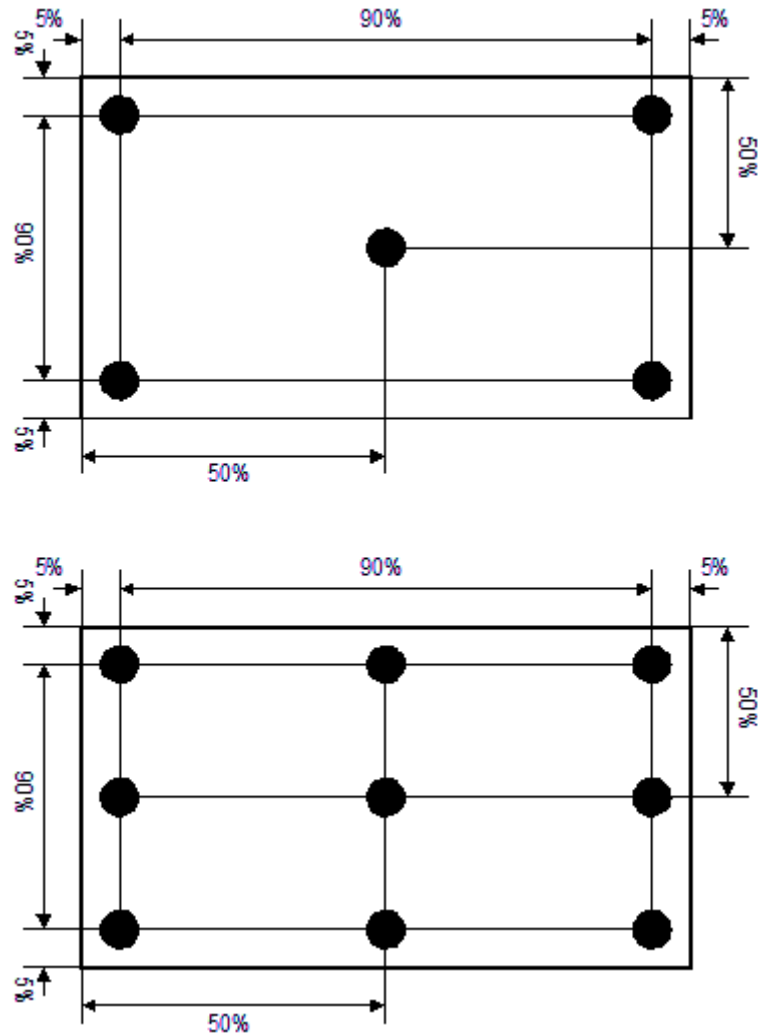

### 6.10.5.1 Using calibration with the analog touch screen driver

The analog touch screen driver shipped with emWin automatically uses the touch screen calibration routines. To be able to use it the calibration has to be initialized by calculating the calibration coefficients. That could be done by calling `GUI_TOUCH_Calibrate()` explained in chapter *The analog touch screen driver* on page 833 for a 2-point calibration. If 3 or more points should be used the function `GUI_TOUCH_CalcCoefficients()` should be called.

### 6.10.5.2 Using calibration with a custom touch screen driver

If there is an already existing a touch screen driver available and the internal analog touch screen driver of emWin is not used, the way of using the calibration routines is different. The most simple way is calling `GUI_TOUCH_CalcCoefficients()` for coefficient calculation. The second step is calling `GUI_TOUCH_EnableCalibration()`. That makes sure, that all touch events will be calibrated automatically before they are stored into the PID-buffer of emWin. It is also possible to use the calibration API functions by the application before an event is stored into the PID buffer.

### 6.10.5.3 Calibration API

The table below lists the available calibration routines in alphabetical order.

Routine	Description
<code>GUI_TOUCH_CalcCoefficients()</code>	This routine is required for initializing the process of calibration.
<code>GUI_TOUCH_CalibratePoint()</code>	The function converts the given sample point into screen coordinates in pixels and checks if the given values are within the display area.
<code>GUI_TOUCH_EnableCalibration()</code>	This function may be used if the calibration routines should be used with a custom touch screen driver.
<code>GUI_TOUCH_TransformPoint()</code>	Calibrates the given point without any check.



### 6.10.5.3.1 GUI\_TOUCH\_CalcCoefficients()

#### Description

This routine is required for initializing the process of calibration. To be able to calibrate a point via `GUI_TOUCH_CalibratePoint()` or `GUI_TOUCH_TransformPoint()` coefficient values are required for transforming the given values into pixel coordinates. These coefficients are calculated by the given reference values and the according sample values passed to this routine. As explained at the beginning of this subchapter coefficient calculation can be done with at least 2 points. To achieve the best possible result it is recommended to use 3 or more points.

#### Prototype

```
int GUI_TOUCH_CalcCoefficients(int    NumPoints,
                              int *  pxRef,
                              int *  pyRef,
                              int *  pxSample,
                              int *  pySample,
                              int    xSize,
                              int    ySize);
```

#### Parameters

Parameter	Description
<code>NumPoints</code>	Number of points used for calculating the calibration coefficients.
<code>pxRef</code>	Pointer to an array of reference values for X-axis.
<code>pyRef</code>	Pointer to an array of reference values for Y-axis.
<code>pxSample</code>	Pointer to an array of sample values for X-axis.
<code>pySample</code>	Pointer to an array of sample values for Y-axis.
<code>xSize</code>	X-size in pixels of the touch screen.
<code>ySize</code>	Y-size in pixels of the touch screen.

#### Return value

0        on success.  
1        on error.

### 6.10.5.3.2 GUI\_TOUCH\_CalibratePoint()

#### Description

The function converts the given sample point into screen coordinates in pixels and checks if the given values are within the display area. If not an error is returned.

#### Prototype

```
int GUI_TOUCH_CalibratePoint(int * px,  
                             int * py);
```

#### Parameters

Parameter	Description
<code>px</code>	Pointer to a sample coordinate of the X-axis.
<code>py</code>	Pointer to a sample coordinate of the Y-axis.

#### Return value

0        on success  
1        on error.

#### Additional information

Coefficients need to be calculated first.

### 6.10.5.3.3 GUI\_TOUCH\_EnableCalibration()

#### Description

This function may be used if the calibration routines should be used with a custom touch screen driver. When using a custom touch screen driver normally `GUI_TOUCH_StoreState()` or `GUI_TOUCH_StoreStateEx()` is used for putting touch events into the PID-buffer of emWin. The default behavior of emWin is storing the coordinates into the buffer without calibration. If enabled each coordinate will be calibrated before it is stored into the buffer.

#### Prototype

```
void GUI_TOUCH_EnableCalibration(int OnOff);
```

#### Parameters

Parameter	Description
<code>OnOff</code>	1 for enabling calibration, 0 for disabling (default).

#### Additional information

When using the analog touch screen driver of emWin this function is not required.

### 6.10.5.3.4 GUI\_TOUCH\_TransformPoint()

#### Description

Calibrates the given point without any check.

#### Prototype

```
int GUI_TOUCH_TransformPoint(int * px,  
                             int * py);
```

#### Parameters

Parameter	Description
<code>px</code>	Pointer to a sample coordinate of the X-axis.
<code>py</code>	Pointer to a sample coordinate of the Y-axis.

#### Return value

0        on success  
1        on error.

#### Additional information

Coefficients need to be calculated first.

## 6.10.6 Joystick input example

The following example shows how the pointer input device API can be used to process the input from a joystick:

```

/*****
 *
 *      _JoystickTask
 *
 * Purpose:
 * Periodically read the Joystick and inform emWin using
 * GUI_PID_StoreState.
 * It supports dynamic acceleration of the pointer.
 * The Joystick is a simple, standard 5 switch (digital) type.
 *
 */
static void _JoystickTask(void) {
    GUI_PID_STATE State;
    int Stat;
    int StatPrev = 0;
    int TimeAcc = 0;    // Dynamic acceleration value
    int xMax, yMax;

    xMax = LCD_GetXSize() - 1;
    yMax = LCD_GetYSize() - 1;
    while (1) {
        Stat = HW_ReadJoystick();
        //
        // Handle dynamic pointer acceleration
        //
        if (Stat == StatPrev) {
            if (TimeAcc < 10) {
                TimeAcc++;
            }
        } else {
            TimeAcc = 1;
        }
        if (Stat || (Stat != StatPrev)) {
            //
            // Compute the new coordinates
            //
            GUI_PID_GetState(&State);
            if (Stat & JOYSTICK_LEFT) {
                State.x -= TimeAcc;
            }
            if (Stat & JOYSTICK_RIGHT) {
                State.x += TimeAcc;
            }
            if (Stat & JOYSTICK_UP) {
                State.y -= TimeAcc;
            }
            if (Stat & JOYSTICK_DOWN) {
                State.y += TimeAcc;
            }
            //
            // Make sure coordinates are still in bounds
            //
            if (State.x < 0) {
                State.x = 0;
            }
            if (State.y < 0) {
                State.y = 0;
            }
            if (State.x >= xMax) {
                State.x = xMax;
            }
            if (State.y > yMax) {

```

```
    State.y = yMax;
  }
  //
  // Inform emWin
  //
  State.Pressed = (Stat & JOYSTICK_ENTER) ? 1: 0;
  GUI_PID_StoreState(&State);
  StatPrev = Stat;
}
OS_Delay(40);
}
```

## 6.11 Info about screen changes

Under certain circumstances, it may be necessary or useful to get information about the display areas that have changed since the last display refresh. There are basically two different modules that can be used, the DIRTYDEVICE and the DIRTYTILES object.

### GUI\_DIRTYTILES

When using multiple buffering to suppress flickering effects, it can be useful to use GUI\_DIRTYTILES. When the DIRTYTILES object is created, it divides the screen into multiple rows and columns. The number of rows and columns must be specified when the object is created. While the DIRTYDEVICE object calculates one single 'dirty' rectangle, the DIRTYTILES object calculates dirty tiles. The higher the resolution of a display, the more useful the DIRTYTILES object can be. For example, if only some pixels at the upper left and lower right corner of the display have changed since the last display refresh, it is not necessary to copy the entire content from the front buffer to the back buffer when starting the drawing operation with GUI\_MULTIBUF\_Begin(). Only the contents of the dirty tiles need to be copied from the frontbuffer to the backbuffer.

### GUI\_DIRTYDEVICE

This module measures exactly which area of the screen has been changed since the last display refresh. The calculated area is one simple rectangle.

### 6.11.1 API

The table below lists the available graphic-related routines in alphabetical order within their respective categories. Detailed descriptions can be found in the sections that follow.

#### Functions

Routine	Description
DIRTYDEVICE	
<a href="#">GUI_DIRTYDEVICE_Create()</a>	Creates a DIRTYDEVICE object.
<a href="#">GUI_DIRTYDEVICE_CreateEx()</a>	Creates a DIRTYDEVICE object in the given layer.
<a href="#">GUI_DIRTYDEVICE_Delete()</a>	Deletes a DIRTYDEVICE object.
<a href="#">GUI_DIRTYDEVICE_DeleteEx()</a>	Deletes a DIRTYDEVICE object from the given layer.
<a href="#">GUI_DIRTYDEVICE_Fetch()</a>	Fetches information from a DIRTYDEVICE.
<a href="#">GUI_DIRTYDEVICE_FetchEx()</a>	Fetches information from a DIRTYDEVICE of the given layer.
DIRTYTILES	
<a href="#">GUI_DIRTYTILES_CleanUp()</a>	Clears the dirty state from a DIRTYTILES object.
<a href="#">GUI_DIRTYTILES_CleanUpEx()</a>	Clears the dirty state from a DIRTYTILES object of the given layer.
<a href="#">GUI_DIRTYTILES_Create()</a>	Creates a DIRTYTILES object.
<a href="#">GUI_DIRTYTILES_CreateEx()</a>	Creates a DIRTYTILES object in the given layer.
<a href="#">GUI_DIRTYTILES_Fetch()</a>	Fetches information from a DIRTYTILES object.
<a href="#">GUI_DIRTYTILES_FetchEx()</a>	Fetches information from a DIRTYTILES object of the given layer.

## 6.11.1.1 DIRTYDEVICE

### 6.11.1.1.1 GUI\_DIRTYDEVICE\_Create()

#### Description

A DIRTYDEVICE is an object which makes it possible to monitor the changed area of the screen. In combination with `GUI_DIRTYDEVICE_Fetch()` it makes it possible, to check if the content of the screen has been changed. If changes have been detected the function `GUI_DIRTYDEVICE_Fetch()` returns 1 and fills up an information structure with size and position of the changed area. If nothing has been changed `GUI_DIRTYDEVICE_Fetch()` returns 0.

In case of working with multiple layers the function does not monitor all layers simultaneously. For each layer a separate DIRTYDEVICE needs to be created (if monitoring is required).

Calling `GUI_DIRTYDEVICE_Create()` creates such an monitoring object in the currently selected layer which then automatically monitors all screen drawing operations. If no longer used it can be deleted with `GUI_DIRTYDEVICE_Delete()`.

#### Prototype

```
int GUI_DIRTYDEVICE_Create(void);
```

#### Return value

0	on success
1	on error.

#### Additional information

A DIRTYDEVICE is also able to return advanced information like a pointer to the first changed pixel, the number of bytes used per pixel and the stride value in pixels from one line of data to the next line. To be able to use those features, a linear addressable driver is required. Further, the DIRTYDEVICE needs to be created in `LCD_X_Config()` immediately after the driver of the layer was created.



### 6.11.1.1.2 GUI\_DIRTYDEVICE\_CreateEx()

#### Description

Creates a DIRTYDEVICE in the given layer. For details please refer to the function `GUI_DIRTYDEVICE_Create()`.

#### Prototype

```
int GUI_DIRTYDEVICE_CreateEx(int LayerIndex);
```

#### Parameters

Parameter	Description
<code>LayerIndex</code>	<code>LayerIndex</code> to be used.

#### Return value

0        on success  
1        on error.

### 6.11.1.1.3 GUI\_DIRTYDEVICE\_Delete()

#### Description

Removes the DIRTYDEVICE of the currently selected layer. If not possible the function returns an error.

#### Prototype

```
int GUI_DIRTYDEVICE_Delete(void);
```

#### Return value

0	on success
1	on error.

#### 6.11.1.1.4 GUI\_DIRTYDEVICE\_DeleteEx()

##### Description

Removes the DIRTYDEVICE of the given layer. If not possible the function returns an error.

##### Prototype

```
int GUI_DIRTYDEVICE_DeleteEx(int LayerIndex);
```

##### Parameters

Parameter	Description
LayerIndex	LayerIndex to be used.

##### Return value

0        on success  
1        on error.

### 6.11.1.1.5 GUI\_DIRTYDEVICE\_Fetch()

#### Description

The function fills the given structure with the coordinates and the size of the changed screenarea of the current layer. If no changes have been detected since the last call the function returns 0.

#### Prototype

```
int GUI_DIRTYDEVICE_Fetch(GUI_DIRTYDEVICE_INFO * pInfo);
```

#### Parameters

Parameter	Description
<code>pInfo</code>	Pointer to the GUI_DIRTYDEVICE_INFO-structure which is filled with size and coordinates of the changed area.

#### Return value

- 0 if no changes have been detected
- 1 if changes are detected.

### 6.11.1.1.6 GUI\_DIRTYDEVICE\_FetchEx()

#### Description

The function fills the given structure with the coordinates and the size of the changed screenarea of the given layer.

#### Prototype

```
int GUI_DIRTYDEVICE_FetchEx(GUI_DIRTYDEVICE_INFO * pInfo,  
                           int LayerIndex);
```

#### Parameters

Parameter	Description
<code>pInfo</code>	Pointer to the <code>GUI_DIRTYDEVICE_INFO</code> -structure which is filled with size and coordinates of the changed area.
<code>LayerIndex</code>	Layer index to be used.

#### Elements of structure GUI\_DIRTYDEVICE\_INFO

Refer to *GUI\_DIRTYDEVICE\_Fetch* on page 860 for the elements of the structure `GUI_DIRTYDEVICE_INFO`.

#### Return value

- 0 if no changes have been detected
- 1 if changes are detected.

## 6.11.1.2 DIRTYTILES

### 6.11.1.2.1 GUI\_DIRTYTILES\_CleanUp()

#### Description

This function clears the dirty states of the current layer. After the dirty states have been processed following the copy operation, it is necessary to clear the bytes.

#### Prototype

```
void GUI_DIRTYTILES_CleanUp(void);
```

#### Parameters

Parameter	Description
<a href="#">LayerIndex</a>	<a href="#">LayerIndex</a> to be used.

### 6.11.1.2.2 GUI\_DIRTYTILES\_CleanUpEx()

#### Description

This function deletes the dirty states of the given layer. After the dirty states have been processed following the copy operation, it is necessary to clear the bytes.

#### Prototype

```
void GUI_DIRTYTILES_CleanUpEx(int LayerIndex);
```

#### Parameters

Parameter	Description
LayerIndex	LayerIndex to be used.

### 6.11.1.2.3 GUI\_DIRTYTILES\_Create()

#### Description

Creates a DIRTYTILES object on the current layer. See the GUI\_DIRTYTILES\_CreateEx() function for details.

#### Prototype

```
int GUI_DIRTYTILES_Create(int NumCols,  
                          int NumRows);
```

#### Parameters

Parameter	Description
NumCols	Number of columns to be used.
NumRows	Number of rows to be used.

#### Return value

0        on success  
1        on error.



### 6.11.1.2.4 GUI\_DIRTYTILES\_CreateEx()

#### Description

The DIRTYTILES object divides the screen into the specified number of rows and columns. It then checks which tiles have been touched by drawing operations. If multiple buffers are used, only the 'dirty' tiles need to be copied from the front buffer to the back buffer when drawing operations are started. The higher the display resolution, the higher the performance gain.

#### Prototype

```
int GUI_DIRTYTILES_CreateEx(int NumCols,  
                           int NumRows,  
                           int LayerIndex);
```

#### Parameters

Parameter	Description
<a href="#">NumCols</a>	Number of columns to be used.
<a href="#">NumRows</a>	Number of rows to be used.
<a href="#">LayerIndex</a>	<a href="#">LayerIndex</a> to be used.

#### Return value

0        on success  
1        on error.

### 6.11.1.2.5 GUI\_DIRTYTILES\_Fetch()

#### Description

The function returns a list of rectangles and a list of dirty indicators of the current layer. For details please refer to the function `GUI_DIRTYTILES_FetchEx()`.

#### Prototype

```
int GUI_DIRTYTILES_Fetch(GUI_RECT ** ppRects,  
                        U8      ** ppBytes);
```

#### Parameters

Parameter	Description
<code>ppRects</code>	Points to a pointer for the tiles.
<code>ppBytes</code>	Points to a pointer for the 'dirty' indicators.

#### Return value

Total number of tiles.

### 6.11.1.2.6 GUI\_DIRTYTILES\_FetchEx()

#### Description

The function returns a list of rectangles and a list of dirty indicators. After calling the function, the rectangle pointer points to a list of rectangles and the byte pointer points to a list of bytes indicating the dirty state of a tile. Each byte indicates whether a rectangle has been touched by a drawing operation or not. If a rectangle was touched, the dirty state is 1, otherwise it is 0. To perform the required copy operation from the front to the back buffer, simply iterate over the list of rectangles and the list of indicator bytes simultaneously. If a byte is 'dirty', the rectangle must be copied from the front buffer to the back buffer.

#### Prototype

```
int GUI_DIRTYTILES_FetchEx(GUI_RECT ** ppRects,  
                           U8      ** ppBytes,  
                           int       LayerIndex);
```

#### Parameters

Parameter	Description
<a href="#">ppRects</a>	Points to a pointer for the tiles.
<a href="#">ppBytes</a>	Points to a pointer for the 'dirty' indicators.
<a href="#">LayerIndex</a>	<a href="#">LayerIndex</a> to be used.

#### Return value

Total number of tiles.

## 6.11.2 Data structures

### 6.11.2.1 GUI\_DIRTYDEVICE\_INFO

#### Description

Information about the dirty device.

#### Type definition

```
typedef struct {
    void * pData;
    int    x0;
    int    y0;
    int    xSize;
    int    ySize;
    int    LineOff;
    int    BytesPerPixel;
    int    IsDirty;
} GUI_DIRTYDEVICE_INFO;
```

#### Structure members

Member	Description
<code>pData</code>	Pointer to the first changed pixel.*1
<code>x0</code>	Leftmost position of changed area.
<code>y0</code>	Topmost position of changed area.
<code>xSize</code>	Size in X of changed area.
<code>ySize</code>	Size in Y of changed area.
<code>LineOff</code>	Number of pixels (stride) from one line to the next line.*1
<code>BytesPerPixel</code>	Number of bytes required per pixel.
<code>IsDirty</code>	Indicates if dirty pixels exist.

#### See also

- `GUI_DIRTYDEVICE_Fetch()`

#### Note

\*1 Only available if the DIRTYDEVICE is created before the driver has been created.

## 6.12 Multiple Buffering

Multiple Buffering is a method of using more than one frame buffer. Basically it works as follows: With multiple buffers enabled there is a front buffer which is used by the display controller to generate the picture on the screen and one or more back buffers which are used for the drawing operations. After completing the drawing operations the back buffer becomes the visible front buffer.

With two buffers, one front and one back buffer, it is normally called "double buffering", with two back buffers and one front buffer it is called "triple buffering".

In general it is a method which is able to avoid several unwanted effects:

- The visible process of drawing a screen item by item
- Flickering effects caused by overlapping drawing operations
- Tearing effects caused by writing operations outside the vertical blanking period

The following section explains in detail how it works, the requirements to be able to use this feature, how to configure emWin and the advantage of "triple buffering" against "double buffering". Further it explains how to configure the optional Window Manager for automatic use of Multiple Buffering.

### 6.12.1 How it works

Multiple Buffering is the use of more than one frame buffer, so that the display ever shows a screen which is already completely rendered, even if a drawing operation is in process. When starting the process of drawing the current content of the front buffer is copied into a back buffer. After that all drawing operations take effect only on this back buffer. After the drawing operation has been completed the back buffer becomes the front buffer. Making the back buffer the visible front buffer normally only requires the modification of the frame buffer start address register of the display controller.

Now it should be considered that a display is being refreshed continuously by the display controller approximately 60 times per second. After each period there is a vertical synchronization signal, normally known as VSYNC signal. The best moment to make the back buffer the new front buffer is this signal. If not considering the VSYNC signal tearing effects can occur.

#### Tearing effect



### 6.12.1.1 Double Buffering

With double buffering only 2 buffers are available: One front and one back buffer. When starting the drawing operation the current content of the front buffer is copied into the back buffer. After completing the operation the back buffer should become the visible front buffer.

As explained above the best moment for doing this is reacting on the VSYNC signal of the display controller. Here the disadvantage of double buffering against triple buffering is revealed: Either the frame buffer start address is changed immediately at the end of the drawing operation or after waiting until the next VSYNC signal. This means that either tearing effects could occur or the performance slows down because of waiting for the next VSYNC signal.

### 6.12.1.2 Triple Buffering

As the name implies there are 3 buffers available: One front and 2 back buffers. When starting the drawing operation the current content of the front buffer is copied into the first back buffer. After completing the operation the back buffer should become the visible front buffer. Contrary to the double buffer solution it is not required to switch to the buffer immediately. Switching to the new front buffer could be done on the next VSYNC signal of the display controller which can be achieved by an interrupt service routine (ISR). Most of the display controllers which are able to deal with more than one frame buffer provide the VSYNC signal as interrupt source. Within the ISR the pending front buffer should become visible. Until the pending front buffer becomes visible it is not used for further drawing operations. If a further drawing operation is initiated before the pending front buffer has become visible the second back buffer is used for the drawing operation. If a new buffer is ready until waiting for the VSYNC signal it becomes the new pending front buffer and so on. This always protects the front buffer against writing operations.

It should be mentioned that changing the display buffer start address on some display controllers only takes effect when drawing the next frame. In this case the solution without ISR works as well as with ISR. Only if changing the address takes effect directly an ISR is required to avoid tearing effects.

## 6.12.2 Optimizing CPU load

By default, the entire front buffer must be copied to the back buffer before drawing operations begin. The larger the display resolution, the larger the memory area of a frame buffer and the more CPU load is required to copy the buffer. To reduce the CPU load at this point, the DIRTYTILES object can be used. It divides the screen into a configurable number of tiles. During drawing operations, emWin marks all tiles touched by a drawing operation as dirty. When copying from the front to the back buffer, only the areas of the dirty tiles need to be copied. The higher the screen resolution, the greater the performance gain. For details on how to achieve this, see *Info about screen changes* on page 855.

## 6.12.3 Requirements

The following list shows the requirements for using multiple buffers:

- The display controller should support multiple frame buffers.
- Enough video RAM for multiple frame buffers should be available.
- If tearing effects should be avoided it should be possible to react on the VSYNC signal of the display controller and triple buffering is recommended to achieve the best performance.

## 6.12.4 Limitations

Multiple Buffering can not be used with virtual screens.

## 6.12.5 Configuration

In general there are 2 routines in the configuration file `LCDCConf.c` which need to be modified, the display configuration routine `LCD_X_Config()` and the driver callback function `LCD_X_DisplayDriver()`.

### 6.12.5.1 LCD\_X\_Config()

Basically one thing needs to be done here: Enabling the use of multiple buffers.

#### Basic configuration

The first thing which has to be done before creating the display driver device is configuring the multiple buffer interface. This is normally done in `LCD_X_Config()`. It is strictly required to enable Multiple Buffering before creating the display driver device as shown in the following code snippet:

```
void LCD_X_Config(void) {
    //
    // Initialize MultiBuffering
    //
    GUI_MULTIBUF_Config(NUM_BUFFERS);
    //
    // Set display driver and color conversion
    //
    GUI_DEVICE_CreateAndLink(DISPLAY_DRIVER, COLOR_CONVERSION, 0, 0);
    ...
}
```

#### Callback routine for copying the buffers

Further a callback routine for copying the buffers can be set. As explained above at the beginning of the drawing operation it is required to copy the content of the current front buffer to the back buffer. Normally a simple `memcpy` operation is used to do this. But if the used display controller for example consists of a BitBLT-engine which is able to do the copy operation it could be desired to use it for the copy operation. Or a DMA based routine should be used to do the copy operation. In these cases a custom defined callback function can be used for this operation. It can be installed after creating the display driver device as shown in the following code snippet:

```
static void _CopyBuffer(int LayerIndex, int IndexSrc, int IndexDst) {
    unsigned long BufferSize, AddrSrc, AddrDst;

    //
    // Calculate the size of one frame buffer
    //
    BufferSize = (XSIZE * YSIZE * BITSPPERPIXEL) / 8;
    //
    // Calculate source- and destination address
    //
    AddrSrc = _VRamBaseAddr + BufferSize * IndexSrc;
    AddrDst = _VRamBaseAddr + BufferSize * IndexDst;
    memcpy((void *)AddrDst, (void *)AddrSrc, BufferSize);
}

void LCD_X_Config(void) {
    //
    // Initialize multibuffering
    //
    GUI_MULTIBUF_Config(NUM_BUFFERS);
    //
    // Set display driver and color conversion
    //
    GUI_DEVICE_CreateAndLink(DISPLAY_DRIVER, COLOR_CONVERSION, 0, 0);
    //
}
```

```
// Set custom callback function for copy operation
//
LCD_SetDevFunc(0, LCD_DEVFUNC_COPYBUFFER, (void (*)())_CopyBuffer);
}
```

The above sample implementation makes no sense, because the simple call of `memcpy()` equals the default behavior of the display driver. It makes only sense to use a custom copy buffer function if there is any possibility to accelerate the copy operation.

### Callback routine for copying dirty tiles

As explained in the sub chapter above, the CPU load for copying the buffers can be reduced by using the Dirty Tiles object. In this case, a slightly different buffer copy routine should be used, as in the following example:

```
static void _CopyBuffer(int IndexSrc, int IndexDst) {
    GUI_RECT * pRects;
    unsigned char * pBytes;
    int NumTiles, xSize, ySize, y;
    unsigned long Off, AddrSrc, AddrDst, NumBytes, Stride;

    NumTiles = GUI_DIRTYTILES_FetchEx(&pRects, &pBytes, LayerIndex);
    Stride = (XSIZE * BITSPERPIXEL) / 8;
    while (NumTiles--) {
        //
        // Check if tile is dirty
        //
        if (*pBytes) {
            Off = ((pRects->y0 * XSIZE + pRects->x0) * BITSPERPIXEL) / 8;
            AddrSrc = _aBufferAddress[IndexSrc] + Off;
            AddrDst = _aBufferAddress[IndexDst] + Off;
            xSize = pRects->x1 - pRects->x0 + 1;
            ySize = pRects->y1 - pRects->y0 + 1;
            NumBytes = (xSize * BITSPERPIXEL) / 8;
            while (ySize--) {
                memcpy((void *)AddrDst, (void *)AddrSrc, NumBytes);
                AddrSrc += Stride;
                AddrDst += Stride;
            }
        }
        //
        // Increment pointers
        //
        pBytes++;
        pRects++;
    }
    GUI_DIRTYTILES_CleanUpEx(LayerIndex);
}
```

### Buffers in non-consecutive RAM areas

If the RAM on a device is not large enough to hold all buffers used for multiple buffering consecutively, it is possible to pass multiple RAM addresses to `emWin`. By calling `LCD_SetBufferPtr()` it is possible to tell `emWin` the addresses of every single buffer location.

```
static const U32 _aBufferPTR[] = {
    0x00000100, // Begin of On-Chip RAM
    0x00800000 // Begin of Expansion RAM
};
LCD_SetBufferPtrEx(0, (void **)_aBufferPTR);
```

#### 6.12.5.2 LCD\_X\_DisplayDriver()

After the drawing process has been completed the back buffer should become visible. The display driver sends a `LCD_X_SHOWBUFFER` command to the display driver callback function.



The callback function then has to react on the command and should make sure that the buffer becomes visible. This can be done either by an ISR or by directly writing the right address into the frame buffer start address of the display controller.

### With ISR

The following code snippet shows a sample implementation:

```
static void _ISR_EndOfFrame(void) {
    unsigned long Addr, BufferSize;
    if (_PendingBuffer >= 0) {
        //
        // Calculate address of the given buffer
        //
        BufferSize = (XSIZE * YSIZE * BITSPERPIXEL) / 8;
        Addr      = _VRamBaseAddr + BufferSize * _PendingBuffer;
        //
        // Tell LCD controller the new frame buffer address
        //
        AT91C_LCDC_BA1 = Addr;
        //
        // Send a confirmation that the buffer is visible now
        //
        GUI_MULTIBUF_Confirm(_PendingBuffer);
        _PendingBuffer = -1;
    }
}

int LCD_X_DisplayDriver(unsigned LayerIndex, unsigned Cmd, void * p) {
    LCD_X_SHOWBUFFER_INFO * pData;
    switch (Cmd) {
        ...
        case LCD_X_SHOWBUFFER:
            pData = (LCD_X_SHOWBUFFER_INFO *)p;
            //
            // Remember buffer index to be used by ISR
            //
            _PendingBuffer = pData->Index;
            break;
    }
}
```

The above implementation assumes the existence of an ISR which is executed at the next VSYNC signal.

### Without ISR

If there is no ISR available alternatively the address can be set directly with the disadvantage that tearing effects could occur.

The following code snippet shows a sample implementation:

```
int LCD_X_DisplayDriver(unsigned LayerIndex, unsigned Cmd, void * p) {
    LCD_X_SHOWBUFFER_INFO * pData;
    unsigned long      BufferSize;
    unsigned long      Addr;
    switch (Cmd) {
        ...
        case LCD_X_SHOWBUFFER: {
            pData = (LCD_X_SHOWBUFFER_INFO *)p;
            //
            // Calculate address of the given buffer
            //
            BufferSize = (XSIZE * YSIZE * BITSPERPIXEL) / 8;
            Addr      = _VRamBaseAddr + BufferSize * pData->Index;
            //
            // Make the given buffer visible
            //
            AT91C_LCDC_BA1 = Addr;
        }
    }
}
```

```
//  
// Send a confirmation that the buffer is visible now  
//  
GUI_MULTIBUF_Confirm(pData->Index);  
break;  
}  
}
```

## 6.12.6 Automatic use of multiple buffers with the WM

The optional Window Manager (WM) is able to use the multiple buffer feature automatically. The function `WM_MULTIBUF_Enable()` can be used to enable this function. If enabled the WM first switches to the back buffer before redrawing the invalid windows. After drawing all invalid windows the new screen becomes visible. This hides the process of drawing a screen window by window.

## 6.12.7 Multiple Buffering API

The following table lists the available routines of the multiple buffer support.

Routine	Description
<code>GUI_MULTIBUF_Begin()</code>	Needs to be called immediately before the drawing process.
<code>GUI_MULTIBUF_BeginEx()</code>	Needs to be called immediately before the drawing process in the given layer.
<code>GUI_MULTIBUF_Config()</code>	The function needs to be called during initialization in order to enable the use of Multiple Buffering.
<code>GUI_MULTIBUF_ConfigEx()</code>	The function needs to be called during initialization in order to enable the use of Multiple Buffering for the given layer.
<code>GUI_MULTIBUF_Confirm()</code>	This function needs to be called immediately after a new buffer has become visible.
<code>GUI_MULTIBUF_ConfirmEx()</code>	This function needs to be called immediately after a new buffer has become visible in the given layer.
<code>GUI_MULTIBUF_End()</code>	This function needs to be called after the new screen has been completely drawn.
<code>GUI_MULTIBUF_EndEx()</code>	This function needs to be called after the new screen has been completely drawn for the given layer.
<code>GUI_MULTIBUF_GetNumBuffers()</code>	The function returns the number of buffers configured.
<code>GUI_MULTIBUF_GetNumBuffersEx()</code>	The function returns the number of buffers configured for the given layer.
<code>GUI_MULTIBUF_UseSingleBuffer()</code>	Lets the multi buffering use one frame for all layers.

### 6.12.7.1 GUI\_MULTIBUF\_Begin()

#### Description

Needs to be called immediately before the drawing process.

#### Prototype

```
void GUI_MULTIBUF_Begin(void);
```

#### Additional information

This function makes sure that the current front buffer will be copied into the back buffer which then is used for all subsequent drawing operations. The copy operation is normally done by the display driver itself. As explained earlier this can also be achieved by a custom callback function.

## 6.12.7.2 GUI\_MULTIBUF\_BeginEx()

### Description

Needs to be called immediately before the drawing process in the given layer.

### Prototype

```
void GUI_MULTIBUF_BeginEx(int LayerIndex);
```

### Parameters

Parameter	Description
LayerIndex	Layer to be used.

### 6.12.7.3 GUI\_MULTIBUF\_Config()

#### Description

The function needs to be called during initialization in order to enable the use of Multiple Buffering. This is done typically from within `LCD_X_Config()`.

#### Prototype

```
void GUI_MULTIBUF_Config(int NumBuffers);
```

#### Parameters

Parameter	Description
<code>NumBuffers</code>	Number of buffers to be used. The following numbers are self-explanatory: 2 - Double buffering 3 - Triple buffering

#### Additional information

The function needs to be called before creating the display driver device.

### 6.12.7.4 GUI\_MULTIBUF\_ConfigEx()

#### Description

The function needs to be called during initialization in order to enable the use of Multiple Buffering for the given layer. This is done typically from within `LCD_X_Config()`.

#### Prototype

```
void GUI_MULTIBUF_ConfigEx(int LayerIndex,  
                           int NumBuffers);
```

#### Parameters

Parameter	Description
<code>LayerIndex</code>	Layer to be used.
<code>NumBuffers</code>	Number of buffers to be used. The following numbers are self-explanatory: 2 - Double buffering 3 - Triple buffering

### 6.12.7.5 GUI\_MULTIBUF\_Confirm()

#### Description

This function needs to be called immediately after a new buffer has become visible.

#### Prototype

```
void GUI_MULTIBUF_Confirm(int BufferIndex);
```

#### Parameters

Parameter	Description
<a href="#">Index</a>	<a href="#">Index</a> of buffer which has been made visible.

#### Additional information

The function is typically called by the ISR which switches to the new front buffer or by the display driver callback function.



### 6.12.7.6 GUI\_MULTIBUF\_ConfirmEx()

#### Description

This function needs to be called immediately after a new buffer has become visible in the given layer.

#### Prototype

```
void GUI_MULTIBUF_ConfirmEx(int LayerIndex,  
                             int BufferIndex);
```

#### Parameters

Parameter	Description
<a href="#">LayerIndex</a>	Layer to be used.
<a href="#">Index</a>	<a href="#">Index</a> of buffer which has been made visible.

### 6.12.7.7 GUI\_MULTIBUF\_End()

#### Description

This function needs to be called after the new screen has been completely drawn.

#### Prototype

```
void GUI_MULTIBUF_End(void);
```

#### Additional information

When calling this function the display driver sends an `LCD_X_SHOWBUFFER` command to the display driver callback routine which then has to make the given buffer the front buffer.

### 6.12.7.8 GUI\_MULTIBUF\_EndEx()

#### Description

This function needs to be called after the new screen has been completely drawn for the given layer.

#### Prototype

```
void GUI_MULTIBUF_EndEx(int LayerIndex);
```

#### Parameters

Parameter	Description
<code>LayerIndex</code>	Layer to be used.

### 6.12.7.9 GUI\_MULTIBUF\_GetNumBuffers()

#### Description

The function returns the number of buffers configured.

#### Prototype

```
int GUI_MULTIBUF_GetNumBuffers(void);
```

#### Return value

The number of buffers configured for the current layer.

### 6.12.7.10 GUI\_MULTIBUF\_GetNumBuffersEx()

#### Description

The function returns the number of buffers configured for the given layer.

#### Prototype

```
int GUI_MULTIBUF_GetNumBuffersEx(int LayerIndex);
```

#### Parameters

Parameter	Description
LayerIndex	Layer to be used.

#### Return value

The number of buffers configured for the specified layer.

### 6.12.7.11 GUI\_MULTIBUF\_UseSingleBuffer()

#### Description

Lets the multi buffering use one frame for all layers.

#### Prototype

```
void GUI_MULTIBUF_UseSingleBuffer(void);
```

#### Additional information

The function needs to be called before creating the display driver device.

## 6.13 Keyboard Input

emWin provides support for any kind of keyboards. Any type of keyboard driver is compatible with emWin.

The software for keyboard input is located in the subdirectory `GUI\Core` and part of the basic package.

### 6.13.1 Description

A keyboard input device uses ASCII character coding in order to be able to distinguish between characters. For example, there is only one "A" key on the keyboard, but an uppercase "A" and a lowercase "a" have different ASCII codes (0x41 and 0x61, respectively).

#### emWin predefined character codes

emWin also defines character codes for other "virtual" keyboard operations. These codes are listed in the table below, and defined in an identifier table in `GUI.h`. A character code in emWin can therefore be any extended ASCII character value or any of the following predefined emWin values.

Predefined virtual key code	Description
<code>GUI_KEY_BACKSPACE</code>	Backspace key.
<code>GUI_KEY_TAB</code>	Tab key.
<code>GUI_KEY_BACKTAB</code>	Shift + Tab key.
<code>GUI_KEY_ENTER</code>	Enter/return key.
<code>GUI_KEY_LEFT</code>	Left arrow key.
<code>GUI_KEY_UP</code>	Up arrow key.
<code>GUI_KEY_RIGHT</code>	Right arrow key.
<code>GUI_KEY_DOWN</code>	Down arrow key.
<code>GUI_KEY_HOME</code>	Home key (move to beginning of current line).
<code>GUI_KEY_END</code>	End key (move to end of current line).
<code>GUI_KEY_SHIFT</code>	Shift key.
<code>GUI_KEY_CONTROL</code>	Control key.
<code>GUI_KEY_ESCAPE</code>	Escape key.
<code>GUI_KEY_INSERT</code>	Insert key.
<code>GUI_KEY_DELETE</code>	Delete key.
<code>GUI_KEY_SPACE</code>	Space key.
<code>GUI_KEY_PGUP</code>	Page up key.
<code>GUI_KEY_PGDOWN</code>	Page down key.

### 6.13.2 Driver layer API

The keyboard driver layer handles keyboard messaging functions. These routines notify the Window Manager when specific keys (or combinations of keys) have been pressed or released. The table below lists the driver-layer keyboard routines in alphabetical order. Detailed descriptions follow.

Routine	Description
<code>GUI_StoreKeyMsg()</code>	Stores a key message in the keyboard buffer.
<code>GUI_SendKeyMsg()</code>	Sends a key message to the window with the input focus.

### 6.13.2.1 GUI\_StoreKeyMsg()

#### Description

Stores a key message in the keyboard buffer.

#### Prototype

```
void GUI_StoreKeyMsg(int Key,  
                    int PressedCnt);
```

#### Parameters

Parameter	Description
<a href="#">Key</a>	May be any extended ASCII character (between 0x20 and 0xFF) or any predefined emWin character code.
<a href="#">Pressed</a>	<a href="#">Key</a> state. 1 for pressed state, 0 for released (unpressed) state.

#### Additional information

This function can be used from an interrupt service routine. The keyboard input manager of emWin contains a FIFO buffer which is able to hold up to 10 keyboard events per default. If a different size is required this value can be changed. Details can be found in the section *Advanced GUI configuration options* on page 138.

The Window Manager polls the keyboard buffer automatically and sends according keyboard messages to the currently focussed window.



## 6.13.2.2 GUI\_SendKeyMsg()

### Description

Sends a key message to the window with the input focus. If no window has the input focus, the function `GUI_StoreKeyMsg()` is called to store the data to the input buffer.

### Prototype

```
void GUI_SendKeyMsg(int Key,  
                  int PressedCnt);
```

### Parameters

Parameter	Description
<code>Key</code>	May be any extended ASCII character (between 0x20 and 0xFF) or any predefined emWin character code.
<code>Pressed</code>	<code>Key</code> state (see <code>GUI_StoreKeyMsg()</code> ).

### Additional information

This function should not be called from an interrupt service routine.

### 6.13.3 Application layer API

The table below lists the application-layer keyboard routines in alphabetical order. Detailed descriptions follow.

<b>Routine</b>	<b>Description</b>
<code>GUI_ClearKeyBuffer()</code>	Clears the key buffer.
<code>GUI_GetKey()</code>	Returns the key that was last written to the buffer.
<code>GUI_GetKeyPressed()</code>	Returns pressed state of the key that was last written to the buffer.
<code>GUI_GetKeyState()</code>	Returns the current key state.
<code>GUI_StoreKey()</code>	Stores a key in the buffer.
<code>GUI_WaitKey()</code>	Waits for a key to be pressed.

### 6.13.3.1 GUI\_ClearKeyBuffer()

#### Description

Clears the key buffer.

#### Prototype

```
void GUI_ClearKeyBuffer(void);
```

### 6.13.3.2 GUI\_GetKey()

#### Description

Returns the key that was last written to the buffer.

#### Prototype

```
int GUI_GetKey(void);
```

#### Return value

Codes of characters in the key buffer; 0 if no key is buffered.

### 6.13.3.3 GUI\_GetKeyPressed()

#### Description

Returns pressed state of the key that was last written to the buffer.

#### Prototype

```
int GUI_GetKeyPressed(void);
```

#### Return value

Pressed state of the key that was last written to the buffer.

#### Additional information

To get the state of the key which is returned by `GUI_GetKey()` this function should be called immediately before calling `GUI_GetKey()`.

### 6.13.3.4 GUI\_GetKeyState()

#### Description

Returns the current key state.

#### Prototype

```
void GUI_GetKeyState(GUI_KEY_STATE * pState);
```

#### Parameters

Parameter	Description
<code>pState</code>	Pointer to structure of type <code>GUI_KEY_STATE</code> which is filled by the function.

### 6.13.3.5 GUI\_StoreKey()

#### Description

Stores a key in the buffer.

#### Prototype

```
void GUI_StoreKey(int Key);
```

#### Parameters

Parameter	Description
Key	May be any extended ASCII character (between 0x20 and 0xFF) or any predefined emWin character code.

#### Additional information

This function is typically called by the driver and not by the application itself.

### 6.13.3.6 GUI\_WaitKey()

#### Description

Waits for a key to be pressed.

#### Prototype

```
int GUI_WaitKey(void);
```

#### Return value

The pressed key.

#### Additional information

The application is “blocked”, meaning it will not return until a key is pressed.



## 6.13.4 Data structure

### 6.13.4.1 GUI\_KEY\_STATE

#### Description

Data structure used to store a key state.

#### Type definition

```
typedef struct {  
    int Key;  
    int Pressed;  
} GUI_KEY_STATE;
```

#### Structure members

Member	Description
<a href="#">Key</a>	<a href="#">Key</a> code.
<a href="#">Pressed</a>	1, if the key is pressed. 0, if the key is not pressed. -1, if the state could not be determined.

## 6.14 Language Support

Text written in a language like Arabic, Thai or Chinese contains characters, which are normally not part of the fonts shipped with emWin. This chapter explains the basics like the Unicode standard, which defines all available characters worldwide and the UTF-8 encoding scheme, which is used by emWin to decode text with Unicode characters. It also explains how to enable bidirectional (and right to left) text support to be able to render Arabic or Hebrew scripts. A further subchapter explains how to render text with Shift-JIS (Japanese Industry Standard) encoding.

### 6.14.1 Unicode

Unicode is an international standard defined by the Unicode consortium. For each meaningful character or text element of all known cultures it contains a unique digital code point. Further it contains the bidirectional algorithm for right-to-left scripts like Hebrew and Arabic, which are also supported by emWin.

The Unicode Standard defines a codespace of 1,114,112 code points in the range from 0 to 0x10FFFF containing a repertoire of more than 128,000 characters covering more than 135 scripts. This codespace is divided into seventeen planes, numbered 0 to 16. emWin supports the complete *Basic Multilingual Plane* (BMP, plane 0) which covers the code points from 0x0000 to 0xFFFF. This BMP contains characters for almost all modern languages, and a large number of special characters. Characters outside the BMP are currently not supported.

#### 6.14.1.1 UTF-8 encoding

ISO/IEC 10646-1 defines a multi-octet character set called the Universal Character Set (UCS) which encompasses most of the world's writing systems. Multi-octet characters, however, are not compatible with many current applications and protocols, and this has led to the development of a few UCS transformation formats (UTF), each with different characteristics.

UTF-8 has the characteristic of preserving the full ASCII range, providing compatibility with file systems, parsers and other software that rely on ASCII values but are transparent to other values.

In emWin, UTF-8 characters are encoded using sequences of 1 to 3 octets. If the high-order bit is set to 0, the remaining 7 bits being used to encode the character value. In a sequence of  $n$  octets,  $n > 1$ , the initial octet has the  $n$  higher-order bits set to 1, followed by a bit set to 0. The remaining bit(s) of that octet contain bits from the value of the character to be encoded. The following octet(s) all have the higher-order bit set to 1 and the following bit set to 0, leaving 6 bits in each to contain bits from the character to be encoded.

The following table shows the encoding ranges:

Character range	UTF-8 Octet sequence
0000 - 007F	0xxxxxxxx
0080 - 07FF	110xxxxx 10xxxxxx
0800 - FFFF	1110xxxx 10xxxxxx 10xxxxxx

#### Encoding example

The text "Halöle" contains ASCII characters and European extensions. The following hex dump shows this text as UTF-8 encoded text:

```
48 61 6C C3 B6 6C 65
```

#### Programming examples

If we want to display a text containing non-ASCII characters, we can do this by manually computing the UTF-8 codes for the non-ASCII characters in the string. However, if

your compiler supports UTF-8 encoding (Sometimes called multi-byte encoding), even non-ASCII characters can be used directly in strings.

```
//
// Example using ASCII encoding:
//
GUI_UC_SetEncodeUTF8();      /* required only once to activate UTF-8*/
GUI_DispString("Hal\xc3\xb6le");
//
// Example using UTF-8 encoding:
//
GUI_UC_SetEncodeUTF8();      /* required only once to activate UTF-8*/
GUI_DispString("Halöle");
```

### 6.14.1.2 Unicode characters

The character output routine used by emWin (`GUI_DispChar()`) does always take an unsigned 16-bit value (U16) and has the basic ability to display a character defined by Unicode. It simply requires a font which contains the character you want to display.

### 6.14.1.3 UTF-8 strings

This is the most recommended way to display Unicode. You do not have to use special functions to do so. If UTF-8-encoding is enabled each function of emWin which handles with strings decodes the given text as UTF-8 text.

#### 6.14.1.3.1 Using U2C.exe to convert UTF-8 text into C code

The `Tool` subdirectory of emWin contains the tool `U2C.exe` to convert UTF-8 text to C code. It reads an UTF-8 text file and creates a C file with C strings. The following steps show how to convert a text file into C strings and how to display them with emWin:

##### Step 1: Creating a UTF-8 text file

Save the text to be converted in UTF-8 format. You can use `Notepad.exe` to do this. Load the text under `Notepad.exe`:

```
Japanese:
1 - エンコーディング
2 - テキスト
3 - サポート
English:
1 - encoding
2 - text
3 - support
```

Choose **File** → **Save As...** The file dialog should contain a combo box to set the encoding format. Choose "UTF-8" and save the text file.

##### Step 2: Converting the text file into a C-code file

Start `U2C.exe`. After starting the program you need to select the text file to be converted. After selecting the text file the name of the C file should be selected. Output of `U2C.exe`:

```
"Japanese:"
"1 - \xe3\x82\xa8\xe3\x83\xb3\xe3\x82\xb3\xe3\x83\xbc"
  "\xe3\x83\x87\xe3\x82\xa3\xe3\x83\xb3\xe3\x82\xb0"
"2 - \xe3\x83\x86\xe3\x82\xad\xe3\x82\xb9\xe3\x83\x88"
"3 - \xe3\x82\xb5\xe3\x83\x9d\xe3\x83\xbc\xe3\x83\x88"
"English:"
"1 - encoding"
```

```
"2 - text"  
"3 - support"
```

### Step 3: Using the output in the application code

The following example shows how to display the UTF-8 text with emWin:

```
#include "GUI.h"  
static const char * _apStrings[] = {  
    "Japanese:",  
    "\xe3\x82\xa8\xe3\x83\xb3\xe3\x82\xb3\xe3\x83xbc"  
    "\xe3\x83\x87\xe3\x82\xa3\xe3\x83\xb3\xe3\x82\xb0",  
    "2 - \xe3\x83\x86\xe3\x82\xad\xe3\x82\xb9\xe3\x83\x88",  
    "3 - \xe3\x82\xb5\xe3\x83\x9d\xe3\x83xbc\xe3\x83\x88",  
    "English:",  
    "1 - encoding",  
    "2 - text",  
    "3 - support"  
};  
void MainTask(void) {  
    int i;  
    GUI_Init();  
    GUI_SetFont(&GUI_Font16_1HK);  
    GUI_UC_SetEncodeUTF8();  
    for (i = 0; i < GUI_COUNTOF(_apStrings); i++) {  
        GUI_DispString(_apStrings[i]);  
        GUI_DispNextLine();  
    }  
    while(1) {  
        GUI_Delay(500);  
    }  
}
```

### 6.14.1.4 Unicode API

The table below lists the available routines in alphabetical order within their respective categories. Detailed descriptions of the routines can be found in the sections that follow.

Routine	Description
UTF-8 functions	
<code>GUI_UC_ConvertUC2UTF8()</code>	Converts the given double byte Unicode string into UTF-8 format.
<code>GUI_UC_ConvertUTF82UC()</code>	Converts the given UTF-8 string into Unicode format.
<code>GUI_UC_EnableBIDI()</code>	This function enables support for bidirectional text.
<code>GUI_UC_EnableThai()</code>	This function enables support for Thai script.
<code>GUI_UC_Encode()</code>	This function encodes a given character with the current encoding settings.
<code>GUI_UC_GetBaseDir()</code>	Returns the current basic text direction.
<code>GUI_UC_GetCharCode()</code>	This function decodes a character from a given text.
<code>GUI_UC_GetCharSize()</code>	This function returns the number of bytes used to encode the given character.
<code>GUI_UC_SetBaseDir()</code>	Sets the basic text direction to be used.
<code>GUI_UC_SetEncodeSJIS()</code>	Enables SJIS character encoding.
<code>GUI_UC_SetEncodeNone()</code>	Disables character encoding.
<code>GUI_UC_SetEncodeUTF8()</code>	Enables UTF-8 encoding.
Double byte functions	
<code>GUI_UC_DispString()</code>	This function displays the given double byte string.

### 6.14.1.4.1 UTF-8 functions

#### 6.14.1.4.1.1 GUI\_UC\_ConvertUC2UTF8()

##### Description

Converts the given double byte Unicode string into UTF-8 format.

##### Prototype

```
int GUI_UC_ConvertUC2UTF8(const U16 * s,  
                          int      Len,  
                          char * pBuffer,  
                          int      BufferSize);
```

##### Parameters

Parameter	Description
<code>s</code>	Pointer to Unicode string to be converted.
<code>Len</code>	Number of Unicode characters to be converted.
<code>pBuffer</code>	Pointer to a buffer to write in the result.
<code>BufferSize</code>	Buffer size in bytes.

##### Return value

The function returns the number of bytes written to the buffer.

##### Additional information

UTF-8 encoded characters can use up to 3 bytes. To be on the safe side the recommended buffer size is: `Number of Unicode characters * 3`.

If the buffer is not big enough for the whole result, the function returns when the buffer is full.

### 6.14.1.4.1.2 GUI\_UC\_ConvertUTF82UC()

#### Description

Converts the given UTF-8 string into Unicode format.

#### Prototype

```
int GUI_UC_ConvertUTF82UC(const char * s,  
                          int      Len,  
                          U16     * pBuffer,  
                          int      BufferSize);
```

#### Parameters

Parameter	Description
<code>s</code>	Pointer to UTF-8 string to be converted.
<code>Len</code>	Length in bytes of the string to be converted.
<code>pBuffer</code>	Pointer to a buffer to write in the result.
<code>BufferSize</code>	Buffer size in words.

#### Return value

The function returns the number of Unicode characters written to the buffer.

#### Additional information

If the buffer is not big enough for the whole result, the function returns when the buffer is full.

### 6.14.1.4.1.3 GUI\_UC\_EnableBIDI()

#### Description

This function enables support for bidirectional text.

#### Prototype

```
int GUI_UC_EnableBIDI(int OnOff);
```

#### Parameters

Parameter	Description
OnOff	1 to enable BIDI support, 0 to disable it.

#### Return value

The previous state of BIDI support.

#### Additional information

Once this function is linked approximately 97 KBytes of ROM are additionally used (about 25 KBytes of code and 72 KByte const data). The BiDi module uses a look up table for some characters. This table requires about 72 KByte of ROM. It is possible to reduce the size of this table by enabling (1) or disabling (0) code points with the following:

```
#define GUI_BIDI_SUPPORT_RANGE_<X> 0
```

Where <X> can be 0, 1, 2, 3, 4, A, D, F and represents the first digit of the according Unicode range.

For example:

```
#define GUI_BIDI_SUPPORT_RANGE_2 0
#define GUI_BIDI_SUPPORT_RANGE_F 0
```

The above example excludes all character information of the codepoint ranges 0x2000-0x2FFF and 0xF000-0xFFFF.



#### 6.14.1.4.1.4 GUI\_UC\_EnableThai()

##### Description

This function enables support for Thai script.

##### Prototype

```
int GUI_UC_EnableThai(int OnOff);
```

##### Parameters

Parameter	Description
OnOff	1 to enable Thai support, 0 to disable it.

##### Return value

The previous state of Thai support.

##### Additional information

If Thai support is enabled emWin observes 2 situations:

1. If a consonant is followed by a lower vowel the pixel area below the base line must be clipped.
2. If a tone mark should be drawn after an upper vowel the tone mark has to be shifted up to make it visible above the tone mark.

### 6.14.1.4.1.5 GUI\_UC\_Encode()

#### Description

This function encodes a given character with the current encoding settings.

#### Prototype

```
int GUI_UC_Encode(char * s,  
                 U16  Char);
```

#### Parameters

Parameter	Description
s	Pointer to a buffer to store the encoded character.
Char	Character to be encoded.

#### Return value

The number of bytes stored to the buffer.

#### Additional information

The function assumes that the buffer has at least 3 bytes for the result.

#### 6.14.1.4.1.6 GUI\_UC\_GetBaseDir()

##### Description

Returns the current basic text direction.

##### Prototype

```
int GUI_UC_GetBaseDir(void);
```

##### Return value

Basic text direction.

#### 6.14.1.4.1.7 GUI\_UC\_GetCharCode()

##### Description

This function decodes a character from a given text.

##### Prototype

```
U16 GUI_UC_GetCharCode(const char * s);
```

##### Parameters

Parameter	Description
<code>s</code>	Pointer to the text to be encoded.

##### Return value

The encoded character.

### 6.14.1.4.1.8 GUI\_UC\_GetCharSize()

#### Description

This function returns the number of bytes used to encode the given character.

#### Prototype

```
int GUI_UC_GetCharSize(const char * s);
```

#### Parameters

Parameter	Description
s	Pointer to the text to be encoded.

#### Return value

Number of bytes used to encode the given character.

#### Additional information

This function is used to determine how much bytes a pointer has to be incremented to point to the next character.

#### Example

The following example shows how to use the function:

```
static void _Display2Characters(const char * pText) {
    int Size;
    U16 Character;
    Size      = GUI_UC_GetCharSize(pText); // Size to increment pointer
    Character = GUI_UC_GetCharCode(pText); // Get first character code
    GUI_Dispatch(Character);              // Display first character
    pText    += Size;                     // Increment pointer
    Character = GUI_UC_GetCharCode(pText); // Get next character code
    GUI_Dispatch(Character);              // Display second character
}
```

### 6.14.1.4.1.9 GUI\_UC\_SetBaseDir()

#### Description

Sets the basic text direction to be used.

#### Prototype

```
void GUI_UC_SetBaseDir(int Dir);
```

#### Parameters

Parameter	Description
<a href="#">Dir</a>	(see table below)

Permitted values for element <a href="#">Dir</a>	
GUI_BIDI_BASEDIR_LTR	Basic text direction is 'left to right'.
GUI_BIDI_BASEDIR_RTL	Basic text direction is 'right to left'.
GUI_BIDI_BASEDIR_AUTO	Basic text direction is calculated automatically: If the first character with strong directionality is RTL the basic text direction is set to RTL.

#### 6.14.1.4.1.10 GUI\_UC\_SetEncodeSJIS()

##### Description

Enables SJIS character encoding.

##### Prototype

```
void GUI_UC_SetEncodeSJIS(void);
```

##### Additional information

This function call is required before using an SJIS font.

#### 6.14.1.4.1.11 GUI\_UC\_SetEncodeNone()

##### Description

Disables character encoding.

##### Prototype

```
void GUI_UC_SetEncodeNone(void);
```

##### Additional information

After calling this function each byte of a text will be handled as one character. This is the default behavior of emWin.



#### 6.14.1.4.1.12 GUI\_UC\_SetEncodeUTF8()

##### Description

Enables UTF-8 encoding.

##### Prototype

```
void GUI_UC_SetEncodeUTF8(void);
```

##### Additional information

After calling `GUI_UC_SetEncodeUTF8()` each string related routine of emWin encodes a given sting in accordance to the UTF-8 transformation.

## 6.14.1.4.2 Double byte functions

### 6.14.1.4.2.1 GUI\_UC\_DispString()

#### Description

This function displays the given double byte string.

#### Prototype

```
void GUI_UC_DispString(const U16 * s);
```

#### Parameters

Parameter	Description
s	Pointer to double byte string.

#### Additional information

If you need to display double byte strings you should use this function. Each character has to be defined by a 16 bit value.

## 6.14.2 Text- and language resource files

To be able to change the text of an application without modifying one line of code the text- and language resource file API functions can be used. They offer the possibility to use one or more simple text files or one CSV (**C**omma **S**eparated **V**alue) file containing text in multiple languages. These files can reside in addressable RAM or at any non addressable medium like NAND flash or a file system.

### 6.14.2.1 Unicode support

If the used range of characters exceeds the ASCII set the text files should contain UTF-8 text. Other encodings like UC16 are not supported by this module.

### 6.14.2.2 Loading files from RAM

When using the files directly from RAM emWin does not allocate the required strings again. It uses the RAM location of the files directly. But because text- and CSV files do not contain zero delimited strings, emWin modifies the given text by replacing the line delimiters (CRLF) (text files) or field delimiters (CSV files) by a zero byte. Therefore the files have to reside in RAM, not in ROM.

### 6.14.2.3 Loading files from non addressable areas

It is also possible to use the files from non addressable areas or any other location in ROM. In these cases emWin uses a GetData function for getting the file data. In the first step (`GUI_LANG_LoadTextEx()`, `GUI_LANG_LoadCSVEx()`) emWin only remembers size and file offset of the text locations within the files. Only when accessing the text with `GUI_LANG_GetText()` the text will be allocated in RAM, read from the file and converted in a legal zero delimited string.

Each time a string gets return by `GUI_LANG_GetText()` it stores the string in the RAM. Once a string is located in the RAM the function returns the string from the RAM. This makes the reading process much faster. If there is not much RAM available it is possible to use the function `GUI_LANG_GetTextBuffered()`. This function uses a buffer of a fixed size and does not keep the string to be displayed in RAM. On the other hand this requires more reading accesses and is slower than reading the string from RAM.

### 6.14.2.4 Rules for CSV files

Because the term 'CSV file' does not exactly determine the file format, here are the rules which have to be obeyed:

- Each record is located on a separate line, delimited by a line break (CRLF).
- The last record in the file may or may not have an ending line break.
- Within each record, there may be one or more fields, separated by delimiters. Each line should contain the same number of fields throughout the file. Spaces are considered part of a field. The last field in the record must not be followed by a delimiter.
- Default field delimiter is a comma. This may be changed using the function `GUI_LANG_SetSep()`.
- Each field may or may not be enclosed in double quotes. If fields are not enclosed with double quotes, then double quotes may not appear inside the fields.
- Fields containing line breaks (CRLF), double quotes, and commas should be enclosed in double-quotes.
- If double-quotes are used to enclose fields, then a double-quote appearing inside a field must be escaped by preceding it with another double quote.

### 6.14.2.5 Rules for text files

A text file is a simple file where each line contains one text element. Rules to obey:

- Each line contains one text item.
- Each line must be delimited by a line break (CRLF).
- Line breaks within a text item are to be specified with `"\n"`.

- Backslashes can be escaped with another backslash (“\\”).
- All other escaped characters (e.g. “\r”) will be ignored and not resolved.

### 6.14.2.6 Text- and language resource file API

The table below shows the available routines in alphabetical order. Detailed descriptions of the routines follow.

#### Functions

Routine	Description
Text file functions	
<code>GUI_LANG_LoadText()</code>	Loads a text file from a RAM location.
<code>GUI_LANG_LoadTextEx()</code>	Loads a text file using the given <code>GetData</code> function from any area.
CSV file functions	
<code>GUI_LANG_LoadCSV()</code>	Loads a CSV file from a RAM location.
<code>GUI_LANG_LoadCSVEx()</code>	Loads a CSV file from any location by using a <code>GetData</code> function.
Common functions	
<code>GUI_LANG_Clear()</code>	Frees all allocated resources.
<code>GUI_LANG_GetLang()</code>	Returns the current language index.
<code>GUI_LANG_GetNumItems()</code>	Returns the number of available text items of the given language.
<code>GUI_LANG_GetText()</code>	Returns a pointer to the requested text item of the current language.
<code>GUI_LANG_GetTextBuffered()</code>	Copies the requested text of the current language into the given buffer.
<code>GUI_LANG_GetTextBufferedEx()</code>	Copies the requested text of the given language into the given buffer.
<code>GUI_LANG_GetTextEx()</code>	Returns a pointer to the requested text item.
<code>GUI_LANG_GetTextLen()</code>	Returns the length of a text item of the current language.
<code>GUI_LANG_GetTextLenEx()</code>	Returns the length of a text item.
<code>GUI_LANG_SetLang()</code>	Sets the language to be used by the function <code>GUI_LANG_GetText()</code> .
<code>GUI_LANG_SetMaxNumLang()</code>	Sets the maximum number of languages to be used.
<code>GUI_LANG_SetSep()</code>	Sets the separator to be used when reading a CSV file.

#### Prototypes

Prototype	Description
<code>GUI_LANG_GET_DATA_FUNC</code>	<code>GetData</code> function used for the language module, for more details see <code>GUI_GET_DATA_FUNC_I I</code> .

## 6.14.2.6.1 Functions

### 6.14.2.6.1.1 GUI\_LANG\_LoadText()

#### Description

Loads a text file from a RAM location.

#### Prototype

```
int GUI_LANG_LoadText(U8 * pFileData,  
                    U32  FileSize,  
                    int  IndexLang);
```

#### Parameters

Parameter	Description
<code>pFileData</code>	Pointer to the first byte of the file.
<code>FileSize</code>	Size of the given file in bytes.
<code>IndexLang</code>	Index of the language.

#### Return value

0        on success.  
1        on error.

#### Additional information

The given file needs to reside in RAM. As explained at the beginning of the chapter emWin converts the given text items into zero delimited strings.

### 6.14.2.6.1.2 GUI\_LANG\_LoadTextEx()

#### Description

Loads a text file using the given `GetData` function from any area.

#### Prototype

```
int GUI_LANG_LoadTextEx(GUI_LANG_GET_DATA_FUNC * pfGetData,
                       void * p,
                       int IndexLang);
```

#### Parameters

Parameter	Description
<code>pfGetData</code>	<b>in</b> Function pointer to a <code>GetData</code> function. For more details, please refer to the chapter <i>FileAccess</i> on page 3219.
<code>p</code>	<b>in</b> Pointer passed to the <code>GetData()</code> function.
<code>IndexLang</code>	Index of the language.

#### Return value

- 0 on success.
- 1 on error.

#### Additional information

Data is accessed by the given `GetData` function. The pointer `p` can be used by the application.

#### Prototype of the 'GetData' function

```
int GUI_GET_DATA_FUNC( void * p,
                       const U8 * * ppData,
                       unsigned NumBytesReq,
                       U32 Off);
```

Parameter	Description
<code>p</code>	Application defined void pointer.
<code>ppData</code>	The location the pointer points to has to be filled by the 'GetData' function.
<code>NumBytesReq</code>	Number of requested bytes.
<code>Off</code>	Offset to be used to address the requested bytes within the file.

#### Example

The following shows a sample implementation of the `GetData` function for use under Windows:

```
static int _GetData(void * pVoid, const U8 ** ppData, unsigned NumBytes, U32 Off) {
    DWORD NumBytesRead;
    HANDLE hFile;
    U8 * pData;
    pData = (U8 *)*ppData;
    hFile = *(HANDLE *)pVoid;
    if (SetFilePointer(hFile, Off, 0, FILE_BEGIN) == 0xFFFFFFFF) {
        return 0;
    }
    if (!ReadFile(hFile, pData, NumBytes, &NumBytesRead, 0)) {
        return 0;
    }
    return NumBytesRead;
}
```

```
}
```



### 6.14.2.6.1.3 GUI\_LANG\_LoadCSV()

#### Description

Loads a CSV file from a RAM location.

#### Prototype

```
int GUI_LANG_LoadCSV(U8 * pFileData,  
                    U32  FileSize);
```

#### Parameters

Parameter	Description
<code>pFileData</code>	Pointer to the first byte of the file.
<code>FileSize</code>	Size of the given file in bytes.

#### Return value

The function returns the number of available languages of the given file.

#### Additional information

The given file needs to reside in RAM. As explained at the beginning of the chapter emWin converts the given text items to zero delimited strings. This function call first deletes all existing text resources. It is not possible to use a text file including one language and a CSV file including further languages. Either text files or CSV files should be used.

#### 6.14.2.6.1.4 GUI\_LANG\_LoadCSVEx()

##### Description

Loads a CSV file from any location by using a `GetData` function.

##### Prototype

```
int GUI_LANG_LoadCSVEx(GUI_LANG_GET_DATA_FUNC * pfGetData,  
                      void * p);
```

##### Parameters

Parameter	Description
<code>pfGetData</code>	<b>in</b> Function pointer to a <code>GetData</code> function. For more details, please refer to the chapter <i>FileAccess</i> on page 3219.
<code>p</code>	<b>in</b> Pointer passed to the <code>GetData()</code> function.

##### Return value

The function returns the number of available languages.

##### Additional information

As explained at the beginning of the chapter `emWin` converts the given text items to zero delimited strings. This function call first deletes all existing text resources. It is not possible to use a text file including one language and a CSV file including further languages. Either text files or CSV files should be used. If the return value is 0 it might be possible that the maximum number of languages is too small. Call `GUI_LANG_SetMaxNumLang()` to increase the number of languages.

### 6.14.2.6.1.5 GUI\_LANG\_Clear()

#### Description

Frees all allocated resources.

#### Prototype

```
void GUI_LANG_Clear(void);
```

#### 6.14.2.6.1.6 GUI\_LANG\_GetLang()

##### Description

Returns the current language index.

##### Prototype

```
int GUI_LANG_GetLang(void);
```

##### Return value

Current index of the language.

### 6.14.2.6.1.7 GUI\_LANG\_GetNumItems()

#### Description

Returns the number of available text items of the given language.

#### Prototype

```
int GUI_LANG_GetNumItems(int IndexLang);
```

#### Parameters

Parameter	Description
<code>IndexLang</code>	Index of the given language.

#### Return value

Number of available text items of the given language.

### 6.14.2.6.1.8 GUI\_LANG\_GetText()

#### Description

Returns a pointer to the requested text item of the current language.

#### Prototype

```
char *GUI_LANG_GetText(int IndexText);
```

#### Parameters

Parameter	Description
IndexText	Index of the text item to be returned.

#### Return value

Pointer to the requested text item.

#### Additional information

If a `GetData` function is used, the first time a text item is requested it will be allocated, read and converted once. In case of using a `GetData` function this could save memory if not all text items are used by the application.

### 6.14.2.6.1.9 GUI\_LANG\_GetTextBuffered()

#### Description

Copies the requested text of the current language into the given buffer.

#### Prototype

```
int GUI_LANG_GetTextBuffered(int IndexText,  
                             char * pBuffer,  
                             int SizeOfBuffer);
```

#### Parameters

Parameter	Description
<a href="#">IndexText</a>	Index of the text item to be returned.
<a href="#">pBuffer</a>	Pointer to an application defined buffer.
<a href="#">SizeOfBuffer</a>	Size of the application defined buffer.

#### Return value

- 0 on success.
- 1 if the text could not be found.

### 6.14.2.6.1.10 GUI\_LANG\_GetTextBufferedEx()

#### Description

Copies the requested text of the given language into the given buffer.

#### Prototype

```
int GUI_LANG_GetTextBufferedEx(int    IndexText,
                               int    IndexLang,
                               char * pBuffer,
                               int    SizeOfBuffer);
```

#### Parameters

Parameter	Description
<a href="#">IndexText</a>	Index of the text item to be returned.
<a href="#">IndexLang</a>	Index of the language.
<a href="#">pBuffer</a>	Pointer to an application defined buffer.
<a href="#">SizeOfBuffer</a>	Size of the application defined buffer.

#### Return value

- 0        on success.
- 1        if the text could not be found.



### 6.14.2.6.1.11 GUI\_LANG\_GetTextEx()

#### Description

Returns a pointer to the requested text item.

#### Prototype

```
char *GUI_LANG_GetTextEx(int IndexText,  
                        int IndexLang);
```

#### Parameters

Parameter	Description
<a href="#">IndexText</a>	Index of the text item to be returned.
<a href="#">IndexLang</a>	Index of the requested language.

#### Return value

≠ NULL Pointer to the requested text item.  
= NULL Invalid parameters or not enough memory available.

#### Additional information

If a `GetData` function is used, the first time a text item is requested it will be allocated, read and converted once. In case of using a `GetData` function this could save memory if not all text items are used by the application.

Please note that this function allocates a fixed memory block which can lead to bigger memory holes. It is more recommended to use `GUI_LANG_GetTextBuffered()` or `GUI_LANG_GetTextBufferedEx()` since these functions do not allocate memory.

When `GUI_LANG_Clear()` is called, the buffers allocated by this function will be freed. If the language text is still required after `GUI_LANG_Clear()` has been called, `GUI_LANG_GetTextBuffered()/GUI_LANG_GetTextBufferedEx()` should be used instead.

### 6.14.2.6.1.12 GUI\_LANG\_GetTextLen()

#### Description

Returns the length of a text item of the current language.

#### Prototype

```
int GUI_LANG_GetTextLen(int IndexText);
```

#### Parameters

Parameter	Description
<code>IndexText</code>	Index of the text item.

#### Return value

-1      Error. != -1: Length of the text item.

### 6.14.2.6.1.13 GUI\_LANG\_GetTextLenEx()

#### Description

Returns the length of a text item.

#### Prototype

```
int GUI_LANG_GetTextLenEx(int IndexText,  
                          int IndexLang);
```

#### Parameters

Parameter	Description
<a href="#">IndexText</a>	Index of the text item.
<a href="#">IndexLang</a>	Index of the language.

#### Return value

-1 Error. != -1: Length of the text item.

#### 6.14.2.6.1.14 GUI\_LANG\_SetLang()

##### Description

Sets the language to be used by the function `GUI_LANG_GetText()`.

##### Prototype

```
int GUI_LANG_SetLang(int IndexLang);
```

##### Parameters

Parameter	Description
<code>IndexLang</code>	Index of the language to be used.

##### Return value

Previous index of the language.

### 6.14.2.6.1.15 GUI\_LANG\_SetMaxNumLang()

#### Description

Sets the maximum number of languages to be used.

#### Prototype

```
unsigned GUI_LANG_SetMaxNumLang(unsigned MaxNumLang);
```

#### Parameters

Parameter	Description
<a href="#">MaxNumLang</a>	Maximum number of languages

#### Return value

Previous maximum number of languages.

#### Additional information

This function has to be called before any other function of the language module is called. A good place for the function call would be `GUI_X_Config()`.

### 6.14.2.6.1.16 GUI\_LANG\_SetSep()

#### Description

Sets the separator to be used when reading a CSV file.

#### Prototype

```
U16 GUI_LANG_SetSep(U16 Sep);
```

#### Parameters

Parameter	Description
<a href="#">Sep</a>	Separator to be used for CSV files.

#### Return value

Previously used separator.

#### Additional information

The default separator is a comma. Some applications use TABs or semicolons as separator. This function can be used to change the separator. It does not check if the given separator makes sense. So it is the applications responsibility to set the right value. The function has no effect on reading text files.

## 6.14.2.6.2 Prototypes

### 6.14.2.6.2.1 GUI\_LANG\_GET\_DATA\_FUNC

#### Description

GetData function used for the language module, for more details see `GUI_GET_DATA_FUNC_II`.

#### Type definition

```
typedef GUI_GET_DATA_FUNC_II GUI_LANG_GET_DATA_FUNC;
```

### 6.14.3 Right to left- and bidirectional text

Whereas most scripts are written from the left to the right (LTR), there are some scripts like Hebrew and Arabic which are written from the right to the left (RTL). Bidirectional (BIDI) text contains text with both directionalities. To be able to apply the correct visual alignment, a couple of rules need to be followed to get the right visual alignment of the text. BIDI text support is part of the emWin basic package.

#### 6.14.3.1 Bidirectional text algorithm

The Unicode consortium has defined the rules for combining RTL- and LTR text in the Unicode standard. It prescribes an algorithm for how to convert the logical sequence of characters into the correct visual presentation observing a set of rules. emWin follows up these rules to get the right visual order before drawing the text. It observes the rules of the bidirectional text algorithm of the Unicode standard 8.0.0.

#### Example

The following example shows how bidirectional text is rendered by emWin:

UTF-8 text	Rendering
<pre>\xd8\xb9\xd9\x84\xd8\xa7 1, 2, 345 \xd8\xba\xd9\x86\xd9\x8a XYZ \xd8\xa3\xd9\x86\xd8\xa7</pre>	علا 1, 2, 345 غني XYZ أنا

#### 6.14.3.2 Basic text direction

It is important to set the appropriate base direction for text so that the bidirectional algorithm produces the expected ordering of the text. The visual order of text, especially text with brackets and single RTL characters, depends on the basic text direction.

#### Example

The following example shows a simple text with different basic text directions:

Basic text direction	Rendering
GUI_BIDI_BASEDIR_RTL	({Arabic letter Meem})
GUI_BIDI_BASEDIR_AUTO	({Arabic letter Meem})

#### 6.14.3.3 Mirroring

emWin also supports mirroring of some neutral characters in RTL aligned text. This is important if for example RTL aligned text contains parenthesis. The mirroring is done by replacing the code of the character to be mirrored with the code of a mirror partner whose image fits to the mirrored image. This is done by a fast way using a table containing all characters with existing mirror partners. Note that support for mirroring further characters is not supported.

#### 6.14.3.4 ROM and stack requirement

The bidirectional text alignment uses approx. 80 KB of ROM and approx. 800 bytes of additional stack.

#### Reducing ROM requirement

The above mentioned ROM requirement is caused by a large table with information of the BiDi category for each character. If the application do not require the complete range of



codepoints (0x0000 - 0xFFFF) the ROM requirement can be reduced. For detailed information please refer to *GUI\_UC\_EnableBIDI* on page 904.

### 6.14.3.5 Maximum characters per line

The maximum number of characters in bidirectional text **per line** is limited to 200 by default. In case this has to be changed, e.g. if more characters are needed, the user may change the define `GUI_BIDI_MAX_CHARS_PER_LINE` located in the file `GUI_ConfDefaults.h`. Note that one character equals to 4 bytes of stack needed.

```
#define GUI_BIDI_MAX_CHARS_PER_LINE 200
```

## 6.14.4 Arabic support

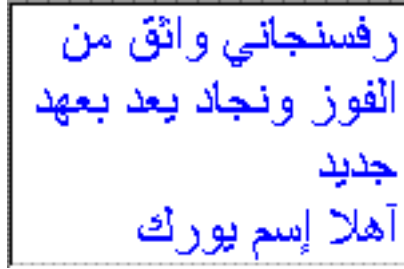

The basic difference between western languages and Arabic is, that Arabic scripts are written from the right to the left and that it does not know uppercase and lowercase characters. Further the character codes of the text are not identical with the character index in the font file used to render the character, because the notation forms of the characters depend on the positions in the text. Arabic support is part of the emWin basic package.

### 6.14.4.1 Notation forms

The Arabic base character set is defined in the Unicode standard within the range from 0x0600 to 0x06FF. Unfortunately these character codes can not directly be used to get the character of the font for drawing it, because the notation form depends on the character position in the text. One character can have up to 4 different notation forms:

- One, if it is at the beginning of a word (**initial**)
- One, if it is at the end of a word (**final**)
- One, if it is in the middle of a word (**medial**)
- One, if the character stands alone (**isolated**)

But not each character is allowed to be joined to the left and to the right (double-joined). The character Hamza for example always needs to be separated and Alef is only allowed at the end or separated. Character combinations of the letters Lam and Alef should be transformed to a ligature. This means one character substitutionally for the combination of Lam and Alef.

The above description shows, that the notation form is normally not identical to the character code of the text. The following table shows how emWin transforms the characters to the notation form in dependence of the text position:

Base	Isolated	Final	Initial	Medial	Character
0x0621	0xFE80	-	-	-	Hamza
0x0622	0xFE81	0xFE82	-	-	Alef with Madda above
0x0623	0xFE83	0xFE84	-	-	Alef with Hamza above
0x0624	0xFE85	0xFE86	-	-	Waw with Hamza above
0x0625	0xFE87	0xFE88	-	-	Alef with Hamza below
0x0626	0xFE89	0xFE8A	0xFE8B	0xFE8C	Yeh with Hamza above
0x0627	0xFE8D	0xFE8E	-	-	Alef
0x0628	0xFE8F	0xFE90	0xFE91	0xFE92	Beh
0x0629	0xFE93	0xFE94	-	-	Teh Marbuta
0x062A	0xFE95	0xFE96	0xFE97	0xFE98	Teh
0x062B	0xFE99	0xFE9A	0xFE9B	0xFE9C	Theh
0x062C	0xFE9D	0xFE9E	0xFE9F	0xFE9A0	Jeem

Base	Isolated	Final	Initial	Medial	Character
0x062D	0xFEA1	0xFEA2	0xFEA3	0xFEA4	Hah
0x062E	0xFEA5	0xFEA6	0xFEA7	0xFEA8	Khah
0x062F	0xFEA9	0xFEAA	-	-	Dal
0x0630	0xFEAB	0xFEAC	-	-	Thal
0x0631	0xFEAD	0xFEAE	-	-	Reh
0x0632	0xFEAF	0xFEB0	-	-	Zain
0x0633	0xFEB1	0xFEB2	0xFEB3	0xFEB4	Seen
0x0634	0xFEB5	0xFEB6	0xFEB7	0xFEB8	Sheen
0x0635	0xFEB9	0xFEBA	0xFEBB	0xFEBC	Sad
0x0636	0xFEBD	0xFEBE	0xFEBF	0xFEC0	Dad
0x0637	0xFEC1	0xFEC2	0xFEC3	0xFEC4	Tah
0x0638	0xFEC5	0xFEC6	0xFEC7	0xFEC8	Zah
0x0639	0xFEC9	0xFECA	0xFECB	0xFECC	Ain
0x063A	0xFECD	0xFECE	0xFECF	0xFED0	Ghain
0x0641	0xFED1	0xFED2	0xFED3	0xFED4	Feh
0x0642	0xFED5	0xFED6	0xFED7	0xFED8	Qaf
0x0643	0xFED9	0xFEDA	0xFEDB	0xFEDC	Kaf
0x0644	0xFEDD	0xFEDE	0xFEDF	0xFEE0	Lam
0x0645	0xFEE1	0xFEE2	0xFEE3	0xFEE4	Meem
0x0646	0xFEE5	0xFEE6	0xFEE7	0xFEE8	Noon
0x0647	0xFEE9	0xFEEA	0xFEEB	0xFEEC	Heh
0x0648	0xFEED	0xFEEE	-	-	Waw
0x0649	0xFEEF	0xFEFO	-	-	Alef Maksura
0x064A	0xFEFF	0xFEFF	0xFEFF	0xFEFF	Yeh
0x067E	0xFB56	0xFB57	0xFB58	0xFB59	Peh
0x0686	0xFB7A	0xFB7B	0xFB7C	0xFB7D	Tchah
0x0698	0xFB8A	0xFB8B	-	-	Jeh
0x06A9	0xFB8E	0xFB8F	0xFB90	0xFB91	Keheh
0x06AF	0xFB92	0xFB93	0xFB94	0xFB95	Gaf
0x06CC	0xFBFC	0xFBFD	0xFBFE	0xFBFF	Farsi Yeh

### 6.14.4.2 Ligatures

Character combinations of Lam and Alef are transformed into ligatures. The following table shows how emWin transforms these combinations into ligatures, if the first letter is a Lam (code 0x0644):

Second letter	Ligature (final)	Ligature (elsewhere)
0x622, Alef with Madda above	0xFEFF6	0xFEFF5
0x623, Alef with Hamza above	0xFEFF8	0xFEFF7
0x625, Alef with Hamza below	0xFEFFA	0xFEFF9
0x627, Alef	0xFEFFC	0xFEFFB

### 6.14.4.3 How to enable Arabic support

Per default emWin writes text always from the left to the right and there will be no Arabic character transformation as described above. To enable support for bidirectional text and Arabic character transformation, add the following line to your application:

```
GUI_UC_EnableBIDI(1);
```

If enabled, emWin follows the rules of the bidirectional algorithm, described by the Unicode consortium, to get the right visual order before drawing text.

### 6.14.4.4 Example

The `Sample` folder contains the example `FONT_Arabic`, which shows how to draw Arabic text. It contains an emWin font with Arabic characters and some small Arabic text examples.

### 6.14.4.5 Font files used with Arabic text

Font files used to render Arabic text need to include at least all characters defined in the Arabic range `0x600-0x6FF` and the notation forms and ligatures listed in the tables of this chapter.

## 6.14.5 Thai language support

Nice to meet you.

ยินดีที่ได้รู้จัก

The Thai alphabet uses 44 consonants and 15 basic vowel characters. These are horizontally placed, left to right, with no intervening space, to form syllables, words, and sentences. Vowels are written above, below, before, or after the consonant they modify, although the consonant always sounds first when the syllable is spoken. The vowel characters (and a few consonants) can be combined in various ways to produce numerous compound vowels (diphthongs and triphthongs).

### 6.14.5.1 Requirements

As explained above the Thai language makes an extensive usage of compound characters. To be able to draw compound characters in emWin, a new font type is needed, which contains all required character information like the image size, image position and cursor incrementation value. From version 4.00 emWin supports a new font type with this information. This also means that older font types can not be used to draw Thai text.

#### Note

The standard fonts of emWin do not contain font files with Thai characters. To create a Thai font file, the Font Converter of version 3.04 or newer is required.

#### Memory

The Thai language support does not need additional ROM nor RAM.

### 6.14.5.2 How to enable Thai support

Support of the Thai language has to be enabled by calling `GUI_UC_EnableThai()`.

### 6.14.5.3 Example

The `sample` folder contains the example `FONT_ThaiText.c`, which shows how to draw Thai text. It contains an emWin font with Thai characters and some small Thai text examples.

### 6.14.5.4 Font files used with Thai text

Font files used to render Thai text need to include at least all characters defined in the Thai range `0xE00-0xE7F`.

## 6.14.6 Shift JIS support

Shift JIS (Japanese Industry Standard) is a character encoding method for the Japanese language. It is the most common Japanese encoding method. Shift JIS encoding makes generous use of 8-bit characters, and the value of the first byte is used to distinguish single- and multiple-byte characters.

The Shift JIS support of emWin is only needed if text with Shift JIS encoding needs to be rendered.

You need no special function calls to draw a Shift JIS string. The main requirement is a font file which contains the Shift JIS characters.

### 6.14.6.1 Creating Shift JIS fonts

The Font Converter can generate a Shift JIS font for emWin from any Windows font. When using a Shift JIS font, the functions used to display Shift JIS characters are linked automatically with the library.

Detailed information on how to create Shift-JIS fonts and implement them in a project can be found in the chapter *Font Converter* on page 3136.

## 6.14.7 Limitations

Currently emWin is not able to make text transitions required for drawing Devanagari and similar scripts. It does not contain an engine for complete complex script support. Because of this only RTF and Arabic transitions are supported.

## 6.15 Timing- and execution-related functions

Some widgets, as well as our demonstration code, require time-related functions. The other parts of the emWin graphic library do not require a time base.

The demonstration code makes heavy use of the routine `GUI_Delay()`, which delays for a given period of time. A unit of time is referred to as a tick.

### 6.15.1 Timing and execution API

The table below lists the available timing- and execution-related routines in alphabetical order. Detailed descriptions of the routines follow.

Routine	Description
<code>GUI_Delay()</code>	Delays for a specified period of time.
<code>GUI_Exec()</code>	Executes callback functions (typically redrawing of windows).
<code>GUI_Exec1()</code>	Executes a callback function (one job only; typically redrawing a window).
<code>GUI_GetTime()</code>	Returns the current system time.
<code>GUI_GetTimeSlice()</code>	Returns the currently set minimum time in milliseconds with which a <code>GUI_X_Delay()</code> will get called within <code>GUI_Delay()</code> .
<code>GUI_SetTimeSlice()</code>	Sets the minimum time with which a <code>GUI_X_Delay()</code> gets called within <code>GUI_Delay()</code> .

### 6.15.1.1 GUI\_Delay()

#### Description

Delays for a specified period of time.

#### Prototype

```
void GUI_Delay(int Period);
```

#### Parameters

Parameter	Description
<code>Period</code>	Minimum period in ticks until function should return.

#### Additional information

The time unit (tick) is usually milliseconds (depending on `GUI_X_` functions). `GUI_Delay()` only executes idle functions for the given period. If the Window Manager is used, the delay time is used for the updating of invalid windows (through execution of `WM_Exec()`). Please note that the given period is a minimum period. Larger drawing operations of the WM for example could take more time than the given period. This function will call `GUI_X_Delay()`.



### 6.15.1.2 GUI\_Exec()

#### Description

Executes callback functions (typically redrawing of windows).

#### Prototype

```
int GUI_Exec(void);
```

#### Return value

- 0 if there were no jobs performed.
- 1 if a job was performed.

#### Additional information

This function will automatically call `GUI_Exec1()` repeatedly until it has completed all jobs—essentially until a 0 value is returned. Normally this function does not need to be called by the user application. It is called automatically by `GUI_Delay()`.

### 6.15.1.3 GUI\_Exec1()

#### Description

Executes a callback function (one job only; typically redrawing a window).

#### Prototype

```
int GUI_Exec1(void);
```

#### Return value

- 0 if there were no jobs performed.
- 1 if a job was performed.

#### Additional information

This routine may be called repeatedly until 0 is returned, which means all jobs have been completed. This function is called automatically by `GUI_Exec()`.

### 6.15.1.4 GUI\_GetTime()

#### Description

Returns the current system time.

#### Prototype

```
GUI_TIMER_TIME GUI_GetTime(void);
```

#### Return value

The current system time in ticks.

#### Additional information

This function calls `GUI_X_GetTime()`. `GUI_TIMER_TIME` is explained under `GUI_TIMER_TIME`.

### 6.15.1.5 GUI\_GetTimeSlice()

#### Description

Returns the currently set minimum time in milliseconds with which a `GUI_X_Delay()` will get called within `GUI_Delay()`.

#### Prototype

```
int GUI_GetTimeSlice(void);
```

#### Return value

Value set as time slice in ms.

#### Additional information

Prior to version 5.38 of emWin the minimum time a `GUI_Delay()` took was 5ms. With the function `GUI_SetTimeSlice()` the minimum time can be set.

### 6.15.1.6 GUI\_SetTimeSlice()

#### Description

Sets the minimum time with which a `GUI_X_Delay()` gets called within `GUI_Delay()`.

#### Prototype

```
void GUI_SetTimeSlice(int TimeSlice);
```

#### Parameters

Parameter	Description
<code>TimeSlice</code>	Minimum time to be used within a <code>GUI_Delay()</code> .

#### Additional information

The default value for the minimum time is 5ms.

## 6.15.2 Verbosity API

The table below lists the available verbosity related routines in alphabetical order. Detailed descriptions of the routines follow.

<b>Routine</b>	<b>Description</b>
<a href="#">GUI_ErrorOut()</a>	Shows a message box with an error and stops execution.
<a href="#">GUI_Log()</a>	Prints out logging messages.
<a href="#">GUI_Warn()</a>	Prints out warning messages.

### 6.15.2.1 GUI\_ErrorOut()

#### Description

Shows a message box with an error and stops execution. This function is called by emWin in case of serious errors which causes the system to stop execution. A pointer to a string is passed which contains a short error description. The error message contains the module and function where the error occurred and a short description. The simulation automatically shows a message box with the error message in debug mode. To be able to intercept these major errors on the target system, the function `GUI_SetOnErrorFunc()` can be used to set up a custom routine which is called by `GUI_ErrorOut()`.

#### Prototype

```
void GUI_ErrorOut(const char * s);
```

#### Parameters

Parameter	Description
s	Error string which is passed on to the function <code>GUI_X_ErrorOut()</code> and to the user defined error handling function.

#### Additional information

Detailed information on how to set up a user defined error handling function can be found in the description of the function `GUI_SetOnErrorFunc()` in the chapter *Configuration* on page 109.

## 6.15.2.2 GUI\_Log()

### Description

Prints out logging messages. Logging messages printed for example when memory for handles is allocated or freed. A pointer to a string is passed which contains the logging message. It contains the module and function where the log message was sent and a short description. To be able to intercept these loggings on the target system, the function `GUI_SetOnLogFunc()` can be used to set up a custom routine which is called by `GUI_Log()`.

### Prototype

```
void GUI_Log(const char * s);
```

### Parameters

Parameter	Description
<code>s</code>	Error string which is passed on to the function <code>GUI_X_Log()</code> and to the user defined error handling function.

### Additional information

Detailed information on how to set up a user defined logging handling function can be found in the description of the function `GUI_SetOnLogFunc()` in the chapter *Configuration* on page 109.



### 6.15.2.3 GUI\_Warn()

#### Description

Prints out warning messages. For example when false parameters have been passed to a function, a warning will be printed with this function. A pointer to a string is passed which contains a short warning. The string contains the module and function where the warning occurred and a short description. To be able to intercept these warnings on the target system, the function `GUI_SetOnWarnFunc()` can be used to set up a custom routine which is called by `GUI_Warn()`.

#### Prototype

```
void GUI_Warn(const char * s);
```

#### Parameters

Parameter	Description
<code>s</code>	Error string which is passed on to the function <code>GUI_X_Warn()</code> and to the user defined warning handling function.

#### Additional information

Detailed information on how to set up a user defined error handling function can be found in the description of the function `GUI_SetOnErrorFunc()` in the chapter *Configuration* on page 109.

### 6.15.3 Timer API

The table below lists the available timer-related routines in alphabetical order. Detailed descriptions of the routines follow.

<b>Routine</b>	<b>Description</b>
<a href="#">GUI_TIMER_Create()</a>	Creates a timer.
<a href="#">GUI_TIMER_Delete()</a>	Deletes the given timer.
<a href="#">GUI_TIMER_Restart()</a>	Restarts the given timer.
<a href="#">GUI_TIMER_SetPeriod()</a>	Sets the timer period.

### 6.15.3.1 GUI\_TIMER\_Create()

#### Description

Creates a timer. When the timer expires the timer callback function is called.

#### Prototype

```
GUI_TIMER_HANDLE GUI_TIMER_Create(GUI_TIMER_CALLBACK * cb,
                                  GUI_TIMER_TIME      Time,
                                  PTR_ADDR            Context,
                                  U16                 Flags);
```

#### Parameters

Parameter	Description
<code>cb</code>	Pointer to the user defined timer callback function which is called when the timer expires. Prototype is shown below.
<code>Time</code>	Destination time. The created timer expires when the system time exceeds this value.
<code>Context</code>	Timer context which is returned unchanged via timer callback function.
<code>Flags</code>	Not used. Reserved for future use.

#### GUI\_TIMER\_CALLBACK

```
typedef void GUI_TIMER_CALLBACK(GUI_TIMER_MESSAGE * pTM);
```

Parameter	Description
<code>pTM</code>	Pointer to a <code>GUI_TIMER_MESSAGE</code> structure which is explained below. Changes which are done from within the callback function are not applied. In order to have another context, a new timer should be created.

#### Elements of structure GUI\_TIMER\_MESSAGE

Data type	Element	Description
<code>GUI_TIMER_TIME</code>	<code>Time</code>	Contains the time value when the timer expired.
<code>U32</code>	<code>Context</code>	User defined context value which was specified at creation of the timer.
<code>GUI_TIMER_HANDLE</code>	<code>hTimer</code>	Handle of the expired timer.

#### GUI\_TIMER\_TIME

This define can be set to the desired type in the file `GUIConf.h`. The default type is `int`.

#### Note

The data type must be signed.

#### Return value

Handle to the created timer. 0, if no timer was created.

#### Additional information

Timers are not deleted automatically. To delete a timer the function `GUI_TIMER_Delete()` can be used. Restarting a timer can be achieved with `GUI_TIMER_Restart()`.

### 6.15.3.2 GUI\_TIMER\_Delete()

#### Description

Deletes the given timer.

#### Prototype

```
void GUI_TIMER_Delete(GUI_TIMER_HANDLE hObj);
```

#### Parameters

Parameter	Description
<code>hObj</code>	Timer handle.

#### Return value

Handle to the created timer. 0, if no timer was created.

#### Additional information

Timers are deleted immediately. After deleting a timer the according callback function will not be triggered.

### 6.15.3.3 GUI\_TIMER\_Restart()

#### Description

Restarts the given timer.

#### Prototype

```
void GUI_TIMER_Restart(GUI_TIMER_HANDLE hObj);
```

#### Parameters

Parameter	Description
<code>hObj</code>	Timer handle.

### 6.15.3.4 GUI\_TIMER\_SetPeriod()

#### Description

Sets the timer period. The period defines the time which has to pass until the callback function is triggered again.

#### Prototype

```
void GUI_TIMER_SetPeriod(GUI_TIMER_HANDLE hObj,  
                        GUI_TIMER_TIME  Period);
```

#### Parameters

Parameter	Description
<a href="#">hObj</a>	Timer handle.
<a href="#">Period</a>	Timer period.

#### Additional information

This period is used only when the timer is restarted.

# Chapter 7

## Advanced features

---

The following chapter contains all advanced emWin features. Some of these features are part of the **emWin PRO package** and they all can be purchased separately.

- The Window Manager (WM)
- Widgets (window objects)
- Dialogs
- Skinning
- Anti-aliasing
- Memory Devices
- MultiTouch support (MT)
- VNC Server

## 7.1 The Window Manager (WM)

When using the emWin Window Manager (WM), everything which appears on the display is contained in a window—a rectangular area on the screen. A window can be of any size, and you can display multiple windows on the screen at once, even partially or entirely in front of other windows.

The Window Manager supplies a set of routines which allow you to easily create, move, resize, and otherwise manipulate any number of windows. It also provides lower-level support by managing the layering of windows on the display and by alerting your application to display changes that affect its windows.

The emWin Window Manager is a separate (optional) software item and is not included in the emWin basic package. The software for the Window Manager is located in the subdirectory `GUI\WM`.

### 7.1.1 Description of terms

Windows are rectangular in shape, defined by their origin (the X- and Y-coordinates of the upper left corner) as well as their X- and Y-sizes (width and height, respectively). A window in emWin:

- is rectangular.
- has a Z-position.
- may be hidden or shown.
- may have valid and/or invalid areas.
- may or may not have transparency.
- may or may not have a callback routine.

#### Active window

The window which is currently being used for drawing operations is referred to as the active window. It is not necessarily the same as the topmost window.

#### Callback routines

Callback routines are defined by the user program, instructing the graphic system to call a specific function when a specific event occurs. Normally they are used to automatically redraw a window when its content has changed.

#### Child windows

A child window is one that is defined relative to another window, called the parent. Whenever a parent window moves, its child or children move correspondingly. A child window is always completely contained within its parent, and will be clipped if necessary. Multiple child windows with the same parent are considered "siblings" to one another.

#### Client area

The client area of a window is simply its usable area. If a window contains a frame or title bar, then the client area is the rectangular inner area. If there is no such frame, then the coordinates of the client area are identical to those of the window itself.

#### Clipping, clip area

Clipping is the process of limiting output to a window or part of it. The clip area of a window is its visible area. This is the window area minus the area obstructed by siblings of higher Z-order, minus any part that does not fit into the visible area of the parent window.

#### Coordinates

Coordinates are usually 2 dimensional coordinates, expressed in units of pixels. A coordinate consists of 2 values. The first value specifies the horizontal component (also called the x-coordinate), the second value specifies the vertical component (also called the y-coordinate).



## Current window

See active window.

## Desktop coordinates

Desktop coordinates are coordinates of the desktop window. The upper left position (the origin) of the display is (0,0).

## Desktop window

The desktop window is automatically created by the Window Manager, and always covers the entire display area. This is done for each layer, so each layer has its own desktop window. The desktop is always the bottommost window, and when no other window has been defined, it is the default (active) window. All windows are descendants (children, grandchildren, etc.) of the desktop window of the currently selected layer. The desktop window has a buffer which can hold data with the size of a void data type. This allows the user to add user data, e.g. a pointer to a structure.

## Early clipping

This is the default clipping mode. In this mode clipping is performed before windows receive paint events. In case the current window needs to be clipped, it will receive more than one `WM_PAINT` message within a single drawing process.

In the late clipping mode, windows always receive only one single `WM_PAINT` message. In this mode clipping is performed within the drawing operations.

## Handle

When a new window is created, the WM assigns it a unique identifier called a handle. The handle is used in any further operations performed on that particular window.

## Hiding windows

A hidden window is not visible, although it still exists (has a handle). When a window is created, it is hidden by default if no create flag is specified. Showing a window makes it visible; hiding it makes it invisible.

## Late clipping

See early clipping.

## Parent coordinates

Parent coordinates are window coordinates relative to the parent window. The upper left position (the origin) of the window is (0,0).

## Parent windows

See child windows.

## Showing windows

See Hiding windows.

## Siblings

See child windows.

## Transparency

A window that has transparency contains areas that are not redrawn with the rest of the window. These areas operate as though the window behind "shows through" them. In this case, it is important that the window behind is redrawn before the window with transparency. The WM automatically handles redrawing in the correct order.

### **Validation/invalidation**

A valid window is a fully updated window which does not need redrawing. An invalid window does not yet reflect all updates and therefore needs to be redrawn, either completely or partially. When changes are made that affect a particular window, the WM marks that window as invalid. The next time the window is redrawn (either manually or by a callback routine) it will be validated.

### **Window coordinates**

Window coordinates are coordinates of a window. The upper left position (the origin) of the window is (0,0).

### **Z-position, bottom/top**

Although a window is displayed on a two-dimensional screen in terms of X and Y, the WM also manages what is known as a Z-position, or depth coordinate—a position in a virtual third dimension which determines its placement from background to foreground. Windows can therefore appear on top of or beneath one another.

Setting a window to the bottom will place it “underneath” all of its sibling windows (if any); setting it to the top will place it “on top of” its siblings. When a window is created, it is set to the top by default if no create flag is specified.

## 7.1.2 Callback mechanism, invalidation, rendering and keyboard input

The idea behind the callback mechanism that emWin offers for windows and window objects (widgets) is that of an event-driven system. As in most windowing systems, the principle is that the flow of control is not just from the user program to the graphic system, but also from the user program to the graphic system and back up to the user program by means of the callback routines provided by the user program. This mechanism—often facetiously referred to as the Hollywood principle (“Don’t call us, we’ll call you!”)—is needed by the Window Manager mainly in order to trigger the redrawing of windows. This contrasts with classical programming, but it makes it possible to exploit the invalidation logic of the Window Manager.

### 7.1.2.1 Rendering using callbacks

In order to create a window with a callback, you must have a callback routine. The routine is used as part of the `WM_CreateWindow()` function when creating the window (the `cb` parameter). All callback routines must have the following prototype:

#### Prototype

```
void Callback(WM_MESSAGE * pMsg);
```

Parameter	Description
<code>pMsg</code>	Pointer to a data structure of type <code>WM_MESSAGE</code> .

The action performed by the callback routine depends on the type of message it receives. The prototype above is usually followed by a switch statement, which defines different behaviors for different messages using one or more case statements (typically at least `WM_PAINT`).

#### Processing the `WM_PAINT` message

When a window receives a `WM_PAINT` message, it should repaint itself. Before sending this message to the window, the WM makes sure it is selected. **A non-transparent window (default!) has to repaint its entire invalid area.** The easiest way is to repaint the entire area of the window. The clipping mechanism of the WM makes sure that only the invalid area will be redrawn. In order to accelerate the drawing process, it can make sense to only repaint the invalid area. How to get the invalid area is described later in this chapter (Information is part of the message).

**A transparent window** on the other hand does not have to redraw the entire invalid area; it can leave the window area partially untouched. This untouched area will then be transparent.

Before the WM sends a `WM_PAINT` message to a transparent window, the area below has been redrawn (by sending a `WM_PAINT` message to the window(s) below).

#### Note

Do not draw outside of `WM_PAINT`!

The messages `WM_PAINT`, `WM_PRE_PAINT` and `WM_POST_PAINT` should only process drawing operations.

Of course, this rule only **not** apply when another drawing device other than the driver is currently selected, e.g. a memory device or a dirty device.

When processing the `WM_PAINT` message, the callback routine should do nothing but redrawing the contents of the window. When processing the `WM_PAINT`, `WM_PRE_PAINT` or `WM_POST_PAINT` event, the following functions may not be called: `WM_SelectWindow()`,

`WM_Paint()`, `WM_DeleteWindow()` and `WM_CreateWindow()`. Also any other functions which changes the properties of a window may not be called: `WM_Move()`, `WM_Resize()`, ...

## Example

Creates a callback routine to automatically redraw a window:

```
void WinHandler(WM_MESSAGE * pMsg) {
    switch (pMsg->MsgId) {
        case WM_PAINT:
            GUI_SetBkColor(0xFF00);
            GUI_Clear();
            GUI_DispStringAt("Hello world",0,0);
            break;
        default:
            WM_DefaultProc(pMsg);
    }
}
```

The messages `WM_PRE_PAINT` and `WM_POST_PAINT` are sent directly before and after the `WM_PAINT` messages are processed.

### 7.1.2.2 Overwriting callback functions

The default behavior of widgets and windows in emWin is defined in their callback functions. If the behavior of a widget has to be changed, or if the functionality of a window needs to be enhanced to meet custom needs, it is recommended to overwrite the internal callback function. This is done in a few simple steps:

#### Step 1: Creating a custom callback function

The first step is to implement a function using the following prototype:

```
void Callback(WM_MESSAGE * pMsg);
```

#### Step 2: Messages

The second step is to implement a reaction to certain messages.

Since custom callback functions do not need to handle all possible messages, it is recommended to make use of a `switch / case` condition. This makes it possible to easily add or remove one message specific code, without affecting another. The parameter `pMsg` contains the Id of the message (`pMsg->MsgId`). A complete list of messages handled by the Window Manager may be reviewed under *Message IDs* on page 1137.

#### Step 3: Processing the default callback

The third step is to make sure all messages which are not handled by the custom callback function, are handled by the internal (default) callback function. The recommended way to do this is to use the default case of the `switch / case` condition to call the internal callback function.

Internal callback functions are different for each type of window. The internal callback functions for widgets are named `<WIDGET>_Callback()`. All other types of windows use the function `WM_DefaultProc()` for message handling.

```
switch (pMsg->MsgId) {
    case WM_CREATE:
        .
        .
        .
        break;
    case WM_PAINT:
        .
        .
        .
        break;
```

```
case WM_SIZE:
    .
    .
    .
    break;
default:
    <WIDGET>_Callback(pMsg);
}
```

#### Step 4: Setting the custom callback function to be used

The last step to do is setting the newly created callback function to be used by a window or widget. This is done with a simple call of `WM_SetCallback()`. Detailed information can be found under *WM\_SetCallback* on page 1064.

### 7.1.2.3 Background window redrawing and callback

During initialization of the Window Manager, a window containing the whole LCD area is created as a background window. The handle of this window is `WM_HBKWIN`. The WM does not redraw areas of the background window automatically, because there is no default background color. That means if you create a further window and then delete it, the deleted window will still be visible. The routine `WM_SetDesktopColor()` needs to be specified in order to set a color for redrawing the background window.

You can also set a callback function to take care of this problem. If a window is created and then deleted as before, the callback routine will trigger the WM to recognize that the background window is no longer valid and redraw it automatically. For more information on using a callback routine to redraw the background, see the example at the end of the chapter.

### 7.1.2.4 Invalidation

Invalidation of a window or a part of it tells the WM that the invalid area of the window should be redrawn the next time `GUI_Exec()` or `GUI_Delay()` is called. The invalidation routines of `emWin` do not redraw the invalid part of a window. They only manage the invalid areas of the windows.

#### The invalid area of a window

The WM uses just one rectangle per window to store the smallest rectangle containing the entire invalid area. If for example a small part in the upper left corner and a small part in the lower right corner becomes invalid, the complete window is invalidated.

#### Why using invalidation

The advantage of using window invalidation in opposite of drawing each window immediately is that the window will be drawn only one time even if it is invalidated more than one time. If for example several properties of a window need to be changed (for example the background color, the font and the size of the window) it takes more time to draw the window immediately after each property has been changed than drawing the window only one time after all properties have been changed.

#### Redrawing of invalid windows

The function `GUI_Exec()` redraws all invalid windows. This is done by sending one or more `WM_PAINT` messages to each invalid window.

### 7.1.2.5 Tiling mechanism

Until here it should be clear, that drawing of a window normally is done by sending a `WM_PAINT` message. But if a window is partly covered by a child window or any other window, it is very important to know that it receives more than one `WM_PAINT` message. The WM cuts the non covered area of the window to be drawn into a number of sub rectangles. During that process it sets the clipping area to each of the rectangular areas and sends a

single WM\_PAINT message for each of the rectangles to the window. The more fragmented the window area is, the more rectangles exist and the more messages are send. Because of that the WM\_PAINT handler should not do time consuming calculations.

The sample below shows the tiling mechanism required for drawing the background window covered by a FRAMEWINDOW widget. The widget consists of 2 windows, the main window and the client area. The main window is a transparent window which is drawn on top of the background and has no effect on the tiling algorithm whereas the client area is opaque and causes tiling of the background. The WM generates tiles around the client area from the top to the bottom and from the left to the right. The tiling algorithm implies that the number of tiles increases with the number of covered areas.

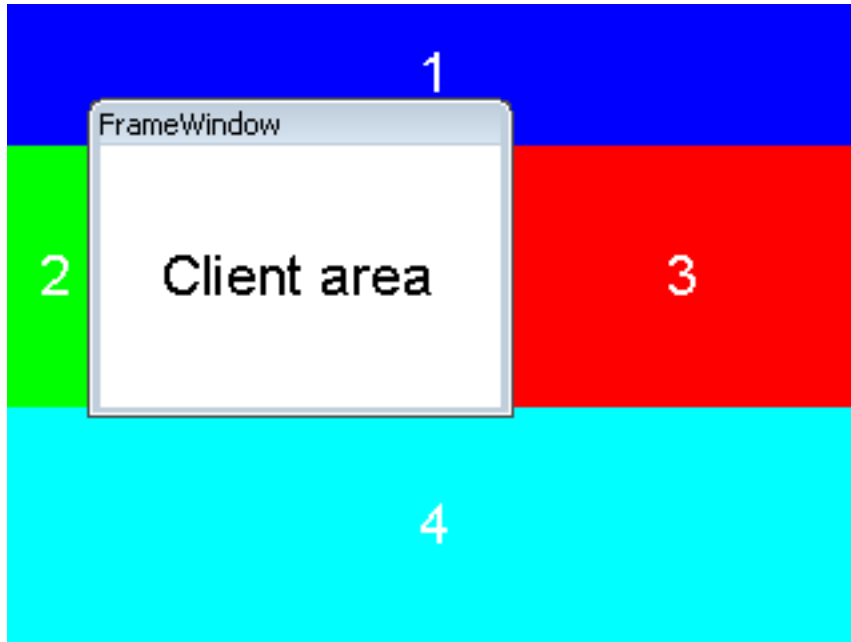

The screenshot below shows the above sample with an additional small window at the bottom right edge. When starting the drawing process of a non transparent window the WM first sends a WM\_PRE\_PAINT message. After that the window receives a WM\_PAINT message for each tile. And after drawing the last tile the WM sends a final WM\_POST\_PAINT message. The more areas covering a non transparent window the more tiles are required for drawing the window.



## Drawing without tiling

Under some circumstances it may could make sense to suppress tiling. That could be achieved by using the flag `WM_CF_LATE_CLIP` explained later in this chapter.

### 7.1.2.6 Rendering of transparent windows

If a transparent window needs to be drawn, the WM automatically makes sure, that the background of the window is drawn before the transparent window receives a `WM_PAINT` message. This is done by redrawing all window areas below the invalid area of the transparent window first before sending a `WM_PAINT` message to the transparent window.

To make sure the Window Manager can handle the redrawing of transparent windows it is necessary to redraw the window in reaction to the `WM_PAINT` message. Otherwise it can not be guaranteed that the appearance of a transparent window will be correctly.

The use of transparent windows is more CPU-intensive than the use of non transparent windows. If performance is a problem, trying to avoid transparent windows may be an option.

### 7.1.2.7 Automatic use of Memory Devices

The default behavior of the Window Manager is sending a `WM_PAINT` message to each window which needs to be redrawn. This can cause flickering effects. To suppress these 'per window' flickering effects Memory Devices can be used automatically for the drawing operation. This can be achieved by setting the flag `WM_CF_MEMDEV` when creating the window, by setting the default creation flags with `WM_SetCreateFlags()` or by using the function `WM_EnableMemdev()`. The WM then redirects the output of the `WM_PAINT` message into a Memory Device which is copied to the display once the actual drawing was performed. If not enough memory for the whole window is available banding is used automatically. The according Memory Device is created internally just before the `WM_PAINT` message is sent and is removed immediately after the drawing is finished.

In case a transparent window should be drawn, the below area will also be drawn into the Memory Device.

Detailed information about Memory Devices can be found in the chapter *Memory Devices* on page 2916.

### 7.1.2.8 Performance gain with Static Memory Devices

Similar to the flag `WM_CF_MEMDEV` the flag `WM_CF_STATIC` exists. Using this option for a window can be achieved by setting the flag `WM_CF_STATIC` when creating the window or by setting the default creation flags with `WM_SetCreateFlags()`. A detailed description of SMDs can be found in the chapter *Memory Devices* .

### 7.1.2.9 Automatic use of multiple frame buffers

The WM is able to use automatically multiple frame buffers if they are available. This can be achieved by the function `WM_MULTIBUF_Enable()`. If enabled the Window Manager redirects the output of all drawing functions to the invisible back buffer before it draws the invalid windows. After the last invalid window has been drawn the WM makes the back buffer visible. This feature is available only if the display driver supports multiple buffers and if there is enough RAM to store at least 2 frame buffers. More information can be found in the chapter *Multiple Buffering* on page 869.

### 7.1.2.10 Automatic use of display driver cache

The WM automatically uses the display driver cache if available. If available it locks the buffer before it starts to draw the invalid windows. After the last window has been drawn the WM unlocks the cache.

### 7.1.2.11 Keyboard input

The Window Manager handles keyboard input automatically. It polls the keyboard buffer and sends according keyboard messages to the currently focused window. The keyboard buffer can be filled using the function `GUI_StoreKeyMsg()`.



## 7.1.3 Motion support

Motion support enables the ability to move windows by gestures. It can be used with any pointer input device (PID) like a touch screen, a mouse or a joystick. If motion support is enabled the respective window can be put into movement simply with a gesture. After releasing the PID the movement is decelerated within a specified period. Movement operations can be also initiated by API functions instead of gestures.

### 7.1.3.1 Enabling motion support of the WM

First of all motion support needs to be enabled before it can be used. This can be done by calling the function `WM_MOTION_Enable()` once. Without calling this function once the motion support functions will not work.

### 7.1.3.2 Basic motion support for a window

To be able to use motion support for a window it needs to be enabled for each window which should be movable. In case of a movable parent window with several child windows motion support needs only be enabled for the parent window. There are 2 possibilities to achieve basic motion support for a window:

#### 7.1.3.2.1 Using creation flags

To achieve movability for a window it can be created with one or more or-combined creation flags. The following table shows the available creation flags:

Flag	Description
<code>WM_CF_MOTION_R</code>	Enables circular movability for objects within the window.
<code>WM_CF_MOTION_X</code>	Enables movability for the X axis.
<code>WM_CF_MOTION_Y</code>	Enables movability for the Y axis.

#### Example

```
WM_HWIN hWin;
hWin = WM_CreateWindowAsChild(0, 0, 40, 40, hParent,
    WM_CF_SHOW | WM_CF_MOTION_X | WM_CF_MOTION_Y, cbWin, 0);
```

#### Note

Of course the motion flags can also be used with widget creation functions.

#### 7.1.3.2.2 Using API function

To achieve movability for a window after it has been created without movability flags the function `WM_MOTION_SetMoveable()` explained later in this chapter can be used.

### 7.1.3.3 Motion processing by application

The easiest way to achieve movable windows is setting up basic motion support. The WM then automatically moves the window when dragging the PID. But in certain situations it could make sense to process the motion information by the application instead of moving the whole window. That makes it possible to move any kind of content within a window, achieving edge snapping, overlapping or circular moves. In order to make use of that kind of advanced motion features the callback function of the movable window has to be adapted. In case the WM recognizes PID movement it sends a `WM_MOTION` message to the window. In order to achieve advanced motion support an appropriate reaction to the `WM_MOTION` message needs to be implemented.

### 7.1.3.3.1 WM\_MOTION message and WM\_MOTION\_INFO

As explained in the message description *WM\_MOTION* on page 979 the *Data.p* element of the *WM\_MOTION* message points to a *WM\_MOTION\_INFO* structure. The element *Cmd* of this structure contains information about the current operation. The following table shows the possible values of the element *Cmd*:

Flag	Description
WM_MOTION_INIT	Sent to a window to initiate a motion operation.
WM_MOTION_MOVE	Sent to a window to achieve custom moving operations.
WM_MOTION_GETPOS	Sent to get the current position of custom moving operations.

#### WM\_MOTION\_INIT

If a PID move has been detected by the WM it first checks if there is any visible window available under the PID position which is already movable. This makes it possible to achieve moving operations for windows which are partially or totally covered by child windows. If the WM does not find an already movable window it sends the command to the 'top window' of the PID position.

If the window is not already movable when receiving this command the element *Flags* of the *WM\_MOTION\_INFO* structure can be used to enable motion support. The creation flags explained earlier can be used here to achieve automatic motion support. The *Flags* element simply needs to be OR-combined with the desired flag(s).

#### WM\_MOTION\_INIT and custom motion support

Custom motion support means that the moving operation is not done automatically by the WM but by the callback routine of the window. This can be useful if for example radial motions are required or if the content of a window should be moved instead of the window itself. To achieve custom motion support the *Flags* element needs to be OR-combined with the flag *WM\_MOTION\_MANAGE\_BY\_WINDOW*.

#### WM\_MOTION\_MOVE

Sent to a window with custom motion support enabled. The elements *dx* and *dy* of the *WM\_MOTION\_INFO* structure can be used to achieve the custom moving operation.

#### WM\_MOTION\_GETPOS

Sent to a window with custom motion support enabled. The task of the callback routine here is returning the current position. This needs to be done with the elements *xPos* and *yPos* of the *WM\_MOTION\_INFO* structure.

#### Snapping

The elements *SnapX* and *SnapY* of the *WM\_MOTION\_INFO* structure can be used to achieve snapping. These values determine a kind of grid for snapping. This means that the deceleration of the movement operation will stop exactly on a grid position. Also if there currently is no movement and the window is only released it will snap into the next grid position.

#### Overlapping

Overlapping means a short distance a window/object could be moved beyond its boundary. When releasing the PID it will move to its boundary automatically. The element *Overlap* of the *WM\_MOTION\_INFO* structure can be used to achieve overlapping. It is recommended to use at maximum the half of the snapping distance.

#### Examples

Several samples in the tutorial folder show how to achieve overlapping, snapping, circular moves and how to use advanced motion support.

### 7.1.3.4 Motion support for circular moves

That kind of motion support can be used to turn items around the center of a window. Windows can not be rotated. To enable support for circular moves the flag `WM_CF_MOTION_R` should be used which should be set within the `WM_MOTION_INIT` message. Moving the items need to be managed by the application. Because of that also the flag `WM_MOTION_MANAGE_BY_WINDOW` explained earlier must be set. The values in 1/10 degrees to be used are passed to the application in the element `da` of the `WM_MOTION_INFO` structure available within the message `WM_MOTION_MOVE`. The KNOB widget for example is completely based on motion support for circular moves.

#### Example

```
static void _OnMotion(WM_HWIN hWin, WM_MOTION_INFO * pInfo) {
    ...
    switch (pInfo->Cmd) {
    case WM_MOTION_INIT:
        pInfo->Flags = WM_CF_MOTION_R | WM_MOTION_MANAGE_BY_WINDOW;
        break;
    case WM_MOTION_MOVE:
        _DoMotion(hObj, pInfo->da);
        break;
    ...
    }
}
```

### 7.1.3.5 Widgets with motion support

Some of the widgets provide motion support which can be enabled by calling `<WIDGET>_EnableMotion()`.

If needed, an overlapping value in pixels can also be set by calling `<WIDGET>_SetOverlap()`. The overlapping value is the distance in pixels that the user can drag the content above the start and end position.

Widget	Routine
<code>&lt;WIDGET&gt;_EnableMotion()</code>	
DROPDOWN	<code>DROPDOWN_EnableMotion()</code>
LISTBOX	<code>LISTBOX_EnableMotion()</code>
LISTVIEW	<code>LISTVIEW_EnableMotion()</code>
MULTIEDIT	<code>MULTIEDIT_EnableMotion()</code>
SWIPELIST	<i>None, motion is always active.</i>
<code>&lt;WIDGET&gt;_SetOverlap()</code>	
LISTVIEW	<code>LISTVIEW_SetOverlap()</code>
SWIPELIST	<code>SWIPELIST_SetOverlap()</code>

## 7.1.4 Window manager and multiple layers

A hardware with multiple layers offers a range of new possibilities. This subchapter should give some guidelines and explain the most important pitfalls. We highly recommend to consider the following rules.

### 7.1.4.1 Drawing operations

One of the most important recommendations is using the invalidation mechanism of the window manager for drawing operations. If something should be drawn in a further layer a window with callback function should be used and the drawing operation should be done within `WM_PAINT`.

#### Note

Do **not** draw outside of a `WM_PAINT` message! It can lead to unexpected behavior.

On the first glance it often looks easy to use `GUI_SelectLayer()` and draw something outside of the current window in a different layer. But please note that this most often leads in unexpected behavior of the GUI. Multiple buffering, clipping and calculation of invalid state could fail in that case, even if it seems to work on the first glance.

### 7.1.4.2 Window relationship

A child window must be created in the same layer as its parent window. The WM won't work as expected if that rule is not observed. `WM_CreateWindow()` currently does not fail in that case, but the WM does not work correctly if the parent window is in a different layer than its child window.

### 7.1.4.3 Semi-transparency

Most LCD controllers with multiple layers support an alpha channel for semi transparency effects. That requires an alpha value in the alpha channel of the frame buffer after executing a drawing operation. Please note that the default behavior of `emWin` is using the given alpha values (for example of an PNG image) for mixing up the current background with the foreground and not leaving any alpha values. The function `GUI_PreserveTrans()` should be used before/after those drawing operations. The same applies for drawing anti-aliased text.

### 7.1.4.4 Touch input

Within a multiple layer application it could make sense to have touch sensitive widgets in more than one layer. But the touch pad does not 'know' something about different layers. The normal behavior is setting the element `Layer` of the `GUI_PID_STATE` structure within the touch ISR. The used value should be the layer index containing the touch sensitive widgets.

If it is required to manage touch input in different layers a callback function could be set with `GUI_PID_SetHook()`. That callback function is called immediately before a `GUI_PID_STATE` element is added to the input buffer. Dependent on the coordinates the application could change the `Layer` element. Please note that it is not required to change the coordinates. This is done by the WM automatically.

### 7.1.4.5 Memory devices

Currently a memory device which should be drawn in a `WM_PAINT` event, needs to be created in the same layer as the window which should draw the memory device.

## 7.1.5 ToolTips

A ToolTip in emWin is a small window with one line of text, which appears in conjunction with a pointer input device (PID), usually a mouse. The user hovers the PID over a 'tool', without clicking it, and a small ToolTip window with information about the item being hovered over may appear. After a short time the window disappears automatically. ToolTips make sense for active elements like any kind of button or similar widgets/windows, which can be used as tool for changing something. But they can be used with any kind of window.

### 7.1.5.1 How they work

A ToolTip belongs to a particular parent (or grandparent) window. When the PID hovers over a tool window without any motion, after a specified time (`PERIOD_FIRST`) the ToolTip window occurs. If the PID remains over the tool without motion, the ToolTip automatically disappears after a specified period of no motion (`PERIOD_SHOW`). It remains until the PID does not move for this period. If the PID is clicked or hovers out of the tool window the ToolTip disappears. If the PID remains in the parent area and the PID then hovers again over a tool of the same parent, the ToolTip occurs immediately after a very short period (`PERIOD_NEXT`) of no motion. If the PID moves out of the parent area, the next time a ToolTip occurs is again after `PERIOD_FIRST`. Appearance and timing can be configured at runtime.

### 7.1.5.2 Creating ToolTips

#### Note

The functions and structures mentioned in the following are described in detail later in this chapter under *ToolTip related functions* on page 1100.

The function `WM_TOOLTIP_Create()` should be used for creating a ToolTip object. It requires a handle to the parent (or grand parent) window. Optional a pointer to an array of `TOOLTIP_INFO` structures can be passed which is used for adding the desired tools to the ToolTip object. These structures should contain the IDs of the tools and the text to be shown. Alternatively the function `WM_TOOLTIP_AddTool()` can be used to add the tools. This makes sense if the tool window does not have an Id.

#### 7.1.5.2.1 Creating ToolTips for dialog items

As mentioned above the `TOOLTIP_INFO` structure is used to address the desired tools by its IDs. Because the items of a dialog normally have an Id this is quite easy.

#### Example

The following example shows how it works:

```
#include "DIALOG.h"
#define ID_BUTTON_0 (GUI_ID_USER + 0x01)
#define ID_BUTTON_1 (GUI_ID_USER + 0x02)
static const GUI_WIDGET_CREATE_INFO _aDialogCreate[] = {
    { FRAMEWIN_CreateIndirect, "Framewin", 0, 0, 0, 320, 240, 0, 0, 0 },
    { BUTTON_CreateIndirect, "Button 0", ID_BUTTON_0, 5, 5, 80, 20, 0, 0, 0 },
    { BUTTON_CreateIndirect, "Button 1", ID_BUTTON_1, 5, 30, 80, 20, 0, 0, 0 },
};
static const TOOLTIP_INFO _aInfo[] = {
    { ID_BUTTON_0, "I am Button 0" },
    { ID_BUTTON_1, "I am Button 1" },
};
static void _ShowDialog(void) {
    WM_HWIN hWin;
    WM_TOOLTIP_HANDLE hInfo;
    hWin = GUI_CreateDialogBox(_aDialogCreate, GUI_COUNTOF(_aDialogCreate), 0,
                              WM_HBKWIN, 0, 0);
    hInfo = WM_TOOLTIP_Create(hWin, _aInfo, GUI_COUNTOF(_aInfo));
}
```

```

while (1) {
    GUI_Delay(100);
}
}

```

### 7.1.5.2.2 Creating ToolTips for simple windows

Because simple windows normally do not have an Id, there exists a function for adding tools without using IDs. The function `WM_TOOLTIP_AddTool()` can be used to do this by passing the tool window handle and the required text to be shown.

#### Example

The following example shows how it works:

```

#include <stddef.h>
#include "WM.h"
static void _cbParent(WM_MESSAGE * pMsg) {
    switch (pMsg->MsgId) {
        case WM_PAINT:
            GUI_SetBkColor(GUI_BLUE);
            GUI_Clear();
            GUI_DispString("Parent window");
            break;
    }
}
static void _cbTool(WM_MESSAGE * pMsg) {
    switch (pMsg->MsgId) {
        case WM_PAINT:
            GUI_SetBkColor(GUI_RED);
            GUI_Clear();
            GUI_DispString("Tool window");
            break;
    }
}
void MainTask(void) {
    WM_HWIN hTool, hParent;
    WM_TOOLTIP_HANDLE hToolTip;

    GUI_Init();
    WM_SetDesktopColor(GUI_BLACK);
    hParent = WM_CreateWindow(0, 0, 200, 100, WM_CF_SHOW, _cbParent, 0);
    hTool
    = WM_CreateWindowAsChild(20, 20, 100, 50, hParent, WM_CF_SHOW, _cbTool, 0);
    hToolTip = WM_TOOLTIP_Create(hParent, NULL, 0);
    WM_TOOLTIP_AddTool(hToolTip, hTool, "I am a ToolTip");
    while (1) {
        GUI_Delay(100);
    }
}

```

## 7.1.6 Messages

The following section shows which system messages are used by emWin, how to use the message data and how to use application defined messages.

### 7.1.6.1 Message structure

When a callback routine is called, it receives the message specified as its `pMsg` parameter. This message is actually a `WM_MESSAGE` data structure, a full description of the structure can be read under `WM_MESSAGE` on page 1132.

### 7.1.6.2 List of messages

#### Note

A full list of messages sent by emWin can be found under *Message IDs* on page 1137.

### 7.1.6.3 System-defined messages

These kind of messages are sent by the GUI library. Do not send system defined messages from the user application to a window or a widget.

#### 7.1.6.3.1 WM\_CREATE

##### Description

This message is sent immediately after a window has been created, giving the window the chance to initialize and create any child windows.

##### Data

This message contains no data.

#### 7.1.6.3.2 WM\_DELETE

##### Description

This message is sent just before a window is deleted, telling the window to free its data structures (if any).

##### Data

This message contains no data.

#### 7.1.6.3.3 WM\_GET\_ID

##### Description

This message is sent to a window to request its Id. All emWin widgets handle this message. Application defined windows should handle this message in their callback routine. Otherwise this message will be ignored.

##### Data

The callback routine of the window should store the Id in the `Data.v` value.

#### 7.1.6.3.4 WM\_GET\_INSIDE\_RECT

##### Description

This message is sent to a window to receive the client rectangle without the effect size. The effect size which is typically 0-3 pixels (2 pixels with the standard 3D effect).

## Data

The `Data.p` pointer of the messages points to a `GUI_RECT` structure which has to be filled with the proper coordinates of the client rectangle.

### 7.1.6.3.5 WM\_INIT\_DIALOG

#### Description

This message is sent to a window immediately after the creation of the dialog and before the dialog is displayed. Dialog procedures typically use this message to initialize widgets and carry out any other initialization tasks that affect the appearance of the dialog box.

#### Data

This message contains no data.

### 7.1.6.3.6 WM\_KEY

#### Description

Sent to the window currently containing the focus if a key has been pressed.

#### Data

The `Data.p` pointer of the message points to a `WM_KEY_INFO` structure.

### 7.1.6.3.7 WM\_MOVE

#### Description

This message is sent to a window immediately after it has been moved. If the window has any child windows, they will be moved first. Also each child window will receive this message after it has been moved. The message is sent regardless if the window is visible or not.

#### Data

The `Data.p` pointer of the message points to a `WM_MOVE_INFO` structure.

### 7.1.6.3.8 WM\_NOTIFY\_PARENT

#### Description

Notifies a parent window that something has occurred in one of its child windows. These messages are typically sent by widgets to their parent windows to give them a chance to react on the event.

#### Data

The `Data.v` value of the message contains the notification code of the message. For more information about the notification codes, refer to the appropriate widget.

### 7.1.6.3.9 WM\_NOTIFY\_VIS\_CHANGED

#### Description

This message is sent to a window if its visibility is changed and the configuration switch `WM_SUPPORT_NOTIFY_VIS_CHANGED` is set to 1. The visibility of a window changes if

- obstruction changes: The window is partially or totally covered or uncovered by a higher level window (a window which is displayed on top of the window),
- the window is deleted or
- the window changes from not hidden to hidden or reverse.



## Typical application

Applications which show a video in a window using a hardware decoder. The hardware decoder can write directly into the display, bypassing emWin, if the window containing the video is completely visible. If the visibility changes, the hardware decoder needs to be reprogrammed.

## Example

The following shows a typical reaction on this message:

```
case WM_NOTIFY_VIS_CHANGED:
    if (WM_IsCompletelyVisible(WM_GetClientWindow(pMsg->hWin))) {
        ...
    }
```

The `Sample` folder of emWin contains the example `WM_Video.c` which shows how to use the message.

## Data

This message contains no data.

### 7.1.6.3.10 WM\_PAINT

#### Description

The WM sends this message to a window if it has become invalid (partially or complete) and needs to be drawn. When a window receives a `WM_PAINT` message, it should repaint itself. Before sending this message to the window, the WM makes sure it is selected. More details about how to react on the `WM_PAINT` message is described earlier in this chapter under *Callback mechanism, invalidation, rendering and keyboard input* on page 963.

#### Data

The `Data.p` pointer of the message points to a `GUI_RECT` structure containing the invalid rectangle of the window in screen coordinates. This information could be used to optimize the paint function.

### 7.1.6.3.11 WM\_POST\_PAINT

#### Description

The WM sends this message to a window right after the last `WM_PAINT` message was processed.

#### Data

This message contains no data.

### 7.1.6.3.12 WM\_PRE\_PAINT

#### Description

The WM sends this message to a window before the first `WM_PAINT` is sent.

#### Data

This message contains no data.

### 7.1.6.3.13 WM\_SET\_CALLBACK

#### Description

The WM sends this message to a window after a callback function has been set.

## Data

This message contains no data.

### 7.1.6.3.14 WM\_SET\_FOCUS

#### Description

Sent to a window if it gains or loses the input focus.

#### Data

If the window gains the input focus, the `Data.v` value is set to 1. If the window 'accepts' the input focus, it should set the `Data.v` value to 0 in reaction on this message. If the window loses the input focus, the `Data.v` value is set to 0.

### 7.1.6.3.15 WM\_SET\_ID

#### Description

Sent to a window to change the Id. All emWin widgets handle this message. Application defined windows should handle this message in their callback routine. Otherwise this message will be ignored.

#### Data

The `Data.v` value contains the new Id of the window.

### 7.1.6.3.16 WM\_SIZE

#### Description

Sent to a window after its size has changed. Gives the window the chance to reposition its child windows (if any).

#### Data

This message contains no data.

### 7.1.6.3.17 WM\_TIMER

#### Description

This message will be sent to a window when a timer created by `WM_CreateTimer()` has expired.

#### Data

The `Data.v` value contains the handle of the expired timer.

### 7.1.6.3.18 WM\_USER\_DATA

#### Description

Sent to a window immediately after `WM_SetUserData()` has been called.

## 7.1.6.4 Pointer input device (PID) messages

These kind of messages are sent by the GUI library in reaction of PID input. Do not send this messages from the user application to a window or a widget.

#### 7.1.6.4.1 WM\_MOTION

##### Description

A `WM_MOTION` message is sent to a window to achieve advanced motion support. It is sent if a pointer input device is moved over a movable window and to initiate a moving operation. Detailed information about Motion Support can be found in the section *Motion support* on page 1092.

##### Data

The `Data.p` pointer of the message points to a `WM_MOTION_INFO` structure.

#### 7.1.6.4.2 WM\_MOUSEOVER

##### Description

A `WM_MOUSEOVER` message is sent to a window if a pointer input device touches the outline of a window. It is sent only if mouse support is enabled. This message is not sent to disabled windows.

To enable mouse support, add the following line to the file `GUIConf.h`:

```
#define GUI_SUPPORT_MOUSE 1
```

##### Data

The `Data.p` pointer of the message points to a `GUI_PID_STATE` structure. The structure member `Pressed` is always set to 0 when receiving a `WM_MOUSEOVER` message.

#### 7.1.6.4.3 WM\_MOUSEOVER\_END

##### Description

A `WM_MOUSEOVER_END` message is sent to a window if the mouse pointer has been moved out of the window. It is sent only if mouse support is enabled. This message is not sent to disabled windows.

##### Data

The `Data.p` pointer of the message points to a `GUI_PID_STATE` structure. For details about this structure, refer to the message `WM_MOUSEOVER`.

#### 7.1.6.4.4 WM\_PID\_STATE\_CHANGED

##### Description

Sent to the window affected by the pointer input device when the pressed state has changed. The affected window is the visible window at the input position. With other words: If the user releases for example the touch screen over a window, the pressed state changes from 1 (pressed) to 0 (unpressed). In this case a `WM_PID_STATE_CHANGED` message is sent to the window. This message is sent before the touch message is sent. An invisible window does not receive this message. Transparent windows are handled the same way as visible windows. This message is not sent to disabled windows.

##### Data

The `Data.p` pointer of the message points to a `WM_PID_STATE_CHANGED_INFO` structure.

#### 7.1.6.4.5 WM\_TOUCH

##### Description

A `WM_TOUCH` message is sent to a window once the PID

- is pressed.

- is moved in pressed state.
- is released.

Windows receive this message, if one of the actions above happens over the visible area and if they are not disabled.

If a window should not receive touch messages the create flag `WM_CF_UNTOUCHABLE` can be used. This causes the touch input to be routed to its parent window.

**Data**

The `Data.p` pointer of the message points to a `GUI_PID_STATE` structure. `Data.p = NULL` means that the PID was moved out of bounds in pressed state.

**7.1.6.4.6 WM\_TOUCH\_CHILD**

**Description**

This message is sent to the parent window if the outline of a child window has been touched with a pointer input device in pressed or unpressed state. This message is not sent to disabled windows.

**Data**

The `Data.p` pointer of the message points to the `WM_MESSAGE` sent to the child window. Details about the message data can be found under `WM_TOUCH` on page 979. The message has to be dereferenced twice to get access to the `GUI_PID_STATE` attached to this message.

**Example**

```
//                                     -> WM_TOUCH message           -> GUI_PID_STATE
pState = (GUI_PID_STATE *) ((WM_MESSAGE *) pMsg->Data.p)->Data.p;
```

**7.1.6.4.7 Example**

The following example explains what happens if a pointer input device is dragged over a dialog with a button:

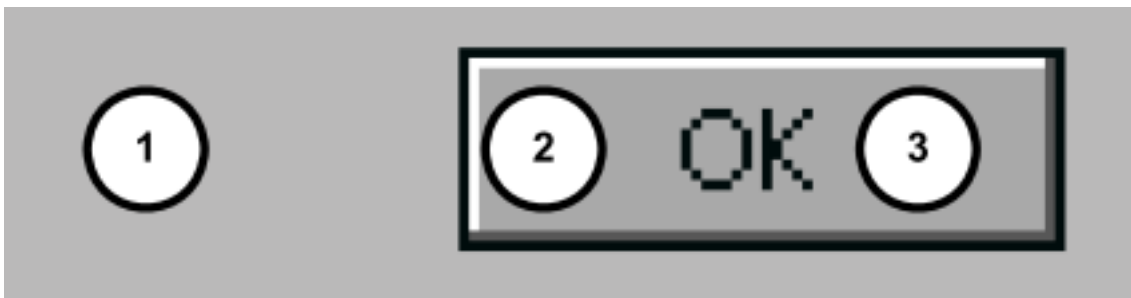

Position	Description
1	<p>The pointer input device (PID) is pressed at this position. This causes the WM to send the following <code>WM_PID_STATE_CHANGED</code> message to the window at this position:                      x = Horizontal position in desktop coordinates.                      y = Vertical position in desktop coordinates.                      State = 1                      StatePrev = 0</p> <p>The WM also sends a <code>WM_TOUCH</code> message with the same x and y coordinates to the window:                      x = Horizontal position in desktop coordinates.                      y = Vertical position in desktop coordinates.                      Pressed = 1</p>
2	<p>The PID is dragged to this position. The window below (the button) will receive no <code>WM_PID_STATE_CHANGED</code> message, because the PID remains in pressed state.                      The WM only sends a <code>WM_TOUCH</code> message to the window:                      x = Horizontal position in desktop coordinates.                      y = Vertical position in desktop coordinates.                      Pressed = 1</p>

Position	Description
3	<p>The PID is released at this position. This causes the WM to send the following <code>WM_PID_STATE_CHANGED</code> message to the window at this position:</p> <ul style="list-style-type: none"> <li>x = Horizontal position in desktop coordinates.</li> <li>y = Vertical position in desktop coordinates.</li> <li>State = 0</li> <li>StatePrev = 1</li> </ul> <p>The WM also sends a <code>WM_TOUCH</code> message with the same x and y coordinates to the window:</p> <ul style="list-style-type: none"> <li>x = Horizontal position in desktop coordinates.</li> <li>y = Vertical position in desktop coordinates.</li> <li>Pressed = 0</li> </ul>

### 7.1.6.5 System-defined notification codes

A message of this type is sent from a window to its parent window to notify it of a change in the child window. This gives the parent window the chance to react on this event. The message contains a `hWinSrc` element which is a handle to the widget which caused the message. Detailed information about which notification messages are utilized by a widget can be found in the according Widget description in the chapter *Widgets (window objects)* on page 1151.

#### Note

Do not send system defined notification codes from the user application to a window.

A full list of notification codes can be found under *Notification codes* on page 1142.

### 7.1.6.6 Application-defined messages

The application program can define additional messages for its own usage. In order to ensure that they custom message Ids do not equal the Ids which are predefined in `emWin`, user-defined messages start numbering at `WM_USER`. Defining custom messages is recommended as follows:

```
#define MY_MESSAGE_AAA (WM_USER + 0)
#define MY_MESSAGE_BBB (WM_USER + 1)
```

## 7.1.7 Configuration options

Type	Macro	Default	Description
B	WM_SUPPORT_NOTIFY_VIS_CHANGED	0	Enables the WM to send a WM_NOTIFY_VIS_CHANGED message to a window if its visibility is changed.
B	WM_SUPPORT_TRANSPARENCY	1	Enable support for transparent windows. If set to 0 the additional code for transparency support is not included.

### 7.1.7.1 WM\_SUPPORT\_NOTIFY\_VIS\_CHANGED

Per default emWin does not inform windows if their visibility has changed. If enabled, the WM sends WM\_NOTIFY\_VIS\_CHANGED messages.

### 7.1.7.2 WM\_SUPPORT\_TRANSPARENCY

Per default emWin supports transparent windows. This means per default the additional code used to handle transparent windows is linked if the WM is used. If the application does not use transparent windows the memory requirement of the application can be reduced if WM\_SUPPORT\_TRANSPARENCY is set to 0.

## 7.1.8 WM API

The following table lists the available routines of the emWin Window Manager API. All functions are listed in alphabetical order within their respective categories. Detailed descriptions of the routines can be found later in the chapter.

### Functions

Routine	Description
Basic functions	
<code>WM_Activate()</code>	Activates the Window Manager.
<code>WM_AttachWindow()</code>	Attaches a window to a new parent window.
<code>WM_AttachWindowAt()</code>	Attaches a window to a new parent window at the given position.
<code>WM_BroadcastMessage()</code>	Sends the given message to all existing windows.
<code>WM_BringToBottom()</code>	Places a specified window underneath its siblings.
<code>WM_BringToTop()</code>	Places a specified window on top of its siblings.
<code>WM_ClrHasTrans()</code>	Clears the <code>has transparency</code> flag (sets it to 0).
<code>WM_CreateWindow()</code>	Creates a window.
<code>WM_CreateWindowAsChild()</code>	Creates a window as a child window.
<code>WM_Deactivate()</code>	Deactivates the Window Manager.
<code>WM_DefaultProc()</code>	Default message handler.
<code>WM_DeleteWindow()</code>	Deletes a specified window.
<code>WM_DeleteWindowSecure()</code>	Deletes a window safely.
<code>WM_DetachWindow()</code>	Detaches a window from its parent window.
<code>WM_DisableWindow()</code>	Disables the specified window.
<code>WM_EnableWindow()</code>	Sets the specified window to enabled state.
<code>WM_Exec()</code>	Redraws invalid windows by executing callbacks (all jobs).
<code>WM_Exec1()</code>	Redraws one invalid window by executing one callback (one job only).
<code>WM_ForEachDesc()</code>	Iterates over all descendants of the given window.
<code>WM_GetActiveWindow()</code>	Returns handle of the active window.
<code>WM_GetCallback()</code>	Returns a pointer to the callback function of the given window.
<code>WM_GetCapture()</code>	Returns the window that currently has the capture.
<code>WM_GetChild()</code>	Returns the window handle of the requested child item (widget).
<code>WM_GetClientRect()</code>	Returns the coordinates of the client area in the active window in window coordinates.
<code>WM_GetClientRectEx()</code>	Returns the coordinates of the client area of a window in window coordinates.
<code>WM_GetDesktopWindow()</code>	Returns the handle of the desktop window.
<code>WM_GetDesktopWindowEx()</code>	Returns the window handle of the specified desktop window.
<code>WM_GetDialogItem()</code>	Returns the window handle of a dialog box item (widget).

Routine	Description
<code>WM_GetFirstChild()</code>	Returns the handle of a specified window's first child window.
<code>WM_GetFocusedWindow()</code>	Returns the handle of the window with the input focus.
<code>WM_GetHasTrans()</code>	Returns the current value of the has transparency flag.
<code>WM_GetInvalidRect()</code>	Returns the invalid rectangle of a window in desktop coordinates.
<code>WM_GetModalLayer()</code>	Returns the current modal layer.
<code>WM_GetModalWindow()</code>	Returns the modal window.
<code>WM_GetNextSibling()</code>	Returns the handle of a specified window's next sibling.
<code>WM_GetNumInvalidWindows()</code>	Returns the number of currently invalid windows.
<code>WM_GetOrgX()</code>	Returns the origin in X of the active window.
<code>WM_GetOrgY()</code>	Returns the origin in Y of the active window.
<code>WM_GetParent()</code>	Returns the handle of a specified window's parent window.
<code>WM_GetPrevSibling()</code>	Returns the handle of a specified window's previous sibling.
<code>WM_GetStayOnTop()</code>	Returns the current value of the stay on top flag.
<code>WM_GetUserData()</code>	Retrieves the data set with <code>WM_SetUserData()</code> .
<code>WM_GetWindowOrgX()</code>	Returns the origin in X of a window.
<code>WM_GetWindowOrgY()</code>	Returns the origin in Y of a window.
<code>WM_GetWindowRect()</code>	Returns the coordinates of the active window in desktop coordinates.
<code>WM_GetWindowRectEx()</code>	Returns the coordinates of a window in desktop coordinates.
<code>WM_GetWindowSizeX()</code>	Return the X-size of a specified window.
<code>WM_GetWindowSizeY()</code>	Return the Y-size of a specified window.
<code>WM_HasCaptured()</code>	Checks if the given window has captured PID input.
<code>WM_HasFocus()</code>	Checks if the given window has the input focus.
<code>WM_HideWindow()</code>	Makes a specified window invisible.
<code>WM_InvalidArea()</code>	Invalidates a certain section of the display.
<code>WM_InvalidRect()</code>	Invalidates a part of a window.
<code>WM_InvalidWindow()</code>	Invalidates a window.
<code>WM_IsCompletelyCovered()</code>	Checks if the given window is completely covered or not.
<code>WM_IsCompletelyVisible()</code>	Checks if the given window is completely visible or not.
<code>WM_IsEnabled()</code>	This function returns if a window is enabled or not.
<code>WM_IsUntouchable()</code>	Returns whether the given window has the un-touchable flag set.
<code>WM_IsVisible()</code>	Determines whether or not a specified window is visible.
<code>WM_IsWindow()</code>	Determines whether or not a specified handle is a valid window handle.



<b>Routine</b>	<b>Description</b>
<code>WM_MakeModal()</code>	This function makes the window work in 'modal' mode.
<code>WM_MoveChildTo()</code>	Sets the position of a window in window coordinates.
<code>WM_MoveTo()</code>	Sets the position of a window in desktop coordinates.
<code>WM_MoveWindow()</code>	Moves a window to another position.
<code>WM_NotifyParent()</code>	Sends a <code>WM_NOTIFY_PARENT</code> message to the given window.
<code>WM_Paint()</code>	Draws or redraws a specified window immediately.
<code>WM_PaintWindowAndDescs()</code>	Draws a given window and all descendant windows immediately.
<code>WM_ReleaseCapture()</code>	Releases capturing of mouse- and touch-screen-input.
<code>WM_ResizeWindow()</code>	Changes the size of a specified window by adding (or subtracting) the given differences.
<code>WM_Rect2Screen()</code>	Converts the given rectangle holding coordinates relative to the given window into screen positions.
<code>WM_Rect2Client()</code>	Converts the given rectangle holding coordinates relative to the screen into coordinates relative to the window.
<code>WM_Screen2hWin()</code>	Returns the window which lies at the specified position.
<code>WM_Screen2hWinEx()</code>	Returns the window which lies at the specified position.
<code>WM_SelectWindow()</code>	Selects a window to be used for drawing operations.
<code>WM_SendMessage()</code>	Sends a message to a specified window.
<code>WM_SendMessageNoPara()</code>	Sends a message without parameters to a specified window.
<code>WM_SendToParent()</code>	Sends the given message to the parent window of the given window.
<code>WM_SetCallback()</code>	Sets a callback routine to be executed by the Window Manager.
<code>WM_SetCapture()</code>	Routes all PID-messages to the given window.
<code>WM_SetCaptureMove()</code>	Moves a window according to the given PID state.
<code>WM_SetCreateFlags()</code>	Sets the flags to be used as default when creating a new window.
<code>WM_SetDesktopColor()</code>	Sets the color for the desktop window.
<code>WM_SetDesktopColorEx()</code>	Sets the color for the desktop window in a multi layer environment.
<code>WM_SetEnableState()</code>	Sets the window to an enabled or disabled state.
<code>WM_SetFocus()</code>	Sets the input focus to a specified window.
<code>WM_SetHasTrans()</code>	Enables transparency for the given window.
<code>WM_SetId()</code>	This function sends a <code>WM_SET_ID</code> message to the given window.

<b>Routine</b>	<b>Description</b>
<code>WM_SetModalLayer()</code>	Sets the layer to be used as modal layer.
<code>WM_SetpfPollPID()</code>	Sets a function to be called by the WM for polling the PID.
<code>WM_SetSize()</code>	Sets the new size of a window.
<code>WM_SetUntouchable()</code>	This function makes a window 'untouchable'.
<code>WM_SetWindowPos()</code>	Sets the size and the position of a window.
<code>WM_SetXSize()</code>	Sets the new X-size of a window.
<code>WM_SetYSize()</code>	Sets the new Y-size of a window.
<code>WM_SetStayOnTop()</code>	Sets the stay on top flag.
<code>WM_SetTransState()</code>	This function sets or clears the flags <code>WM_CF_HAS-TRANS</code> and <code>WM_CF_CONST_OUTLINE</code> of the given window.
<code>WM_SetUserClipRect()</code>	Reduces the clipping area temporarily.
<code>WM_SetUserData()</code>	Sets the extra data of a window.
<code>WM_ShowWindow()</code>	Makes a specified window visible.
<code>WM_Update()</code>	Draws the invalid part of the specified window immediately.
<code>WM_UpdateWindowAndDescs()</code>	Draws the invalid part of a given window and the invalid part of all descendant windows.
<code>WM_ValidateRect()</code>	Validates parts of a window.
<code>WM_ValidateWindow()</code>	Validates a window.
<code>WM_XY2Screen()</code>	Converts window coordinate into screen coordinates.
<code>WM_XY2Client()</code>	Converts screen coordinates into window coordinates.
<b>Motion support</b>	
<code>WM_MOTION_Enable()</code>	Enables motion support for the WM.
<code>WM_MOTION_SetDeceleration()</code>	Sets the deceleration for the current movement.
<code>WM_MOTION_SetDefaultPeriod()</code>	Sets the default period for movements.
<code>WM_MOTION_SetMotion()</code>	Sets speed and deceleration for the desired movement.
<code>WM_MOTION_SetMoveable()</code>	Sets movability flags for the given window.
<code>WM_MOTION_SetMovement()</code>	Sets speed and distance for the desired movement.
<code>WM_MOTION_SetSpeed()</code>	Sets the speed for the desired movement.
<code>WM_MOTION_SetThreshold()</code>	Sets the minimum distance required for starting a move.
<b>ToolTip related functions</b>	
<code>WM_TOOLTIP_AddTool()</code>	Adds a tool to an existing ToolTip object.
<code>WM_TOOLTIP_Create()</code>	Creates a ToolTip object for the given dialog.
<code>WM_TOOLTIP_Delete()</code>	Deletes the given ToolTip object.
<code>WM_TOOLTIP_SetDefaultColor()</code>	Sets the default colors to be used for drawing ToolTips.
<code>WM_TOOLTIP_SetDefaultFont()</code>	Sets the font to be used for displaying the text of ToolTips.
<code>WM_TOOLTIP_SetDefaultPeriod()</code>	Sets the default periods to be used for showing ToolTips.

Routine	Description
Multiple Buffering support	
<code>WM_MULTIBUF_Enable()</code>	This function enables or disables the automatic use of Multiple Buffering by the Window Manager.
Memory Device support (optional)	
<code>WM_DisableMemdev()</code>	Disables the use of Memory Devices for redrawing a window.
<code>WM_EnableMemdev()</code>	Enables the use of Memory Devices for redrawing a window.
Timer related	
<code>WM_CreateTimer()</code>	Creates a timer which sends a <code>WM_TIMER</code> message to a window.
<code>WM_DeleteTimer()</code>	Deletes the given timer.
<code>WM_GetTimerId()</code>	Gets the Id of the given timer.
<code>WM_RestartTimer()</code>	Restarts the given timer with the given period.
Widget related functions	
<code>WM_GetClientWindow()</code>	Returns the handle of the client window.
<code>WM_GetContentRect()</code>	Returns the content rectangle of the current window.
<code>WM_GetContentRectEx()</code>	Returns the content rectangle of a given window.
<code>WM_GetId()</code>	Returns the ID of a widget.
<code>WM_GetInsideRect()</code>	Returns the size of the active window less the border.
<code>WM_GetInsideRectEx()</code>	Returns the size of a window less the border.
<code>WM_GetScrollbarH()</code>	Returns the handle of an attached horizontal SCROLLBAR.
<code>WM_GetScrollbarV()</code>	Returns the handle of an attached vertical SCROLLBAR.
<code>WM_GetScrollerH()</code>	Returns the handle of an attached horizontal SCROLLER.
<code>WM_GetScrollerV()</code>	Returns the handle of an attached vertical SCROLLER.
<code>WM_GetScrollPartner()</code>	Returns the scroll partner of a given SCROLLBAR or SCROLLER handle.
<code>WM_GetScrollPosH()</code>	Returns the horizontal scroll position of a window.
<code>WM_GetScrollPosV()</code>	Returns the vertical scroll position of a window.
<code>WM_GetScrollState()</code>	Gets the state of a SCROLLBAR widget.
<code>WM_SetScrollPosH()</code>	Sets the horizontal scrolling position of a window.
<code>WM_SetScrollPosV()</code>	Sets the vertical scrolling position of a window.
<code>WM_SetScrollState()</code>	Sets the state of a specified SCROLLBAR widget.

## Data structures

Structure	Description
<code>TOOLTIP_INFO</code>	Contains the information about a ToolTip.
<code>WM_KEY_INFO</code>	Contains information about a pressed key.

Structure	Description
<a href="#">WM_MESSAGE</a>	Contains the data for a message sent by a window.
<a href="#">WM_MOTION_INFO</a>	Contains information about a move with motion support.
<a href="#">WM_MOVE_INFO</a>	Stores the distance of a window move operation.
<a href="#">WM_PID_STATE_CHANGED_INFO</a>	Information about the changed PID state.
<a href="#">WM_SCROLL_STATE</a>	Saves the scrollstate of a scrollbar.

## Defines

Group of defines	Description
<a href="#">Message IDs</a>	List of all messages sent by the Window Manager.
<a href="#">Motion flags</a>	Flags for motion support.
<a href="#">Motion messages</a>	Commands sent with a WM_MOTION message.
<a href="#">Notification codes</a>	List of all notification codes sent with WM_NOTIFY_PARENT.
<a href="#">ToolTip color indexes</a>	Color indexes for ToolTip related routines.
<a href="#">ToolTip period indexes</a>	Period indexes for ToolTip related routines.
<a href="#">Window create flags</a>	Flags that define a window upon creation.

### 7.1.8.1 Using the WM API functions

Many of the WM functions have window handles as parameters. Observe the following rules when using handles:

- Window handles can be 0. In this case functions usually return immediately. Functions which do not follow this rule are described accordingly.
- If a window handle is  $\neq 0$ , it should be a valid handle. The WM does not check if the given handle is valid. If an invalid handle is given to a function it fails or may even cause the application to crash.

## 7.1.8.2 Basic functions

### 7.1.8.2.1 WM\_Activate()

#### Description

Activates the Window Manager.

#### Prototype

```
void WM_Activate(void);
```

#### Additional information

The WM is activated by default after initialization. This function only needs to be called if there has been a previous call of `WM_Deactivate()`.

### 7.1.8.2.2 WM\_AttachWindow()

#### Description

The given window will be detached from its parent window and attached to the new parent window. The new origin in window coordinates of the new parent window will be the same as the old origin in window coordinates of the old parent window.

#### Prototype

```
void WM_AttachWindow(WM_HWIN hWin,  
                    WM_HWIN hParent);
```

#### Parameters

Parameter	Description
<code>hWin</code>	Window handle.
<code>hWinParent</code>	Window handle of the new parent.

#### Additional information

If the given window handle is 0 or both handles are the same the function returns immediately.

If only the given parent window handle is 0 the function detaches the given window and returns; the window remains unattached.

### 7.1.8.2.3 WM\_AttachWindowAt()

#### Description

The given window will be detached from its parent window and attached to the new parent window. The given position will be used to set the origin of the window in window coordinates of the parent window.

#### Prototype

```
void WM_AttachWindowAt(WM_HWIN hWin,  
                      WM_HWIN hParent,  
                      int      x,  
                      int      y);
```

#### Parameters

Parameter	Description
<code>hWin</code>	Window handle.
<code>hWinParent</code>	Window handle of the new parent.
<code>x</code>	X position of the window in window coordinates of the parent window.
<code>y</code>	Y position of the window in window coordinates of the parent window.

#### Additional information

If the given window handle is 0 or both handles are the same the function returns immediately.

If only the given parent window handle is 0 the function detaches the given window, moves it to the new position and returns; the window remains unattached.

#### 7.1.8.2.4 WM\_BringToBottom()

##### Description

Places a specified window underneath its siblings.

##### Prototype

```
void WM_BringToBottom(WM_HWIN hWin);
```

##### Parameters

Parameter	Description
<code>hWin</code>	Window handle.

##### Additional information

The window will be placed underneath all other sibling windows, but will remain in front of its parent.



### 7.1.8.2.5 WM\_BringToTop()

#### Description

Places a specified window on top of its siblings.

#### Prototype

```
void WM_BringToTop(WM_HWIN hWin);
```

#### Parameters

Parameter	Description
<code>hWin</code>	Window handle.

#### Additional information

The window will be placed on top of all other sibling windows and its parent.

### 7.1.8.2.6 WM\_BroadcastMessage()

#### Description

Sends the given message to all existing windows.

#### Prototype

```
int WM_BroadcastMessage(WM_MESSAGE * pMsg);
```

#### Parameters

Parameter	Description
<code>pMsg</code>	Pointer to the message structure to be sent.

#### Return value

Returns 0.

#### Additional information

A window should not delete itself or a parent window in reaction of a broadcasted message.

### 7.1.8.2.7 WM\_ClrHasTrans()

#### Description

Clears the `has transparency` flag (sets it to 0).

#### Prototype

```
void WM_ClrHasTrans(WM_HWIN hWin);
```

#### Parameters

Parameter	Description
<code>hWin</code>	Window handle.

#### Additional information

When set, this flag tells the Window Manager that a window contains sections which are not redrawn and will therefore be transparent. The WM then knows that the back-ground needs to be redrawn prior to redrawing the window in order to make sure the transparent sections are restored correctly.

When the flag is cleared with `WM_ClrHasTrans()`, the WM will not automatically redraw the background before redrawing the window.

### 7.1.8.2.8 WM\_CreateWindow()

#### Description

Creates a window of a specified size at a specified location.

#### Prototype

```
WM_HWIN WM_CreateWindow(int          x0,
                        int          y0,
                        int          width,
                        int          height,
                        U32          Style,
                        WM_CALLBACK * cb,
                        int          NumExtraBytes);
```

#### Parameters

Parameter	Description
<code>x0</code>	Upper left X-position in desktop coordinates.
<code>y0</code>	Upper left Y-position in desktop coordinates.
<code>width</code>	X-size of window.
<code>height</code>	Y-size of window.
<code>Style</code>	Window create flags which are OR-combinable. See a full list under <i>Window create flags</i> on page 1146.
<code>cb</code>	Pointer to callback routine, or NULL if no callback used.
<code>NumExtraBytes</code>	Number of extra bytes to be allocated, normally 0.

#### Return value

Handle to the created window.

#### Additional information

Several create flags can be combined by using the OR operator. Negative-position coordinates may be used.

#### Examples

Creates a window with callback:

```
hWin2 = WM_CreateWindow(100, 10, 180, 100, WM_CF_SHOW, &_cbWin, 0);
```

Creates a window without callback:

```
hWin2 = WM_CreateWindow(100, 10, 180, 100, WM_CF_SHOW, NULL, 0);
```

### 7.1.8.2.9 WM\_CreateWindowAsChild()

#### Description

Creates a window as a child window.

#### Prototype

```
WM_HWIN WM_CreateWindowAsChild(int x0,
                                int y0,
                                int width,
                                int height,
                                WM_HWIN hParent,
                                U32 Style,
                                WM_CALLBACK * cb,
                                int NumExtraBytes);
```

#### Parameters

Parameter	Description
<code>x0</code>	Upper left X-position in window coordinates of the parent window.
<code>y0</code>	Upper left Y-position in window coordinates of the parent window.
<code>width</code>	X-size of window. If 0, X-size of client area of parent window.
<code>height</code>	Y-size of window. If 0, Y-size of client area of parent window.
<code>hWinParent</code>	Handle of parent window.
<code>Style</code>	Window create flags (see <i>Window create flags</i> on page 1146).
<code>cb</code>	Pointer to callback routine, or <code>NULL</code> if no callback used.
<code>NumExtraBytes</code>	Number of extra bytes to be allocated, normally 0.

#### Return value

Handle to the created window.

#### Additional information

If the `hWinParent` parameter is set to 0, the background window is used as parent. A child window is placed on top of its parent and any previous siblings by default, so that if their Z-positions are not changed, the “youngest” window will always be topmost.

The Z-positions of siblings may be changed, although they will always remain on top of their parent regardless of their order.

### 7.1.8.2.10 WM\_Deactivate()

#### Description

Deactivates the Window Manager.

#### Prototype

```
void WM_Deactivate(void);
```

#### Additional information

After calling this function, the clip area is set to the complete LCD area and the WM will not execute window callback functions.

### 7.1.8.2.11 WM\_DefaultProc()

#### Description

Default message handler.

#### Prototype

```
void WM_DefaultProc(WM_MESSAGE * pMsg);
```

#### Parameters

Parameter	Description
<code>pMsg</code>	Pointer to message.

#### Additional information

Use this function to handle unprocessed messages as in the following example:

```
static WM_RESULT cbBackgroundWin(WM_MESSAGE * pMsg) {  
    switch (pMsg->MsgId) {  
        case WM_PAINT:  
            GUI_Clear();  
            break;  
        default:  
            WM_DefaultProc(pMsg);  
    }  
}
```

### 7.1.8.2.12 WM\_DeleteWindow()

#### Description

Deletes a specified window.

#### Prototype

```
void WM_DeleteWindow(WM_HWIN hWin);
```

#### Parameters

Parameter	Description
<code>hWin</code>	Window handle.

#### Additional information

Before the window is deleted, it receives a `WM_DELETE` message. This message is typically used to delete any objects (widgets) it uses and to free memory dynamically allocated by the window.

If the specified window has any existing child windows, these are automatically deleted before the window itself is deleted. Child windows therefore do not need to be separately deleted.

Before the window will be deleted it sends a `WM_NOTIFICATION_CHILD_DELETED` message to its parent window.



### 7.1.8.2.13 WM\_DeleteWindowSecure()

#### Description

Deletes a window safely. The window is deleted upon the next execution of `GUI_Exec()`. This routine should be used if e.g. a window should be deleted within its callback.

#### Prototype

```
void WM_DeleteWindowSecure(WM_HWIN hWin);
```

#### Parameters

Parameter	Description
<code>hWin</code>	Window handle.

### 7.1.8.2.14 WM\_DetachWindow()

#### Description

Detaches a window from its parent window. Detached windows will not be redrawn by the Window Manager.

#### Prototype

```
void WM_DetachWindow(WM_HWIN hWin);
```

#### Parameters

Parameter	Description
<code>hWin</code>	Window handle.

### 7.1.8.2.15 WM\_DisableWindow()

#### Description

Disables the specified window. The WM does not pass user input messages (touch, mouse, joystick, ...) to a disabled window.

#### Prototype

```
void WM_DisableWindow(WM_HWIN hWin);
```

#### Parameters

Parameter	Description
<code>hWin</code>	Window handle.

#### Additional information

A widget that is disabled will typically appear gray, and will not accept input from the user. However, the actual appearance may vary (depends on widget/configuration settings, etc.). A disabled window will not receive the following messages: WM\_TOUCH, WM\_TOUCH\_CHILD, WM\_PID\_STATE\_CHANGED and WM\_MOUSEOVER.

### 7.1.8.2.16 WM\_EnableWindow()

#### Description

Sets the specified window to enabled state. An enabled window receives pointer input device (PID) messages (touch, mouse, joystick, ...) from the WM.

#### Prototype

```
void WM_EnableWindow(WM_HWIN hWin);
```

#### Parameters

Parameter	Description
<code>hObj</code>	Handle of window.

#### Additional information

This is the default setting for any widget.

### 7.1.8.2.17 WM\_Exec()

#### Description

This function takes care of handling window related input and redrawing of invalid windows.

#### Prototype

```
int WM_Exec(void);
```

#### Return value

0 if there were no jobs performed (or only one window has been drawn).  
1 if a job was performed.

#### Additional information

This function keeps the WindowManager 'alive'. `WM_Exec()` gets also called by `GUI_Exec()`. A return value of 0 does not necessarily mean that nothing has been done by the Window Manager. If only one window is invalid and no input has to be processed, `WM_Exec()` will return 0 as well.

To check if something has been done, albeit `WM_Exec()` returns zero, the function `WM_GetNumInvalidWindows()` can be used.

```
r = WM_GetNumInvalidWindows();  
r |= WM_Exec();  
if (r) {  
    // Something has been done  
}
```

In general this function does not need to be called by the user application and it is recommended to call `GUI_Exec()` instead. Therefore, it is also called by `GUI_Delay()`, which is recommended in a multitasking environment.

### 7.1.8.2.18 WM\_Exec1()

#### Description

This function handles one job. This means, handling either one touch input or one paint event.

#### Prototype

```
int WM_Exec1(void);
```

#### Return value

0        if there were no jobs performed.  
1        if a job was performed.

#### Additional information

This routine may be called repeatedly until 0 is returned, which means all jobs have been completed.

It is recommended to call the function `GUI_Exec1()` instead.

### 7.1.8.2.19 WM\_ForEachDesc()

#### Description

Iterates over all descendants of the given window. A descendant of a window is a child window or a grand child window or a child of a grand child and so on.

#### Prototype

```
void WM_ForEachDesc(WM_HWIN      hWin,
                   WM_tfForEach * pcb,
                   void          * pData);
```

#### Parameters

Parameter	Description
<code>hWin</code>	Window handle.
<code>pcb</code>	Pointer to callback function to be called by <code>WM_ForEachDesc</code> .
<code>pData</code>	User data to be passed to the callback function.

#### Additional information

This function calls the callback function given by the pointer `pcb` for each descendant of the given window. The parameter `pData` will be passed to the user function and can be used to point to user defined data.

#### Prototype of callback function

```
void CallbackFunction(WM_HWIN hWin,
                     void * pData);
```

#### Example

The following example shows how the function can be used. It creates 3 windows, the first as a child window of the desktop, the second as a child window of the first window and the third as a child window of the second window. After creating the window it uses `WM_ForEachDesc()` to move each window within its parent window:

```
static void _cbWin(WM_MESSAGE * pMsg) {
    GUI_COLOR Color;
    switch (pMsg->MsgId) {
    case WM_PAINT:
        WM_GetUserData(pMsg->hWin, &Color, 4);
        GUI_SetBkColor(Color);
        GUI_Clear();
        break;
    default:
        WM_DefaultProc(pMsg);
    }
}
static void _cbDoSomething(WM_HWIN hWin, void * p) {
    int Value = *(int *)p;
    WM_MoveWindow(hWin, Value, Value);
}
void MainTask(void) {
    WM_HWIN hWin_1, hWin_2, hWin_3;
    int Value = 10;
    GUI_COLOR aColor[] = {GUI_RED, GUI_GREEN, GUI_BLUE};
    GUI_Init();
    WM_SetDesktopColor(GUI_BLACK);
    hWin_1 = WM_CreateWindow( 10, 10, 100, 100, WM_CF_SHOW, _cbWin, 4);
    hWin_2 = WM_CreateWindowAsChild(10, 10, 80, 80, hWin_1, WM_CF_SHOW, _cbWin, 4);
    hWin_3 = WM_CreateWindowAsChild(10, 10, 60, 60, hWin_2, WM_CF_SHOW, _cbWin, 4);
    WM_SetUserData(hWin_1, &aColor[0], 4);
    WM_SetUserData(hWin_2, &aColor[1], 4);
}
```

```
WM_SetUserData(hWin_3, &aColor[2], 4);  
while(1) {  
    WM_ForEachDesc(WM_HBKWIN, _cbDoSomething, (void *)&Value);  
    Value *= -1;  
    GUI_Delay(500);  
}  
}
```



### 7.1.8.2.20 WM\_GetActiveWindow()

#### Description

Returns the handle of the active window used for drawing operations.

#### Prototype

```
WM_HWIN WM_GetActiveWindow(void);
```

#### Return value

The handle of the active window.

#### Additional information

This function should be used only when the message WM\_PAINT is processed in a window callback function.

### 7.1.8.2.21 WM\_GetCallback()

#### Description

Returns a pointer to the callback function of the given window.

#### Prototype

```
WM_CALLBACK *WM_GetCallback(WM_HWIN hWin);
```

#### Parameters

Parameter	Description
<code>hWin</code>	Window handle.

#### Additional information

Pointer of type `WM_CALLBACK` which points to the callback function of the given window. If the window has no callback function, `NULL` is returned.

### 7.1.8.2.22 WM\_GetCapture()

#### Description

Returns the window that currently has the capture. This function can be useful to retrieve the current capture state to reset it afterwards.

#### Prototype

```
WM_HWIN WM_GetCapture(int * pAutoRelease);
```

#### Parameters

Parameter	Description
<code>pAutoRelease</code>	<code>out</code> Pointer to an integer to save the currently saved auto release option.

#### Return value

- `≠ 0` Window that currently has the capture.
- `= 0` No window currently has the capture.

### 7.1.8.2.23 WM\_GetChild()

#### Description

Returns the window handle of the requested child item (widget).

#### Prototype

```
WM_HWIN WM_GetChild(WM_HWIN hWin,  
                    int      Id);
```

#### Parameters

Parameter	Description
<a href="#">hDialog</a>	Parent handle of the widget.
<a href="#">Id</a>	Window <a href="#">Id</a> of the widget.

#### Return value

The window handle of the widget.

#### Additional information

In contrast to `WM_GetDialogItem()` the function does not work recursively. This means that this function will only return direct children but e.g. no grandchildren.

### 7.1.8.2.24 WM\_GetClientRect()

#### Description

Returns the coordinates of the client area in the active window in window coordinates. That means x0 and y0 of the `GUI_RECT` structure will be 0, x1 and y1 corresponds to the size - 1.

#### Prototype

```
void WM_GetClientRect(GUI_RECT * pRect);
```

#### Parameters

Parameter	Description
<code>pRect</code>	Pointer to a <code>GUI_RECT</code> structure.

### 7.1.8.2.25 WM\_GetClientRectEx()

#### Description

Returns the coordinates of the client area of a window in window coordinates. That means x0 and y0 of the `GUI_RECT` structure will be 0, x1 and y1 corresponds to the size - 1.

#### Prototype

```
void WM_GetClientRectEx(WM_HWIN    hWin,  
                       GUI_RECT * pRect);
```

#### Parameters

Parameter	Description
<code>hWin</code>	Window handle.
<code>pRect</code>	Pointer to a <code>GUI_RECT</code> structure.

### 7.1.8.2.26 WM\_GetDesktopWindow()

#### Description

Returns the handle of the desktop window.

#### Prototype

```
WM_HWIN WM_GetDesktopWindow(void);
```

#### Return value

The handle of the desktop window.

#### Additional information

The desktop window is always the bottommost window and any further created windows are its descendants.

### 7.1.8.2.27 WM\_GetDesktopWindowEx()

#### Description

Returns the handle of the specified desktop window when working in a multi layer environment.

#### Prototype

```
WM_HWIN WM_GetDesktopWindowEx(unsigned int LayerIndex);
```

#### Parameters

Parameter	Description
<a href="#">LayerIndex</a>	Index of layer.

#### Return value

The handle of the specified desktop window.



### 7.1.8.2.28 WM\_GetDialogItem()

#### Description

Returns the window handle of a dialog box item (widget).

#### Prototype

```
WM_HWIN WM_GetDialogItem(WM_HWIN hWin,  
                          int Id);
```

#### Parameters

Parameter	Description
<code>hDialog</code>	Parent handle of the widget.
<code>Id</code>	Window <code>Id</code> of the widget.

#### Return value

The window handle of the widget.

#### Additional information

This function is always used when creating dialog boxes, since the window `Id` of a widget used in a dialog must be converted to its handle before it can be used.

### 7.1.8.2.29 WM\_GetFirstChild()

#### Description

Returns the handle of a specified window's first child window.

#### Prototype

```
WM_HWIN WM_GetFirstChild(WM_HWIN hWin);
```

#### Parameters

Parameter	Description
<a href="#">hWin</a>	Window handle.

#### Return value

Handle of the window's first child window; 0 if no child window exists.

#### Additional information

A window's first child window is the first child created to that particular parent. If the Z-positions of the windows have not been changed, it will be the window directly on top of the specified parent.

### 7.1.8.2.30 WM\_GetFocusedWindow()

#### Description

Returns the handle of the window with the input focus.

#### Prototype

```
WM_HWIN WM_GetFocusedWindow(void);
```

#### Return value

Handle of the window with the input focus or 0 if no window has the input focus.

### 7.1.8.2.31 WM\_GetHasTrans()

#### Description

Returns the current value of the has transparency flag.

#### Prototype

```
int WM_GetHasTrans(WM_HWIN hWin);
```

#### Parameters

Parameter	Description
<code>hWin</code>	Window handle.

#### Return value

0        no transparency  
1        window has transparency

#### Additional information

When set, this flag tells the Window Manager that a window contains sections which are not redrawn and will therefore be transparent. The WM then knows that the background needs to be redrawn prior to redrawing the window in order to make sure the transparent sections are restored correctly.

### 7.1.8.2.32 WM\_GetInvalidRect()

#### Description

Returns the invalid rectangle of a window in desktop coordinates.

#### Prototype

```
int WM_GetInvalidRect(WM_HWIN hWin,  
                     GUI_RECT * pRect);
```

#### Parameters

Parameter	Description
<code>hWin</code>	Window handle.
<code>pRect</code>	Pointer to a GUI_RECT-structure for storing the invalid rectangle.

#### Return value

0 if nothing is invalid.  
1 otherwise.

### 7.1.8.2.33 WM\_GetModalLayer()

#### Description

Returns the current modal layer. Per default there does not exist a modal layer. In that case the function returns -1.

#### Prototype

```
int WM_GetModalLayer(void);
```

#### Return value

$\geq 0$       Index of current modal layer.  
= -1        No modal layer is used.

#### Additional information

Additional information can be found in the description of `WM_SetModalLayer()`.

### 7.1.8.2.34 WM\_GetModalWindow()

#### Description

Returns the modal window.

#### Prototype

```
WM_HWIN WM_GetModalWindow(void);
```

#### Return value

= 0      If there is no modal window.  
≠ 0      Handle of the modal window.

### 7.1.8.2.35 WM\_GetNextSibling()

#### Description

Returns the handle of a specified window's next sibling.

#### Prototype

```
WM_HWIN WM_GetNextSibling(WM_HWIN hWin);
```

#### Parameters

Parameter	Description
<code>hWin</code>	Window handle.

#### Return value

Handle of the window's next sibling.  
0 if none exists.

#### Additional information

A window's next sibling is the next child window that was created relative to the same parent. If the Z-positions of the windows have not been changed, it will be the window directly on top of the one specified.



### 7.1.8.2.36 WM\_GetNumInvalidWindows()

#### Description

Returns the number of currently invalid windows.

#### Prototype

```
int WM_GetNumInvalidWindows(void);
```

#### Return value

Number of invalid windows.

### 7.1.8.2.37 WM\_GetOrgX()

### 7.1.8.2.38 WM\_GetOrgY()

#### Description

Returns the X- or Y-position (respectively) of the origin of the active window in desktop coordinates.

#### Prototypes

```
int WM_GetOrgX(void);
```

```
int WM_GetOrgY(void);
```

#### Return value

X- or Y-position of the origin of the active window in desktop coordinates.

### 7.1.8.2.39 WM\_GetParent()

#### Description

Returns the handle of a specified window's parent window.

#### Prototype

```
WM_HWIN WM_GetParent(WM_HWIN hWin);
```

#### Parameters

Parameter	Description
<a href="#">hWin</a>	Window handle.

#### Return value

Handle of the window's parent window.  
0 if none exists.

#### Additional information

The only case in which no parent window exists is if the handle of the desktop window is used as parameter.

### 7.1.8.2.40 WM\_GetPrevSibling()

#### Description

Returns the handle of a specified window's previous sibling.

#### Prototype

```
WM_HWIN WM_GetPrevSibling(WM_HWIN hWin);
```

#### Parameters

Parameter	Description
<code>hWin</code>	Window handle.

#### Return value

Handle of the window's previous sibling.  
0 if none exists.

#### Additional information

A window's previous sibling is the previous child window that was created relative to the same parent. If the Z-positions of the windows have not been changed, it will be the window directly below of the one specified.

### 7.1.8.2.41 WM\_GetStayOnTop()

#### Description

Returns the current value of the stay on top flag.

#### Prototype

```
int WM_GetStayOnTop(WM_HWIN hWin);
```

#### Parameters

Parameter	Description
<code>hWin</code>	Window handle.

#### Return value

- 0 stay on top flag not set
- 1 stay on top flag set

### 7.1.8.2.42 WM\_GetUserData()

#### Description

Retrieves the data set with WM\_SetUserData().

#### Prototype

```
int WM_GetUserData(WM_HWIN hWin,
                  void * pDest,
                  int NumBytes);
```

#### Parameters

Parameter	Description
<code>hWin</code>	Window handle.
<code>pDest</code>	Pointer to buffer.
<code>SizeOfBuffer</code>	Size of buffer.

#### Return value

≠ 0      Number of bytes retrieved.  
 = 0      If the given handle is NULL.

#### Additional information

The maximum number of bytes returned by this function is the number of ExtraBytes specified when creating the window. This function must not be used with widgets. If used with widgets wrong values will be returned. The widget specific function

< WIDGET>\_SetUserData()      has to be used.

### 7.1.8.2.43 WM\_GetWindowOrgX()

### 7.1.8.2.44 WM\_GetWindowOrgY()

#### Description

Returns the X- or Y-position (respectively) of the origin of the specified window in desktop coordinates.

#### Prototypes

```
int WM_GetWindowOrgX(WM_HWIN hWin);
```

```
int WM_GetWindowOrgY(WM_HWIN hWin);
```

#### Parameters

Parameter	Description
<code>hWin</code>	Window handle.

#### Return value

X- or Y-position of the client area in pixels.

### 7.1.8.2.45 WM\_GetWindowRect()

#### Description

Returns the coordinates of the active window in desktop coordinates.

#### Prototype

```
void WM_GetWindowRect(GUI_RECT * pRect);
```

#### Parameters

Parameter	Description
<code>pRect</code>	Pointer to a GUI_RECT structure.



### 7.1.8.2.46 WM\_GetWindowRectEx()

#### Description

Returns the coordinates of a window in desktop coordinates.

#### Prototype

```
void WM_GetWindowRectEx(WM_HWIN    hWin,  
                        GUI_RECT * pRect);
```

#### Parameters

Parameter	Description
<code>hWin</code>	Window handle.
<code>pRect</code>	Pointer to a <code>GUI_RECT</code> structure.

#### Additional information

If the given window handle is 0 or the given pointer to the `GUI_RECT` structure is `NULL` the function returns immediately.

### 7.1.8.2.47 WM\_GetWindowSizeX()

### 7.1.8.2.48 WM\_GetWindowSizeY()

#### Description

Return the X- or Y-size (respectively) of a specified window.

#### Prototypes

```
int WM_GetWindowSizeX(WM_HWIN hWin);
```

```
int WM_GetWindowSizeY(WM_HWIN hWin);
```

#### Parameters

Parameter	Description
<code>hWin</code>	Window handle.

#### Return value

X- or Y-size of the window in pixels.

Defined as  $x_1 - x_0 + 1$  in horizontal direction,  $y_1 - y_0 + 1$  in vertical direction, where  $x_0$ ,  $x_1$ ,  $y_0$ ,  $y_1$  are the leftmost/rightmost/topmost/bottommost positions of the window. If the given window handle is 0 the function returns the size of the desktop window.

### 7.1.8.2.49 WM\_HasCaptured()

#### Description

Checks if the given window has captured PID input.

#### Prototype

```
int WM_HasCaptured(WM_HWIN hWin);
```

#### Parameters

Parameter	Description
<code>hWin</code>	Window handle.

#### Return value

1 if the given window has captured mouse- and touchscreen-input.  
0 if not.

#### Additional information

If the given window handle is invalid or 0 the function returns a wrong result.

### 7.1.8.2.50 WM\_HasFocus()

#### Description

Checks if the given window has the input focus.

#### Prototype

```
int WM_HasFocus(WM_HWIN hWin);
```

#### Parameters

Parameter	Description
<code>hWin</code>	Window handle.

#### Return value

1 if the given window has the input focus.  
0 if not.

#### Additional information

If the given window handle is invalid or 0 the function returns a wrong result.

### 7.1.8.2.51 WM\_HideWindow()

#### Description

Makes a specified window invisible.

#### Prototype

```
void WM_HideWindow(WM_HWIN hWin);
```

#### Parameters

Parameter	Description
<code>hWin</code>	Window handle.

#### Additional information

The window will not immediately appear “invisible” after calling this function. The invalid areas of other windows (areas which appear to lie “behind” the window which should be hidden) will be redrawn when executing `WM_Exec()`. If you need to hide (draw over) a window immediately, you should call `WM_Paint()` to redraw the other windows.

### 7.1.8.2.52 WM\_InvalidateArea()

#### Description

Invalidates a specified, rectangular area of the display.

#### Prototype

```
void WM_InvalidateArea(const GUI_RECT * pRect);
```

#### Parameters

Parameter	Description
<code>pRect</code>	Pointer to a GUI_RECT structure with desktop coordinates.

#### Additional information

Calling this function will tell the WM that the specified area is not updated. This function can be used to invalidate any windows or parts of windows that overlap or intersect the area. The coordinates of the GUI\_RECT structure have to be in desktop coordinates.

### 7.1.8.2.53 WM\_InvalidateRect()

#### Description

Invalidates a specified, rectangular area of a window.

#### Prototype

```
void WM_InvalidateRect(      WM_HWIN    hWin,  
                           const GUI_RECT * pRect);
```

#### Parameters

Parameter	Description
<code>hWin</code>	Window handle.
<code>pRect</code>	Pointer to a <code>GUI_RECT</code> structure with window coordinates of the parent window.

#### Additional information

Calling this function will tell the WM that the specified area is not updated. The next time the Window Manager is executed so the window is redrawn, the area will be redrawn as well. The `GUI_RECT` structure has to be filled with window coordinates.

### 7.1.8.2.54 WM\_InvalidateWindow()

#### Description

Invalidates a specified window.

#### Prototype

```
void WM_InvalidateWindow(WM_HWIN hWin);
```

#### Parameters

Parameter	Description
<code>hWin</code>	Window handle.

#### Additional information

Calling this function tells the WM that the specified window is not updated.



### 7.1.8.2.55 WM\_IsCompletelyCovered()

#### Description

Checks if the given window is completely covered or not.

#### Prototype

```
char WM_IsCompletelyCovered(WM_HWIN hWin);
```

#### Parameters

Parameter	Description
<code>hWin</code>	Window handle.

#### Return value

1 if the given window is completely covered.  
0 if not.

#### Additional information

If the given window handle is invalid or 0 the function returns a wrong result.

### 7.1.8.2.56 WM\_IsCompletelyVisible()

#### Description

Checks if the given window is completely visible or not.

#### Prototype

```
char WM_IsCompletelyVisible(WM_HWIN hWin);
```

#### Parameters

Parameter	Description
<code>hWin</code>	Window handle.

#### Return value

- 1 if the given window is completely visible.
- 0 if it is clipped at its parents borders.

#### Additional information

If the given window handle is invalid or 0 the function returns a wrong result.

### 7.1.8.2.57 WM\_IsEnabled()

#### Description

This function returns if a window is enabled or not.

#### Prototype

```
int WM_IsEnabled(WM_HWIN hObj);
```

#### Parameters

Parameter	Description
<a href="#">hObj</a>	Window handle.

#### Return value

1 if the window is enabled.  
0 if not.

#### Additional information

A widget that is disabled will typically appear gray, and will not accept input from the user. However, the actual appearance may vary (depends on widget/configuration settings, etc.)

### 7.1.8.2.58 WM\_IsUntouchable()

#### Description

Returns whether the given window has the untouchable flag set.

#### Prototype

```
int WM_IsUntouchable(WM_HWIN hWin);
```

#### Parameters

Parameter	Description
<a href="#">hWin</a>	Window handle.

#### Return value

- 1 Error.
- 0 Window is not untouchable.
- 1 Window is untouchable.

### 7.1.8.2.59 WM\_IsVisible()

#### Description

Determines whether or not a specified window is visible.

#### Prototype

```
int WM_IsVisible(WM_HWIN hWin);
```

#### Parameters

Parameter	Description
<code>hWin</code>	Window handle.

#### Return value

- 0 if the window is not visible.
- 1 if the window is visible.

### 7.1.8.2.60 WM\_IsWindow()

#### Description

Determines whether or not a specified handle is a valid window handle.

#### Prototype

```
int WM_IsWindow(WM_HWIN hWin);
```

#### Parameters

Parameter	Description
<code>hWin</code>	Window handle.

#### Return value

- 0 handle is not a valid window handle.
- 1 handle is a valid window handle.

#### Additional information

This function should be used only if absolutely necessary. The more windows exist the more time will be used to evaluate, if the given handle is a window.

### 7.1.8.2.61 WM\_MakeModal()

#### Description

This function makes the window work in 'modal' mode. This means pointer device input will only be sent to the 'modal' window or a child window of it if the input position is within the rectangle of the modal window.

#### Prototype

```
void WM_MakeModal(WM_HWIN hWin);
```

#### Parameters

Parameter	Description
<code>hWin</code>	Window handle. 0 removes the modal state from the current modal window.

### 7.1.8.2.62 WM\_MoveChildTo()

#### Description

Moves a specified window to a certain position.

#### Prototype

```
void WM_MoveChildTo(WM_HWIN hWin,  
                   int      x,  
                   int      y);
```

#### Parameters

Parameter	Description
<code>hWin</code>	Window handle.
<code>x</code>	New X-position in window coordinates of the parent window.
<code>y</code>	New Y-position in window coordinates of the parent window.



### 7.1.8.2.63 WM\_MoveTo()

#### Description

Moves a specified window to a certain position.

#### Prototype

```
void WM_MoveTo(WM_HWIN hWin,  
               int      x,  
               int      y);
```

#### Parameters

Parameter	Description
<a href="#">hWin</a>	Window handle.
<a href="#">x</a>	New X-position in desktop coordinates.
<a href="#">y</a>	New Y-position in desktop coordinates.

### 7.1.8.2.64 WM\_MoveWindow()

#### Description

Moves a specified window by a certain distance.

#### Prototype

```
void WM_MoveWindow(WM_HWIN hWin,  
                  int dx,  
                  int dy);
```

#### Parameters

Parameter	Description
<a href="#">hWin</a>	Window handle.
<a href="#">dx</a>	Horizontal distance to move.
<a href="#">dy</a>	Vertical distance to move.

### 7.1.8.2.65 WM\_NotifyParent()

#### Description

Sends a WM\_NOTIFY\_PARENT message to the given window.

#### Prototype

```
void WM_NotifyParent(WM_HWIN hWin,  
                   int Notification);
```

#### Parameters

Parameter	Description
<code>hWin</code>	Window handle.
<code>Notification</code>	Value to send to the parent window.

#### Additional information

The `Notification` parameter will be sent in the `Data.v` element of the message. The macro `WM_NOTIFICATION_USER` can be used for defining application defined messages:

```
#define NOTIFICATION_1 (WM_NOTIFICATION_USER + 0)  
#define NOTIFICATION_2 (WM_NOTIFICATION_USER + 1)
```

### 7.1.8.2.66 WM\_Paint()

#### Description

Draws or redraws a specified window immediately.

#### Prototype

```
void WM_Paint(WM_HWIN hWin);
```

#### Parameters

Parameter	Description
<code>hWin</code>	Window handle.

#### Additional information

The window is redrawn reflecting all updates made since the last time it was drawn.

### 7.1.8.2.67 WM\_PaintWindowAndDescs()

#### Description

Paints the given window and all its descendants.

#### Prototype

```
void WM_PaintWindowAndDescs(WM_HWIN hWin);
```

#### Parameters

Parameter	Description
<code>hWin</code>	Window handle.

#### Additional information

The function draws the complete window regions by invalidating them before drawing.

### 7.1.8.2.68 WM\_Rect2Client()

#### Description

Converts the given rectangle holding coordinates relative to the screen into coordinates relative to the window.

#### Prototype

```
void WM_Rect2Client(WM_HWIN    hWin,  
                  GUI_RECT * pRect);
```

#### Parameters

Parameter	Description
<code>hWin</code>	Window handle.
<code>pRect</code>	Pointer to a rectangle with coordinates relative to the screen.

### 7.1.8.2.69 WM\_Rect2Screen()

#### Description

Converts the given rectangle holding coordinates relative to the given window into screen positions.

#### Prototype

```
void WM_Rect2Screen(WM_HWIN    hWin,  
                   GUI_RECT * pRect);
```

#### Parameters

Parameter	Description
<code>hWin</code>	Window handle.
<code>pRect</code>	Pointer to a rectangle with coordinates relative to the window.

#### Additional information

This function is useful when using Memory Devices in combination with windows/widgets, because Memory Device use coordinates relative to the screen.

### 7.1.8.2.70 WM\_ReleaseCapture()

#### Description

Releases capturing of mouse- and touchscreen-input.

#### Prototype

```
void WM_ReleaseCapture(void);
```

#### Additional information

Use `WM_SetCapture()` to send all mouse- and touchscreen-input to a specific window.



### 7.1.8.2.71 WM\_ResizeWindow()

#### Description

Changes the size of a specified window by adding (or subtracting) the given differences.

#### Prototype

```
void WM_ResizeWindow(WM_HWIN hWin,  
                    int dx,  
                    int dy);
```

#### Parameters

Parameter	Description
<a href="#">hWin</a>	Window handle.
<a href="#">dx</a>	Difference in X.
<a href="#">dy</a>	Difference in Y.

### 7.1.8.2.72 WM\_Screen2hWin()

#### Description

Returns the window which lies at the specified position.

#### Prototype

```
WM_HWIN WM_Screen2hWin(int x,  
                       int y);
```

#### Parameters

Parameter	Description
<code>x</code>	X-coordinate
<code>y</code>	Y-coordinate

#### Return value

Handle to the found window.

### 7.1.8.2.73 WM\_Screen2hWinEx()

#### Description

Returns the window which lies at the specified position.

#### Prototype

```
WM_HWIN WM_Screen2hWinEx(WM_HWIN hStop,  
                          int      x,  
                          int      y);
```

#### Parameters

Parameter	Description
<a href="#">hStop</a>	Handle of a descendant (low-level window) to stop at.
<a href="#">x</a>	X-coordinate
<a href="#">y</a>	Y-coordinate

#### Return value

Handle to the found window. If [hStop](#) was found the handle to its parent window is returned.

### 7.1.8.2.74 WM\_SelectWindow()

#### Description

Selects a window to be used for drawing operations. The selected window is also called the active window.

#### Prototype

```
WM_HWIN WM_SelectWindow(WM_HWIN hWin);
```

#### Parameters

Parameter	Description
<code>hWin</code>	Window handle.

#### Return value

The previously selected window.

#### Additional information

If using this function it is possible to paint into a window from outside of the Window Manager, in general this is not recommended. Further you will not benefit from the automatic multi buffering and memory device feature of the Window Manager. Use this function very rarely and only as a last choice.

This function should not be called within a paint function called by the Window Manager. If the Window Manager sends a `WM_PAINT` message the target window already has been selected.

When working with a multi layer configuration the function switches also to the layer of the top level parent window of the given window.

If the given window handle is 0 the function selects the first created window, normally the first desktop window.

#### Example

Sets a window with handle `hWin2` to the active window, sets the background color, and then clears the window:

```
WM_SelectWindow(hWin2);
GUI_SetBkColor(0xFF00);
GUI_Clear();
```

### 7.1.8.2.75 WM\_SendMessage()

#### Description

Sends a message to a specified window.

#### Prototype

```
void WM_SendMessage(WM_HWIN      hWin,  
                   WM_MESSAGE * pMsg);
```

#### Parameters

Parameter	Description
<code>hWin</code>	Window handle.
<code>pMsg</code>	Pointer to a <code>WM_MESSAGE</code> structure. See <i>Elements of structure WM_MESSAGE</i> .

#### Additional information

This function can be also used to send custom messages as described in the section *Application-defined messages* on page 981.

### 7.1.8.2.76 WM\_SendMessageNoPara()

#### Description

Sends a message without parameters to a specified window.

#### Prototype

```
void WM_SendMessageNoPara(WM_HWIN hWin,  
                           int      MsgId);
```

#### Parameters

Parameter	Description
<code>hWin</code>	Window handle.
<code>MsgId</code>	Id of message to be sent.

#### Additional information

If only a message Id should be sent to a window this should be done with this function, because it does not need a pointer to a `WM_MESSAGE` structure. Note that the receiving window gets no further information except the message Id.

This function can be used to send application-defined messages. Refer to the chapter *Application-defined messages* on page 981.

### 7.1.8.2.77 WM\_SendToParent()

#### Description

Sends the given message to the parent window of the given window.

#### Prototype

```
void WM_SendToParent(WM_HWIN      hChild,  
                    WM_MESSAGE * pMsg);
```

#### Parameters

Parameter	Description
<code>hWin</code>	Window handle.
<code>pMsg</code>	Pointer to WM_MESSAGE-structure.

### 7.1.8.2.78 WM\_SetCallback()

#### Description

Sets a callback routine to be executed by the Window Manager.

#### Prototype

```
WM_CALLBACK *WM_SetCallback(WM_HWIN hWin,  
                             WM_CALLBACK * cb);
```

#### Parameters

Parameter	Description
<a href="#">hWin</a>	Window handle.
<a href="#">cb</a>	Pointer to callback routine.

#### Return value

Pointer to the previous callback routine.

#### Additional information

The given window will be invalidated. This makes sure the window will be redrawn.



### 7.1.8.2.79 WM\_SetCapture()

#### Description

Routes all PID-messages to the given window.

#### Prototype

```
void WM_SetCapture(WM_HWIN hObj,  
                  int      AutoRelease);
```

#### Parameters

Parameter	Description
<code>hWin</code>	Window handle.
<code>AutoRelease</code>	1 if capturing should end when the user releases the touch.

### 7.1.8.2.80 WM\_SetCaptureMove()

#### Description

Moves a window according to the given PID state. This function is intended to be used in a window callback function. It should react to the message WM\_TOUCH if the PID is in pressed state.

#### Prototype

```
void WM_SetCaptureMove(    WM_HWIN        hWin,
                          const GUI_PID_STATE * pState,
                          int             MinVisibility,
                          int             LimitTop);
```

#### Parameters

Parameter	Description
<code>hWin</code>	Handle of the window which should be moved.
<code>pState</code>	Pointer to the PID state.
<code>MinVisibility</code>	Defines the minimum visibility of the parent window in pixels. The window will not be moved farther than the parent window reduced by the minimum visibility.
<code>LimitTop</code>	Defines a number of top pixel lines which can not be moved outside the parent rectangle. The bottom pixel lines which are excluded are allowed to be moved outside the parent rectangle.

#### Example

The following example application shows a callback function of a window which is moved using WM\_SetCaptureMove():

```
static void _cbWin(WM_MESSAGE * pMsg) {
    const GUI_PID_STATE * pState;
    WM_HWIN hWin;
    hWin = pMsg->hWin;
    switch (pMsg->MsgId) {
    case WM_TOUCH:
        pState = (const GUI_PID_STATE *)pMsg->Data.p;
        if (pState) {
            if (pState->Pressed) {
                WM_SetCaptureMove(hWin, pState, 0, 0);
            }
        }
        break;
    case WM_PAINT:
        GUI_SetBkColor(GUI_DARKBLUE);
        GUI_Clear();
        break;
    default:
        WM_DefaultProc(pMsg);
    }
}

void MainTask(void) {
    WM_HWIN hWin;

    GUI_Init();
    WM_SetDesktopColor(GUI_DARKGREEN);
    hWin = WM_CreateWindow(10, 10, 200, 100, WM_CF_SHOW, _cbWin, 0);
    while (1) { GUI_Delay(1); }
}
```

### 7.1.8.2.81 WM\_SetCreateFlags()

#### Description

Sets the flags to be used as default when creating a new window.

#### Prototype

```
U32 WM_SetCreateFlags(U32 Flags);
```

#### Parameters

Parameter	Description
Flags	Window create flags (see <i>Window create flags</i> on page 1146).

#### Return value

Former value of this parameter.

#### Additional information

The flags specified here are binary ORed with the flags specified in the `WM_CreateWindow()` and `WM_CreateWindowAsChild()` routines.

The flag `WM_CF_MEMDEV` is frequently used to enable Memory Devices on all windows. Setting create flags is permitted before `GUI_Init()` is called. This causes the background window to be also affected by the create flags.

#### Example

```
WM_SetCreateFlags(WM_CF_MEMDEV); // Auto. use Memory Devices on all windows
```

### 7.1.8.2.82 WM\_SetDesktopColor()

#### Description

Sets the color for the desktop window.

#### Prototype

```
GUI_COLOR WM_SetDesktopColor(GUI_COLOR Color);
```

#### Parameters

Parameter	Description
Color	Color for desktop window, 24-bit RGB value.

#### Return value

The previously selected desktop window color.

#### Additional information

The default setting for the desktop window is not to repaint itself. If this function is not called, the desktop window will not be redrawn at all; therefore other windows will remain visible even after they are deleted.

Once a color is specified with this function, the desktop window will repaint itself. In order to restore the default, call this function and specify `GUI_INVALID_COLOR`.

### 7.1.8.2.83 WM\_SetDesktopColorEx()

#### Description

Sets the color for the desktop window in a multi layer environment.

#### Prototype

```
GUI_COLOR WM_SetDesktopColorEx(GUI_COLOR Color,  
                               unsigned int LayerIndex);
```

#### Parameters

Parameter	Description
<code>Color</code>	<code>Color</code> for desktop window, 24-bit RGB value.
<code>LayerIndex</code>	Index of the layer.

#### Return value

The previously selected desktop window color.

#### Additional information

See `WM_SetDesktopColor()`.

### 7.1.8.2.84 WM\_SetEnableState()

#### Description

Sets the window to an enabled or disabled state.

#### Prototype

```
void WM_SetEnableState(WM_HWIN hWin,  
                       int      State);
```

#### Parameters

Parameter	Description
<code>hWin</code>	Window handle.
<code>State</code>	1 to enable window, 0 to disable window.

### 7.1.8.2.85 WM\_SetFocus()

#### Description

Sets the input focus to a specified window.

#### Prototype

```
int WM_SetFocus(WM_HWIN hWin);
```

#### Parameters

Parameter	Description
<code>hWin</code>	Window handle.

#### Return value

= 0      if window accepted focus.  
≠ 0      if it could not.

#### Additional information

The window receives a `WM_SET_FOCUS` message which gives it the input focus. If for some reason the window could not accept the focus, nothing happens.

### 7.1.8.2.86 WM\_SetHasTrans()

#### Description

Enables transparency for the given window.

#### Prototype

```
void WM_SetHasTrans(WM_HWIN hWin);
```

#### Parameters

Parameter	Description
<code>hWin</code>	Window handle.

#### Additional information

Using this function causes the Window Manager to redraw the background of the given window in order to have the transparent parts updated before the actual window is drawn.



### 7.1.8.2.87 WM\_SetId()

#### Description

This function sends a WM\_SET\_ID message to the given window.

#### Prototype

```
void WM_SetId(WM_HWIN hObj,  
              int      Id);
```

#### Parameters

Parameter	Description
<a href="#">hObj</a>	Window handle.
<a href="#">Id</a>	<a href="#">Id</a> to be sent to the window.

#### Additional information

This function can be used to change the [Id](#) of a widget. It works with every widget. When using this function with an application defined window, the callback function of the window should handle the message. Otherwise it will be ignored.

### 7.1.8.2.88 WM\_SetModalLayer()

#### Description

emWin supports one modal window on each layer per default. But sometimes it could make sense to have only one modal window. To be able to achieve that function could be used. Once a modal layer has been set only windows of that layer will receive input.

#### Prototype

```
int WM_SetModalLayer(int LayerIndex);
```

#### Parameters

Parameter	Description
LayerIndex	Layer to be set as modal layer, -1 means no modal layer

#### Return value

- ≥ 0 Index of previous modal layer.
- = -1 No modal layer was used previously.
- = -2 Error.

### 7.1.8.2.89 WM\_SetpfPollPID()

#### Description

Sets a function which will be called by the Window Manager in order to poll the pointer input device (touch-screen or mouse).

#### Prototype

```
WM_tfPollPID *WM_SetpfPollPID(WM_tfPollPID * pf);
```

#### Parameters

Parameter	Description
<code>pf</code>	Pointer to a function of type <code>WM_tfPollPID</code> .

#### Return value

$\geq 0$  Index of previous modal layer.  
= -1 No modal layer was used previously.  
= -2 Error.

#### Additional information

The function type is defined as follows:

```
typedef void WM_tfPollPID(void);
```

#### Example

Example of a touch-screen handled as a device:

```
void ReadTouch(void) {  
    // ...read touchscreen  
}  
WM_SetpfPollPID(ReadTouch);
```

### 7.1.8.2.90 WM\_SetSize()

#### Description

Sets the new size of a window.

#### Prototype

```
void WM_SetSize(WM_HWIN hWin,  
               int      xSize,  
               int      ySize);
```

#### Parameters

Parameter	Description
<a href="#">hWin</a>	Window handle.
<a href="#">xSize</a>	New size in X.
<a href="#">ySize</a>	New size in Y.

### 7.1.8.2.91 WM\_SetUntouchable()

#### Description

This function makes a window 'untouchable'. It has the same effect than the create flag WM\_CF\_UNTOUCHABLE.

#### Prototype

```
int WM_SetUntouchable(WM_HWIN hWin,  
                     int      OnOff);
```

#### Parameters

Parameter	Description
<code>hWin</code>	Window handle.
<code>OnOff</code>	Enables (1) or disables (0) touch for a specific window.

#### Return value

Old status.

0 Window was previously not untouchable.

1 Window was previously untouchable.

#### Additional information

Calling this function will cause a window to route touch input to its parent. This way it is possible to place window over another window, but the lower window will still receive touch input.

### 7.1.8.2.92 WM\_SetWindowPos()

#### Description

Sets the size and the position of a window.

#### Prototype

```
void WM_SetWindowPos(WM_HWIN hWin,  
                    int      xPos,  
                    int      yPos,  
                    int      xSize,  
                    int      ySize);
```

#### Parameters

Parameter	Description
<a href="#">hWin</a>	Window handle.
<a href="#">xPos</a>	New position in X in desktop coordinates.
<a href="#">yPos</a>	New position in Y in desktop coordinates.
<a href="#">xSize</a>	New size in X.
<a href="#">ySize</a>	New size in Y.

### 7.1.8.2.93 WM\_SetXSize()

#### Description

Sets the new X-size of a window.

#### Prototype

```
int WM_SetXSize(WM_HWIN hWin,  
               int      XSize);
```

#### Parameters

Parameter	Description
<code>hWin</code>	Window handle.
<code>XSize</code>	New size in X.

### 7.1.8.2.94 WM\_SetYSize()

#### Description

Sets the new Y-size of a window.

#### Prototype

```
int WM_SetYSize(WM_HWIN hWin,  
                int      YSize);
```

#### Parameters

Parameter	Description
<code>hWin</code>	Window handle.
<code>YSize</code>	New size in Y.



### 7.1.8.2.95 WM\_SetStayOnTop()

#### Description

Sets the stay on top flag.

#### Prototype

```
void WM_SetStayOnTop(WM_HWIN hWin,  
                    int      OnOff);
```

#### Parameters

Parameter	Description
<code>hWin</code>	Window handle.
<code>OnOff</code>	1 for setting "Stay on stop" flag, 0 for clearing it.

### 7.1.8.2.96 WM\_SetTransState()

#### Description

This function sets or clears the flags `WM_CF_HASTRANS` and `WM_CF_CONST_OUTLINE` of the given window.

#### Prototype

```
void WM_SetTransState(WM_HWIN hWin,  
                     unsigned State);
```

#### Parameters

Parameter	Description
<code>hWin</code>	Window handle.
<code>State</code>	Combination of the flags <code>WM_CF_HASTRANS</code> and <code>WM_CF_CONST_OUTLINE</code> .

#### Additional information

Details about the flags `WM_CF_CONST_OUTLINE` and `WM_CF_HASTRANS` can be found in the function description of `WM_CreateWindow()`.

### 7.1.8.2.97 WM\_SetUserClipRect()

#### Description

Temporarily reduces the clip area of the current window to a specified rectangle.

#### Prototype

```
GUI_RECT *WM_SetUserClipRect(const GUI_RECT * pRect);
```

#### Parameters

Parameter	Description
<code>pRect</code>	Pointer to a <code>GUI_RECT</code> structure defining the clipping region in desktop coordinates.

#### Return value

Pointer to the previous clip rectangle.

#### Additional information

A `NULL` pointer can be passed in order to restore the default settings. The clip rectangle will automatically be reset by the WM when callbacks are used.

The specified rectangle must be relative to the current window. You cannot enlarge the clip rectangle beyond the current window rectangle.

Your application must ensure that the specified rectangle retains its value until it is no longer needed; that is, until a different clip rectangle is specified or until a `NULL` pointer is passed. This means that the rectangle structure passed as parameter should not be an auto variable (usually located on the stack) if the clip rectangle remains active until after the return. In this case, a static variable should be used.

#### Example

This example is taken from the drawing routine of a progress indicator. The progress indicator must write text on top of the progress bar, where the text color has to be different on the left and right parts of the bar. This means that half of a digit could be in one color, while the other half could be in a different color. The best way to do this is to temporarily reduce the clip area when drawing each part of the bar as shown below:

```
/* Draw left part of the bar */
r.x0=0; r.x1=x1-1; r.y0=0; r.y1 = GUI_YMAX;
WM_SetUserClipRect(&r);
GUI_SetBkColor(pThis->ColorBar[0]);
GUI_SetColor(pThis->ColorText[0]);
GUI_Clear();
GUI_GotoXY(xText,yText); GUI_DispDecMin(pThis->v); GUI_DispChar('%');
/* Draw right part of the bar */
r.x0=r.x1; r.x1=GUI_XMAX;
WM_SetUserClipRect(&r);
GUI_SetBkColor(pThis->ColorBar[1]);
GUI_SetColor(pThis->ColorText[1]);
GUI_Clear();
GUI_GotoXY(xText,yText); GUI_DispDecMin(pThis->v); GUI_DispChar('%');
```

#### Screenshot of progress bar

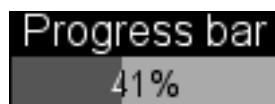

### 7.1.8.2.98 WM\_SetUserData()

#### Description

Sets the extra data of a window. Memory for extra data is reserved with the parameter NumExtraBytes when creating a window.

#### Prototype

```
int WM_SetUserData(      WM_HWIN  hWin,
                        const void * pSrc,
                        int      NumBytes);
```

#### Parameters

Parameter	Description
<code>hWin</code>	Window handle.
<code>pSrc</code>	Pointer to buffer.
<code>NumBytes</code>	Size of buffer.

#### Return value

Number of bytes written.

#### Additional information

It is important to specify the maximum number of bytes used as user data when creating the window. To be able to do that the function `WM_CreateUser()` has to be used. In case of creating widgets which should use user data the function(s)

`< WIDGET>_CreateUser()` must be used. This function must not be used with widgets. If used with widgets memory will be corrupted. Instead, the widget specific function `<WIDGET>_SetUserData()` has to be used. The maximum number of bytes used to store user data is the number of ExtraBytes specified when creating a window.

### 7.1.8.2.99 WM\_ShowWindow()

#### Description

Makes a specified window visible.

#### Prototype

```
void WM_ShowWindow(WM_HWIN hWin);
```

#### Parameters

Parameter	Description
<code>hWin</code>	Window handle.

#### Return value

Number of bytes written.

#### Additional information

The window will not immediately be visible after calling this function. It will be redrawn when executing `WM_Exec()`. If you need to show (draw) the window immediately, you should call `WM_Paint()`.

### 7.1.8.2.100 WM\_Update()

#### Description

Draws the invalid part of the specified window immediately.

#### Prototype

```
void WM_Update(WM_HWIN hWin);
```

#### Parameters

Parameter	Description
<code>hWin</code>	Window handle.

#### Additional information

After updating a window its complete region is marked as valid.

### 7.1.8.2.101 WM\_UpdateWindowAndDescs()

#### Description

Paints the invalid part of the given window and the invalid part of all its descendants.

#### Prototype

```
void WM_UpdateWindowAndDescs(WM_HWIN hWin);
```

#### Parameters

Parameter	Description
<code>hWin</code>	Window handle.

#### Additional information

The function only draws the invalid window regions.

### 7.1.8.2.102 WM\_ValidateRect()

#### Description

Validates a specified, rectangular area of a window.

#### Prototype

```
void WM_ValidateRect(      WM_HWIN    hWin,  
                        const GUI_RECT * pRect);
```

#### Parameters

Parameter	Description
<code>hWin</code>	Window handle.
<code>pRect</code>	Pointer to a <code>GUI_RECT</code> structure with window coordinates of the parent window.

#### Additional information

Calling this function will tell the WM that the specified area is updated. Normally this function is called internally and does not need to be called by the user application. The coordinates of the `GUI_RECT` structure have to be in desktop coordinates.



### 7.1.8.2.103 WM\_ValidateWindow()

#### Description

Validates a specified window.

#### Prototype

```
void WM_ValidateWindow(WM_HWIN hWin);
```

#### Parameters

Parameter	Description
<code>hWin</code>	Window handle.
<code>pRect</code>	Pointer to a <code>GUI_RECT</code> structure with window coordinates of the parent window.

#### Additional information

Calling this function will tell the WM that the specified window is updated. Normally this function is called internally and does not need to be called by the user application.

### 7.1.8.2.104 WM\_XY2Screen()

#### Description

Converts the given coordinates (relative to the given window) into screen coordinates.

#### Prototype

```
void WM_XY2Screen(WM_HWIN  hWin,  
                 int      * px,  
                 int      * py);
```

#### Parameters

Parameter	Description
<a href="#">hWin</a>	Window handle.
<a href="#">px</a>	Pointer to a x position to be converted.
<a href="#">py</a>	Pointer to a y position to be converted.

#### Additional information

This function is very useful when using Memory Devices in combination with windows/widgets, because Memory Device use coordinates relative to the screen.

### 7.1.8.2.105 WM\_XY2Client()

#### Description

Converts the given coordinates (relative to the screen) into coordinates relative to the given window.

#### Prototype

```
void WM_XY2Client(WM_HWIN hWin,  
                 int * px,  
                 int * py);
```

#### Parameters

Parameter	Description
<a href="#">hWin</a>	Window handle.
<a href="#">px</a>	Pointer to a x position to be converted.
<a href="#">py</a>	Pointer to a y position to be converted.

## 7.1.8.3 Motion support

### 7.1.8.3.1 WM\_MOTION\_Enable()

#### Description

Enables motion support for the WM. Needs to be called once at the beginning of the program.

#### Prototype

```
void WM_MOTION_Enable(int OnOff);
```

#### Parameters

Parameter	Description
OnOff	1 for enabling motion support, 0 for disabling it.

### 7.1.8.3.2 WM\_MOTION\_SetDeceleration()

#### Description

Can be used to set the deceleration of the current moving operation.

#### Prototype

```
void WM_MOTION_SetDeceleration(WM_HWIN hWin,  
                               int      Axis,  
                               I32     Deceleration);
```

#### Parameters

Parameter	Description
<a href="#">hWin</a>	Window handle.
<a href="#">Axis</a>	Desired axis. See <a href="#">Axis values</a> on page 440 for valid values.
<a href="#">Deceleration</a>	<a href="#">Deceleration</a> in pixel / (s * s)

#### Additional information

Makes only sense if the given window is already moving.

### 7.1.8.3.3 WM\_MOTION\_SetDefaultPeriod()

#### Description

Sets the default value to be used for the duration of the deceleration phase after the PID has been released. If the window is already moving the window decelerates its motion until it stops. If the window is not moving but snapping is used the window moves within that period to the next raster position. If the window is already moving and snapping is used the window decelerates its motion until it stops to the nearest raster position given by the current speed.

#### Prototype

```
unsigned WM_MOTION_SetDefaultPeriod(unsigned Period);
```

#### Parameters

Parameter	Description
<code>Period</code>	<code>Period</code> to be used.

#### Return value

Previous default value of the period.

### 7.1.8.3.4 WM\_MOTION\_SetMotion()

#### Description

Starts a moving operation with the given speed and deceleration.

#### Prototype

```
void WM_MOTION_SetMotion(WM_HWIN hWin,  
                          int      Axis,  
                          I32      Speed,  
                          I32      Deceleration);
```

#### Parameters

Parameter	Description
<a href="#">hWin</a>	Window handle.
<a href="#">Axis</a>	Desired axis. See <a href="#">Axis values</a> on page 440 for valid values.
<a href="#">Speed</a>	<a href="#">Speed</a> to be used.
<a href="#">Deceleration</a>	<a href="#">Deceleration</a> to be used.

#### Return value

Previous default value of the period.

#### Additional information

The moving operation then can be affected by further motion functions.

### 7.1.8.3.5 WM\_MOTION\_SetMoveable()

#### Description

Enables movability of the given window.

#### Prototype

```
void WM_MOTION_SetMoveable(WM_HWIN hWin,
                           U32     Flags,
                           int     OnOff);
```

#### Parameters

Parameter	Description
<code>hWin</code>	Window handle.
<code>Flags</code>	Permitted values are listed under <i>Motion flags</i> on page 1139.
<code>OnOff</code>	1 for enabling, 0 for disabling.

Permitted values for parameter <code>Flags</code>	
<code>WM_CF_MOTION_R</code>	Enables circular movability for objects within the window.
<code>WM_CF_MOTION_X</code>	Enables / disables movability for the X axis.
<code>WM_CF_MOTION_Y</code>	Enables / disables movability for the Y axis.

#### Additional information

Motion support of a window can also be set with creation flags when creating the window or within the callback routine of the window. Details can be found in the section *Motion support*.



### 7.1.8.3.6 WM\_MOTION\_SetMovement()

#### Description

Starts a moving operation with the given speed for the given distance.

#### Prototype

```
void WM_MOTION_SetMovement (WM_HWIN hWin,  
                             int      Axis,  
                             I32      Speed,  
                             I32      Dist);
```

#### Parameters

Parameter	Description
<a href="#">hWin</a>	Window handle.
<a href="#">Axis</a>	Desired axis. See <a href="#">Axis values</a> on page 440 for valid values.
<a href="#">Speed</a>	<a href="#">Speed</a> in pixels / s to be used. Positive and negative values are supported.
<a href="#">Dist</a>	Distance to be used. Needs to be a positive value.

#### Additional information

The moving operation stops automatically if the given distance is reached.

### 7.1.8.3.7 WM\_MOTION\_SetSpeed()

#### Description

Starts moving the given window with the given speed.

#### Prototype

```
void WM_MOTION_SetSpeed(WM_HWIN hWin,  
                        int      Axis,  
                        I32      Speed);
```

#### Parameters

Parameter	Description
<a href="#">hWin</a>	Window handle.
<a href="#">Axis</a>	Desired axis. See <a href="#">Axis values</a> on page 440 for valid values.
<a href="#">Speed</a>	<a href="#">Speed</a> in pixels / s to be used.

### 7.1.8.3.8 WM\_MOTION\_SetThreshold()

#### Description

Sets the number of pixels required for starting a move operation. When holding down a finger on a touchscreen the touch controller normally generates a lot of input containing different coordinates. The threshold value can be used to avoid moving in that case.

#### Prototype

```
void WM_MOTION_SetThreshold(unsigned Threshold);
```

#### Parameters

Parameter	Description
<a href="#">hWin</a>	Window handle.
<a href="#">Axis</a>	Desired axis. See <a href="#">Axis values</a> on page 440 for valid values.
<a href="#">Speed</a>	<a href="#">Speed</a> in pixels / s to be used.

## 7.1.8.4 ToolTip related functions

In addition to the introduction at the beginning of the chapter the following contains the detailed descriptions of the ToolTip related functions.

### 7.1.8.4.1 WM\_TOOLTIP\_AddTool()

#### Description

Adds a tool to an existing ToolTip object.

#### Prototype

```
int WM_TOOLTIP_AddTool(      WM_TOOLTIP_HANDLE  hToolTip,
                           WM_HWIN           hTool,
                           const char        * pText);
```

#### Parameters

Parameter	Description
<code>hToolTip</code>	Handle of ToolTip object.
<code>hTool</code>	Handle of tool window.
<code>pText</code>	Pointer to a string.

#### Return value

= 0      on success  
 ≠ 0      on error.

#### Additional information

This function can be used for adding tools by passing the window Id and a string pointer. The given string is copied into the dynamic memory of emWin and does not need to remain valid.

### 7.1.8.4.2 WM\_TOOLTIP\_Create()

#### Description

Creates a ToolTip object for the given dialog.

#### Prototype

```
WM_TOOLTIP_HANDLE WM_TOOLTIP_Create(          WM_HWIN          hDlg,
                                             const TOOLTIP_INFO * pInfo,
                                             unsigned          NumItems);
```

#### Parameters

Parameter	Description
<code>hDlg</code>	Handle of the dialog containing the tools as child- or grand child windows.
<code>pInfo</code>	Pointer to an array of <code>TOOLTIP_INFO</code> structures. Can be <code>NULL</code> .
<code>NumItems</code>	Number of tools to be added.

#### Return value

Handle to the ToolTip object on success, 0 on failure.

#### Additional information

If one of the parameters `pInfo` or `NumItems` is 0 the function only creates the ToolTip object. It is the responsibility of the application to delete the object if it is no longer used.

### 7.1.8.4.3 WM\_TOOLTIP\_Delete()

#### Description

Deletes the given ToolTip object.

#### Prototype

```
void WM_TOOLTIP_Delete(WM_TOOLTIP_HANDLE hToolTip);
```

#### Parameters

Parameter	Description
<a href="#">hToolTip</a>	Handle of ToolTip object to be deleted.

#### 7.1.8.4.4 WM\_TOOLTIP\_SetDefaultColor()

##### Description

Sets the default colors to be used for drawing ToolTips.

##### Prototype

```
GUI_COLOR WM_TOOLTIP_SetDefaultColor(unsigned Index,  
                                     GUI_COLOR Color);
```

##### Parameters

Parameter	Description
<a href="#">Index</a>	See <i>ToolTip color indexes</i> on page 1144 for a list of possible values.
<a href="#">Color</a>	Default color to be used.

##### Return value

Previous used color.

#### 7.1.8.4.5 WM\_TOOLTIP\_SetDefaultFont()

##### Description

Sets the font to be used for displaying the text of ToolTips.

##### Prototype

```
GUI_FONT *WM_TOOLTIP_SetDefaultFont(const GUI_FONT * pFont);
```

##### Parameters

Parameter	Description
<code>pFont</code>	Font to be used.

##### Return value

Previous default font used for ToolTips.



#### 7.1.8.4.6 WM\_TOOLTIP\_SetDefaultPeriod()

##### Description

Sets the default periods to be used for showing ToolTips.

##### Prototype

```
unsigned WM_TOOLTIP_SetDefaultPeriod(unsigned Index,  
                                     unsigned Period);
```

##### Parameters

Parameter	Description
<a href="#">Index</a>	See <i>ToolTip period indexes</i> on page 1145 for a list of possible values.
<a href="#">Period</a>	<a href="#">Period</a> to be used.

##### Return value

Previously used value.

## 7.1.8.5 Multiple Buffering support

### 7.1.8.5.1 WM\_MULTIBUF\_Enable()

#### Description

This function enables or disables the automatic use of Multiple Buffering by the Window Manager.

#### Prototype

```
int WM_MULTIBUF_Enable(int OnOff);
```

#### Parameters

Parameter	Description
OnOff	1 to enable the automatic use of multiple buffers. 0 to disable the automatic use of multiple buffers.

#### Return value

Previous state.

#### Additional information

Detailed information on how to use Multiple Buffering can be found in the chapter *Multiple Buffering* on page 869.

## 7.1.8.6 Memory Device support (optional)

When a Memory Device is used for redrawing a window, all drawing operations are automatically routed to a Memory Device context and are executed in memory. Only after all drawing operations have been carried out is the window redrawn on the LCD, reflecting all updates at once. The advantage of using Memory Devices is that any flickering effects (which normally occur when the screen is continuously updated as drawing operations are executed) are eliminated.

For more information on how Memory Devices operate, see the chapter *Memory Devices* on page 2916.

### 7.1.8.6.1 WM\_DisableMemdev()

#### Description

Disables the use of Memory Devices for redrawing a window.

#### Prototype

```
void WM_DisableMemdev(WM_HWIN hWin);
```

#### Parameters

Parameter	Description
<code>hWin</code>	Window handle.

### 7.1.8.6.2 WM\_EnableMemdev()

#### Description

Enables the use of Memory Devices for redrawing a window.

#### Prototype

```
void WM_EnableMemdev(WM_HWIN hWin);
```

#### Parameters

Parameter	Description
<code>hWin</code>	Window handle.

## 7.1.8.7 Timer related

### 7.1.8.7.1 WM\_CreateTimer()

#### Description

Creates a timer which sends a message to the given window after the given time period has expired. The timer is associated to the given window.

#### Prototype

```
WM_HTIMER WM_CreateTimer(WM_HWIN hWin,
                          int      UserId,
                          int      Period,
                          int      Mode);
```

#### Parameters

Parameter	Description
<code>hWin</code>	Handle of window to be informed.
<code>UserId</code>	User defined Id. Can be set to 0 if not using multiple timers for the same window.
<code>Period</code>	Time period after which the given window should receive a message.
<code>Mode</code>	(reserved for future use, should be 0)

#### Return value

Handle of the timer.

#### Additional information

The function creates a 'one shot timer' which sends a `WM_TIMER` message to the given window. After the timer period has expired the timer object remains valid and can be restarted using the function `WM_RestartTimer()` or deleted with `WM_DeleteTimer()`. Once a window is deleted the Window Manager automatically deletes all timers associated to the window.

#### Example

```
static void _cbWin(WM_MESSAGE * pMsg) {
    switch (pMsg->MsgId) {
        case WM_TIMER:
            /*
             * ... do something ...
             */
            WM_RestartTimer(pMsg->Data.v, 1000);
            break;
        default:
            WM_DefaultProc(pMsg);
    }
}
static void _DemoTimer(void) {
    WM_HWIN hWin;
    WM_HTIMER hTimer;
    hWin = WM_CreateWindow(10, 10, 100, 100, WM_CF_SHOW, _cbWin, 0);
    hTimer = WM_CreateTimer(hWin, 0, 1000, 0);
    while (1) {
        GUI_Exec();
    }
}
```

### 7.1.8.7.2 WM\_DeleteTimer()

#### Description

Deletes the given timer.

#### Prototype

```
void WM_DeleteTimer(WM_HTIMER hTimer);
```

#### Parameters

Parameter	Description
<code>hTimer</code>	Handle of the timer to be deleted.

#### Additional information

After a timer has expired the timer object remains valid and will not be deleted automatically. If it is not used anymore it should be deleted using this function. Once a window is deleted the Window Manager automatically deletes all timers associated to the window.

### 7.1.8.7.3 WM\_GetTimerId()

#### Description

Gets the Id of the given timer.

#### Prototype

```
int WM_GetTimerId(WM_HTIMER hTimer);
```

#### Parameters

Parameter	Description
<code>hTimer</code>	Handle of the timer.

#### Return value

The Id of the timer which was previously set within the function `WM_CreateTimer()`.

#### 7.1.8.7.4 WM\_RestartTimer()

##### Description

Restarts the given timer with the given period.

##### Prototype

```
void WM_RestartTimer(WM_HTIMER hTimer,  
                    int Period);
```

##### Parameters

Parameter	Description
<code>hTimer</code>	Handle of the timer to be restarted.
<code>Period</code>	New period to be used.

##### Additional information

If this function gets called with `Period` set to zero the timer gets restarted with the period set on creation. After the period has expired a `WM_TIMER` message will be sent to the window assigned to the timer. For details, refer to `WM_CreateTimer()`.



## 7.1.8.8 Widget related functions

### 7.1.8.8.1 WM\_GetClientWindow()

#### Description

Returns the handle of the client window. The function sends a message to the active window to retrieve the handle of the client window. If the window does not handle the message the handle of the current window will be returned.

#### Prototype

```
WM_HWIN WM_GetClientWindow(WM_HWIN hObj);
```

#### Parameters

Parameter	Description
<code>hWin</code>	Handle of widget.

#### Return value

Handle of the client window.

#### Additional information

Use this function to retrieve the client window handle of a FRAMEWIN widget.

### 7.1.8.8.2 WM\_GetContentRect()

#### Description

Returns the content rectangle of the current window. The rectangle is in client coordinates. The content rectangle of a window is the area that shows the actual content. For example for a LISTVIEW widget the content rectangle is the inside rectangle without its attached HEADER widget. For most widgets, it is the inside rectangle.

#### Prototype

```
void WM_GetContentRect(GUI_RECT * pRect);
```

#### Parameters

Parameter	Description
<code>pRect</code>	<code>out</code> Pointer to a GUI_RECT structure.

### 7.1.8.8.3 WM\_GetContentRectEx()

#### Description

Returns the content rectangle of a given window. The rectangle is in client coordinates.

The content rectangle of a window is the area that shows the actual content. For example for a LISTVIEW widget the content rectangle is the inside rectangle without its attached HEADER widget. For most widgets, it is the inside rectangle.

#### Prototype

```
void WM_GetContentRectEx(WM_HWIN hWin,  
                        GUI_RECT * pRect);
```

#### Parameters

Parameter	Description
<code>hWin</code>	Window handle.
<code>pRect</code>	<b>out</b> Pointer to a GUI_RECT structure.

#### 7.1.8.8.4 WM\_GetId()

##### Description

Returns the ID of a specified widget window.

##### Prototype

```
int WM_GetId(WM_HWIN hObj);
```

##### Parameters

Parameter	Description
<code>hObj</code>	Handle of widget.

##### Return value

> 0 ID of the widget which was specified at creation or set using `WM_SetId()`.  
= 0 will be returned if the specified window is not a widget.

### 7.1.8.8.5 WM\_GetInsideRect()

#### Description

Returns the coordinates of the client area of the active widget less the border size. The function sends a message to the active window to retrieve the inside rectangle. If the widget does not handle the message (that means the widget has no border) `WM_GetClientRect` will be used to calculate the rectangle. The result is given in window coordinates. That means `x0` and `y0` of the `GUI_RECT` structure corresponds to the border size in `x` and `y`, `x1` and `y1` corresponds to the size of the window less the border size - 1.

This function sends the `WM_GET_INSIDE_RECT` message to the given window which should be filled by the user. This message is quite helpful when creating an own widget.

#### Prototype

```
void WM_GetInsideRect(GUI_RECT * pRect);
```

#### Parameters

Parameter	Description
<code>pRect</code>	Pointer to a <code>GUI_RECT</code> structure.

### 7.1.8.8.6 WM\_GetInsideRectEx()

#### Description

Returns the coordinates of a window less the border size.

#### Prototype

```
void WM_GetInsideRectEx(WM_HWIN    hWin,  
                       GUI_RECT * pRect);
```

#### Parameters

Parameter	Description
<code>hObj</code>	Handle of widget.
<code>pRect</code>	Pointer to a GUI_RECT structure.

#### Additional information

For details, refer to `WM_GetInsideRect()`.

### 7.1.8.8.7 WM\_GetScrollbarH()

#### Description

If the given window has a horizontal SCROLLBAR attached the function returns the handle of that SCROLLBAR.

#### Prototype

```
WM_HWIN WM_GetScrollbarH(WM_HWIN hWin);
```

#### Parameters

Parameter	Description
<code>hWin</code>	Handle of a window which has a horizontal SCROLLBAR attached.

#### Return value

- ≠ 0 Handle of the horizontal SCROLLER widget.
- = 0 If no horizontal SCROLLBAR widget is attached.

#### Additional information

Additional information can be found in *SCROLLBAR: Scroll bar widget* on page 2183.

### 7.1.8.8.8 WM\_GetScrollbarV()

#### Description

If the given window has a vertical SCROLLBAR attached the function returns the handle of that SCROLLBAR.

#### Prototype

```
WM_HWIN WM_GetScrollbarV(WM_HWIN hWin);
```

#### Parameters

Parameter	Description
<code>hWin</code>	Handle of a window which has a vertical SCROLLBAR attached.

#### Return value

≠ 0     Handle of the vertical SCROLLER widget.  
= 0     If no vertical SCROLLBAR widget is attached.

#### Additional information

Additional information can be found in *SCROLLBAR: Scroll bar widget* on page 2183.



### 7.1.8.8.9 WM\_GetScrollerV()

#### Description

If the given window has a vertical SCROLLER attached the function returns the handle of that SCROLLER.

#### Prototype

```
WM_HWIN WM_GetScrollerV(WM_HWIN hWin);
```

#### Parameters

Parameter	Description
<a href="#">hWin</a>	Handle of a window which has a vertical SCROLLER attached.

#### Return value

- ≠ 0     Handle of the vertical SCROLLER widget.
- = 0     If no vertical SCROLLER widget is attached.

#### Additional information

Additional information can be found in *SCROLLER: Scroll widget* on page 2215.

### 7.1.8.8.10 WM\_GetScrollerH()

#### Description

If the given window has a horizontal SCROLLER attached the function returns the handle of that SCROLLER.

#### Prototype

```
WM_HWIN WM_GetScrollerH(WM_HWIN hWin);
```

#### Parameters

Parameter	Description
<code>hWin</code>	Handle of a window which has a horizontal SCROLLER attached.

#### Return value

- ≠ 0     Handle of the horizontal SCROLLER widget.
- = 0     If no horizontal SCROLLER widget is attached.

#### Additional information

Additional information can be found in *SCROLLER: Scroll widget* on page 2215.

### 7.1.8.8.11 WM\_GetScrollPartner()

#### Description

Returns the scroll partner of a given SCROLLBAR or SCROLLER handle. For example, for a horizontal SCROLLBAR/SCROLLER its scroll partner would be its vertical counterpart.

#### Prototype

```
WM_HWIN WM_GetScrollPartner(WM_HWIN hScroll);
```

#### Parameters

Parameter	Description
<a href="#">hScroll</a>	Handle to a SCROLLER or SCROLLBAR widget.

#### Return value

- = 0 No scroll partner available.
- ≠ 0 Scroll partner of given SCROLLER or SCROLLBAR.

### 7.1.8.8.12 WM\_GetScrollPosH()

#### Description

Returns the horizontal scrolling position of a window.

#### Prototype

```
int WM_GetScrollPosH(WM_HWIN hWin);
```

#### Parameters

Parameter	Description
<code>hWin</code>	Handle of a window which has a horizontal SCROLLBAR attached.

#### Return value

Position of the horizontal SCROLLBAR widget ( $0 < n$ )  
0, if no horizontal SCROLLBAR widget is attached.

#### Additional information

Additional information can be found in *SCROLLBAR: Scroll bar widget* on page 2183.

### 7.1.8.8.13 WM\_GetScrollPosV()

#### Description

Returns the vertical scrolling position of a window.

#### Prototype

```
int WM_GetScrollPosV(WM_HWIN hWin);
```

#### Parameters

Parameter	Description
<code>hWin</code>	Handle of a window which has a horizontal SCROLLBAR attached.

#### Return value

Position of the horizontal SCROLLBAR widget ( $0 < n$ )  
0, if no horizontal SCROLLBAR widget is attached.

#### Additional information

Additional information can be found in *SCROLLBAR: Scroll bar widget* on page 2183.

#### 7.1.8.8.14 WM\_GetScrollState()

##### Description

Fills a data structure with information of the current state of a specified SCROLLBAR widget.

##### Prototype

```
void WM_GetScrollState(WM_HWIN      hObj,  
                      WM_SCROLL_STATE * pScrollState);
```

##### Parameters

Parameter	Description
<code>hObj</code>	Handle of scroll bar widget.
<code>pScrollState</code>	Pointer to a data structure of type <code>WM_SCROLL_STATE</code> .

##### Additional information

This function does not return since the state of a scroll bar is defined by more than one value.

It has no effect on other types of widgets or windows. Additional information can be found in *SCROLLBAR: Scroll bar widget* on page 2183.

### 7.1.8.8.15 WM\_SetScrollPosH()

#### Description

Sets the horizontal scrolling position of a window.

#### Prototype

```
void WM_SetScrollPosH(WM_HWIN hWin,  
                     unsigned ScrollPos);
```

#### Parameters

Parameter	Description
<code>hWin</code>	Handle of a window which has a horizontal SCROLLBAR attached.
<code>ScrollPos</code>	New scroll position of the scroll bar.

#### Additional information

Additional information can be found in *SCROLLBAR: Scroll bar widget* on page 2183.

### 7.1.8.8.16 WM\_SetScrollPosV()

#### Description

Sets the vertical scrolling position of a window.

#### Prototype

```
void WM_SetScrollPosV(WM_HWIN hWin,  
                     unsigned ScrollPos);
```

#### Parameters

Parameter	Description
<code>hWin</code>	Handle of a window which has a vertical SCROLLBAR attached.
<code>ScrollPos</code>	New scroll position of the scroll bar.

#### Additional information

Additional information can be found in *SCROLLBAR: Scroll bar widget* on page 2183.



### 7.1.8.8.17 WM\_SetScrollState()

#### Description

Sets the state of a specified SCROLLBAR widget.

#### Prototype

```
void WM_SetScrollState(      WM_HWIN      hWin,  
                           const WM_SCROLL_STATE * pState);
```

#### Parameters

Parameter	Description
<a href="#">hObj</a>	Handle of scroll bar widget.

## 7.1.8.9 Data structures

### 7.1.8.9.1 TOOLTIP\_INFO

#### Description

Contains the information about a ToolTip.

#### Type definition

```
typedef struct {  
    int      Id;  
    const char * pText;  
} TOOLTIP_INFO;
```

#### Structure members

Member	Description
<a href="#">Id</a>	<a href="#">Id</a> of the ToolTip.
<a href="#">pText</a>	String containing the text of the ToolTip.

### 7.1.8.9.2 WM\_KEY\_INFO

#### Description

Contains information about a pressed key.

#### Type definition

```
typedef struct {  
    int Key;  
    int PressedCnt;  
} WM_KEY_INFO;
```

#### Structure members

Member	Description
<a href="#">Key</a>	The key which has been pressed.
<a href="#">PressedCnt</a>	
> 0	if the key has been pressed, 0 if the key has been released.

### 7.1.8.9.3 WM\_MESSAGE

#### Description

Contains the data for a message sent by a window.

#### Type definition

```
typedef struct {
    int          MsgId;
    WM_HWIN     hWin;
    WM_HWIN     hWinSrc;
    union {
        const void * p;
        int          v;
        GUI_COLOR   Color;
        void         (* pFunc)(void);
    } Data;
} WM_MESSAGE;
```

#### Structure members

Member	Description
<a href="#">MsgId</a>	Type of message.
<a href="#">hWin</a>	Destination window.
<a href="#">hWinSrc</a>	Source window.
<a href="#">Data</a>	Data union. See elements below.
Elements of Data	
<a href="#">p</a>	Message-specific data pointer.
<a href="#">v</a>	Message-specific data value.
<a href="#">Color</a>	Message-specific color.
<a href="#">pFunc</a>	Message-specific function pointer.

### 7.1.8.9.4 WM\_MOTION\_INFO

#### Description

Contains information about a move with motion support.

#### Type definition

```
typedef struct {
    U8          Cmd;
    U8          FinalMove;
    U8          StopMotion;
    U8          IsDragging;
    int         dx;
    int         dy;
    int         da;
    int         xPos;
    int         yPos;
    int         Period;
    int         SnapX;
    int         SnapY;
    U8          IsOutside;
    unsigned    Overlap;
    U32         Flags;
    GUI_PID_STATE * pState;
    GUI_HMEM    hContext;
    int         Dest;
} WM_MOTION_INFO;
```

#### Structure members

Member	Description
<code>Cmd</code>	Command. See <i>Motion messages</i> on page 1140.
<code>FinalMove</code>	Set to 1 on the final moving operation.
<code>StopMotion</code>	Can be set to 1 to stop motion immediately.
<code>IsDragging</code>	Is set to 1 if the PID is pressed, 0 if released.
<code>dx</code>	Distance in X to be used to move the window.
<code>dy</code>	Distance in Y to be used to move the window.
<code>da</code>	Distance in 1/10 degrees to be used to move an item.
<code>xPos</code>	Used to return the current position in X for custom moving operations.
<code>yPos</code>	Used to return the current position in Y for custom moving operations.
<code>Period</code>	Duration of the moving operation after the PID has been released.
<code>SnapX</code>	Raster size in X for snapping operations, 0 if no snapping is required.
<code>SnapY</code>	Raster size in Y for snapping operations, 0 if no snapping is required.
<code>IsOutside</code>	If motion is managed by window.
<code>Overlap</code>	Overlapping distance allowed for dragging operations.
<code>Flags</code>	To be used to enable motion support.
<code>pState</code>	Internal use.
<code>hContext</code>	Internal use.
<code>Dest</code>	Internal use.

### 7.1.8.9.5 WM\_MOVE\_INFO

#### Description

Stores the distance of a window move operation.

#### Type definition

```
typedef struct {  
    int dx;  
    int dy;  
} WM_MOVE_INFO;
```

#### Structure members

Member	Description
<a href="#">dx</a>	Difference between old and new position on the X-axis.
<a href="#">dy</a>	Difference between old and new position on the Y-axis.

### 7.1.8.9.6 WM\_PID\_STATE\_CHANGED\_INFO

#### Description

Information about the changed PID state. Sent to a window with the WM\_PID\_STATE\_CHANGED message.

#### Type definition

```
typedef struct {  
    int x;  
    int y;  
    U8 State;  
    U8 StatePrev;  
} WM_PID_STATE_CHANGED_INFO;
```

#### Structure members

Member	Description
<code>x</code>	Horizontal position of the PID in window coordinates.
<code>y</code>	Vertical position of the PID in window coordinates.
<code>State</code>	Pressed state (> 0 if PID is pressed).
<code>StatePrev</code>	Previous pressed state.

### 7.1.8.9.7 WM\_SCROLL\_STATE

#### Description

Saves the scrollstate of a scrollbar.

#### Type definition

```
typedef struct {  
    int NumItems;  
    int v;  
    int PageSize;  
} WM_SCROLL_STATE;
```

#### Structure members

Member	Description
<a href="#">NumItems</a>	Number of items.
<a href="#">v</a>	Current value.
<a href="#">PageSize</a>	Number of items visible on one page.



## 7.1.8.10 Defines

### 7.1.8.10.1 Message IDs

#### Description

List of all messages sent by the Window Manager. The member `MsgId` of the `WM_MESSAGE` structure contains one of these values to identify a message.

#### Definition

```
#define WM_CREATE          0x0001
#define WM_MOVE           0x0003
#define WM_SIZE           0x0005
#define WM_DELETE        11
#define WM_TOUCH         0x0240
#define WM_TOUCH_CHILD   13
#define WM_KEY           14
#define WM_PAINT         0x000F
#define WM_MOUSEOVER     16
#define WM_MOUSEOVER_END 18
#define WM_PID_STATE_CHANGED 17
#define WM_GET_INSIDE_RECT 20
#define WM_GET_ID        21
#define WM_SET_ID        22
#define WM_INIT_DIALOG   29
#define WM_SET_FOCUS     30
#define WM_GET_ACCEPT_FOCUS 31
#define WM_NOTIFY_PARENT 38
#define WM_NOTIFY_VIS_CHANGED 41
#define WM_PRE_PAINT     46
#define WM_POST_PAINT    47
#define WM_MOTION        48
#define WM_USER_DATA     52
#define WM_SET_CALLBACK  53
#define WM_TIMER         0x0113
#define WM_USER          0x0400
```

#### Symbols

Definition	Description
<a href="#">WM_CREATE</a>	Sent immediately after a window has been created, giving the window the chance to initialize and create any child windows.
<a href="#">WM_MOVE</a>	Sent to a window immediately after it has been moved.
<a href="#">WM_SIZE</a>	Sent to a window after its size has changed.
<a href="#">WM_DELETE</a>	Sent just before a window is deleted, telling the window to free its data structures (if any).
<a href="#">WM_TOUCH</a>	Sent to a window once a pointer input device is pressed, pressed and moved or released over its area.
<a href="#">WM_TOUCH_CHILD</a>	Sent to a parent window if a child window has been touched by the pointer input device.
<a href="#">WM_KEY</a>	Sent to the window currently containing the focus if a key has been pressed.
<a href="#">WM_PAINT</a>	Sent to a window after it has become invalid and it should be redrawn.
<a href="#">WM_MOUSEOVER</a>	Sent to a window if a pointer input device touches the outline of a window. Only sent if mouse support is enabled.

Definition	Description
WM_MOUSEOVER_END	Sent to a window if a pointer input device has been moved out of the outline of a window. Only sent if mouse support is enabled.
WM_PID_STATE_CHANGED	Sent to the window pointed by the pointer input device when the pressed state has been changed.
WM_GET_INSIDE_RECT	Sent to a window to get the client rectangle without the effect size.
WM_GET_ID	Sent to a window to request the Id of the window.
WM_SET_ID	Sent to a window to change the window Id.
WM_INIT_DIALOG	Sent to a dialog window immediately after the creation of the dialog.
WM_SET_FOCUS	Sent to a window if it gains or loses the input focus.
WM_GET_ACCEPT_FOCUS	Sent to a window to determine if the window is able to receive the input focus.
WM_NOTIFY_PARENT	Informs a parent window that something has occurred in one of its child windows. The information is detailed as a notification code.
WM_NOTIFY_VIS_CHANGED	Sent to a window if its visibility has been changed.
WM_PRE_PAINT	Sent to a window before the first WM_PAINT message is sent.
WM_POST_PAINT	Sent to a window after the last WM_PAINT message was processed.
WM_MOTION	Sent to a window to achieve advanced motion support.
WM_USER_DATA	Sent to a window after user data has been set.
WM_SET_CALLBACK	Sent to a window after a callback has been set.
WM_TIMER	Sent to a window after a timer has expired.
WM_USER	The WM_USER constant can be used by applications to define private messages, usually of the form (WM_USER + X), where X is an integer value.

### Additional information

WM\_MOTION, WM\_MOUSEOVER, WM\_MOUSEOVER\_END, WM\_PID\_STATE\_CHANGED, WM\_TOUCH and WM\_TOUCH\_CHILD are "Pointer input device (PID) messages".

### 7.1.8.10.2 Motion flags

#### Description

Flags for motion support. The flags are supposed to be OR-combined with the member Flags of the WM\_MOTION\_INFO structure.

#### Definition

```
#define WM_MOTION_MANAGE_BY_WINDOW    (1 << 0)
```

#### Symbols

Definition	Description
WM_MOTION_MANAGE_BY_WINDOW	Window movement is managed by window itself.

### 7.1.8.10.3 Motion messages

#### Description

Commands sent with a `WM_MOTION` message. The command can be found in the member `Cmd` of the `WM_MOTION_INFO` structure.

#### Definition

```
#define WM_MOTION_INIT          0
#define WM_MOTION_MOVE         1
#define WM_MOTION_GETPOS       2
#define WM_MOTION_GETCONTEXT   3
#define WM_MOTION_GETDEST      4
#define WM_MOTION_GETSNAP      5
#define WM_MOTION_SETCONTEXT   6
```

#### Symbols

Definition	Description
<a href="#">WM_MOTION_INIT</a>	Sent to a window to initiate a motion operation.
<a href="#">WM_MOTION_MOVE</a>	Sent to a window to achieve custom moving operations.
<a href="#">WM_MOTION_GETPOS</a>	Sent to get the current position of custom moving operations.
<a href="#">WM_MOTION_GETCONTEXT</a>	Internal use.
<a href="#">WM_MOTION_GETDEST</a>	Sent to receive the desired position to move to
<a href="#">WM_MOTION_GETSNAP</a>	Sent to receive the nearest snap position
<a href="#">WM_MOTION_SETCONTEXT</a>	Internal use.

#### Additional information

More information about these commands can be read under *WM\_MOTION message and WM\_MOTION\_INFO* on page 970.

### 7.1.8.10.4 Motion overlap flags

#### Description

Flags for setting overlap behavior of widgets. The overlap will come into effect if a distance has been set.

#### Definition

```
#define WM_MOTION_OVERLAP_TOP      (1 << 4)
#define WM_MOTION_OVERLAP_BOTTOM  (1 << 5)
#define WM_MOTION_OVERLAP_LEFT    (1 << 6)
#define WM_MOTION_OVERLAP_RIGHT   (1 << 7)
```

#### Symbols

Definition	Description
<a href="#">WM_MOTION_OVERLAP_TOP</a>	Overlap will be active at the top edge of the widget.
<a href="#">WM_MOTION_OVERLAP_BOTTOM</a>	Overlap will be active at the bottom edge of the widget.
<a href="#">WM_MOTION_OVERLAP_LEFT</a>	Overlap will be active at the left edge of the widget.
<a href="#">WM_MOTION_OVERLAP_RIGHT</a>	Overlap will be active at the right edge of the widget.

### 7.1.8.10.5 Notification codes

#### Description

List of all notifications sent by the Window Manager. A notification code is sent with a WM\_NOTIFY\_PARENT message and can be read with `pMsg->Data.v`.

#### Definition

```
#define WM_NOTIFICATION_CLICKED          1
#define WM_NOTIFICATION_RELEASED        2
#define WM_NOTIFICATION_MOVED_OUT       3
#define WM_NOTIFICATION_SEL_CHANGED     4
#define WM_NOTIFICATION_VALUE_CHANGED   5
#define WM_NOTIFICATION_SCROLLBAR_ADDED 6
#define WM_NOTIFICATION_CHILD_DELETED    7
#define WM_NOTIFICATION_GOT_FOCUS       8
#define WM_NOTIFICATION_LOST_FOCUS      9
#define WM_NOTIFICATION_SCROLL_CHANGED  10
#define WM_NOTIFICATION_SCROLLER_ADDED  16
#define WM_NOTIFICATION_OVERLAP_TOP_ENTERED 17
#define WM_NOTIFICATION_OVERLAP_BOTTOM_ENTERED 18
#define WM_NOTIFICATION_OVERLAP_LEFT_ENTERED 19
#define WM_NOTIFICATION_OVERLAP_RIGHT_ENTERED 20
#define WM_NOTIFICATION_OVERLAP_RELEASED 21
#define WM_NOTIFICATION_STARTED         22
#define WM_NOTIFICATION_STOPPED         23
```

#### Symbols

Definition	Description
WM_NOTIFICATION_CLICKED	This notification message will be sent when the window has been clicked.
WM_NOTIFICATION_RELEASED	This notification message will be sent when a clicked widget has been released.
WM_NOTIFICATION_MOVED_OUT	This notification message will be sent when the pointer was moved out of the window while it is clicked.
WM_NOTIFICATION_SEL_CHANGED	This notification message will be sent when the selection of a widget has changed.
WM_NOTIFICATION_VALUE_CHANGED	This notification message will be sent when a widget specific value has changed.
WM_NOTIFICATION_SCROLLBAR_ADDED	This notification message will be sent when a SCROLLBAR widget has been added to the window.
WM_NOTIFICATION_CHILD_DELETED	This notification message will be sent from a window to its parent before it is deleted.
WM_NOTIFICATION_GOT_FOCUS	This notification message will be sent once a window receives and accepts the focus.
WM_NOTIFICATION_LOST_FOCUS	This notification message will be sent when the window has lost the focus.
WM_NOTIFICATION_SCROLL_CHANGED	This notification message will be sent when the scroll position of an attached SCROLLBAR widget has changed.
WM_NOTIFICATION_SCROLLER_ADDED	This notification message will be sent when a SCROLLER widget has been added to the window.
WM_NOTIFICATION_OVERLAP_TOP_ENTERED	This notification message will be sent when the top overlap area of a widget was entered.
WM_NOTIFICATION_OVERLAP_BOTTOM_ENTERED	This notification message will be sent when the bottom overlap area of a widget was entered.

Definition	Description
WM_NOTIFICATION_OVERLAP_LEFT_ENTERED	This notification message will be sent when the left overlap area of a widget was entered.
WM_NOTIFICATION_OVERLAP_RIGHT_ENTERED	This notification message will be sent when the right overlap area of a widget was entered.
WM_NOTIFICATION_OVERLAP_RELEASED	This notification message will be sent when the overlap area of a widget was entered and has been released.
WM_NOTIFICATION_STARTED	This notification message will be sent when a widget has been started.
WM_NOTIFICATION_STOPPED	This notification message will be sent when a widget has been stopped.

### 7.1.8.10.6 ToolTip color indexes

#### Description

Color indexes for ToolTip related routines.

#### Definition

```
#define WM_TOOLTIP_CI_BK      0
#define WM_TOOLTIP_CI_FRAME  1
#define WM_TOOLTIP_CI_TEXT   2
```

#### Symbols

Definition	Description
<a href="#">WM_TOOLTIP_CI_BK</a>	Color to be used for the background.
<a href="#">WM_TOOLTIP_CI_FRAME</a>	Color to be used for the thin frame.
<a href="#">WM_TOOLTIP_CI_TEXT</a>	Color to be used for the text.



### 7.1.8.10.7 ToolTip period indexes

#### Description

Period indexes for ToolTip related routines.

#### Definition

```
#define WM_TOOLTIP_PI_FIRST    0
#define WM_TOOLTIP_PI_SHOW    1
#define WM_TOOLTIP_PI_NEXT    2
```

#### Symbols

Definition	Description
<a href="#">WM_TOOLTIP_PI_FIRST</a>	Period to be used the first time the PID is hovered over a tool. The ToolTip appears after the PID has not moved for at least this period. Default is 1000 ms.
<a href="#">WM_TOOLTIP_PI_SHOW</a>	Period to be used for showing the ToolTip. The ToolTip disappears after the PID remains for at least this period without moving. Default is 5000 ms.
<a href="#">WM_TOOLTIP_PI_NEXT</a>	Period to be used if the PID hovers over a tool of the same parent as before. The ToolTip appears after the PID is not moved for at least this period. Default is 50 ms.

### 7.1.8.10.8 Window create flags

#### Description

Flags that define a window upon creation. These flags can be passed to the create window function as flag-parameter. The flags are combinable using the binary OR-operator.

#### Definition

```
#define WM_CF_HASTRANS          (1UL << 0)
#define WM_CF_HIDE             (0UL << 1)
#define WM_CF_SHOW            (1UL << 1)
#define WM_CF_MEMDEV          (1UL << 2)
#define WM_CF_STAYONTOP       (1UL << 3)
#define WM_CF_DISABLED        (1UL << 4)
#define WM_CF_ACTIVATE        (1UL << 5) /* Is (re)used as WM_SF_INVALID */
#define WM_CF_FGND             (0UL << 6)
#define WM_CF_BGND            (1UL << 6)
#define WM_CF_ANCHOR_RIGHT    (1UL << 7)
#define WM_CF_ANCHOR_BOTTOM   (1UL << 8)
#define WM_CF_ANCHOR_LEFT     (1UL << 9)
#define WM_CF_ANCHOR_TOP      (1UL << 10)
#define WM_CF_CONST_OUTLINE   (1UL << 11)
#define WM_CF_LATE_CLIP       (1UL << 12)
#define WM_CF_MEMDEV_ON_REDRAW (1UL << 13)
#define WM_SF_INVALID_DRAW    (1UL << 14) /* Tells the WM to redraw the window
using the static memory device */
#define WM_SF_DELETE          (1UL << 15) /* The window will be deleted on the
next time WM_Exec() is called */
#define WM_CF_STATIC          (1UL << 16)
#define WM_CF_MOTION_X        (1UL << 17)
#define WM_CF_MOTION_Y        (1UL << 18)
#define WM_CF_GESTURE         (1UL << 19)
#define WM_CF_ZOOM            (1UL << 20)
#define WM_CF_MOTION_R        (1UL << 21)
#define WM_CF_UNTOUCHABLE     (1UL << 22)
#define WM_CF_APPWIZARD       (1UL << 23) /* Window is an AppWizard object */
#define WM_CF_MEMDEV_CLIPPING (1UL << 24)
```

#### Symbols

Definition	Description
<a href="#">WM_CF_HASTRANS</a>	Has transparency flag. Must be defined for windows whose client area is not entirely filled. To set this flag after the window has been created the function <code>WM_SetTransState()</code> should be used.
<a href="#">WM_CF_HIDE</a>	Hide window after creation (default).
<a href="#">WM_CF_SHOW</a>	Show window after creation.
<a href="#">WM_CF_MEMDEV</a>	<p>Automatically use a Memory Device for drawing. This will avoid flickering and also improve the output speed in most cases, as clipping is simplified. The Window Manager creates a Memory Device for the current window according to the configured color depth and window size. The Memory Device is deleted immediately after the drawing process was finished.</p> <p>In order to draw images into a remaining Memory Device the <code>IMAGE</code> widget can be used with the creation flag <code>IMAGE_CF_MEMDEV</code>. Details can be found in the section <i>IMAGE: Image widget</i> on page 1645. Note that the Memory Device package is required (and needs to be enabled in the configuration) in order to be able to use this flag. If Memory Devices are not enabled, this flag is ignored.</p>

Definition	Description
<a href="#">WM_CF_STAYONTOP</a>	Make sure window stays on top of all siblings created without this flag.
<a href="#">WM_CF_DISABLED</a>	Window is disabled after creation. This means it receives no PID (mouse and touch) input.
<a href="#">WM_CF_ACTIVATE</a>	Internal use.
<a href="#">WM_CF_FGND</a>	Put window in foreground after creation (default).
<a href="#">WM_CF_BGND</a>	Put window in background after creation.
<a href="#">WM_CF_ANCHOR_RIGHT</a>	Anchors the right edge of the new window relative to the right edge of the parent window. If the position of the parent windows right edge will be adjusted due to a size change, the position of new window will also be adjusted.
<a href="#">WM_CF_ANCHOR_BOTTOM</a>	Anchors the bottom edge of the new window relative to the bottom edge of the parent window. If the position of the parent windows bottom edge will be adjusted due to a size change, the position of new window will also be adjusted.
<a href="#">WM_CF_ANCHOR_LEFT</a>	Anchors the left edge of the new window relative to the left edge of the parent window (default). If the position of the parent windows left edge will be adjusted due to a size change, the position of new window will also be adjusted.
<a href="#">WM_CF_ANCHOR_TOP</a>	Anchors the top edge of the new window relative to the top edge of the parent window (default). If the position of the parent windows top edge will be adjusted due to a size change, the position of new window will also be adjusted.
<a href="#">WM_CF_CONST_OUTLINE</a>	This flag is an optimization for transparent windows. It gives the Window Manager a chance to optimize redrawing and invalidation of transparent windows. A transparent window is normally redrawn as part of the background, which is less efficient than redrawing the window separately. However, this flag may NOT be used if the window has semi transparency (alpha blending / anti-aliasing with background) or the outline (the shape) changes with the window's states. To set this flag after the window has been created the function <code>WM_SetTransState()</code> should be used.
<a href="#">WM_CF_LATE_CLIP</a>	This flag can be used to tell the WM that the clipping should be done in the drawing routines (late clipping). The default behavior of the WM is early clipping. That means that the clipping rectangle will be calculated before a <code>WM_PAINT</code> message will be sent to a window. In dependence of other existing windows it might be necessary to send more than one <code>WM_PAINT</code> message to a window. If using <a href="#">WM_CF_LATE_CLIP</a> the WM makes sure only one message will be sent to an invalid window and the clipping will be done by the drawing routines. The <code>Sample</code> folder of <code>emWin</code> contains the example <code>WM_LateClipping.c</code> to show the effect.
<a href="#">WM_CF_MEMDEV_ON_RE-DRAW</a>	Equals <a href="#">WM_CF_MEMDEV</a> with the difference that the according window is drawn the first time without using a Memory Device. The WM will automatically use a Memory Device for redrawing. This flag can be used as a replacement of <a href="#">WM_CF_MEMDEV</a> . It typically accelerates the initial rendering of the window, but maintains the advantage of flicker free updates.
<a href="#">WM_SF_INVALID_DRAW</a>	Internal use.
<a href="#">WM_SF_DELETE</a>	Internal use.

Definition	Description
<a href="#">WM_CF_STATIC</a>	A static memory device is used for drawing. That means if a window with this flag receives a <code>WM_PAINT</code> message, <code>emWin</code> first checks if a static memory device exists. If not, it will be created and the content of the window/widget will be (pre)rendered in the memory device. If such a window is moved to a new position, only the already existing memory needs to be drawn at the new position. This kind of drawing a window could improve the performance a lot, but needs a large amount of RAM.
<a href="#">WM_CF_MOTION_X</a>	Window can be moved automatically in X axis.
<a href="#">WM_CF_MOTION_Y</a>	Window can be moved automatically in Y axis.
<a href="#">WM_CF_GESTURE</a>	Marks the window to be able to receive gesture messages. This requires gesture support.
<a href="#">WM_CF_ZOOM</a>	Window can be scaled automatically by multi-touch gesture input.
<a href="#">WM_CF_MOTION_R</a>	This enables the window to be rotated.
<a href="#">WM_CF_UNTOUCHABLE</a>	A window created with this flag routes its touch input to its parent. This makes a window 'untouchable'.
<a href="#">WM_CF_APPWIZARD</a>	Internal use.
<a href="#">WM_CF_MEMDEV_CLIPPING</a>	Reactivates the window manager when drawing into memory devices created via <a href="#">WM_CF_MEMDEV</a> . Otherwise it can happen that invisible windows (e.g. a window covered completely by another window) still draws its content into a memory device but the memory device doesn't get drawn to the LCD. With this flag these unnecessary drawing operations can be avoided. Attention, if there is a non transparent window in the foreground, which is smaller than the window in the back, tiling will be used and multiple paint events into the memory device will be performed!

## 7.1.9 Example

The following example illustrates the difference between using a callback routine for re-drawing the background and not having one. It also shows how to set your own callback function. The example is available as `WM_Redraw.c` in the examples shipped with `emWin`:

```

/*****
 *          SEGGER MICROCONTROLLER SYSTEME GmbH
 *          Solutions for real time microcontroller applications
 *
 *          emWin example code
 *
 *****/
-----
File       : WM_Redraw.c
Purpose    : Demonstrates the redrawing mechanism of the Window Manager
-----
*/
#include "GUI.H"
/*****
 *
 *          Callback routine for background window
 *
 *****/
*/
static void cbBackgroundWin(WM_MESSAGE * pMsg) {
    switch (pMsg->MsgId) {
        case WM_PAINT:
            GUI_Clear();
            break;
        default:
            WM_DefaultProc(pMsg);
    }
}
/*****
 *
 *          Callback routine for foreground window
 *
 *****/
*/
static void cbForegroundWin(WM_MESSAGE * pMsg) {
    switch (pMsg->MsgId) {
        case WM_PAINT:
            GUI_SetBkColor(GUI_GREEN);
            GUI_Clear();
            GUI_DispString("Foreground window");
            break;
        default:
            WM_DefaultProc(pMsg);
    }
}
/*****
 *
 *          Demonstrates the redraw mechanism of emWin
 *
 *****/
*/
static void DemoRedraw(void) {
    GUI_HWIN hWnd;
    while(1) {
        /* Create foreground window */
        hWnd = WM_CreateWindow(10, 10, 100, 100, WM_CF_SHOW, cbForegroundWin, 0);
        /* Show foreground window */
        GUI_Delay(1000);
        /* Delete foreground window */
        WM_DeleteWindow(hWnd);
        GUI_DispStringAt("Background of window has not been redrawn", 10, 10);
    }
}

```

```
/* Wait a while, background will not be redrawn */
GUI_Delay(1000);
GUI_Clear();
/* Set callback for Background window */
WM_SetCallback(WM_HBKWIN, cbBackgroundWin);
/* Create foreground window */
hWnd = WM_CreateWindow(10, 10, 100, 100, WM_CF_SHOW, cbForegroundWin, 0);
/* Show foreground window */
GUI_Delay(1000);
/* Delete foreground window */
WM_DeleteWindow(hWnd);
/* Wait a while, background will be redrawn */
GUI_Delay(1000);
/* Delete callback for Background window */
WM_SetCallback(WM_HBKWIN, 0);
}}
/*****
*
*          main
*
*****/
*/
void main(void) {
    GUI_Init();
    DemoRedraw();
}
```

## 7.2 Widgets (window objects)

Widgets are windows with object-type properties. They are called controls in the Windows environments and make up the elements of the user interface. They can react automatically to certain events. For example, a button can appear in a different state if it is pressed. Widgets have properties which may be changed at any time during their existence. They are typically deleted as soon as they are not used any longer. Similar to windows, widgets are referenced by handles which are returned by the respective create function.











Widgets require the Window Manager. Once a widget is created, it is treated just like any other window. The WM ensures that it is properly displayed (and redrawn) whenever necessary. The use of widgets is not mandatory for applications or user interfaces, but they decrease development time.



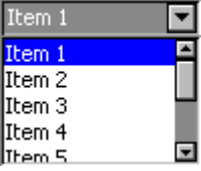
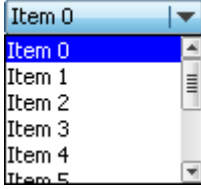

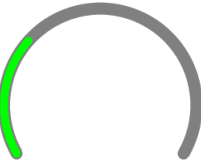
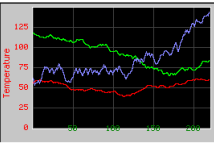

Since widgets are essentially windows it is possible to use most of the Window Manager API functions as well.

### 7.2.1 Some basics

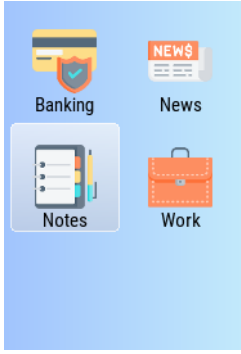



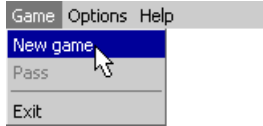
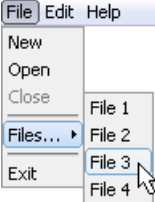

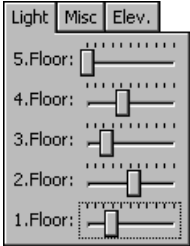
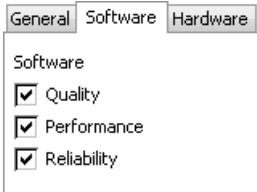



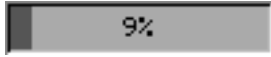

#### 7.2.1.1 Available widgets

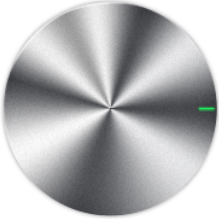
The following table shows the appearance of the currently available widgets. Some of the widgets support skinning. This method of changing the appearance is explained in detail in chapter *Skinning* on page 2800. The second screenshot shows the appearance when skinning is enabled for the widget:

Name	Screenshot (classic)	Screenshot (skinned)	Description
BUTTON			Button which can be pressed. Text or bitmaps may be displayed on a button.
CHECKBOX			Check box which may be checked or unchecked.
DROPDOWN			Dropdown listbox, opens a listbox when pressed.
EDIT			Single-line edit field which prompts the user to type a number or text.
FRAMEWIN			Frame window. Creates the typical GUI look.
GAUGE			Gauge widget, basically a radial progress bar.
GRAPH			Graph widget, used to show curves or measured values.
HEADER			Header control, used to manage columns.

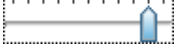
Name	Screenshot (classic)	Screenshot (skinned)	Description
ICONVIEW			<p>Icon view widget. Useful for icon based platforms as found in common hand held devices.</p>
IMAGE			<p>Image widget. Displays several image formats automatically.</p>
KEYBOARD			<p>Keyboard widget. Screen keyboard for (MULTI)EDIT input.</p>
LISTBOX			<p>Listbox which highlights items as they are selected by the user.</p>
LISTVIEW			<p>Listview widgets are used to creates tables.</p>
MENU			<p>Menu widgets are used to create horizontal and vertical menus.</p>
MOVIE			<p>Widget for displaying movie files with control elements.</p>
MULTIEDIT			<p>Multiedit widgets are used to edit multiple lines of text.</p>
MULTIPAGE			<p>Multipage widgets are used to create dialogs with multiple pages.</p>

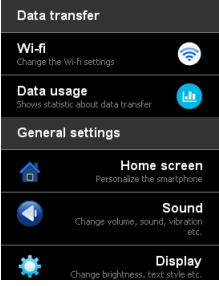
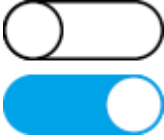

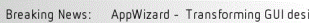

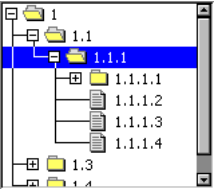
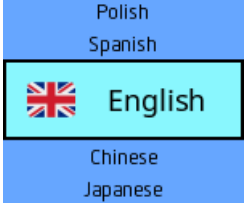
Name	Screenshot (classic)	Screenshot (skinned)	Description
PROGBAR			Progress bar used for visualization.
QRCODE			QR code.
RADIO		<input checked="" type="radio"/> Option 1 <input type="radio"/> Option 2 <input type="radio"/> Option 3	Radio button which may be selected. Only one button may be selected at a time.
ROTARY			Rotary dial widget which can be rotated to return uncountable values.
SCROLLBAR			PC-style scrollbar which may be horizontal or vertical.
SCROLLER			Smartphone-like scrollbar widget which may be horizontal or vertical.
SLIDER			Slider bar used for changing values.
SPINBOX			Spinning box to display and adjust a specific value.
SWIPELIST			Swipeable list widgets are used for creating swipeable lists which can be moved by swiping the finger (or any other PID) over the touch screen.
SWITCH			Switch which can be toggled.
TEXT			Static text labels typically used in dialogs.
TICKER			Scrolling text to display multiple strings one after each other.

Name	Screenshot (classic)	Screenshot (skinned)	Description
TREEVIEW			<p>Treeview widget for managing hierarchical lists.</p>
WHEEL			<p>Scrollable rotating wheel that displays lists of texts and/or bitmaps.</p>

## Obsolete widgets

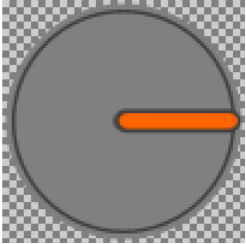
The following widgets are obsolete but are still included in emWin for compatibility reasons. The widgets have been replaced with newer versions, which are linked to at the beginning of the section of the widget.

Name	Screenshot (classic)	Screenshot (skinned)	Description
<b>KNOB</b> <b>Replaced by:</b> ROTARY			Knob widget which can be used to adjust uncountable values.
<b>LISTWHEEL</b> <b>Replaced by:</b> WHEEL			Listwheel widget. The data can be moved and accelerated via pointer input device.

### 7.2.1.2 Custom widget types

emWin users have the possibility to create custom types of widgets. This can be done using a custom callback function for an existing widget in order to preserve certain functionality. In case it is required to implement a new type of widget it is recommended to use a simple window as starting point and follow the instructions in AN03002\_Custom\_Widget\_Type.pdf which can also be found in the Doc-folder.

### 7.2.1.3 Understanding the redrawing mechanism

A widget draws itself according to its properties. This is done when `WM_Exec()`, `GUI_Exec()` or `GUI_Delay()` is called. In a multitasking environment, a background task is normally used to call `WM_Exec()` and update the widgets (and all other windows with callback functions).

When a property of a widget is changed, the window of the widget (or part of it) is marked as invalid, but it is not immediately redrawn. Therefore, the section of code executes very fast. The redrawing is done by the WM at a later time or it can be forced by calling `WM_Paint()` for the widget (or `WM_Exec()` until all windows are redrawn).

### 7.2.1.4 How to use widgets

Suppose we would like to display a progress bar. All that is needed is the following code:

```
PROGBAR_Handle hProgBar;
GUI_DispStringAt("Progress bar", 100, 20);
hProgBar = PROGBAR_Create(100, 40, 100, 20, WM_CF_SHOW);
```



The first line reserves memory for the handle of the widget. The last line actually creates the widget. The widget will then automatically be drawn by the Window Manager once `WM_Exec()` is called the next time, what may happen in a separate task.

Member functions are available for each type of widget which allow modifications to their appearance. Once the widget has been created, its properties can be changed by calling its member functions. These functions take the handle of the widget as their first argument. In order to make the progress bar created above show 45% and to change the bar colors

from their defaults (dark gray/light gray) to green/red, the following section of code may be used:

```
PROGBAR_SetBarColor(hProgBar, 0, GUI_GREEN);
PROGBAR_SetBarColor(hProgBar, 1, GUI_RED);
PROGBAR_SetValue(hProgBar, 45);
```



### Default configuration

All widgets also have one or more configuration macros which define various default settings such as fonts and colors used. The available configuration options are listed for each widget in their respective sections later in the chapter. The default configurations have to be set prior using the widget. Otherwise, the set properties will not be taken into account.

### How widgets communicate

Widgets are often created as child windows. The parent window may be any type of window, even another widget. A parent window usually needs to be informed whenever something occurs with one of its children in order to ensure synchronization. Child window widgets communicate with their parent window by sending a `WM_NOTIFY_PARENT` message whenever an event occurs. The notification code sent as part of the message depends on the event.

Most widgets have one or more notification codes defining different types of events. The available notification codes for each widget (if any) are listed under their respective sections.

### Skinning

The appearance of a widget can be modified by using the member functions of the respective widget. Some of the widgets support skinning. If skinning is used for a widget the 'skin' determines the appearance of the widget and some of the member functions have no effect. Details can be found in the chapter *Skinning* on page 2800.

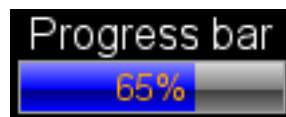

### Dynamic memory usage for widgets

In embedded applications it is usually not very desirable to use dynamic memory at all because of fragmentation effects. There are a number of different strategies that can be used to avoid this, but they all work in a limited way whenever memory areas are referenced by a pointer in the application program. For this reason, emWin uses a different approach: all objects (and all data stored at run-time) are stored in memory areas referenced by a handle. This makes it possible to relocate the allocated memory areas at run-time, thus avoiding the long-term allocation problems which occur when using pointers. All widgets are thus referenced by handles.

### Determine the type of a widget

The type of a widget can be determined by calling the routine `WIDGET_GetType()` on the given widget handle. The routine will return a unique ID that identifies the widget type.

## 7.2.2 Configuration options

Type	Macro	Default	Description
B	WIDGET_USE_PARENT_EFFECT	0	If set to 1, each 'child widget' of a widget, has the same effect as the parent widget. If for example a listbox needs to create a scroll bar, the new scroll bar has the same effect as the listbox.
B	WIDGET_USE_SCHEME_LARGE	0	If set to 1, the default appearance of the widgets is large sized. That means that all widgets which show text are configured to use large sized default fonts.
B	WIDGET_USE_SCHEME_MEDIUM	0	If set to 1, the default appearance of the widgets is medium sized. That means that all widgets which show text are configured to use medium sized default fonts.
B	WIDGET_USE_SCHEME_SMALL	1	If set to 1, the default appearance of the widgets is small sized. That means that all widgets which show text are configured to use small sized default fonts.
B	WIDGET_USE_FLEX_SKIN	0	If set to 1, widgets are drawn using the Flex Skin by default. Detailed information about skinning can be found in the chapter <i>Skinning</i> on page 2800.

### WIDGET\_USE\_SCHEME...

The table below shows the default appearance of the widget schemes:

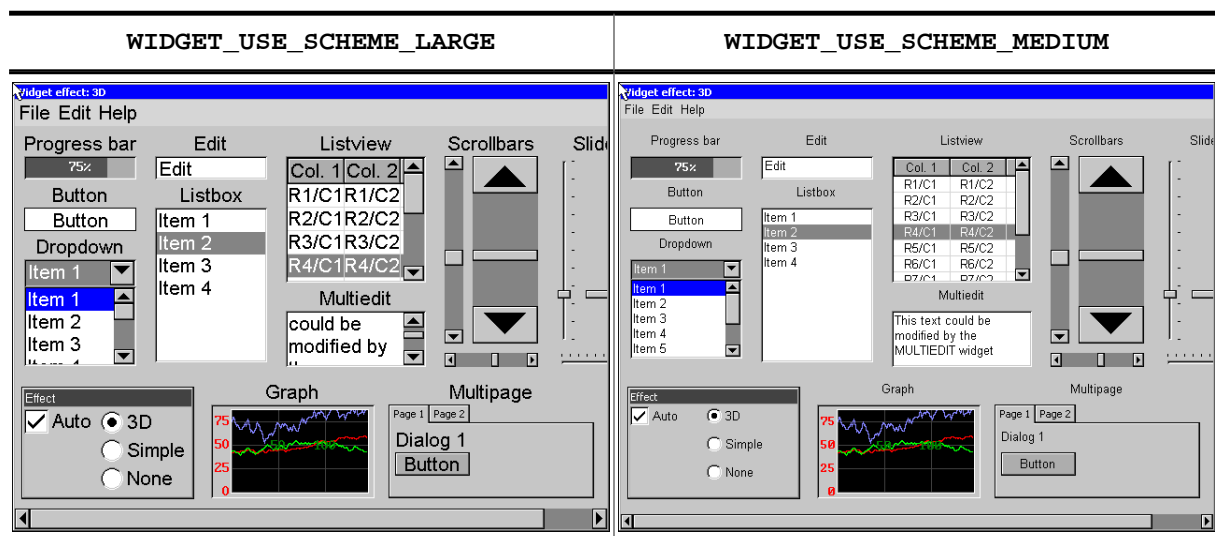

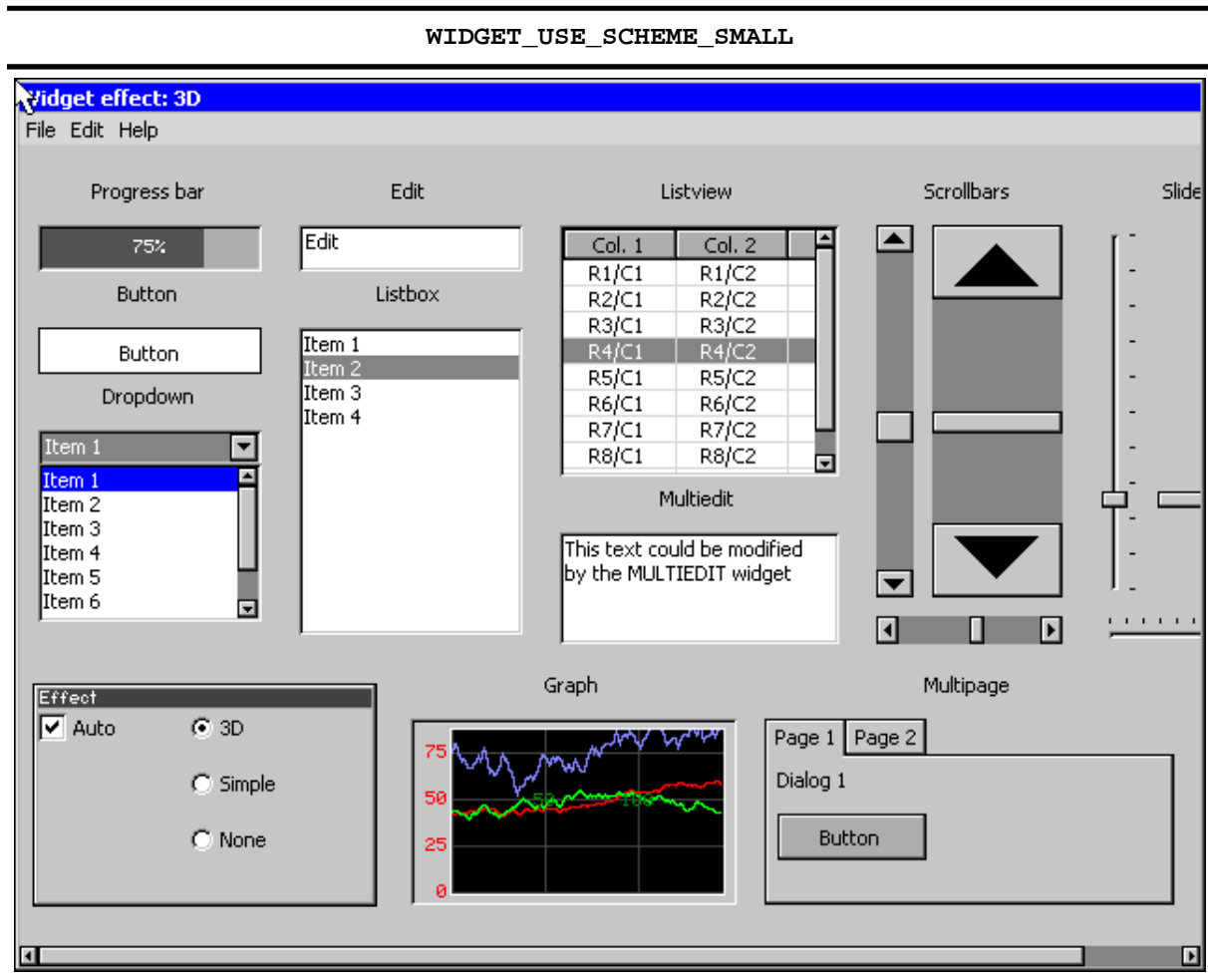

## 7.2.3 Widget IDs

In order to be able to separate all widgets from each other IDs can be assigned. This is usually done by using the according parameter of the `<WIDGET>_Create...()` functions. To make sure that every widget has its unique Id, predefined symbols may be used. The predefined symbols are listed in the subsections of the according widgets. If the predefined symbols do not match ones requirements, custom unique IDs may be defined as follows:

```
#define MY_WIDGET_ID_0 (GUI_ID_USER + 0)
#define MY_WIDGET_ID_1 (GUI_ID_USER + 1)
#define MY_WIDGET_ID_2 (GUI_ID_USER + 2)
#define MY_WIDGET_ID_3 (GUI_ID_USER + 3)
.
.
.
```

## 7.2.4 General widget API

### 7.2.4.1 WM routines used for widgets

Since widgets are essentially windows, they are compatible with any of the Window Manager API routines. The handle of the widget is used as the `hWin` parameter and the widget is treated like any other window. The WM functions most commonly used with widgets are listed as follows:

Routine	Description
<code>WM_DeleteWindow()</code>	Deletes a specified window.
<code>WM_DisableWindow()</code>	Disables the specified window.
<code>WM_EnableMemdev()</code>	Enables the use of Memory Devices for redrawing a window.
<code>WM_InvalidateWindow()</code>	Invalidates a specified window.
<code>WM_Paint()</code>	Draws or redraws a specified window immediately.

The complete list of WM-related functions can be found in the chapter *The Window Manager (WM)* on page 960.

### 7.2.4.2 Common routines

The table below lists available widget-related routines in alphabetical order. These functions are common to all widgets, and are listed here in order to avoid repetition. Detailed descriptions of the routines follow. The additional member functions available for each widget may be found in later sections.

Routine	Description
<code>&lt;WIDGET&gt;_Callback()</code>	Default callback function.
<code>&lt;WIDGET&gt;_CreateIndirect()</code>	Used for automatic creation in dialog boxes.
<code>&lt;WIDGET&gt;_CreateUser()</code>	Creates a widget using extra bytes as user data.
<code>WIDGET_GetMinTimePerFrame()</code>	Returns the minimum time per frame used for animations that are created by widgets.
<code>WIDGET_GetType()</code>	Returns the type ID of a given widget.
<code>&lt;WIDGET&gt;_GetUserData()</code>	Retrieves the data set with <code>&lt;WIDGET&gt;_SetUserData</code> .
<code>&lt;WIDGET&gt;_SetUserData()</code>	Sets the extra data of a widget.
<code>WIDGET_EnableStreamAuto()</code>	Enables support for all streamed bitmap formats.
<code>WIDGET_GetDefaultEffect()</code>	Returns the default effect used for widgets.
<code>WIDGET_SetDefaultEffect()</code>	Sets the default effect used for widgets.
<code>WIDGET_SetEffect()</code>	Sets the effect for the given widget.
<code>WIDGET_SetFocusable()</code>	Sets the ability to receive the input focus.
<code>WIDGET_SetMinTimePerFrame()</code>	Sets the minimum time per frame used for animations that are created by widgets.

### 7.2.4.2.1 <WIDGET>\_Callback()

#### Description

Default callback function of the widgets to be used from within overwritten callback function.

#### Prototype

```
void <WIDGET>_Callback(WM_MESSAGE * pMsg);
```

Parameter	Description
<a href="#">pMsg</a>	Pointer to a data structure of type WM_MESSAGE.

#### Additional information

A default callback function of a widget should not be called directly. It is only to be used from within an overwritten callback function.

This function replaces the default callback of a standard window when overwriting a WIDGET callback function (`WM_DefaultProc()`).

For details about the WM\_MESSAGE data structure, refer to *Messages* on page 975.



### 7.2.4.2.2 <WIDGET>\_CreateIndirect()

#### Description

Creates a widget to be used in dialog boxes.

#### Prototype

```
<WIDGET>_Handle <WIDGET>_CreateIndirect(const GUI_WIDGET_CREATE_INFO * pCreateInfo,
                                         WM_HWIN                    hParent,
                                         int                        x0,
                                         int                        y0,
                                         WM_CALLBACK              * cb);
```

Parameter	Description
<code>pCreateInfo</code>	Pointer to a <code>GUI_WIDGET_CREATE_INFO</code> structure (see below).
<code>hParent</code>	Handle of parent window.
<code>x0</code>	Leftmost pixel of the widget (in parent coordinates).
<code>y0</code>	Topmost pixel of the widget (in parent coordinates).
<code>cb</code>	Pointer to a callback function. <b>Not used, reserved for future usage.</b> To set a custom callback to the widget, <code>WM_SetCallback()</code> has to be used after the widget has been created.

#### Additional information

Any widget may be created indirectly by using the appropriate prefix. For example: `BUTTON_CreateIndirect()` to indirectly create a button widget, `CHECKBOX_CreateIndirect()` to indirectly create a check box widget, and so on.

A widget only needs to be created indirectly if it is to be included in a dialog box. Otherwise, it may be created directly by using the `<WIDGET>_Create()` functions. See the chapter *Dialogs* on page 2742 for more information about dialog boxes.

#### Resource table

The `GUI_WIDGET_CREATE_INFO` data structure is defined in the dialog resource table as follows:

```
typedef struct {
    GUI_WIDGET_CREATE_FUNC * pfCreateIndirect;    // Create function
    const char * pName;                          // Text
    (not used for all widgets)
    I16 Id;                                       // Window ID of the widget
    I16
    x0, y0, xSize, ySize; // Size and position of the widget
    I16 Flags;                                    // Widget-specific flags (or 0)
    I32 Para;                                    // Widget-specific parameter (or
0)
    U32 NumExtraBytes;                          // Number of extra bytes usable
// with <WIDGET>_SetUserData &
// <WIDGET>_GetUserData
} GUI_WIDGET_CREATE_INFO;
```

Widget flags and parameters are optional, and vary depending on the type of widget. The available flags and parameters for each widget (if any) will be listed under the appropriate section later in this chapter.

### 7.2.4.2.3 <WIDGET>\_CreateUser()

#### Description

Creates a widget using extra bytes as user data. This function is similar to the <WIDGET>\_CreateEx() function of the appropriate widget in every case except the additional parameter [NumExtraBytes](#).

#### Prototype

```
<WIDGET>_Handle <WIDGET>_CreateUser(int x0,
                                   int y0,
                                   ... ...,
                                   int Id,
                                   int NumExtraBytes);
```

Parameter	Description
<a href="#">NumBytes</a>	Number of extra bytes to be allocated

#### Return value

Handle of the created widget.  
0 if the function fails.

#### Additional information

For more information about the other parameters the appropriate <WIDGET>\_CreateEx() functions can be referred to.

#### 7.2.4.2.4 WIDGET\_GetMinTimePerFrame()

##### Description

Returns the minimum time per frame used for animations that are created by widgets.

##### Prototype

```
U16 WIDGET_GetMinTimePerFrame(void);
```

##### Return value

Minimum time per frame used for animations.

### 7.2.4.2.5 WIDGET\_GetType()

#### Description

Returns the type ID of a given widget.

#### Prototype

```
U32 WIDGET_GetType(WM_HWIN hObj);
```

#### Parameters

Parameter	Description
<a href="#">hObj</a>	Handle of widget.

#### Return value

- = 0      Undefined widget type.
- ≠ 0     Unique widget type ID, see *Widget type IDs* on page 1173.

### 7.2.4.2.6 <WIDGET>\_GetUserData()

#### Description

Retrieves the data set with <WIDGET>\_SetUserData.

#### Prototype

```
int <WIDGET>_GetUserData(<WIDGET>_Handle hObj,  
                        void * pDest,  
                        int NumBytes);
```

Parameter	Description
<a href="#">hObj</a>	Handle of the widget
<a href="#">pDest</a>	Pointer to buffer
<a href="#">NumBytes</a>	Number of bytes to read

#### Return value

Number of bytes read.

#### Additional information

The maximum number of bytes returned by this function is the number of extra bytes specified when creating the widget using <WIDGET>\_CreateUser() or <WIDGET>\_CreateIndirect().

### 7.2.4.2.7 <WIDGET>\_SetUserData()

#### Description

Sets the extra data of a widget.

#### Prototype

```
int <WIDGET>_SetUserData(<WIDGET>_Handle hObj,
                        void * pDest,
                        int NumBytes);
```

Parameter	Description
<code>hObj</code>	Handle of the widget
<code>pDest</code>	Pointer to buffer
<code>NumBytes</code>	Number of bytes to write

#### Return value

Number of bytes written.

#### Additional information

The maximum number of bytes used to store user data is the number of extra bytes specified when creating the widget using `<WIDGET>_CreateUser()` or `<WIDGET>_CreateIndirect()`.

### 7.2.4.2.8 WIDGET\_EnableStreamAuto()

#### Description

Enables drawing of all supported streamed bitmap formats for widgets like ICONVIEW and IMAGE widget.

#### Prototype

```
void WIDGET_EnableStreamAuto(void);
```

#### Additional information

Per default support for drawing all streamed bitmap formats is enabled. To be able to spare ROM that support could be disabled by adding the following line to `GUIConf.h`:

```
#define GUI_USE_STREAMED_BITMAP_AUTO 0
```

### 7.2.4.2.9 WIDGET\_GetDefaultEffect()

#### Description

Returns the default effect used for widgets.

#### Prototype

```
const WIDGET_EFFECT * WIDGET_GetDefaultEffect(void);
```

#### Return value

The result of the function is a pointer to a `WIDGET_EFFECT` structure.

#### Additional information

For more information, refer to *WIDGET\_SetDefaultEffect* on page 1169.



### 7.2.4.2.10 WIDGET\_SetDefaultEffect()

#### Description

Sets the default effect used for widgets.

#### Prototype

```
const WIDGET_EFFECT * WIDGET_SetDefaultEffect(const WIDGET_EFFECT * pEffect);
```

#### Parameters

Parameter	Description
<code>pEffect</code>	Pointer to a <code>WIDGET_EFFECT</code> structure. See table below.

#### Permitted values for parameter `pEffect`





<code>&amp;WIDGET_Effect_3D</code>	Sets the default effect to <i>3D</i> .
<code>&amp;WIDGET_Effect_None</code>	Sets the default effect to <i>None</i> .
<code>&amp;WIDGET_Effect_Simple</code>	Sets the default effect to <i>Simple</i> .

#### Return value

Previous used default effect.

#### Additional information

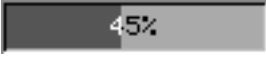
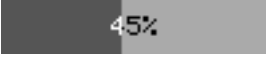
The following table shows the appearance of some widgets in dependence of the used effect:

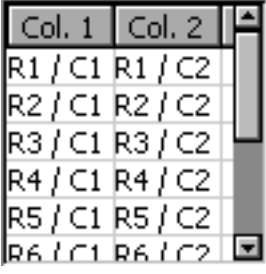
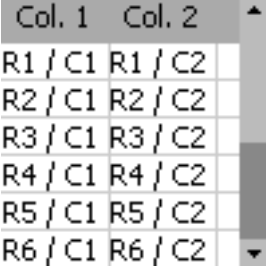
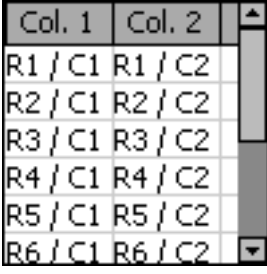
3D	None	Simple
		
		
		

### 7.2.4.2.11 WIDGET\_SetEffect()

#### Description

Sets the effect for the given widget.

#### Prototype

```
void WIDGET_SetEffect(      WM_HWIN      hObj,  
                        const WIDGET_EFFECT * pEffect);
```

#### Parameters

Parameter	Description
<code>hObj</code>	Handle of widget.
<code>pEffect</code>	Pointer to a <code>WIDGET_EFFECT</code> structure. For details, refer to <code>WIDGET_SetDefaultEffect</code> on page 1169.

### 7.2.4.2.12 WIDGET\_SetFocusable()

#### Description

Sets the ability to receive the input focus.

#### Prototype

```
void WIDGET_SetFocusable(WM_HWIN hObj,  
                        int State);
```

#### Parameters

Parameter	Description
<code>hObj</code>	Handle of widget.
<code>State</code>	(see table below)

Permitted values for parameter <code>State</code>	
1	Widget can receive the input focus.
0	Widget can't receive the input focus.

### 7.2.4.2.13 WIDGET\_SetMinTimePerFrame()

#### Description

Sets the minimum time per frame used for animations that are created by widgets.

#### Prototype

```
U16 WIDGET_SetMinTimePerFrame(U16 MinTimePerFrame);
```

#### Parameters

Parameter	Description
<a href="#">MinTimePerFrame</a>	Period to be used.

#### Return value

Previous value.

### 7.2.4.3 Widget type IDs

#### Description

Unique type IDs for all widget types.

#### Definition

```
#define WIDGET_TYPE_BUTTON          /* BUTT */ 0x42555454UL
#define WIDGET_TYPE_CHECKBOX       /* CHEC */ 0x43484543UL
#define WIDGET_TYPE_DROPDOWN       /* DROP */ 0x44524F50UL
#define WIDGET_TYPE_EDIT           /* EDIT */ 0x45444954UL
#define WIDGET_TYPE_FRAMEWIN       /* FRAM */ 0x4652414DUL
#define WIDGET_TYPE_FRAMEWIN_CLIENT /* FRAC */ 0x46524143UL
#define WIDGET_TYPE_GRAPH          /* GRAP */ 0x47524150UL
#define WIDGET_TYPE_HEADER         /* HEAD */ 0x48454144UL
#define WIDGET_TYPE_KEYBOARD       /* KEYB */ 0x4B455942UL
#define WIDGET_TYPE_LISTBOX        /* LISB */ 0x4C495342UL
#define WIDGET_TYPE_LISTVIEW       /* LISV */ 0x4C495356UL
#define WIDGET_TYPE_LISTWHEEL      /* LISW */ 0x4C495357UL
#define WIDGET_TYPE_MENU           /* MENU */ 0x4D454E55UL
#define WIDGET_TYPE_MOVIE          /* MOVI */ 0x4D4F5649UL
#define WIDGET_TYPE_MULTIEDIT      /* MULE */ 0x4D554C45UL
#define WIDGET_TYPE_MULTIPAGE      /* MULP */ 0x4D554C50UL
#define WIDGET_TYPE_MULTIPAGE_CLIENT /* MPCL */ 0x4D50434CUL
#define WIDGET_TYPE_PROGBAR        /* PROG */ 0x50524F47UL
#define WIDGET_TYPE_RADIO          /* RADI */ 0x52414449UL
#define WIDGET_TYPE_SCROLLBAR      /* SCRO */ 0x5343524FUL
#define WIDGET_TYPE_SLIDER         /* SLID */ 0x534C4944UL
#define WIDGET_TYPE_SWIPELIST      /* SWIP */ 0x53574950UL
#define WIDGET_TYPE_TEXT           /* TEXT */ 0x54455854UL
#define WIDGET_TYPE_TREEVIEW       /* TREE */ 0x54524545UL
#define WIDGET_TYPE_ICONVIEW       /* ICON */ 0x49434F4EUL
#define WIDGET_TYPE_IMAGE          /* IMAG */ 0x494D4147UL
#define WIDGET_TYPE_SPINBOX        /* SPIN */ 0x5350494EUL
#define WIDGET_TYPE_KNOB           /* KNOB */ 0x4B4E4F42UL
#define WIDGET_TYPE_WINDOW         /* WIND */ 0x57494E44UL
#define WIDGET_TYPE_ROTARY         /* ROTA */ 0x524F5441UL
#define WIDGET_TYPE_SWITCH         /* SWIT */ 0x53574954UL
#define WIDGET_TYPE_TICKER         /* TICK */ 0x5449434BUL
#define WIDGET_TYPE_GAUGE          /* GAUG */ 0x47415547UL
#define WIDGET_TYPE_QR_CODE        /* QRCO */ 0x5152434FUL
#define WIDGET_TYPE_SCROLLER       /* SCRL */ 0x5343523CUL
#define WIDGET_TYPE_WHEEL          /* WHEL */ 0x5748454CUL
```

#### Symbols

Definition	Description
<a href="#">WIDGET_TYPE_BUTTON</a>	BUTTON widget.
<a href="#">WIDGET_TYPE_CHECKBOX</a>	CHECKBOX widget.
<a href="#">WIDGET_TYPE_DROPDOWN</a>	DROPDOWN widget.
<a href="#">WIDGET_TYPE_EDIT</a>	EDIT widget.
<a href="#">WIDGET_TYPE_FRAMEWIN</a>	FRAMEWIN widget.
<a href="#">WIDGET_TYPE_FRAMEWIN_CLIENT</a>	FRAMEWIN client widget.
<a href="#">WIDGET_TYPE_GRAPH</a>	GRAPH widget.
<a href="#">WIDGET_TYPE_HEADER</a>	HEADER widget.
<a href="#">WIDGET_TYPE_KEYBOARD</a>	KEYBOARD widget.
<a href="#">WIDGET_TYPE_LISTBOX</a>	LISTBOX widget.
<a href="#">WIDGET_TYPE_LISTVIEW</a>	LISTVIEW widget.

Definition	Description
WIDGET_TYPE_LISTWHEEL	LISTWHEEL widget.
WIDGET_TYPE_MENU	MENU widget.
WIDGET_TYPE_MOVIE	MOVIE widget.
WIDGET_TYPE_MULTIEDIT	MULTIEDIT widget.
WIDGET_TYPE_MULTIPAGE	MULTIPAGE widget.
WIDGET_TYPE_MULTI-PAGE_CLIENT	MULTIPAGE client widget.
WIDGET_TYPE_PROGBAR	PROGBAR widget.
WIDGET_TYPE_RADIO	RADIO widget.
WIDGET_TYPE_SCROLLBAR	SCROLLBAR widget.
WIDGET_TYPE_SLIDER	SLIDER widget.
WIDGET_TYPE_SWIPELIST	SWIPELIST widget.
WIDGET_TYPE_TEXT	TEXT widget.
WIDGET_TYPE_TREEVIEW	TREEVIEW widget.
WIDGET_TYPE_ICONVIEW	ICONVIEW widget.
WIDGET_TYPE_IMAGE	IMAGE widget.
WIDGET_TYPE_SPINBOX	SPINBOX widget.
WIDGET_TYPE_KNOB	KNOB widget.
WIDGET_TYPE_WINDOW	WINDOW widget.
WIDGET_TYPE_ROTARY	ROTARY widget.
WIDGET_TYPE_SWITCH	SWITCH widget.
WIDGET_TYPE_TICKER	TICKER widget.
WIDGET_TYPE_GAUGE	GAUGE widget.
WIDGET_TYPE_QRCODE	QRCODE widget.
WIDGET_TYPE_SCROLLER	SCROLLER widget.
WIDGET_TYPE_WHEEL	WHEEL widget.

### 7.2.4.4 User drawn widgets

Some widgets supports owner drawing, for example the LISTBOX widget. If the user draw mode of a widget has been activated a application-defined function of type `WIDGET_DRAW_ITEM_FUNC` will be called to draw the widget (item). The prototype of an application-defined owner draw function should be defined as follows:

#### Prototype

```
int WIDGET_DRAW_ITEM_FUNC(const WIDGET_ITEM_DRAW_INFO * pDrawItemInfo);
```

Parameter	Description
<code>pDrawItemInfo</code>	Pointer to a <code>WIDGET_ITEM_DRAW_INFO</code> structure.

#### Elements of structure `WIDGET_ITEM_DRAW_INFO`

Data type	Element	Description
<code>WM_HWIN</code>	<code>hWin</code>	Handle to the widget.
<code>int</code>	<code>Cmd</code>	See table below.
<code>int</code>	<code>ItemIndex</code>	Zero based index of item to be drawn.
<code>int</code>	<code>Col</code>	Zero based column index of item to be drawn.
<code>int</code>	<code>x0</code>	<code>x0</code> window coordinate which is used to draw the item.
<code>int</code>	<code>y0</code>	<code>y0</code> window coordinate which is used to draw the item.
<code>int</code>	<code>x1</code>	<code>x1</code> window coordinate which is used to draw the item.
<code>int</code>	<code>y1</code>	<code>y1</code> window coordinate which is used to draw the item.

Permitted values for parameter <code>Cmd</code>	
<code>WIDGET_ITEM_GET_XSIZE</code>	The function returns the x-size (width) in pixels of the given item.
<code>WIDGET_ITEM_GET_YSIZE</code>	The function returns the y-size (height) in pixels of the given item.
<code>WIDGET_ITEM_DRAW</code>	The function draws the given item at the given position.
<code>WIDGET_DRAW_BACKGROUND</code>	The background of the widget should be drawn.
<code>WIDGET_DRAW_OVERLAY</code>	This command is sent after all other drawing operations have been finished and enables the possibility to draw some overlaying items above the widget.

#### Return value

Depends on the given command.

#### Reaction to commands

The function has to react to the command given in the `WIDGET_ITEM_DRAW_INFO` structure. This can be done in one of 2 ways:

- By calling the appropriate default function supplied by the particular widget (for example, `LISTBOX_OwnerDraw()`)
- By supplying code that reacts accordingly.

## Commands

The commands listed below are supported and should be reacted to by the function. As explained above, the default owner draw function should be called for all not handled functions. This can save code size (for example if the height is the same as the default height) and makes sure that your code stays compatible if additional commands are introduced in future versions of the software.

### **WIDGET\_ITEM\_GET\_XSIZE**

The X-size in pixels of the given item has to be returned.

### **WIDGET\_ITEM\_GET\_YSIZE**

The Y-size (height) in pixels of the given item has to be returned.

### **WIDGET\_ITEM\_DRAW**

The given item has to be drawn. `x0` and `y0` of the `WIDGET_ITEM_DRAW_INFO` structure specify the position of the item in window coordinates. The item has to fill its entire rectangle; the rectangle is defined by the starting position `x0`, `y0` supplied to the function and the sizes returned by the function as reaction to the commands `WIDGET_ITEM_GET_YSIZE`, `WIDGET_ITEM_GET_XSIZE`. It may NOT leave a part of this rectangular area unpainted. It can not paint outside of this rectangular area because the clip rectangle has been set before the function call.



## 7.2.5 BUTTON: Button widget

BUTTON widgets are commonly used as the primary user interface element for touch-screens. If the button has the input focus, it also reacts on the keys `GUI_KEY_SPACE` and `GUI_KEY_ENTER`. Buttons may be displayed with text, as shown below, or with a bitmap.



### Note

All BUTTON-related routines are located in the file(s) `BUTTON*.c`, `BUTTON.h`. All identifiers are prefixed `BUTTON`.

### Skining...



...is available for this widget. The screenshot above shows the widget using the default skin. Details can be found in the chapter *Skining* on page 2800.

### Note

This widget uses skinning in combination with the flex skin. To change the style of the skin use the function `<WIDGET>_SetSkinFlexProps()`.

Other functions to change the look might work only with the classic skin.

### 7.2.5.1 Configuration options

Type	Macro	Default	Description
N	<code>BUTTON_3D_MOVE_X</code>	1	Number of pixels that text/ bitmap moves in horizontal direction in pressed state.
N	<code>BUTTON_3D_MOVE_Y</code>	1	Number of pixels that text/ bitmap moves in vertical direction in pressed state.
N	<code>BUTTON_ALIGN_DEFAULT</code>	<code>GUI_TA_HCENTER</code>   <code>GUI_TA_VCENTER</code>	Alignment used to display the button text.
N	<code>BUTTON_BKCOLOR0_DEFAULT</code>	0xAAAAAA	Background color, unpressed state.
N	<code>BUTTON_BKCOLOR1_DEFAULT</code>	<code>GUI_WHITE</code>	Background color, pressed state.
N	<code>BUTTON_FOCUSCOLOR_DEFAULT</code>	<code>GUI_BLACK</code>	Default color for rendering the focus rectangle.
S	<code>BUTTON_FONT_DEFAULT</code>	<code>&amp;GUI_Font13_1</code>	Font used for button text.
B	<code>BUTTON_REACT_ON_LEVEL</code>	0	See description below.
N	<code>BUTTON_TEXTCOLOR0_DEFAULT</code>	<code>GUI_BLACK</code>	Text color, unpressed state.
N	<code>BUTTON_TEXTCOLOR1_DEFAULT</code>	<code>GUI_BLACK</code>	Text color, pressed state.

#### 7.2.5.1.1 BUTTON\_REACT\_ON\_LEVEL

There are 2 ways for a BUTTON widget to handle PID events.

The default way of handling PID events for the BUTTON widget is reacting on level changes only. This means BUTTON widgets react only if the PID state changes on the BUTTON. This can be enabled by calling the function `BUTTON_SetReactOnLevel()`.

The obsolete (and former default) way is recognizing and processing all PID events which happen in the BUTTON area. This includes PIDs moved in the BUTTON area in pressed state. The BUTTON widget would “accept” the pressed state and change its state accordingly. The disadvantage of this mode is that BUTTONs may be clicked by mistake. This logic can be enabled either by defining `BUTTON_REACT_ON_LEVEL` with 0 or by calling the function `BUTTON_SetReactOnTouch()`.

### Example for an unwanted BUTTON click

This example shows how a BUTTON widget may be mistakenly clicked without the BUTTON being configured to react on level. In the example the mouse is clicked once. The click closes the expanded DROPDOWN and subsequently clicks the BUTTON behind.

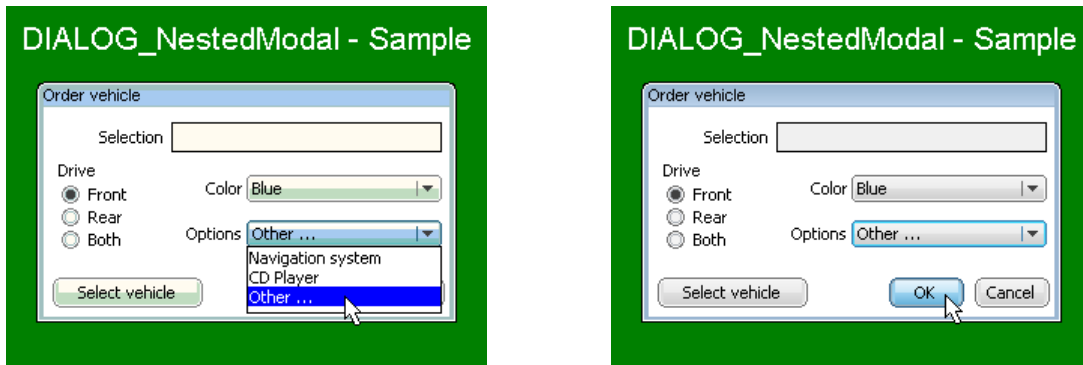

#### 7.2.5.1.2 BUTTON\_BKCOLOR0\_DEFAULT, BUTTON\_BKCOLOR1\_DEFAULT

The default for the BUTTON widget is to use a white background in the pressed state. This has been done purposely because it makes it very obvious that the button is pressed, on any kind of display. If you want the background color of the BUTTON widget to be the same in both its pressed and unpressed states, change `BUTTON_BKCOLOR1_DEFAULT` to `BUTTON_BKCOLOR0_DEFAULT`.

#### 7.2.5.2 Predefined IDs

The following symbols define IDs which may be used to make BUTTON widgets distinguishable from creation.

```
#define GUI_ID_BUTTON0    0x170
#define GUI_ID_BUTTON1    0x171
#define GUI_ID_BUTTON2    0x172
#define GUI_ID_BUTTON3    0x173
#define GUI_ID_BUTTON4    0x174
#define GUI_ID_BUTTON5    0x175
#define GUI_ID_BUTTON6    0x176
#define GUI_ID_BUTTON7    0x177
#define GUI_ID_BUTTON8    0x178
#define GUI_ID_BUTTON9    0x179
```

#### 7.2.5.3 Notification codes

The following events are sent from a BUTTON widget to its parent window as part of a `WM_NOTIFY_PARENT` message:

Message	Description
<code>WM_NOTIFICATION_CLICKED</code>	BUTTON has been clicked.
<code>WM_NOTIFICATION_RELEASED</code>	BUTTON has been released.
<code>WM_NOTIFICATION_MOVED_OUT</code>	BUTTON has been clicked and pointer has been moved out of the BUTTON widget without releasing.

### 7.2.5.4 Keyboard reaction

The BUTTON widget reacts to the following keys if it has the input focus:

Key	Reaction
GUI_KEY_ENTER	If the key is pressed, the BUTTON reacts as it has been pressed and immediately released.
GUI_KEY_SPACE	If the key is pressed, the BUTTON state changes to pressed. If the key is released, the BUTTON state changes to unpressed.

### 7.2.5.5 BUTTON API

The table below lists the available emWin BUTTON-related routines in alphabetical order. Detailed descriptions of the routines follow.

#### Functions

Routine	Description
<code>BUTTON_Create()</code>	Creates a BUTTON widget. (Obsolete)
<code>BUTTON_CreateAsChild()</code>	Creates a BUTTON widget as a child window. (Obsolete)
<code>BUTTON_CreateEx()</code>	Creates a BUTTON widget.
<code>BUTTON_CreateIndirect()</code>	Creates a BUTTON widget from a resource table entry.
<code>BUTTON_CreateUser()</code>	Creates a BUTTON widget using extra bytes as user data.
<code>BUTTON_GetBitmap()</code>	Returns a pointer to the optional BUTTON bitmap.
<code>BUTTON_GetBkColor()</code>	Returns the background color of the given BUTTON widget.
<code>BUTTON_GetDefaultBkColor()</code>	Returns the default background color for BUTTON widgets.
<code>BUTTON_GetDefaultFont()</code>	Returns the pointer to the font used to display the text of BUTTON widgets.
<code>BUTTON_GetDefaultTextAlign()</code>	Returns the default text alignment used to display the text of BUTTON widgets.
<code>BUTTON_GetDefaultTextColor()</code>	Returns the default text color used to display the text of BUTTON widgets.
<code>BUTTON_GetFont()</code>	Returns a pointer to the font used to display the text of the given BUTTON widget.
<code>BUTTON_GetText()</code>	Retrieves the text of the specified BUTTON widget.
<code>BUTTON_GetTextAlign()</code>	Returns the alignment of the BUTTON text.
<code>BUTTON_GetTextColor()</code>	Returns the text color of the given BUTTON widget.
<code>BUTTON_GetUserData()</code>	Retrieves the data set with <code>BUTTON_SetUserData()</code> .
<code>BUTTON_IsPressed()</code>	Returns if the BUTTON is pressed or not.
<code>BUTTON_SetBitmap()</code>	Sets the bitmap used when displaying the BUTTON.
<code>BUTTON_SetBitmapEx()</code>	Sets the bitmap used when displaying the BUTTON.

Routine	Description
<code>BUTTON_SetBkColor()</code>	Sets the background color of a BUTTON widget.
<code>BUTTON_SetBMP()</code>	Sets the bitmap to be displayed on the specified BUTTON widget.
<code>BUTTON_SetBMPEX()</code>	Sets the bitmap to be displayed at the specified position on the given BUTTON widget.
<code>BUTTON_SetDefaultBkColor()</code>	Sets the default background color used for BUTTON widgets.
<code>BUTTON_SetDefaultFocusColor()</code>	Sets the default focus rectangle color for BUTTON widgets. (Obsolete)
<code>BUTTON_SetDefaultFont()</code>	Sets a pointer to a <code>GUI_FONT</code> structure used to display the text of BUTTON widgets.
<code>BUTTON_SetDefaultTextAlign()</code>	Sets the default text alignment used to display the text of BUTTON widgets.
<code>BUTTON_SetDefaultTextColor()</code>	Sets the default text color used to display the text of BUTTON widgets.
<code>BUTTON_SetFocusColor()</code>	Sets the color used to render the focus rectangle of the BUTTON widget. (Obsolete)
<code>BUTTON_SetFocusable()</code>	Sets the ability to receive the input focus.
<code>BUTTON_SetFont()</code>	Sets the font of the BUTTON widget.
<code>BUTTON_SetFrameColor()</code>	Sets the color of BUTTON frame. (Obsolete)
<code>BUTTON_SetPressed()</code>	Sets the state of the button to pressed or unpressed.
<code>BUTTON_SetReactOnLevel()</code>	Sets all BUTTON widgets to react on level changes of the PID.
<code>BUTTON_SetReactOnTouch()</code>	Sets all BUTTON widgets to react on touch events.
<code>BUTTON_SetStreamedBitmap()</code>	Sets the streamed bitmap used when displaying the BUTTON widget.
<code>BUTTON_SetStreamedBitmapEx()</code>	Sets the streamed bitmap used when displaying the BUTTON widget.
<code>BUTTON_SetText()</code>	Sets the text.
<code>BUTTON_SetTextAlign()</code>	Sets the text alignment of the BUTTON widget.
<code>BUTTON_SetTextColor()</code>	Set the color(s) for the text.
<code>BUTTON_SetTextOffset()</code>	Adjusts the position of the BUTTON text considering the current text alignment setting.
<code>BUTTON_SetToggleMode()</code>	Enables toggle mode for the BUTTON widget.
<code>BUTTON_SetUserData()</code>	Sets the extra data of a BUTTON widget.
<code>BUTTON_Toggle()</code>	Toggles the state of the given BUTTON.

## Defines

Group of defines	Description
<code>BUTTON</code> bitmap indexes	Bitmap indexes for BUTTON widget.
<code>BUTTON</code> color indexes	Color indexes for BUTTON widget.

## 7.2.5.5.1 Functions

### 7.2.5.5.1.1 BUTTON\_Create()

#### Note

This function is **deprecated**, `BUTTON_CreateEx()` should be used instead.

#### Description

Creates a BUTTON widget of a specified size at a specified location.

#### Prototype

```
BUTTON_Handle BUTTON_Create(int x0,
                           int y0,
                           int xSize,
                           int ySize,
                           int Id,
                           int Flags);
```

#### Parameters

Parameter	Description
<code>x0</code>	Leftmost pixel of the button (in parent coordinates).
<code>y0</code>	Topmost pixel of the button (in parent coordinates).
<code>xSize</code>	Horizontal size of the button (in pixels).
<code>ySize</code>	Vertical size of the button (in pixels).
<code>Id</code>	ID to be returned when button is pressed.
<code>Flags</code>	Window create flags. Typically <code>WM_CF_SHOW</code> in order to make the widget visible immediately (refer to <i>Window create flags</i> on page 1146 for a list of available parameter values).

#### Return value

Handle of the created BUTTON widget; 0 if the function fails.

### 7.2.5.5.1.2 BUTTON\_CreateAsChild()

#### Note

This function is **deprecated**, `BUTTON_CreateEx()` should be used instead.

#### Description

Creates a `BUTTON` widget as a child window.

#### Prototype

```
BUTTON_Handle BUTTON_CreateAsChild(int    x0,
                                   int    y0,
                                   int    xSize,
                                   int    ySize,
                                   WM_HWIN hParent,
                                   int    Id,
                                   int    Flags);
```

#### Parameters

Parameter	Description
<code>x0</code>	Leftmost pixel of the button (in parent coordinates).
<code>y0</code>	Topmost pixel of the button (in parent coordinates).
<code>xSize</code>	Horizontal size of the button (in pixels).
<code>ySize</code>	Vertical size of the button (in pixels).
<code>hParent</code>	Handle of parent window. If 0, the <code>BUTTON</code> widget will be a child of the desktop (top-level window).
<code>Id</code>	ID to be returned when button is pressed.
<code>Flags</code>	Window create flags (see <i>Window create flags</i> on page 1146).

#### Return value

Handle of the created `BUTTON` widget; 0 if the function fails.

### 7.2.5.5.1.3 BUTTON\_CreateEx()

#### Description

Creates a `BUTTON` widget of a specified size at a specified location.

#### Prototype

```
BUTTON_Handle BUTTON_CreateEx(int    x0,
                               int    y0,
                               int    xSize,
                               int    ySize,
                               WM_HWIN hParent,
                               int    WinFlags,
                               int    ExFlags,
                               int    Id);
```

#### Parameters

Parameter	Description
<code>x0</code>	Leftmost pixel of the button (in parent coordinates).
<code>y0</code>	Topmost pixel of the button (in parent coordinates).
<code>xSize</code>	Horizontal size of the button (in pixels).
<code>ySize</code>	Vertical size of the button (in pixels).
<code>hParent</code>	Handle of parent window. If 0, the <code>BUTTON</code> widget will be a child of the desktop (top-level window).
<code>WinFlags</code>	Window create flags. Typically <code>WM_CF_SHOW</code> in order to make the widget visible immediately (refer to <i>Window create flags</i> on page 1146 for a list of available parameter values).
<code>ExFlags</code>	Not used yet, reserved for future use.
<code>Id</code>	Window ID of the widget.

#### Return value

Handle of the created `BUTTON` widget; 0 if the function fails.

#### Additional information

If the possibility of storing user data is a matter the function `BUTTON_CreateUser()` should be used instead.

#### 7.2.5.5.1.4 **BUTTON\_CreateIndirect()**

##### **Description**

The prototype of this function is explained at the beginning of this chapter. Details can be found in the description of the function `<WIDGET>_CreateIndirect()` on page 1161. The elements `Flags` and `Para` of the according `GUI_WIDGET_CREATE_INFO` structure are not used.



### 7.2.5.5.1.5 BUTTON\_CreateUser()

#### Description

Prototype explained at the beginning of the chapter as `<WIDGET>_CreateUser()` on page 1162. For a detailed description of the parameters the function `BUTTON_CreateEx()` can be referred to.

### 7.2.5.5.1.6 BUTTON\_GetBitmap()

#### Description

Returns a pointer to the optional BUTTON bitmap.

#### Prototype

```
GUI_BITMAP *BUTTON_GetBitmap(BUTTON_Handle hObj,  
                             unsigned int  Index);
```

#### Parameters

Parameter	Description
<a href="#">hObj</a>	Handle of BUTTON widget.
<a href="#">Index</a>	See <i>BUTTON bitmap indexes</i> on page 1224 for a full list of permitted values.

#### Return value

Pointer to the bitmap, 0 if no bitmap exists.

#### Additional information

For details about how to set a button bitmap, refer to `BUTTON_SetBitmap()` and `BUTTON_SetBitmapEx()`.

### 7.2.5.5.1.7 BUTTON\_GetBkColor()

#### Description

Returns the background color of the given BUTTON widget.

#### Prototype

```
GUI_COLOR BUTTON_GetBkColor(BUTTON_Handle hObj,  
                             unsigned int  Index);
```

#### Parameters

Parameter	Description
<a href="#">hObj</a>	Handle of BUTTON widget.
<a href="#">Index</a>	See <i>BUTTON color indexes</i> on page 1225 for a full list of permitted values.

#### Return value

Background color of the given BUTTON widget.

### 7.2.5.5.1.8 BUTTON\_GetDefaultBkColor()

#### Description

Returns the default background color for BUTTON widgets.

#### Prototype

```
GUI_COLOR BUTTON_GetDefaultBkColor(unsigned Index);
```

#### Parameters

Parameter	Description
<a href="#">Index</a>	See <i>BUTTON color indexes</i> on page 1225 for a full list of permitted values.

#### Return value

Default background color for BUTTON widgets.

### 7.2.5.5.1.9 BUTTON\_GetDefaultFont()

#### Description

Returns the pointer to the font used to display the text of BUTTON widgets.

#### Prototype

```
GUI_FONT *BUTTON_GetDefaultFont(void);
```

#### Return value

Pointer to the font used to display the text of BUTTON widgets.

### 7.2.5.5.1.10 BUTTON\_GetDefaultTextAlign()

#### Description

Returns the default text alignment used to display the text of BUTTON widgets.

#### Prototype

```
int BUTTON_GetDefaultTextAlign(void);
```

#### Return value

Default text alignment used to display the text of BUTTON widgets.

### 7.2.5.5.1.11 BUTTON\_GetDefaultTextColor()

#### Description

Returns the default text color used to display the text of BUTTON widgets.

#### Prototype

```
GUI_COLOR BUTTON_GetDefaultTextColor(unsigned Index);
```

#### Parameters

Parameter	Description
<a href="#">Index</a>	See <i>BUTTON color indexes</i> on page 1225 for a full list of permitted values.

#### Return value

Default text alignment used to display the text of BUTTON widgets.

### 7.2.5.5.1.12 BUTTON\_GetFont()

#### Description

Returns a pointer to the font used to display the text of the given BUTTON widget.

#### Prototype

```
GUI_FONT *BUTTON_GetFont(BUTTON_Handle hObj);
```

#### Parameters

Parameter	Description
<a href="#">hObj</a>	Handle of BUTTON widget.

#### Return value

Pointer to the font used to display the text of the given BUTTON widget.



### 7.2.5.5.1.13 BUTTON\_GetText()

#### Description

Retrieves the text of the specified BUTTON widget.

#### Prototype

```
void BUTTON_GetText(BUTTON_Handle hObj,  
                   char * pBuffer,  
                   int MaxLen);
```

#### Parameters

Parameter	Description
<code>hObj</code>	Handle of BUTTON widget.
<code>pBuffer</code>	Pointer to buffer.
<code>MaxLen</code>	Size of buffer.

### 7.2.5.5.1.14 BUTTON\_GetTextAlign()

#### Description

Returns the alignment of the BUTTON text.

#### Prototype

```
int BUTTON_GetTextAlign(BUTTON_Handle hObj);
```

#### Parameters

Parameter	Description
<a href="#">hObj</a>	Handle of BUTTON widget.

#### Return value

Alignment of the BUTTON text.

### 7.2.5.5.1.15 BUTTON\_GetTextColor()

#### Description

Returns the text color of the given BUTTON widget.

#### Prototype

```
GUI_COLOR BUTTON_GetTextColor(BUTTON_Handle hObj,  
                               unsigned int  Index);
```

#### Parameters

Parameter	Description
<a href="#">hObj</a>	Handle of BUTTON widget.
<a href="#">Index</a>	See <i>BUTTON color indexes</i> on page 1225 for a full list of permitted values.

#### Return value

Text color of the given BUTTON widget.

### 7.2.5.5.1.16 **BUTTON\_GetUserData()**

#### **Description**

Prototype explained at the beginning of the chapter as `<WIDGET>_GetUserData()` on page 1165.

### 7.2.5.5.1.17 BUTTON\_IsPressed()

#### Description

Returns if the BUTTON is pressed or not.

#### Prototype

```
unsigned BUTTON_IsPressed(BUTTON_Handle hObj);
```

#### Parameters

Parameter	Description
<a href="#">hObj</a>	Handle of BUTTON widget.

#### Return value

- 1 if the button is pressed.
- 0 if the button is not pressed.

### 7.2.5.5.1.18 BUTTON\_SetBitmap()

#### Description

Sets the bitmap(s) to be used when displaying a specified BUTTON widget.

#### Prototype

```
void BUTTON_SetBitmap(    BUTTON_Handle  hObj,
                        unsigned int   Index,
                        const GUI_BITMAP * pBitmap);
```

#### Parameters

Parameter	Description
<a href="#">hObj</a>	Handle of BUTTON widget.
<a href="#">Index</a>	See <i>BUTTON bitmap indexes</i> on page 1224 for a full list of permitted values.
<a href="#">pBitmap</a>	Pointer to the bitmap structure.

#### Return value

If only a bitmap for the unpressed state is set the button will show it also when it is pressed or disabled. To deactivate a previously set bitmap, NULL has to be passed as [pBitmap](#).

### 7.2.5.5.1.19 BUTTON\_SetBitmapEx()

#### Description

Sets the bitmap(s) to be used when displaying a specified BUTTON widget.

#### Prototype

```
void BUTTON_SetBitmapEx(    BUTTON_Handle  hObj,
                          unsigned int   Index,
                          const GUI_BITMAP * pBitmap,
                          int            x,
                          int            y);
```

#### Parameters

Parameter	Description
<a href="#">hObj</a>	Handle of BUTTON widget.
<a href="#">Index</a>	See <i>BUTTON bitmap indexes</i> on page 1224 for a full list of permitted values.
<a href="#">pBitmap</a>	Pointer to the bitmap structure.
<a href="#">x</a>	X-position for the bitmap relative to the button.
<a href="#">y</a>	Y-position for the bitmap relative to the button.

#### Return value

If only a bitmap for the unpressed state is set the BUTTON widget will show it also when it is pressed or disabled.

### 7.2.5.5.1.20 BUTTON\_SetBkColor()

#### Description

Sets the background color of a BUTTON widget.

#### Prototype

```
void BUTTON_SetBkColor(BUTTON_Handle hObj,  
                      unsigned int  Index,  
                      GUI_COLOR     Color);
```

#### Parameters

Parameter	Description
<a href="#">hObj</a>	Handle of BUTTON widget.
<a href="#">Index</a>	See <i>BUTTON color indexes</i> on page 1225 for a full list of permitted values.
<a href="#">Color</a>	Background color to be set.



### 7.2.5.5.1.21 BUTTON\_SetBMP()

#### Description

Sets the bitmap to be displayed on the specified BUTTON widget.

#### Prototype

```
void BUTTON_SetBMP(      BUTTON_Handle  hObj,  
                        unsigned int   Index,  
                        const void     * pBitmap);
```

#### Parameters

Parameter	Description
<a href="#">hObj</a>	Handle of BUTTON widget.
<a href="#">Index</a>	See <i>BUTTON bitmap indexes</i> on page 1224 for a full list of permitted values.
<a href="#">pBitmap</a>	Pointer to bitmap file data.

#### Additional information

If a bitmap was set only for the unpressed state, it will be also displayed in pressed or disabled state. For additional information regarding bitmap files, refer to *BMP file support* on page 447.

### 7.2.5.5.1.22 BUTTON\_SetBMPEX()

#### Description

Sets the bitmap to be displayed at the specified position on the given BUTTON widget.

#### Prototype

```
void BUTTON_SetBMPEX(    BUTTON_Handle  hObj,
                        unsigned int   Index,
                        const void      * pBitmap,
                        int             x,
                        int             y);
```

#### Parameters

Parameter	Description
<code>hObj</code>	Handle of BUTTON widget.
<code>Index</code>	See <i>BUTTON bitmap indexes</i> on page 1224 for a full list of permitted values.
<code>pBitmap</code>	Pointer to bitmap file data
<code>x</code>	X-position for the bitmap relative to the button.
<code>y</code>	Y-position for the bitmap relative to the button.

#### Additional information

If only a bitmap for the unpressed state is set the BUTTON widget will show it also when it is pressed or disabled. For additional information regarding bitmap files, refer to *BMP file support* on page 447.

### 7.2.5.5.1.23 BUTTON\_SetDefaultBkColor()

#### Description

Sets the default background color used for BUTTON widgets.

#### Prototype

```
void BUTTON_SetDefaultBkColor(GUI_COLOR Color,  
                             unsigned Index);
```

#### Parameters

Parameter	Description
Color	Color to be used.
Index	See <i>BUTTON color indexes</i> on page 1225 for a full list of permitted values.

### 7.2.5.5.1.24 BUTTON\_SetDefaultFocusColor()

#### Note

This function is **deprecated** and only works in conjunction with the classic skin (`BUTTON_SetSkinClassic()`). Skinning props should be used instead which can be set via `BUTTON_SetSkinFlexProps()`.

#### Description

Sets the default focus rectangle color for BUTTON widgets.

#### Prototype

```
GUI_COLOR BUTTON_SetDefaultFocusColor(GUI_COLOR Color);
```

#### Parameters

Parameter	Description
<code>Color</code>	Default color to be used for BUTTON widgets.

#### Return value

Previous default focus rectangle color.

#### Additional information

For more information, refer to `BUTTON_SetFocusColor()`.

### 7.2.5.5.1.25 BUTTON\_SetDefaultFont()

#### Description

Sets a pointer to a GUI\_FONT structure used to display the text of BUTTON widgets.

#### Prototype

```
void BUTTON_SetDefaultFont(const GUI_FONT * pFont);
```

#### Parameters

Parameter	Description
<code>pFont</code>	Pointer to GUI_FONT structure to be used.

### 7.2.5.5.1.26 BUTTON\_SetDefaultTextAlign()

#### Description

Sets the default text alignment used to display the text of BUTTON widgets.

#### Prototype

```
void BUTTON_SetDefaultTextAlign(int Align);
```

#### Parameters

Parameter	Description
<code>Align</code>	Text alignment mode. List of flags can be found under <i>Text alignment flags</i> on page 286.

### 7.2.5.5.1.27 BUTTON\_SetDefaultTextColor()

#### Description

Sets the default text color used to display the text of BUTTON widgets.

#### Prototype

```
void BUTTON_SetDefaultTextColor(GUI_COLOR Color,  
                               unsigned Index);
```

#### Parameters

Parameter	Description
Color	Default text color to be used.
Index	See <i>BUTTON color indexes</i> on page 1225 for a full list of permitted values.

### 7.2.5.5.1.28 BUTTON\_SetFocusColor()

#### Note

This function is **deprecated** and only works in conjunction with the classic skin (`BUTTON_SetSkinClassic()`). Skinning props should be used instead which can be set via `BUTTON_SetSkinFlexProps()`.

Before	After
	

#### Description

Sets the color used to render the focus rectangle of the BUTTON widget.

#### Prototype

```
GUI_COLOR BUTTON_SetFocusColor(BUTTON_Handle hObj,
                               GUI_COLOR      Color);
```

#### Parameters

Parameter	Description
<code>hObj</code>	Handle of BUTTON widget.
<code>Color</code>	<code>Color</code> to be used for the focus rectangle.

#### Return value

Previous color of the focus rectangle.

#### Additional information

The focus rectangle is only visible if the widget has the input focus.



### 7.2.5.5.1.29 BUTTON\_SetFocusable()

#### Description

Sets the ability to receive the input focus.

#### Prototype

```
void BUTTON_SetFocusable(BUTTON_Handle hObj,  
                        int State);
```

#### Parameters

Parameter	Description
<a href="#">hObj</a>	Handle of BUTTON widget.
<a href="#">State</a>	See table below.

Permitted values for parameter <a href="#">Index</a>	
1	Button can receive the input focus
0	Button can't receive the input focus

### 7.2.5.5.1.30 BUTTON\_SetFont()

#### Description

Sets the font of the BUTTON widget.

#### Prototype

```
void BUTTON_SetFont(      BUTTON_Handle  hObj,  
                       const GUI_FONT  * pfont);
```

#### Parameters

Parameter	Description
<code>hObj</code>	Handle of BUTTON widget.
<code>pFont</code>	Pointer to the font.

#### Additional information

If no font is selected, `BUTTON_FONT_DEF` will be used.

### 7.2.5.5.1.31 BUTTON\_SetFrameColor()

#### Note

This function is **deprecated** and only works in conjunction with the classic skin (`BUTTON_SetSkinClassic()`). Skinning props should be used instead which can be set via `BUTTON_SetSkinFlexProps()`.

#### Description

Sets the color of BUTTON frame.

#### Prototype

```
void BUTTON_SetFrameColor(BUTTON_Handle hObj,  
                          GUI_COLOR     Color);
```

#### Parameters

Parameter	Description
<code>hObj</code>	Handle of BUTTON widget.
<code>Color</code>	<code>Color</code> of the frame.

### 7.2.5.5.1.32 BUTTON\_SetPressed()

#### Description

Sets the state of the button to pressed or unpressed.

#### Prototype

```
void BUTTON_SetPressed(BUTTON_Handle hObj,  
                       int           State);
```

#### Parameters

Parameter	Description
<code>hObj</code>	Handle of BUTTON widget.
<code>State</code>	<code>State</code> , 1 for pressed, 0 for unpressed

### 7.2.5.5.1.33 **BUTTON\_SetReactOnLevel()**

#### **Description**

Sets all BUTTON widgets to react on level changes of the PID.

#### **Prototype**

```
void BUTTON_SetReactOnLevel(void);
```

#### **Additional information**

Alternatively to this function the configuration option `BUTTON_REACT_ON_LEVEL` can be used.

### 7.2.5.5.1.34 **BUTTON\_SetReactOnTouch()**

#### **Description**

Sets all BUTTON widgets to react on touch events.

#### **Prototype**

```
void BUTTON_SetReactOnTouch(void);
```

#### **Additional information**

The default behavior of BUTTON widgets is reacting on touch events.

### 7.2.5.5.1.35 BUTTON\_SetStreamedBitmap()

#### Description

Sets the streamed bitmap(s) to be used when displaying a specified BUTTON widget.

#### Prototype

```
void BUTTON_SetStreamedBitmap(    BUTTON_Handle    hObj,
                                unsigned int    Index,
                                const GUI_BITMAP_STREAM * pBitmap);
```

#### Parameters

Parameter	Description
<a href="#">hObj</a>	Handle of BUTTON widget.
<a href="#">Index</a>	See <i>BUTTON bitmap indexes</i> on page 1224 for a full list of permitted values.
<a href="#">pBitmap</a>	Pointer to a bitmap stream.

#### Additional information

For details about streamed bitmaps, refer to *Drawing streamed bitmaps* on page 365.

#### Example

```
BUTTON_SetStreamedBitmap(hButton, BUTTON_CI_UNPRESSED, (const GUI_BITMAP_STREAM*)acImage);
```

### 7.2.5.5.1.36 BUTTON\_SetStreamedBitmapEx()

#### Description

Sets the streamed bitmap(s) to be used when displaying the specified BUTTON widget.

#### Prototype

```
void BUTTON_SetStreamedBitmapEx(    BUTTON_Handle    hObj,
                                   unsigned int         Index,
                                   const GUI_BITMAP_STREAM * pBitmap,
                                   int                   x,
                                   int                   y);
```

#### Parameters

Parameter	Description
<code>hObj</code>	Handle of BUTTON widget.
<code>Index</code>	See <i>BUTTON bitmap indexes</i> on page 1224 for a full list of permitted values.
<code>pBitmap</code>	Pointer to a bitmap stream.
<code>x</code>	X-position for the bitmap relative to the button.
<code>y</code>	Y-position for the bitmap relative to the button.

#### Additional information

For details about streamed bitmaps, refer to *Drawing streamed bitmaps* on page 365.



### 7.2.5.5.1.37 BUTTON\_SetText()

#### Description

Sets the text to be displayed on the BUTTON widget.

#### Prototype

```
int BUTTON_SetText(      BUTTON_Handle  hObj,  
                      const char      * s);
```

#### Parameters

Parameter	Description
<code>hObj</code>	Handle of BUTTON widget.
<code>s</code>	Text to display.

#### Return value

0        on success  
1        on error.

### 7.2.5.5.1.38 BUTTON\_SetTextAlign()

#### Description

Sets the text alignment of the BUTTON widget.

#### Prototype

```
void BUTTON_SetTextAlign(BUTTON_Handle hObj,  
                        int Align);
```

#### Parameters

Parameter	Description
<code>hObj</code>	Handle of BUTTON widget.
<code>Align</code>	Text alignment mode. List of flags can be found under <i>Text alignment flags</i> on page 286.

#### Additional information

The default value of the text alignment is `GUI_TA_HCENTER` | `GUI_TA_VCENTER`.

### 7.2.5.5.1.39 BUTTON\_SetTextColor()

#### Description

Sets the text color of the BUTTON widget.

#### Prototype

```
void BUTTON_SetTextColor(BUTTON_Handle hObj,  
                        unsigned int  Index,  
                        GUI_COLOR     Color);
```

#### Parameters

Parameter	Description
<a href="#">hObj</a>	Handle of BUTTON widget.
<a href="#">Index</a>	See <i>BUTTON color indexes</i> on page 1225 for a full list of permitted values.
<a href="#">Color</a>	Text color to be set.

#### 7.2.5.5.1.40 BUTTON\_SetTextOffset()

##### Description

Adjusts the position of the BUTTON text considering the current text alignment setting.

##### Prototype

```
void BUTTON_SetTextOffset(BUTTON_Handle hObj,  
                          int           xPos,  
                          int           yPos);
```

##### Parameters

Parameter	Description
<code>hObj</code>	Handle of BUTTON widget.
<code>xPos</code>	Offset to be used for the x-axis. Default is 0.
<code>yPos</code>	Offset to be used for the y-axis. Default is 0.

### 7.2.5.5.1.41 BUTTON\_SetToggleMode()

#### Description

Enables toggle mode for the BUTTON widget. With this mode enabled, the BUTTON toggles between the pressed and unpressed state each time it is clicked.

#### Prototype

```
void BUTTON_SetToggleMode(BUTTON_Handle hObj,  
                           int          OnOff);
```

#### Parameters

Parameter	Description
<code>hObj</code>	Handle of BUTTON widget.
<code>OnOff</code>	1 for enabling toggle mode, 0 for disabling it.

#### 7.2.5.5.1.42 **BUTTON\_SetUserData()**

##### **Description**

Prototype explained at the beginning of the chapter as `<WIDGET>_SetUserData()` on page 1166.

### 7.2.5.5.1.43 BUTTON\_Toggle()

#### Description

Toggles the state of the given BUTTON.

#### Prototype

```
int BUTTON_Toggle(BUTTON_Handle hObj);
```

#### Parameters

Parameter	Description
<code>hObj</code>	Handle of BUTTON widget.

#### Return value

- 1 Error occurred.
- 0 If state was set to unpressed.
- 1 If state was set to pressed.

## 7.2.5.5.2 Defines

### 7.2.5.5.2.1 BUTTON bitmap indexes

#### Description

Bitmap indexes for BUTTON widget.

#### Definition

```
#define BUTTON_BI_UNPRESSED    0
#define BUTTON_BI_PRESSED     1
#define BUTTON_BI_DISABLED    2
```

#### Symbols

Definition	Description
<a href="#">BUTTON_BI_UNPRESSED</a>	Bitmap for disabled state.
<a href="#">BUTTON_BI_PRESSED</a>	Bitmap for pressed state.
<a href="#">BUTTON_BI_DISABLED</a>	Bitmap for unpressed state.



### 7.2.5.5.2.2 BUTTON color indexes

#### Description

Color indexes for BUTTON widget.

#### Definition

```
#define BUTTON_CI_UNPRESSED    0
#define BUTTON_CI_PRESSED      1
#define BUTTON_CI_DISABLED     2
```

#### Symbols

Definition	Description
<a href="#">BUTTON_CI_UNPRESSED</a>	Color for disabled state.
<a href="#">BUTTON_CI_PRESSED</a>	Color for pressed state.
<a href="#">BUTTON_CI_DISABLED</a>	Color for unpressed state.

## 7.2.5.6 Examples

The `Sample` folder contains the following examples which show how the widget can be used:

- `WIDGET_ButtonRound.c`

Note that several other examples also make use of this widget and may also be helpful to get familiar with the widget.

### Screenshot of `WIDGET_ButtonRound.c`:

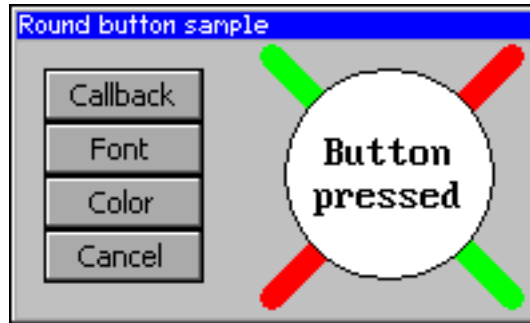

## 7.2.6 CHECKBOX: Checkbox widget

One of the most familiar widgets for selecting various choices is the check box. A check box may be checked or unchecked by the user, and any number of boxes may be checked at one time. If using a keyboard interface the state of a focused check box can be toggled by the <SPACE> key. A box will appear gray if it is disabled, as seen in the table below where each of the possible check box appearances are illustrated:

	Unchecked	Checked	Third state
Enabled	<input type="checkbox"/> Item A	<input checked="" type="checkbox"/> Item B	<input type="checkbox"/> Item C
Disabled	<input type="checkbox"/> Item D	<input checked="" type="checkbox"/> Item E	<input type="checkbox"/> Item F

### Note

All CHECKBOX-related routines are located in the file(s) CHECKBOX\*.c, CHECKBOX.h. All identifiers are prefixed CHECKBOX.

### Skinning...



...is available for this widget. The screenshot above shows the widget using the default skin. Details can be found in the chapter *Skinning* on page 2800.

### Note

This widget uses skinning. To change the look it is recommended to use the function <WIDGET>\_SetSkinFlexProps(). Other functions to change the look might work only with the classic skin.

### 7.2.6.1 Configuration options

Type	Macro	Default	Description
N	CHECKBOX_BKCOLOR_DEFAULT	0xC0C0C0	Default background color.
N	CHECKBOX_BKCOLOR0_DEFAULT	0x808080	Background color of the default image, disabled state.
N	CHECKBOX_BKCOLOR1_DEFAULT	GUI_WHITE	Background color of the default image, enabled state.
N	CHECKBOX_FGCOLOR0_DEFAULT	0x101010	Foreground color of the default image, disabled state.
N	CHECKBOX_FGCOLOR1_DEFAULT	GUI_BLACK	Foreground color of the default image, enabled state.
N	CHECKBOX_FOCUSCOLOR_DEFAULT	GUI_BLACK	Color used to render the focus rectangle.
S	CHECKBOX_FONT_DEFAULT	&GUI_Font13_1	Default font used to display the optional CHECKBOX text.
S	CHECKBOX_IMAGE0_DEFAULT	(see table above)	Pointer to bitmap used to draw the widget if checked, disabled state.
S	CHECKBOX_IMAGE1_DEFAULT	(see table above)	Pointer to bitmap used to draw the widget if checked, enabled state.

Type	Macro	Default	Description
N	CHECKBOX_SPACING_DEFAULT	4	Spacing used to display the optional CHECKBOX text beside the box.
N	CHECKBOX_TEXTALIGN_DEFAULT	GUI_TA_LEFT   GUI_TA_VCENTER	Default alignment of the optional CHECKBOX text.
N	CHECKBOX_TEXTCOLOR_DEFAULT	GUI_BLACK	Default color used to display the optional CHECKBOX text.

### 7.2.6.2 Predefined IDs

The following symbols define IDs which may be used to make CHECKBOX widgets distinguishable from creation.

```
#define GUI_ID_CHECK0    0x120
#define GUI_ID_CHECK1    0x121
#define GUI_ID_CHECK2    0x122
#define GUI_ID_CHECK3    0x123
#define GUI_ID_CHECK4    0x124
#define GUI_ID_CHECK5    0x125
#define GUI_ID_CHECK6    0x126
#define GUI_ID_CHECK7    0x127
#define GUI_ID_CHECK8    0x128
#define GUI_ID_CHECK9    0x129
```

### 7.2.6.3 Notification codes

The following events are sent from a check box widget to its parent window as part of a WM\_NOTIFY\_PARENT message:

Message	Description
WM_NOTIFICATION_CLICKED	CHECKBOX has been clicked.
WM_NOTIFICATION_RELEASED	CHECKBOX has been released.
WM_NOTIFICATION_MOVED_OUT	CHECKBOX has been clicked and pointer has been moved out of the box without releasing.
WM_NOTIFICATION_VALUE_CHANGED	Status of CHECKBOX has been changed.

### 7.2.6.4 Keyboard reaction

The widget reacts to the following keys if it has the input focus:

Message	Description
GUI_KEY_SPACE	Toggles the checked state of the CHECKBOX widget.

## 7.2.6.5 CHECKBOX API

The table below lists the available emWin CHECKBOX-related routines in alphabetical order. Detailed descriptions of the routines follow.

### Functions

Routine	Description
<code>CHECKBOX_Check()</code>	Set the state of CHECKBOX to checked. (Obsolete)
<code>CHECKBOX_Create()</code>	Creates a CHECKBOX widget. (Obsolete)
<code>CHECKBOX_CreateEx()</code>	Creates a CHECKBOX widget.
<code>CHECKBOX_CreateIndirect()</code>	Creates a CHECKBOX widget from resource table entry.
<code>CHECKBOX_CreateUser()</code>	Creates a CHECKBOX widget using extra bytes as user data.
<code>CHECKBOX_GetBkColor()</code>	Returns the currently set background color of the CHECKBOX widget.
<code>CHECKBOX_GetBoxBkColor()</code>	Returns the currently set background color used in the box of the CHECKBOX widget.
<code>CHECKBOX_GetDefaultAlign()</code>	Returns the default text alignment used for CHECKBOX widgets.
<code>CHECKBOX_GetDefaultBkColor()</code>	Returns the default background color of new CHECKBOX widgets.
<code>CHECKBOX_GetDefaultFont()</code>	Returns a pointer to a <code>GUI_FONT</code> structure used to display the text of new CHECKBOX widgets.
<code>CHECKBOX_GetDefaultSpacing()</code>	Returns the default spacing between box and text used to display the text of new CHECKBOX widgets.
<code>CHECKBOX_GetDefaultTextAlign()</code>	Returns the default alignment used to display the text of CHECKBOX widgets.
<code>CHECKBOX_GetDefaultTextColor()</code>	Returns the default text color used to display the text of new CHECKBOX widgets.
<code>CHECKBOX_GetFocusColor()</code>	This function returns the color currently used as focus color.
<code>CHECKBOX_GetFont()</code>	Returns the currently set font.
<code>CHECKBOX_GetImage()</code>	Returns the image set for the given index.
<code>CHECKBOX_GetState()</code>	Returns the current state of the given CHECKBOX widget.
<code>CHECKBOX_GetText()</code>	Returns the optional text of the given CHECKBOX widget.
<code>CHECKBOX_GetTextAlign()</code>	This function returns the text alignment of the given TEXT widget.
<code>CHECKBOX_GetTextColor()</code>	This function returns the color currently used the text.
<code>CHECKBOX_GetUserData()</code>	Retrieves the data set with <code>CHECKBOX_SetUserData()</code> .
<code>CHECKBOX_IsChecked()</code>	Returns the current state (checked or not checked) of a specified CHECKBOX widget.
<code>CHECKBOX_SetBkColor()</code>	Sets the background color used to display the background of the CHECKBOX widget.

Routine	Description
<code>CHECKBOX_SetBoxBkColor()</code>	Sets the background color of the box area. (Obsolete)
<code>CHECKBOX_SetDefaultAlign()</code>	Sets the default text alignment used for new CHECKBOX widgets.
<code>CHECKBOX_SetDefaultBkColor()</code>	Sets the default background color used for new CHECKBOX widgets.
<code>CHECKBOX_SetDefaultFocusColor()</code>	Sets the color used to render the focus rectangle of new CHECKBOX widgets.
<code>CHECKBOX_SetDefaultFont()</code>	Sets a pointer to a <code>GUI_FONT</code> structure used to display the text of new CHECKBOX widgets.
<code>CHECKBOX_SetDefaultImage()</code>	Sets the default image to be shown when a box has been checked.
<code>CHECKBOX_SetDefaultSpacing()</code>	Sets the default spacing between box and text used to display the text of new CHECKBOX widgets.
<code>CHECKBOX_SetDefaultTextAlign()</code>	Sets the default alignment used to display the text of CHECKBOX widgets.
<code>CHECKBOX_SetDefaultTextColor()</code>	Sets the default text color used to display the text of new CHECKBOX widgets.
<code>CHECKBOX_SetFocusColor()</code>	Sets the color of the focus rectangle.
<code>CHECKBOX_SetFont()</code>	Sets the font of the CHECKBOX widget.
<code>CHECKBOX_SetImage()</code>	Sets the image to be shown when CHECKBOX widget been checked.
<code>CHECKBOX_SetNumStates()</code>	Sets the number of possible states of the CHECKBOX widget (2 or 3).
<code>CHECKBOX_SetSpacing()</code>	Sets the spacing between the box and the check box text.
<code>CHECKBOX_SetState()</code>	Sets the state of the CHECKBOX widget.
<code>CHECKBOX_SetText()</code>	Sets the text of the CHECKBOX widget.
<code>CHECKBOX_SetTextAlign()</code>	Sets the alignment used to display the text of the CHECKBOX widget.
<code>CHECKBOX_SetTextColor()</code>	Sets the color used to display the text of the CHECKBOX widget.
<code>CHECKBOX_SetUserData()</code>	Sets the extra data of a CHECKBOX widget.
<code>CHECKBOX_Uncheck()</code>	Set the state of CHECKBOX to unchecked. (Obsolete)

## Defines

Group of defines	Description
<code>CHECKBOX_bitmap_indexes</code>	Bitmap indexes for CHECKBOX widget.
<code>CHECKBOX_color_indexes</code>	Color indexes for CHECKBOX widget.

## 7.2.6.5.1 Functions

### 7.2.6.5.1.1 CHECKBOX\_Check()

#### Note

This function is **deprecated**, `CHECKBOX_SetState()` should be used instead.

Before	After
<input type="checkbox"/> Item 1	<input checked="" type="checkbox"/> Item 1

#### Description

Sets the state of a specified CHECKBOX widget to checked.

#### Prototype

```
void CHECKBOX_Check(CHECKBOX_Handle hObj);
```

#### Parameters

Parameter	Description
<a href="#">hObj</a>	Handle of CHECKBOX widget.

### 7.2.6.5.1.2 CHECKBOX\_Create()

#### Note

This function is **deprecated**, `CHECKBOX_CreateEx()` should be used instead.

#### Description

Creates a CHECKBOX widget of a specified size at a specified location.

#### Prototype

```
CHECKBOX_Handle CHECKBOX_Create(int    x0,
                                int    y0,
                                int    xSize,
                                int    ySize,
                                WM_HWIN hParent,
                                int    Id,
                                int    Flags);
```

#### Parameters

Parameter	Description
<code>x0</code>	Leftmost pixel of the check box (in parent coordinates).
<code>y0</code>	Topmost pixel of the check box (in parent coordinates).
<code>xSize</code>	Horizontal size of the check box (in pixels).
<code>ySize</code>	Vertical size of the check box (in pixels).
<code>hParent</code>	Handle of parent window.
<code>Id</code>	ID to be returned.
<code>Flags</code>	Window create flags. Typically <code>WM_CF_SHOW</code> in order to make the widget visible immediately (refer to <i>Window create flags</i> on page 1146 for a list of available parameter values).

#### Return value

Handle of the created CHECKBOX widget; 0 if the function fails.

#### Additional information

If the parameters `xSize` or `ySize` are 0 the size of the bitmap will be used as default size of the check box.



### 7.2.6.5.1.3 CHECKBOX\_CreateEx()

#### Description

Creates a CHECKBOX widget of a specified size at a specified location.

#### Prototype

```
CHECKBOX_Handle CHECKBOX_CreateEx(int    x0,
                                   int    y0,
                                   int    xSize,
                                   int    ySize,
                                   WM_HWIN hParent,
                                   int    WinFlags,
                                   int    ExFlags,
                                   int    Id);
```

#### Parameters

Parameter	Description
<code>x0</code>	Leftmost pixel of the check box (in parent coordinates).
<code>y0</code>	Topmost pixel of the check box (in parent coordinates).
<code>xSize</code>	Horizontal size of the check box (in pixels).
<code>ySize</code>	Vertical size of the check box (in pixels).
<code>hParent</code>	Handle of parent window.
<code>WinFlags</code>	Window create flags. Typically <code>WM_CF_SHOW</code> in order to make the widget visible immediately (refer to <i>Window create flags</i> on page 1146 for a list of available parameter values).
<code>ExFlags</code>	Not used yet, reserved for future use.
<code>Id</code>	ID to be returned.

#### Return value

Handle of the created CHECKBOX widget; 0 if the function fails.

#### Additional information

If the parameters `xSize` or `ySize` are 0 the size of the default check mark bitmap (11 \* 11 pixels) plus the effect size will be used as default size of the check box. If the desired size of the check box is different to the default size it can be useful to set a user defined check mark image using the function `CHECKBOX_SetImage()`.

If check box text should be shown with the widget the size should be large enough to show the box + text + spacing between box and text.

#### 7.2.6.5.1.4 CHECKBOX\_CreateIndirect()

##### Description

The prototype of this function is explained at the beginning of this chapter. Details can be found in the description of the function `<WIDGET>_CreateIndirect()` on page 1161. The elements `Flags` and `Para` of the according `GUI_WIDGET_CREATE_INFO` structure are not used.

### 7.2.6.5.1.5 CHECKBOX\_CreateUser()

#### Description

Prototype explained at the beginning of the chapter as `<WIDGET>_CreateUser()` on page 1162. For a detailed description of the parameters the function `CHECKBOX_CreateEx()` can be referred to.

### 7.2.6.5.1.6 CHECKBOX\_GetBkColor()

#### Description

Returns the currently set background color of the CHECKBOX widget.

#### Prototype

```
GUI_COLOR CHECKBOX_GetBkColor(CHECKBOX_Handle hObj);
```

#### Parameters

Parameter	Description
<a href="#">hObj</a>	Handle of CHECKBOX widget.

#### Return value

The color currently used as background color.

### 7.2.6.5.1.7 CHECKBOX\_GetBoxBkColor()

#### Description

Returns the currently set background color used in the box of the CHECKBOX widget.

#### Prototype

```
GUI_COLOR CHECKBOX_GetBoxBkColor(CHECKBOX_Handle hObj,  
                                int Index);
```

#### Parameters

Parameter	Description
<a href="#">hObj</a>	Handle of CHECKBOX widget.
<a href="#">Index</a>	See <i>Checkbox color indexes</i> on page for a full list of permitted values.

#### Return value

Background color used for the corresponding state.

### 7.2.6.5.1.8 CHECKBOX\_GetDefaultAlign()

#### Description

Returns the default text alignment used for CHECKBOX widgets.

#### Prototype

```
int CHECKBOX_GetDefaultAlign(void);
```

#### Return value

Default text alignment. Refer to *Text alignment flags* on page 286 a list of permitted values.

### 7.2.6.5.1.9 CHECKBOX\_GetDefaultBkColor()

#### Description

Returns the default background color of new CHECKBOX widgets.

#### Prototype

```
GUI_COLOR CHECKBOX_GetDefaultBkColor(void);
```

#### Return value

Default background color of new CHECKBOX widgets.

#### Additional information

The background color returned by this function is not the background color shown in the box, but the background color of the rest of the widget.

For more information, refer to `CHECKBOX_SetBoxBkColor()`.

### 7.2.6.5.1.10 CHECKBOX\_GetDefaultFont()

#### Description

Returns a pointer to a `GUI_FONT` structure used to display the text of new `CHECKBOX` widgets.

#### Prototype

```
GUI_FONT *CHECKBOX_GetDefaultFont(void);
```

#### Return value

Pointer to a `GUI_FONT` structure used to display the text of new `CHECKBOX` widgets.

#### Additional information

For more information, refer to `CHECKBOX_SetFont()`.



### 7.2.6.5.1.11 CHECKBOX\_GetDefaultSpacing()

#### Description

Returns the default spacing between box and text used to display the text of new CHECKBOX widgets.

#### Prototype

```
int CHECKBOX_GetDefaultSpacing(void);
```

#### Return value

Default spacing between box and text used to display the text of new CHECKBOX widgets.

#### Additional information

For more information, refer to `CHECKBOX_SetSpacing()`.

### 7.2.6.5.1.12 CHECKBOX\_GetDefaultTextAlign()

#### Description

Returns the default alignment used to display the text of new CHECKBOX widgets.

#### Prototype

```
int CHECKBOX_GetDefaultAlign(void);
```

#### Return value

Default alignment used to display the text of new CHECKBOX widgets.

#### Additional information

For more information, refer to *CHECKBOX\_SetTextAlign()* on page 1270.

### 7.2.6.5.1.13 CHECKBOX\_GetDefaultTextColor()

#### Description

Returns the default text color used to display the text of new CHECKBOX widgets.

#### Prototype

```
GUI_COLOR CHECKBOX_GetDefaultTextColor(void);
```

#### Return value

Default text color used to display the text of new check box widgets.

#### Additional information

For more information, refer to `CHECKBOX_SetTextColor()`.

### 7.2.6.5.1.14 CHECKBOX\_GetFocusColor()

#### Description

This function returns the color currently used as focus color.

#### Prototype

```
GUI_COLOR CHECKBOX_GetFocusColor(CHECKBOX_Handle hObj);
```

#### Parameters

Parameter	Description
<a href="#">hObj</a>	Handle of CHECKBOX widget.

#### Return value

The color currently used to draw the focus.

### 7.2.6.5.1.15 CHECKBOX\_GetFont()

#### Description

Returns the currently set font.

#### Prototype

```
GUI_FONT *CHECKBOX_GetFont(CHECKBOX_Handle hObj);
```

#### Parameters

Parameter	Description
<a href="#">hObj</a>	Handle of CHECKBOX widget.

#### Return value

A pointer the font which is used for the CHECKBOX.

### 7.2.6.5.1.16 CHECKBOX\_GetImage()

#### Description

Returns the image set for the given index.

#### Prototype

```
GUI_BITMAP *CHECKBOX_GetImage(CHECKBOX_Handle hObj,  
                               unsigned int   Index);
```

#### Parameters

Parameter	Description
<a href="#">hObj</a>	Handle of CHECKBOX widget.
<a href="#">Index</a>	See <i>Checkbox bitmap indexes</i> on page <a href="#">1247</a> for a full list of permitted values.

#### Return value

A pointer the image used with the given index.

### 7.2.6.5.1.17 CHECKBOX\_GetState()

#### Description

Returns the current state of the given CHECKBOX widget.

#### Prototype

```
int CHECKBOX_GetState(CHECKBOX_Handle hObj);
```

#### Parameters

Parameter	Description
<a href="#">hObj</a>	Handle of CHECKBOX widget.

#### Return value

Current state of the given CHECKBOX widget.

#### Additional information

Per default a check box can have 2 states, checked (1) and unchecked (0). With the function `CHECKBOX_SetNumStates()` the number of possible states can be increased to 3. If the check box is in the third state the function returns 2.

For more information, refer to `CHECKBOX_SetNumStates()`.

### 7.2.6.5.1.18 CHECKBOX\_GetText()

#### Description

Returns the optional text of the given CHECKBOX widget.

#### Prototype

```
int CHECKBOX_GetText(CHECKBOX_Handle hObj,  
                    char * pBuffer,  
                    int MaxLen);
```

#### Parameters

Parameter	Description
<a href="#">hObj</a>	Handle of CHECKBOX widget.
<a href="#">pBuffer</a>	Pointer to buffer to which the text will be copied.
<a href="#">MaxLen</a>	Buffer size in bytes.

#### Return value

Length of the text copied into the buffer.

#### Additional information

If the CHECKBOX widget contains no text the function returns 0 and the buffer remains unchanged.



### 7.2.6.5.1.19 CHECKBOX\_GetTextAlign()

#### Description

This function returns the text alignment of the given TEXT widget.

#### Prototype

```
int CHECKBOX_GetTextAlign(CHECKBOX_Handle hObj);
```

#### Parameters

Parameter	Description
<a href="#">hObj</a>	Handle of CHECKBOX widget.

#### Return value

Returns the currently used text alignment.

### 7.2.6.5.1.20 CHECKBOX\_GetTextColor()

#### Description

This function returns the color currently used the text.

#### Prototype

```
GUI_COLOR CHECKBOX_GetTextColor(CHECKBOX_Handle hObj);
```

#### Parameters

Parameter	Description
<a href="#">hObj</a>	Handle of CHECKBOX widget.

#### Return value

The color currently used displaying the text.

### 7.2.6.5.1.21 CHECKBOX\_GetUserData()

#### Description

Prototype explained at the beginning of the chapter as `<WIDGET>_GetUserData()` on page 1165.

### 7.2.6.5.1.22 CHECKBOX\_IsChecked()

#### Description

Returns the current state (checked or not checked) of a specified CHECKBOX widget.

#### Prototype

```
int CHECKBOX_IsChecked(CHECKBOX_Handle hObj);
```

#### Parameters

Parameter	Description
<a href="#">hObj</a>	Handle of CHECKBOX widget.

#### Return value

0      not checked  
1      checked

### 7.2.6.5.1.23 CHECKBOX\_SetBkColor()

Before	After
<input type="checkbox"/> Item 1	<input type="checkbox"/> Item 1

#### Description

Sets the background color used to display the background of the CHECKBOX widget.

#### Prototype

```
void CHECKBOX_SetBkColor(CHECKBOX_Handle hObj,
                        GUI_COLOR      Color);
```

#### Parameters

Parameter	Description
<code>hObj</code>	Handle of CHECKBOX widget.
<code>Color</code>	<code>Color</code> to be used to draw the background or <code>GUI_INVALID_COLOR</code> to work in transparent mode.



#### Additional information

If the check box should work in transparent mode `GUI_INVALID_COLOR` should be used.

### 7.2.6.5.1.24 CHECKBOX\_SetBoxBkColor()

#### Note

This function is **deprecated** and only works in conjunction with the classic skin (`CHECKBOX_SetSkinClassic()`). Skinning props should be used instead which can be set via `CHECKBOX_SetSkinFlexProps()`.

Before	After
 Item 1	 Item 1

#### Description

Sets the background color of the box area.

#### Prototype

```
GUI_COLOR CHECKBOX_SetBoxBkColor(CHECKBOX_Handle hObj,
                                  GUI_COLOR      Color,
                                  int              Index);
```

#### Parameters

Parameter	Description
<code>hObj</code>	Handle of CHECKBOX widget.
<code>Color</code>	<code>Color</code> to be used.
<code>Index</code>	See <i>Checkbox color indexes</i> on page <a href="#">1254</a> for a full list of permitted values.

#### Return value

Previous background color.

#### Additional information

The color set by this function will only be visible, if the images used by the widget are transparent or no image is used. The default images of this widget are transparent.

### 7.2.6.5.1.25 CHECKBOX\_SetDefaultAlign()

#### Description

Sets the default text alignment used for new CHECKBOX widgets.

#### Prototype

```
void CHECKBOX_SetDefaultAlign(int Align);
```

#### Parameters

Parameter	Description
<a href="#">Align</a>	Text alignment flags. See <i>Text alignment flags</i> on page 286 for a full list of permitted values.

### 7.2.6.5.1.26 CHECKBOX\_SetDefaultBkColor()

#### Description

Sets the default background color used for new CHECKBOX widgets.

#### Prototype

```
void CHECKBOX_SetDefaultBkColor(GUI_COLOR Color);
```

#### Parameters

Parameter	Description
Color	Color to be used, GUI_INVALID_COLOR for transparency.

#### Additional information

For more information, refer to CHECKBOX\_SetBkColor.



### 7.2.6.5.1.27 CHECKBOX\_SetDefaultFocusColor()

#### Description

Sets the color used to render the focus rectangle of new CHECKBOX widgets.

#### Prototype

```
GUI_COLOR CHECKBOX_SetDefaultFocusColor(GUI_COLOR Color);
```

#### Parameters

Parameter	Description
Color	Color to be used.

#### Return value

Previous color used to render the focus rectangle.

#### Additional information

For more information, refer to `CHECKBOX_SetFocusColor()`.

### 7.2.6.5.1.28 CHECKBOX\_SetDefaultFont()

#### Description

Sets a pointer to a GUI\_FONT structure used to display the text of new CHECKBOX widgets.

#### Prototype

```
void CHECKBOX_SetDefaultFont(const GUI_FONT * pFont);
```

#### Parameters

Parameter	Description
<code>pFont</code>	Pointer to GUI_FONT structure to be used.

#### Additional information

For mode information, refer to CHECKBOX\_SetFont().

### 7.2.6.5.1.29 CHECKBOX\_SetDefaultImage()

#### Description

Sets the images used for new CHECKBOX widgets to be shown if they has been checked.

#### Prototype

```
void CHECKBOX_SetDefaultImage(const GUI_BITMAP * pBitmap,  
                             unsigned int   Index);
```

#### Parameters

Parameter	Description
<a href="#">pBitmap</a>	Pointer to bitmap.
<a href="#">Index</a>	See <i>Checkbox bitmap indexes</i> on page <a href="#">1258</a> for a full list of permitted values.

#### Additional information

The image has to fill the complete inner area of the CHECKBOX widget.

### 7.2.6.5.1.30 CHECKBOX\_SetDefaultSpacing()

#### Description

Sets the default spacing between box and text used to display the text of new CHECKBOX widgets.

#### Prototype

```
void CHECKBOX_SetDefaultSpacing(int Spacing);
```

#### Parameters

Parameter	Description
<code>Spacing</code>	Number of pixels between box and text used for new CHECKBOX widgets.

#### Additional information

For more information, refer to `CHECKBOX_SetSpacing()`.

### 7.2.6.5.1.31 CHECKBOX\_SetDefaultTextAlign()

#### Description

Sets the default alignment used to display the text of new CHECKBOX widgets.

#### Prototype

```
void CHECKBOX_SetDefaultTextAlign(int Align);
```

Parameter	Description
<code>Align</code>	Text alignment mode. List of flags can be found under <i>Text alignment flags</i> on page 286.

#### Additional information

For more information, refer to `CHECKBOX_SetTextAlign()` on page 1270.

### 7.2.6.5.1.32 CHECKBOX\_SetDefaultTextColor()

#### Description

Sets the default text color used to display the text of new CHECKBOX widgets.

#### Prototype

```
void CHECKBOX_SetDefaultTextColor(GUI_COLOR Color);
```



#### Parameters

Parameter	Description
Color	Color to be used.

#### Additional information

For more information, refer to CHECKBOX\_SetTextColor().

### 7.2.6.5.1.33 CHECKBOX\_SetFocusColor()

Before	After
	

#### Description

Sets the color used to render the focus rectangle.

#### Prototype

```
GUI_COLOR CHECKBOX_SetFocusColor(CHECKBOX_Handle hObj,
                                  GUI_COLOR      Color);
```

#### Parameters

Parameter	Description
<code>hObj</code>	Handle of CHECKBOX widget.
<code>Color</code>	<code>Color</code> to be used.

#### Return value

Previous color of the focus rectangle.

#### Additional information

The focus rectangle is only visible if the widget has the input focus.

### 7.2.6.5.1.34 CHECKBOX\_SetFont()

#### Description

Sets the font of the CHECKBOX widget.

#### Prototype





```
void CHECKBOX_SetFont(      CHECKBOX_Handle  hObj,  
                          const GUI_FONT    * pFont);
```

#### Parameters

Parameter	Description
<code>hObj</code>	Handle of CHECKBOX widget.
<code>pFont</code>	Pointer to the font.



### 7.2.6.5.1.35 CHECKBOX\_SetImage()

Before	After
 Item 1	 Item 1
 Item 1	 Item 1

#### Description

Sets the images to be shown if the CHECKBOX widget has been checked.

#### Prototype

```
void CHECKBOX_SetImage(    CHECKBOX_Handle  hObj,
                          const GUI_BITMAP  * pBitmap,
                          unsigned int      Index);
```

#### Parameters

Parameter	Description
<a href="#">hObj</a>	Handle of CHECKBOX widget.
<a href="#">pBitmap</a>	Pointer to bitmap.
<a href="#">Index</a>	See <i>CHECKBOX bitmap indexes</i> on page 1274 for a full list of permitted values.

#### Additional information

The image has to fill the complete inner area of the check box. If using this function make sure, the size of the check box used to create the widget is large enough to show the bitmap and (optional) the text.

### 7.2.6.5.1.36 CHECKBOX\_SetNumStates()

#### Description

This function sets the number of possible states of the given CHECKBOX widget.

#### Prototype

```
void CHECKBOX_SetNumStates(CHECKBOX_Handle hObj,  
                           unsigned NumStates);
```

#### Parameters

Parameter	Description
<code>hObj</code>	Handle of CHECKBOX widget.
<code>NumStates</code>	Number of possible states of the given check box. Currently supported are 2 or 3 states.

#### Additional information

Per default a check box supports 2 states: checked (1) and unchecked (0). If the check box should support a third state the number of possible states can be increased to 3.

### 7.2.6.5.1.37 CHECKBOX\_SetSpacing()

Before	After
<input type="checkbox"/> Item 1	<input type="checkbox"/> Item 1

#### Description

Sets the number of pixels between box and text of a given CHECKBOX widget.

#### Prototype

```
void CHECKBOX_SetSpacing(CHECKBOX_Handle hObj,
                        unsigned Spacing);
```

#### Parameters

Parameter	Description
<code>hObj</code>	Handle of CHECKBOX widget.
<code>Spacing</code>	Number of pixels between box and text to be used.

#### Additional information

The default spacing is 4 pixels. The function `CHECKBOX_SetDefaultSpacing()` or the configuration macro `CHECKBOX_SPACING_DEFAULT` can be used to set the default value.

### 7.2.6.5.1.38 CHECKBOX\_SetState()

Before	After
<input type="checkbox"/> Item 1	<input checked="" type="checkbox"/> Item 1 <input checked="" type="checkbox"/> Item 1

#### Description

Sets the new state of the given CHECKBOX widget.

#### Prototype

```
void CHECKBOX_SetState(CHECKBOX_Handle hObj,
                      unsigned State);
```

#### Parameters

Parameter	Description
<code>hObj</code>	Handle of CHECKBOX widget.
<code>State</code>	Zero-based number of new state.

Permitted values for parameter <code>State</code>	
0	Unchecked
1	Checked
2	Third state

#### Additional information

The passed state should not be greater than the number of possible states set with `CHECKBOX_SetNumStates()` minus 1.

### 7.2.6.5.1.39 CHECKBOX\_SetText()

Before	After
<input type="checkbox"/> 	<input type="checkbox"/> Item 1

#### Description

Sets the optional text shown beside the box.

#### Prototype

```
void CHECKBOX_SetText(    CHECKBOX_Handle  hObj,
                        const char      * s);
```

#### Parameters

Parameter	Description
<code>hObj</code>	Handle of CHECKBOX widget.
<code>s</code>	Pointer to text to be shown beside the box.

#### Additional information

Clicking on the text beside the box has the same effect as clicking into the box.

### 7.2.6.5.1.40 CHECKBOX\_SetTextAlign()

Before	After
<input checked="" type="checkbox"/> Item 1	<input checked="" type="checkbox"/> Item 1

#### Description

Sets the alignment used to display the text beside the box.

#### Prototype

```
void CHECKBOX_SetTextAlign(CHECKBOX_Handle hObj,
                          int Align);
```

#### Parameters

Parameter	Description
<code>hObj</code>	Handle of CHECKBOX widget.
<code>Align</code>	Text alignment mode. List of flags can be found under <i>Text alignment flags</i> on page 286.

#### Additional information

Per default the text alignment is `GUI_TA_LEFT` | `GUI_TA_VCENTER`. The function `CHECKBOX_SetDefaultTextAlign()` and the configuration macro `CHECKBOX_TEXTALIGN_DEFAULT` can be used to set a user defined default value.

### 7.2.6.5.1.41 CHECKBOX\_SetTextColor()

Before	After
<input checked="" type="checkbox"/> Item 1	<input checked="" type="checkbox"/> Item 1

#### Description

Sets the color used to display the text of the CHECKBOX widget.

#### Prototype

```
void CHECKBOX_SetTextColor(CHECKBOX_Handle hObj,
                          GUI_COLOR      Color);
```

#### Parameters

Parameter	Description
<code>hObj</code>	Handle of CHECKBOX widget.
<code>Color</code>	Desired color of check box text.

#### Additional information

Per default the text color of a check box text is `GUI_BLACK`. The function `CHECKBOX_SetDefaultTextColor()` and the configuration macro `CHECKBOX_TEXTCOLOR_DEFAULT` can be used to set a user defined default color.

#### 7.2.6.5.1.42 CHECKBOX\_SetUserData()

##### Description

Prototype explained at the beginning of the chapter as `<WIDGET>_SetUserData()` on page 1166.



### 7.2.6.5.1.43 CHECKBOX\_Uncheck()

#### Note

This function is **deprecated**, `CHECKBOX_SetState()` should be used instead.

Before	After
<input checked="" type="checkbox"/> Item 1	<input type="checkbox"/> Item 1

#### Description

Sets the state of a specified CHECKBOX widget to unchecked.

#### Prototype

```
void CHECKBOX_Uncheck(CHECKBOX_Handle hObj);
```

Parameter	Description
<code>hObj</code>	Handle of CHECKBOX widget.

#### Additional information

This is the default setting for CHECKBOX widgets.

## 7.2.6.5.2 Defines

### 7.2.6.5.2.1 CHECKBOX bitmap indexes

#### Description

Bitmap indexes for CHECKBOX widget.

#### Definition

```
#define CHECKBOX_BI_INACTIV_UNCHECKED 0
#define CHECKBOX_BI_ACTIV_UNCHECKED 1
#define CHECKBOX_BI_INACTIV_CHECKED 2
#define CHECKBOX_BI_ACTIV_CHECKED 3
#define CHECKBOX_BI_INACTIV_3STATE 4
#define CHECKBOX_BI_ACTIV_3STATE 5
```

#### Symbols

Definition	Description
CHECKBOX_BI_INACTIV_UNCHECKED	Bitmap displayed when the CHECKBOX is unchecked and disabled.
CHECKBOX_BI_ACTIV_UNCHECKED	Bitmap displayed when the CHECKBOX is unchecked and enabled.
CHECKBOX_BI_INACTIV_CHECKED	Bitmap displayed when the CHECKBOX is checked and disabled.
CHECKBOX_BI_ACTIV_CHECKED	Bitmap displayed when the CHECKBOX is checked and enabled.
CHECKBOX_BI_INACTIV_3STATE	Bitmap displayed when the CHECKBOX is in the third state and disabled.
CHECKBOX_BI_ACTIV_3STATE	Bitmap displayed when the CHECKBOX is in the third state and enabled.

### 7.2.6.5.2.2 CHECKBOX color indexes

#### Description

Color indexes for CHECKBOX widget.

#### Definition

```
#define CHECKBOX_CI_DISABLED    0
#define CHECKBOX_CI_ENABLED    1
```

#### Symbols

Definition	Description
<a href="#">CHECKBOX_CI_DISABLED</a>	Color used for disabled state.
<a href="#">CHECKBOX_CI_ENABLED</a>	Color used for enabled state.

### 7.2.6.6 Example

The `Sample` folder contains the following example which shows how the widget can be used:

- `WIDGET_Checkbox.c`

Note that several other examples also make use of this widget and may also be helpful to get familiar with the widget.

#### Screenshot of `WIDGET_Checkbox.c`:

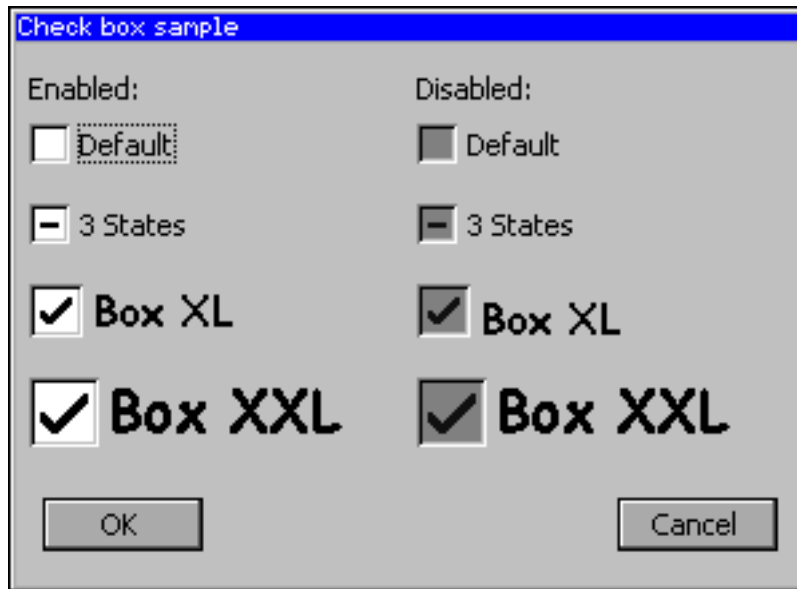

## 7.2.7 DROPDOWN: Dropdown widget

DROPDOWN widgets are used to select one element of a list with several columns. It shows the currently selected item in non open state. If the user opens a DROPDOWN widget a LISTBOX appears to select a new item.

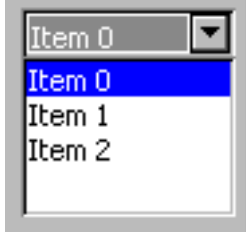
DROPDOWN closed	DROPDOWN opened
	

### Note

All DROPDOWN-related routines are located in the file(s) `DROPDOWN*.c`, `DROPDOWN.h`. All identifiers are prefixed `DROPDOWN`.

If mouse support is enabled, the open list reacts on moving the mouse over it.

### Skining...

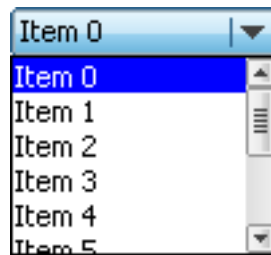

...is available for this widget. The screenshot above shows the widget using the default skin. Details can be found in the chapter *Skining* on page 2800.

### Note

This widget uses skinning. To change the look it is recommended to use the function `<WIDGET>_SetSkinFlexProps()`. Other functions to change the look might work only with the classic skin.

### 7.2.7.1 Configuration options

Type	Macro	Default	Description
N	<code>DROPDOWN_ALIGN_DEFAULT</code>	<code>GUI_TA_LEFT</code>	Text alignment used to display the dropdown text in closed state.
S	<code>DROPDOWN_FONT_DEFAULT</code>	<code>&amp;GUI_Font13_1</code>	Default font.
N	<code>DROPDOWN_BKCOLOR0_DEFAULT</code>	<code>GUI_WHITE</code>	Background color, unselected state.
N	<code>DROPDOWN_BKCOLOR1_DEFAULT</code>	<code>GUI_GRAY</code>	Background color, selected state without focus.
N	<code>DROPDOWN_BKCOLOR2_DEFAULT</code>	<code>GUI_BLUE</code>	Background color, selected state with focus.
N	<code>DROPDOWN_KEY_EXPAND</code>	<code>GUI_KEY_SPACE</code>	Key which can be used to expand the DROPDOWN list.

Type	Macro	Default	Description
N	DROPDOWN_KEY_SELECT	GUI_KEY_ENTER	Key which can be used to select an item from the open dropdown list.
N	DROPDOWN_TEXTCOLOR0_DEFAULT	GUI_BLACK	Text color, unselected state.
N	DROPDOWN_TEXTCOLOR1_DEFAULT	GUI_BLACK	Text color, selected state without focus.
N	DROPDOWN_TEXTCOLOR2_DEFAULT	GUI_WHITE	Enable 3D support.

### 7.2.7.2 Predefined IDs

The following symbols define IDs which may be used to make DROPDOWN widgets distinguishable from creation.

```
#define GUI_ID_DROPDOWN0    0x180
#define GUI_ID_DROPDOWN1    0x181
#define GUI_ID_DROPDOWN2    0x182
#define GUI_ID_DROPDOWN3    0x183
#define GUI_ID_DROPDOWN4    0x184
#define GUI_ID_DROPDOWN5    0x185
#define GUI_ID_DROPDOWN6    0x186
#define GUI_ID_DROPDOWN7    0x187
#define GUI_ID_DROPDOWN8    0x188
#define GUI_ID_DROPDOWN9    0x189
```

### 7.2.7.3 Notification codes

The following events are sent from the widget to its parent window as part of a WM\_NOTIFY\_PARENT message:

Message	Description
DROPDOWN_NOTIFICATION_COLLAPSED	DROPDOWN has been collapsed.
DROPDOWN_NOTIFICATION_EXPANDED	DROPDOWN has been expanded.
WM_NOTIFICATION_CLICKED	DROPDOWN has been clicked.
WM_NOTIFICATION_RELEASED	DROPDOWN has been released.
WM_NOTIFICATION_MOVED_OUT	DROPDOWN has been clicked and pointer has been moved out of the widget without releasing.
WM_NOTIFICATION_SCROLL_CHANGED	The scroll position of the optional scroll bar of the opened DROPDOWN widget has been changed.
WM_NOTIFICATION_SEL_CHANGED	The selection of the DROPDOWN list has been changed.

### 7.2.7.4 Keyboard reaction

The widget reacts to the following keys if it has the input focus:

Key	Reaction
GUI_KEY_ENTER	Selects an item from the open DROPDOWN list and closes the list.
GUI_KEY_SPACE	Opens the DROPDOWN list.

## 7.2.7.5 DROPDOWN API

The table below lists the available emWin DROPDOWN-related routines in alphabetical order. Detailed descriptions of the routines follow.

### Functions

Routine	Description
<code>DROPDOWN_AddString()</code>	Adds a new element to the DROPDOWN widget.
<code>DROPDOWN_Clear()</code>	Removes all text items from the DROPDOWN.
<code>DROPDOWN_Collapse()</code>	Closes the DROPDOWN list.
<code>DROPDOWN_Create()</code>	Creates a DROPDOWN widget. (Obsolete)
<code>DROPDOWN_CreateEx()</code>	Creates a DROPDOWN widget.
<code>DROPDOWN_CreateIndirect()</code>	Creates a DROPDOWN widget from a resource table entry.
<code>DROPDOWN_CreateUser()</code>	Creates a DROPDOWN widget using extra bytes as user data.
<code>DROPDOWN_DecSel()</code>	Decrements selection.
<code>DROPDOWN_DecSelExp()</code>	Decrements selection in expanded state.
<code>DROPDOWN_DeleteItem()</code>	Deletes the given item of the DROPDOWN widget.
<code>DROPDOWN_EnableMotion()</code>	Enables motion support for the given DROPDOWN widget.
<code>DROPDOWN_Expand()</code>	Opens the list of the DROPDOWN widget.
<code>DROPDOWN_GetBkColor()</code>	Returns the background color of the given DROPDOWN widget.
<code>DROPDOWN_GetColor()</code>	Returns the color used for either the button or the arrow.
<code>DROPDOWN_GetDefaultFont()</code>	Returns the default font of DROPDOWN widgets.
<code>DROPDOWN_GetFont()</code>	Returns the font currently used by the widget.
<code>DROPDOWN_GetItemDisabled()</code>	Returns the state of the given item.
<code>DROPDOWN_GetItemText()</code>	Returns the text of a specific item of the given DROPDOWN widget.
<code>DROPDOWN_GetListbox()</code>	Returns the handle of the attached LISTBOX widget in expanded state.
<code>DROPDOWN_GetNumItems()</code>	Returns the number of items in the given DROPDOWN widget.
<code>DROPDOWN_GetSel()</code>	Returns the number of the currently selected item in a specified DROPDOWN widget.
<code>DROPDOWN_GetSelExp()</code>	Returns the index of the currently selected item of the attached LISTBOX in expanded state.
<code>DROPDOWN_GetTextColor()</code>	Returns the color of the text.
<code>DROPDOWN_GetUserData()</code>	Retrieves the data set with <code>DROPDOWN_SetUserData()</code> .
<code>DROPDOWN_IncSel()</code>	Increments selection.

Routine	Description
<code>DROPDOWN_IncSelExp()</code>	Increments selection in expanded state.
<code>DROPDOWN_InsertString()</code>	Inserts a string to the DROPDOWN widget at the given position.
<code>DROPDOWN_SetAutoScroll()</code>	Enables the automatic use of a vertical scroll bar in the DROPDOWN widget.
<code>DROPDOWN_SetBkColor()</code>	Sets the background color of the given DROPDOWN widget.
<code>DROPDOWN_SetColor()</code>	Sets the color of the button or the arrow of the given DROPDOWN widget.
<code>DROPDOWN_SetDefaultColor()</code>	Sets the default colors for the arrow and the button of new DROPDOWN widgets.
<code>DROPDOWN_SetDefaultFont()</code>	Sets the default font used for new DROPDOWN widgets.
<code>DROPDOWN_SetDefaultScrollbarColor()</code>	Sets the default colors used for the optional scroll bar in the DROPDOWN widget.
<code>DROPDOWN_SetFont()</code>	Sets the font used to display the given DROPDOWN widget.
<code>DROPDOWN_SetItemDisabled()</code>	Sets the enabled state of the given item.
<code>DROPDOWN_SetItemSpacing()</code>	Sets an additional spacing below the items of the DROPDOWN widget.
<code>DROPDOWN_SetListHeight()</code>	Sets the height in pixels to be used for the expanded list of the DROPDOWN widget.
<code>DROPDOWN_SetScrollbarColor()</code>	Sets the colors of the optional scroll bar in the DROPDOWN widget.
<code>DROPDOWN_SetScrollbarWidth()</code>	Sets the width of the scroll bars used by the list of the given DROPDOWN widget.
<code>DROPDOWN_SetSel()</code>	Sets the current selection.
<code>DROPDOWN_SetSelExp()</code>	Sets the selected item of the attached LISTBOX in expanded state.
<code>DROPDOWN_SetText()</code>	Removes all text items from the DROPDOWN and replaces it with new text items.
<code>DROPDOWN_SetTextAlign()</code>	Sets the alignment used to display the text of the DROPDOWN widget in closed state.
<code>DROPDOWN_SetTextColor()</code>	Sets the text color of the given DROPDOWN widget.
<code>DROPDOWN_SetTextHeight()</code>	Sets the height of the rectangle used to display the dropdown text in closed state.
<code>DROPDOWN_SetUpMode()</code>	Enables opening of the list to the upper side of the DROPDOWN widget.
<code>DROPDOWN_SetUserData()</code>	Sets the extra data of a DROPDOWN widget.

## Defines

Group of defines	Description
<code>DROPDOWN color indexes</code>	Color indexes for DROPDOWN widget.
<code>DROPDOWN create flags</code>	Create flags for DROPDOWN widget.
<code>DROPDOWN notification codes</code>	Notification codes sent by DROPDOWN widget.



## 7.2.7.5.1 Functions

### 7.2.7.5.1.1 DROPDOWN\_AddString()

#### Description

Adds a new element to the DROPDOWN widget.

#### Prototype

```
void DROPDOWN_AddString(      DROPDOWN_Handle  hObj,  
                             const char      * s);
```

#### Parameters

Parameter	Description
<code>hObj</code>	Handle of DROPDOWN widget.
<code>s</code>	Pointer to string to be added

### 7.2.7.5.1.2 DROPDOWN\_Clear()

#### Description

Removes all text items from the DROPDOWN.

#### Prototype

```
void DROPDOWN_Clear(DROPDOWN_Handle hObj);
```

#### Parameters

Parameter	Description
<a href="#">hObj</a>	Handle of DROPDOWN widget.

### 7.2.7.5.1.3 DROPDOWN\_Collapse()

#### Description

Closes the dropdown list of the DROPDOWN widget.

#### Prototype

```
void DROPDOWN_Collapse(DROPDOWN_Handle hObj);
```

#### Parameters

Parameter	Description
<a href="#">hObj</a>	Handle of DROPDOWN widget.

### 7.2.7.5.1.4 DROPDOWN\_Create()

#### Note

This function is **deprecated**, `DROPDOWN_CreateEx()` should be used instead.

#### Description

Creates a DROPDOWN widget of a specified size at a specified location.

#### Prototype

```
DROPDOWN_Handle DROPDOWN_Create(WM_HWIN hWinParent,
                                int      x0,
                                int      y0,
                                int      xSize,
                                int      ySize,
                                int      Flags);
```

#### Parameters

Parameter	Description
<code>hWinParent</code>	Handle of parent window
<code>x0</code>	Leftmost pixel of the DROPDOWN widget (in parent coordinates).
<code>y0</code>	Topmost pixel of the DROPDOWN widget (in parent coordinates).
<code>xSize</code>	Horizontal size of the DROPDOWN widget (in pixels).
<code>ySize</code>	Vertical size of the DROPDOWN widget in open state (in pixels).
<code>Flags</code>	Window create flags. Typically, <code>WM_CF_SHOW</code> to make the widget visible immediately (refer to <i>Window create flags</i> on page 1146 for a list of available parameter values).

#### Return value

Handle of the created DROPDOWN widget; 0 if the function fails.

#### Additional information

The `ySize` of the widget in closed state depends on the font used to create the widget. You can not set the `ySize` of a closed DROPDOWN widget.

### 7.2.7.5.1.5 DROPDOWN\_CreateEx()

#### Description

Creates a DROPDOWN widget of a specified size at a specified location.

#### Prototype

```
DROPDOWN_Handle DROPDOWN_CreateEx(int    x0,
                                     int    y0,
                                     int    xSize,
                                     int    ySize,
                                     WM_HWIN hParent,
                                     int    WinFlags,
                                     int    ExFlags,
                                     int    Id);
```

#### Parameters

Parameter	Description
<code>x0</code>	Leftmost pixel of the DROPDOWN widget (in parent coordinates).
<code>y0</code>	Topmost pixel of the DROPDOWN widget (in parent coordinates).
<code>xSize</code>	Horizontal size of the DROPDOWN widget (in pixels).
<code>ySize</code>	Vertical size of the DROPDOWN widget in open state (in pixels).
<code>hParent</code>	Handle of parent window. If 0, the new DROPDOWN widget will be a child of the desktop (top-level window).
<code>WinFlags</code>	Window create flags. Typically <code>WM_CF_SHOW</code> in order to make the widget visible immediately (refer to <i>Window create flags</i> on page 1146 for a list of available parameter values).
<code>ExFlags</code>	See <i>DROPDOWN create flags</i> on page 1329.
<code>Id</code>	Window ID of the widget.

#### Return value

Handle of the created DROPDOWN widget; 0 if the function fails.

### 7.2.7.5.1.6 DROPDOWN\_CreateIndirect()

#### Description

The prototype of this function is explained at the beginning of this chapter. Details can be found in the description of the function `<WIDGET>_CreateIndirect()` on page 1161. The element `Para` of the according `GUI_WIDGET_CREATE_INFO` structure is not used. The element `Flags` is used according to the parameter `ExFlags` of the function `DROPDOWN_CreateEx()`.

### 7.2.7.5.1.7 DROPDOWN\_CreateUser()

#### Description

Prototype explained at the beginning of the chapter as `<WIDGET>_CreateUser()` on page 1162. For a detailed description of the parameters the function `DROPDOWN_CreateEx()` can be referred to.

### 7.2.7.5.1.8 DROPDOWN\_DecSel()

#### Description

Decrement the selection, moves the selection of a specified DROPDOWN widget up by one item.

#### Prototype

```
void DROPDOWN_DecSel(DROPDOWN_Handle hObj);
```

#### Parameters

Parameter	Description
<code>hObj</code>	Handle of DROPDOWN widget



### 7.2.7.5.1.9 DROPDOWN\_DecSelExp()

#### Description

Decrements the selection of the attached LISTBOX in expanded state.

#### Prototype

```
void DROPDOWN_DecSelExp(DROPDOWN_Handle hObj);
```

#### Parameters

Parameter	Description
<a href="#">hObj</a>	Handle of DROPDOWN widget

### 7.2.7.5.1.10 DROPDOWN\_DeleteItem()

#### Description

Deletes the given item of the DROPDOWN widget.

#### Prototype

```
void DROPDOWN_DeleteItem(DROPDOWN_Handle hObj,  
                          unsigned int   Index);
```

#### Parameters

Parameter	Description
<code>hObj</code>	Handle of DROPDOWN widget.
<code>Index</code>	Zero based index of the item to be deleted.

#### Additional information

If the index is greater than the number of items  $< 1$  the function returns immediately.

### 7.2.7.5.1.11 DROPDOWN\_EnableMotion()

#### Description

Enables motion support for the given DROPDOWN widget.

#### Prototype

```
void DROPDOWN_EnableMotion(DROPDOWN_Handle hObj,  
                           int             Flags);
```

#### Parameters

Parameter	Description
<code>hObj</code>	Handle of DROPDOWN widget.
<code>Flags</code>	DROPDOWN_CF_MOTION for motion support on vertical axis, 0 for disabling.

#### Additional information

If motion support isn't enabled for the window manager, it will be activated automatically.

Note that motion support cannot be used in conjunction with scrollbars. This means that enabling motion support on one axis will remove a scrollbar attached to the same axis.

### 7.2.7.5.1.12 DROPDOWN\_Expand()

#### Description

Opens the list of the DROPDOWN widget.

#### Prototype

```
void DROPDOWN_Expand(DROPDOWN_Handle hObj);
```

#### Parameters

Parameter	Description
<a href="#">hObj</a>	Handle of DROPDOWN widget.

#### Additional information

The DROPDOWN list remains open until an element has been selected or the focus has been lost.

### 7.2.7.5.1.13 DROPDOWN\_GetBkColor()

#### Description

Returns the background color of the given DROPDOWN widget.

#### Prototype

```
GUI_COLOR DROPDOWN_GetBkColor(DROPDOWN_Handle hObj,  
                               unsigned int    Index);
```

#### Parameters

Parameter	Description
<a href="#">hObj</a>	Handle of DROPDOWN widget.
<a href="#">Index</a>	<a href="#">Index</a> for background color. See <i>DROPDOWN color indexes</i> on page 1328 for a full list of permitted values.

#### Return value

The background color used with the corresponding index value.

### 7.2.7.5.1.14 DROPDOWN\_GetColor()

#### Description

Returns the color used for either the button or the arrow.

#### Prototype

```
GUI_COLOR DROPDOWN_GetColor(DROPDOWN_Handle hObj,
                             unsigned int   Index);
```

#### Parameters

Parameter	Description
<a href="#">hObj</a>	Handle of DROPDOWN widget.
<a href="#">Index</a>	<a href="#">Index</a> for background color. See table below.

Permitted values for parameter <a href="#">Index</a>	
DROPDOWN_CI_ARROW	Color of small arrow within the button.
DROPDOWN_CI_BUTTON	Button color.

#### Return value

The color of the button or the arrow.

### 7.2.7.5.1.15 DROPDOWN\_GetDefaultFont()

#### Description

Returns the default font of DROPDOWN widgets.

#### Prototype

```
GUI_FONT *DROPDOWN_GetDefaultFont(void);
```

#### Return value

Returns a pointer to the default font used by DROPDOWN widgets.

### 7.2.7.5.1.16 DROPDOWN\_GetFont()

#### Description

Returns the font currently used by the widget.

#### Prototype

```
GUI_FONT *DROPDOWN_GetFont(DROPDOWN_Handle hObj);
```

#### Parameters

Parameter	Description
<a href="#">hObj</a>	Handle of DROPDOWN widget

#### Return value

A pointer to the currently set font.



### 7.2.7.5.1.17 DROPDOWN\_GetItemDisabled()

#### Description

Returns the state of the given item.

#### Prototype

```
unsigned DROPDOWN_GetItemDisabled(DROPDOWN_Handle hObj,  
                                  unsigned Index);
```

#### Parameters

Parameter	Description
<code>hObj</code>	Handle of DROPDOWN widget
<code>Index</code>	Zero-based index of the item.

#### Return value

1 if the given item is disabled  
0 if not.

### 7.2.7.5.1.18 DROPDOWN\_GetItemText()

#### Description

Returns the text of a specific item of the given DROPDOWN widget.

#### Prototype

```
int DROPDOWN_GetItemText(DROPDOWN_Handle hObj,  
                        unsigned Index,  
                        char * pBuffer,  
                        int MaxSize);
```

#### Parameters

Parameter	Description
<a href="#">hObj</a>	Handle of DROPDOWN widget
<a href="#">Index</a>	Zero-based index of the item.
<a href="#">pBuffer</a>	Pointer to a char buffer which is filled with the text.
<a href="#">MaxSize</a>	Maximum number of chars which can be stored by <a href="#">pBuffer</a> .

#### Return value

0 on success  
1 on error.

### 7.2.7.5.1.19 DROPDOWN\_GetListbox()

#### Description

Returns the handle of the attached LISTBOX widget in expanded state.

#### Prototype

```
LISTBOX_Handle DROPDOWN_GetListbox(DROPDOWN_Handle hObj);
```

#### Parameters

Parameter	Description
<a href="#">hObj</a>	Handle of DROPDOWN widget.

#### Return value

Handle of the attached LISTBOX widget in expanded state, 0 if DROPDOWN is in collapsed state.

### 7.2.7.5.1.20 DROPDOWN\_GetNumItems()

#### Description

Returns the number of items in the given DROPDOWN widget.

#### Prototype

```
int DROPDOWN_GetNumItems(DROPDOWN_Handle hObj);
```

#### Parameters

Parameter	Description
<a href="#">hObj</a>	Handle of DROPDOWN widget.

#### Return value

Number of items in the given DROPDOWN widget.

### 7.2.7.5.1.21 DROPDOWN\_GetSel()

#### Description

Returns the number of the currently selected item in a specified DROPDOWN widget.

#### Prototype

```
int DROPDOWN_GetSel(DROPDOWN_Handle hObj);
```

#### Parameters

Parameter	Description
<a href="#">hObj</a>	Handle of DROPDOWN widget.

#### Return value

Number of the currently selected item.

### 7.2.7.5.1.22 DROPDOWN\_GetSelExp()

#### Description

Returns the index of the currently selected item of the attached LISTBOX in expanded state.

#### Prototype

```
int DROPDOWN_GetSelExp(DROPDOWN_Handle hObj);
```

#### Parameters

Parameter	Description
<a href="#">hObj</a>	Handle of DROPDOWN widget.

#### Return value

Index of the currently selected item.

### 7.2.7.5.1.23 DROPDOWN\_GetTextColor()

#### Description

Returns the color used for text to be displayed.

#### Prototype

```
GUI_COLOR DROPDOWN_GetTextColor(DROPDOWN_Handle hObj,  
                                unsigned int    Index);
```

#### Parameters

Parameter	Description
<a href="#">hObj</a>	Handle of DROPDOWN widget.
<a href="#">Index</a>	<a href="#">Index</a> for background color. See <i>DROPDOWN color indexes</i> on page 1328 for a full list of permitted values.

#### Return value

The color of the text corresponding to the given index.

#### 7.2.7.5.1.24 DROPDOWN\_GetUserData()

##### **Description**

Prototype explained at the beginning of the chapter as `<WIDGET>_GetUserData()` on page 1165.



### 7.2.7.5.1.25 DROPDOWN\_IncSel()

#### Description

Increment the selection, moves the selection of a specified DROPDOWN widget down by one item.

#### Prototype

```
void DROPDOWN_IncSel(DROPDOWN_Handle hObj);
```

#### Parameters

Parameter	Description
<a href="#">hObj</a>	Handle of DROPDOWN widget.

### 7.2.7.5.1.26 DROPDOWN\_IncSelExp()

#### Description

Increments the selection of the attached LISTBOX in expanded state.

#### Prototype

```
void DROPDOWN_IncSelExp(DROPDOWN_Handle hObj);
```

#### Parameters

Parameter	Description
<a href="#">hObj</a>	Handle of DROPDOWN widget.

### 7.2.7.5.1.27 DROPDOWN\_InsertString()

#### Description

Inserts a string to the DROPDOWN widget at the given position.

#### Prototype

```
void DROPDOWN_InsertString(DROPDOWN_Handle hObj,  
                           const char * s,  
                           unsigned int Index);
```

#### Parameters

Parameter	Description
<a href="#">hObj</a>	Handle of DROPDOWN widget.
<a href="#">s</a>	Pointer to the string to be inserted.
<a href="#">Index</a>	Zero based index of the position.

#### Additional information

If the given index is greater than the number of items the string will be appended to the end of the dropdown list.

### 7.2.7.5.1.28 DROPDOWN\_SetAutoScroll()

#### Description

Enables the automatic use of a vertical scroll bar in the DROPDOWN widget.

#### Prototype

```
void DROPDOWN_SetAutoScroll(DROPDOWN_Handle hObj,
                           int OnOff);
```

#### Parameters

Parameter	Description
<code>hObj</code>	Handle of DROPDOWN widget.
<code>OnOff</code>	See table below.

Permitted values for parameter <code>OnOff</code>	
0	Disable automatic use of a scroll bar.
1	Enable automatic use of a scroll bar.

#### Additional information

If enabled the DROPDOWN widget checks if all elements fits into the listbox. If not a vertical scroll bar will be added.

### 7.2.7.5.1.29 DROPDOWN\_SetBkColor()

Before	After
	

#### Description

Sets the background color of the given DROPDOWN widget.

#### Prototype

```
void DROPDOWN_SetBkColor(DROPDOWN_Handle hObj,
                        unsigned int      Index,
                        GUI_COLOR         Color);
```

#### Parameters

Parameter	Description
<code>hObj</code>	Handle of DROPDOWN widget.
<code>Index</code>	<code>Index</code> for background color. See <i>DROPDOWN color indexes</i> on page 1328 for a full list of permitted values.
<code>Color</code>	<code>Color</code> to be set.

### 7.2.7.5.1.30 DROPDOWN\_SetColor()

Before	After
	

#### Description

Sets the color of the button or the arrow of the given DROPDOWN widget.

#### Prototype

```
void DROPDOWN_SetColor(DROPDOWN_Handle hObj,
                      unsigned int   Index,
                      GUI_COLOR      Color);
```

#### Parameters

Parameter	Description
<code>hObj</code>	Handle of DROPDOWN widget.
<code>Index</code>	<code>Index</code> of desired item. See table below.
<code>Color</code>	<code>Color</code> to be used.

Permitted values for parameter <code>Index</code>	
<code>DROPDOWN_CI_ARROW</code>	<code>Color</code> of small arrow within the button.
<code>DROPDOWN_CI_BUTTON</code>	Button color.

### 7.2.7.5.1.31 DROPDOWN\_SetDefaultColor()

#### Description

Sets the default colors for the arrow and the button of new DROPDOWN widgets.

#### Prototype

```
GUI_COLOR DROPDOWN_SetDefaultColor(int Index,  
GUI_COLOR Color);
```

#### Parameters

Parameter	Description
<a href="#">Index</a>	Refer to <a href="#">DROPDOWN_SetColor()</a> .
<a href="#">Color</a>	<a href="#">Color</a> to be used.

### 7.2.7.5.1.32 DROPDOWN\_SetDefaultFont()

#### Description

Sets the default font used for new DROPDOWN widgets.

#### Prototype

```
void DROPDOWN_SetDefaultFont(const GUI_FONT * pFont);
```

#### Parameters

Parameter	Description
<code>pFont</code>	Pointer to GUI_FONT structure.



### 7.2.7.5.1.33 DROPDOWN\_SetDefaultScrollbarColor()

#### Description

Sets the default colors used for the optional scroll bar in the DROPDOWN widget.

#### Prototype

```
GUI_COLOR DROPDOWN_SetDefaultScrollbarColor(int Index,  
                                             GUI_COLOR Color);
```

#### Parameters

Parameter	Description
<a href="#">Index</a>	Refer to <a href="#">DROPDOWN_SetScrollbarColor()</a> .
<a href="#">Color</a>	<a href="#">Color</a> to be used.

### 7.2.7.5.1.34 DROPDOWN\_SetFont()

#### Description

Sets the font used to display the given DROPDOWN widget.

#### Prototype

```
void DROPDOWN_SetFont(      DROPDOWN_Handle  hObj,  
                           const GUI_FONT    * pFont);
```

#### Parameters

Parameter	Description
<code>hObj</code>	Handle of DROPDOWN widget
<code>pFont</code>	Pointer to the font.

### 7.2.7.5.1.35 DROPDOWN\_SetItemDisabled()

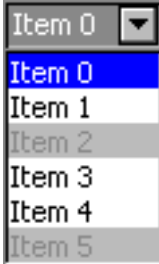
Before	After
	

#### Description

Sets the enabled state of the given item.

#### Prototype

```
void DROPDOWN_SetItemDisabled(DROPDOWN_Handle hObj,
                              unsigned Index,
                              int OnOff);
```

#### Parameters

Parameter	Description
<code>hObj</code>	Handle of DROPDOWN widget
<code>Index</code>	Zero-based index of the item.
<code>OnOff</code>	1 for enabled, 0 for disabled.

### 7.2.7.5.1.36 DROPDOWN\_SetItemSpacing()

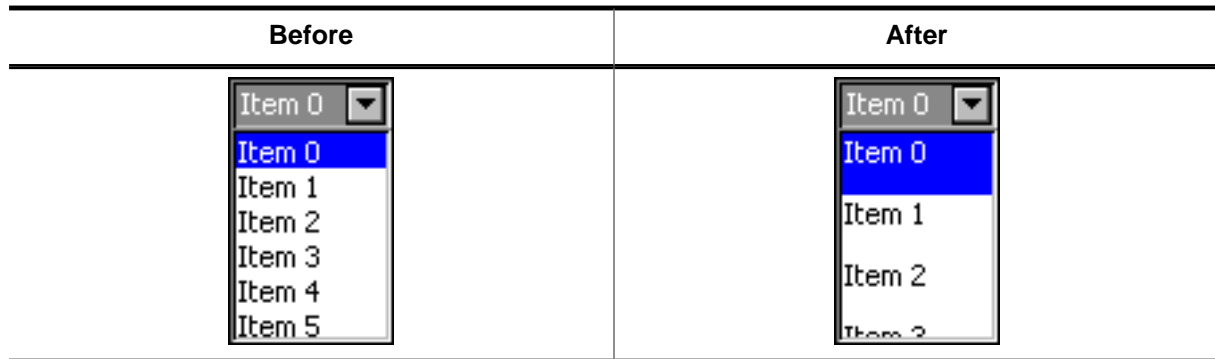

#### Description

Sets an additional spacing below the items of the DROPDOWN widget.

#### Prototype

```
void DROPDOWN_SetItemSpacing(DROPDOWN_Handle hObj,
                             unsigned Value);
```

#### Parameters

Parameter	Description
<code>hObj</code>	Handle of DROPDOWN widget
<code>Value</code>	Number of pixels used as additional space between the items of the DROPDOWN widget.

### 7.2.7.5.1.37 DROPDOWN\_SetListHeight()

#### Description

Sets the height in pixels to be used for the expanded list of the DROPDOWN widget.

#### Prototype

```
int DROPDOWN_SetListHeight(DROPDOWN_Handle hObj,  
                           unsigned        Height);
```

#### Parameters

Parameter	Description
<a href="#">hObj</a>	Handle of DROPDOWN widget
<a href="#">Height</a>	<a href="#">Height</a> to be used.

#### Return value

Previously used height for the DROPDOWN list in pixels.

### 7.2.7.5.1.38 DROPDOWN\_SetScrollbarColor()

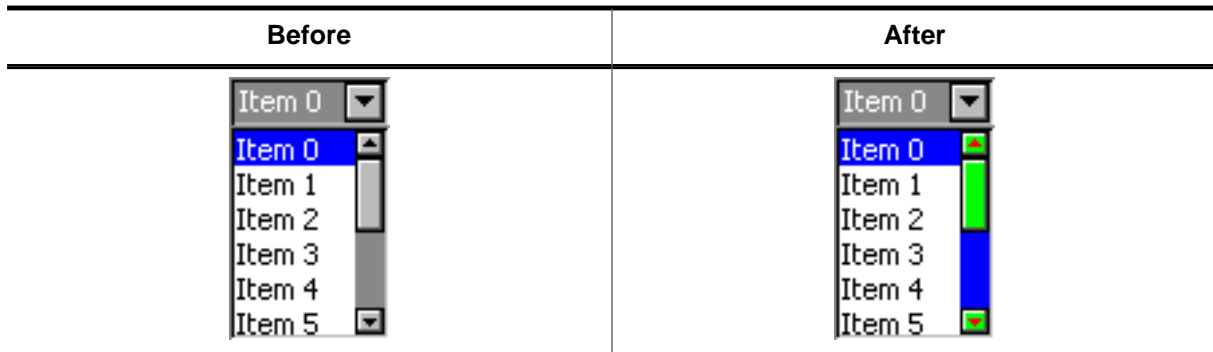

#### Description

Sets the colors of the optional scroll bar in the DROPDOWN widget.

#### Prototype

```
void DROPDOWN_SetScrollbarColor(DROPDOWN_Handle hObj,
                                unsigned Index,
                                GUI_COLOR Color);
```

#### Parameters

Parameter	Description
<code>hObj</code>	Handle of DROPDOWN widget
<code>Index</code>	<code>Index</code> of desired item. See <i>SCROLLBAR color indexes</i> on page 2212 for a full list of permitted values.
<code>Color</code>	<code>Color</code> to be used.

### 7.2.7.5.1.39 DROPDOWN\_SetScrollbarWidth()

#### Description

Sets the width of the scroll bars used by the list of the given DROPDOWN widget.

#### Prototype

```
void DROPDOWN_SetScrollbarWidth(DROPDOWN_Handle hObj,  
                                unsigned         Width);
```

#### Parameters

Parameter	Description
<code>hObj</code>	Handle of DROPDOWN widget
<code>Width</code>	<code>Width</code> of the scroll bar(s) used by the dropdown list of the given DROPDOWN widget.

#### 7.2.7.5.1.40 DROPDOWN\_SetSel()

##### Description

Sets the selected item of a specified DROPDOWN widget.

##### Prototype

```
void DROPDOWN_SetSel(DROPDOWN_Handle hObj,  
                    int Sel);
```

##### Parameters

Parameter	Description
<code>hObj</code>	Handle of DROPDOWN widget
<code>Sel</code>	Element to be selected.



### 7.2.7.5.1.41 DROPDOWN\_SetSelExp()

#### Description

Sets the selected item of the attached LISTBOX in expanded state.

#### Prototype

```
void DROPDOWN_SetSelExp(DROPDOWN_Handle hObj,  
                        int Sel);
```

#### Parameters

Parameter	Description
<code>hObj</code>	Handle of DROPDOWN widget
<code>Sel</code>	Element to be selected.

### 7.2.7.5.1.42 DROPDOWN\_SetText()

#### Description

Removes all text items from the DROPDOWN and replaces it with new text items.

#### Prototype

```
void DROPDOWN_SetText(      DROPDOWN_Handle  hObj,  
                           const GUI_ConstString * ppText);
```

#### Parameters

Parameter	Description
<code>hObj</code>	Handle of DROPDOWN widget.
<code>ppText</code>	Pointer to an array of string pointers containing the elements to be displayed. Last element of the array must be <code>NULL</code> .

### 7.2.7.5.1.43 DROPDOWN\_SetTextAlign()

Before	After
	

#### Description

Sets the alignment used to display the text of the DROPDOWN widget in closed state.

#### Prototype

```
void DROPDOWN_SetTextAlign(DROPDOWN_Handle hObj,  
                           int Align);
```

#### Parameters

Parameter	Description
<code>hObj</code>	Handle of DROPDOWN widget
<code>Align</code>	Alignment used to display the dropdown text in closed state.

#### 7.2.7.5.1.44 DROPDOWN\_SetTextColor()

##### Description

Sets the background color of the given DROPDOWN widget.

##### Prototype

```
void DROPDOWN_SetTextColor(DROPDOWN_Handle hObj,  
                           unsigned int    Index,  
                           GUI_COLOR      Color);
```

##### Parameters

Parameter	Description
<a href="#">hObj</a>	Handle of DROPDOWN widget
<a href="#">Index</a>	<a href="#">Index</a> for background color. See <i>DROPDOWN color indexes</i> on page 1328 for a full list of permitted values.
<a href="#">Color</a>	<a href="#">Color</a> to be set.

### 7.2.7.5.1.45 DROPDOWN\_SetTextHeight()

Before	After
	

#### Description

Sets the height of the rectangle used to display the text of DROPDOWN widget in closed state.

#### Prototype

```
void DROPDOWN_SetTextHeight(DROPDOWN_Handle hObj,
                           unsigned TextHeight);
```

#### Parameters

Parameter	Description
hObj	Handle of DROPDOWN widget.
TextHeight	Height of the rectangle used to display the text in closed state.

#### Additional information

Per default the height of the DROPDOWN widget depends on the used font. Using this function with `TextHeight > 0` means the given value should be used. `TextHeight = 0` means the default behavior should be used.

### 7.2.7.5.1.46 DROPDOWN\_SetUpMode()

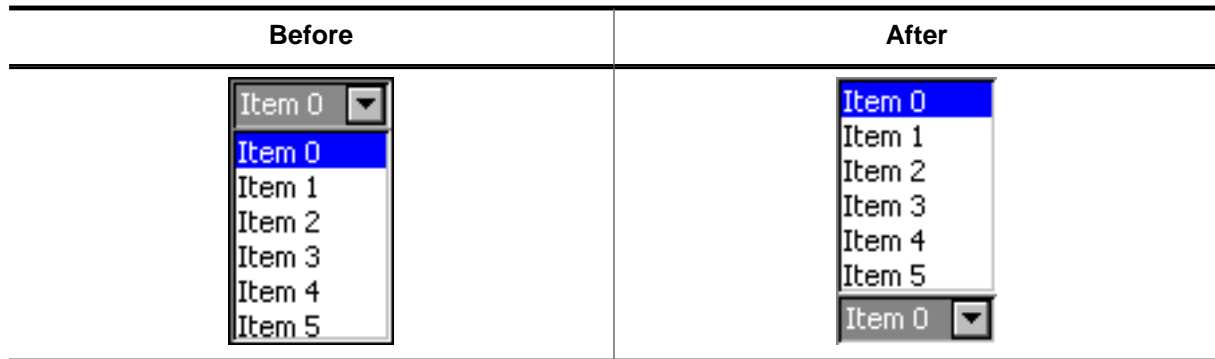

#### Description

Enables opening of the list to the upper side of the DROPDOWN widget.

#### Prototype

```
int DROPDOWN_SetUpMode(DROPDOWN_Handle hObj,
                       int OnOff);
```

#### Parameters

Parameter	Description
<code>hObj</code>	Handle of DROPDOWN widget
<code>OnOff</code>	1 for enabling, 0 for disabling 'up mode'.

### 7.2.7.5.1.47 DROPDOWN\_SetUserData()

#### Description

Prototype explained at the beginning of the chapter as `<WIDGET>_SetUserData()` on page 1166.

## 7.2.7.5.2 Defines

### 7.2.7.5.2.1 DROPDOWN color indexes

#### Description

Color indexes for DROPDOWN widget.

#### Definition

```
#define DROPDOWN_CI_UNSEL      0
#define DROPDOWN_CI_SEL      1
#define DROPDOWN_CI_SELFOCUS  2
```

#### Symbols

Definition	Description
<a href="#">DROPDOWN_CI_UNSEL</a>	Unselected element.
<a href="#">DROPDOWN_CI_SEL</a>	Selected element, without focus.
<a href="#">DROPDOWN_CI_SELFOCUS</a>	Selected element, with focus.



### 7.2.7.5.2.2 DROPDOWN create flags

#### Description

These flags can be used when creating a DROPDOWN widget via `DROPDOWN_CreateEx()`. 0 can be specified for the `ExFlags` parameter, if no flags should be used.

#### Definition

```
#define DROPDOWN_CF_AUTOSCROLLBAR    (1 << 0)
#define DROPDOWN_CF_UP               (1 << 1)
#define DROPDOWN_CF_MOTION          (1 << 2)
```

#### Symbols

Definition	Description
<code>DROPDOWN_CF_AUTOSCROLLBAR</code>	Enable automatic use of a scroll bar. For details, refer to <code>DROPDOWN_SetAutoScroll()</code> .
<code>DROPDOWN_CF_UP</code>	Creates a DROPDOWN widget which opens the dropdown list above the widget. This flag is useful if the space below the widget is not sufficient for the dropdown list.
<code>DROPDOWN_CF_MOTION</code>	Enables motion support on the vertical axis.

### 7.2.7.5.2.3 DROPDOWN notification codes

#### Description

Notifications sent by DROPDOWN widget to its parent widget through a WM\_NOTIFY\_PARENT message.

#### Definition

```
#define DROPDOWN_NOTIFICATION_EXPANDED    (WM_NOTIFICATION_WIDGET + 0)
#define DROPDOWN_NOTIFICATION_COLLAPSED  (WM_NOTIFICATION_WIDGET + 1)
```

#### Symbols

Definition	Description
<a href="#">DROPDOWN_NOTIFICATION_EXPANDED</a>	Sent when the list of the DROPDOWN has been expanded.
<a href="#">DROPDOWN_NOTIFICATION_COLLAPSED</a>	Sent when the list of the DROPDOWN has been collapsed.

### 7.2.7.6 Example

The `Sample` folder contains the following example which shows how the widget can be used:

- `WIDGET_Dropdown.c`



Note that several other examples also make use of this widget and may also be helpful to get familiar with the widget.

#### Screenshot of `WIDGET_Dropdown.c`:





## 7.2.8 EDIT: Edit widget

EDIT widgets are commonly used as the primary user interface for text input:

Blank EDIT widget	EDIT widget with user input
	

You can also use EDIT widgets for entering values in binary, decimal, or hexadecimal modes. A decimal-mode edit field might appear similar to those in the following table. The background color of EDIT widgets by default turns gray if disabled:

EDIT widget with user input (decimal)	Disabled EDIT widget
	

### Note

All EDIT-related routines are located in the file(s) `EDIT*.c`, `EDIT.h`.  
All identifiers are prefixed `EDIT`.

### 7.2.8.1 Configuration options

Type	Macro	Default	Description
S	<code>EDIT_ALIGN_DEFAULT</code>	<code>GUI_TA_LEFT</code>   <code>GUI_TA_VCENTER</code>	Text alignment for EDIT widget.
N	<code>EDIT_BKCOLOR0_DEFAULT</code>	<code>0xc0c0c0</code>	Background color, disabled state.
N	<code>EDIT_BKCOLOR1_DEFAULT</code>	<code>GUI_WHITE</code>	Background color, enabled state.
N	<code>EDIT_BORDER_DEFAULT</code>	<code>1</code>	Width of border, in pixels.
S	<code>EDIT_FONT_DEFAULT</code>	<code>&amp;GUI_Font13_1</code>	Font used for edit field text.
N	<code>EDIT_PASSWORD_CHAR_DEFAULT</code>	<code>'*'</code>	Default character used in password mode.
N	<code>EDIT_TEXTCOLOR0_DEFAULT</code>	<code>GUI_BLACK</code>	Text color, disabled state.
N	<code>EDIT_TEXTCOLOR1_DEFAULT</code>	<code>GUI_BLACK</code>	Text color, enabled state.
N	<code>EDIT_XOFF</code>	<code>1</code>	Distance in X to offset text from left border of EDIT widget.

Available alignment flags are:

- `GUI_TA_LEFT`, `GUI_TA_RIGHT`, `GUI_TA_HCENTER` for **horizontal** alignment.
- `GUI_TA_TOP`, `GUI_TA_BOTTOM`, `GUI_TA_VCENTER` for **vertical** alignment.

### 7.2.8.2 Predefined IDs

The following symbols define IDs which may be used to make EDIT widgets distinguishable from creation.

```
#define GUI_ID_EDIT0    0x100
#define GUI_ID_EDIT1    0x101
#define GUI_ID_EDIT2    0x102
#define GUI_ID_EDIT3    0x103
#define GUI_ID_EDIT4    0x104
#define GUI_ID_EDIT5    0x105
#define GUI_ID_EDIT6    0x106
#define GUI_ID_EDIT7    0x107
#define GUI_ID_EDIT8    0x108
#define GUI_ID_EDIT9    0x109
```

### 7.2.8.3 Notification codes

The following events are sent from an EDIT widget to its parent window as part of a WM\_NOTIFY\_PARENT message:

Message	Description
WM_NOTIFICATION_CLICKED	Widget has been clicked.
WM_NOTIFICATION_RELEASED	Widget has been released.
WM_NOTIFICATION_MOVED_OUT	Widget has been clicked and pointer has been moved out of the widget without releasing.
WM_NOTIFICATION_VALUE_CHANGED	Value (content) of the EDIT widget has changed.

### 7.2.8.4 Keyboard reaction

The widget reacts to the following keys if it has the input focus:

Key	Reaction
GUI_KEY_UP	Increases the current character. If for example the current character (the character below the cursor) is a 'A' it changes to 'B'.
GUI_KEY_DOWN	Decreases the current character. If for example the current character is a 'B' it changes to 'A'.
GUI_KEY_RIGHT	Moves the cursor one character to the right.
GUI_KEY_LEFT	Moves the cursor one character to the left.
GUI_KEY_BACKSPACE	If the widget works in text mode, the character before the cursor is deleted.
GUI_KEY_DELETE	If the widget works in text mode, the current is deleted.
GUI_KEY_INSERT	If the widget works in text mode, this key toggles the edit mode between GUI_EDIT_MODE_OVERWRITE and GUI_EDIT_MODE_INSERT. For details, refer to EDIT_SetInsertMode().
GUI_KEY_HOME	Moves the cursor to its first position.
GUI_KEY_END	Moves the cursor to its last position.

## 7.2.8.5 EDIT API

The table below lists the available emWin EDIT-related routines in alphabetical order. Detailed descriptions of the routines follow.

### Functions

Routine	Description
<code>EDIT_AddKey()</code>	Adds user input to a specified EDIT widget.
<code>EDIT_Create()</code>	Creates an EDIT widget. (Obsolete)
<code>EDIT_CreateAsChild()</code>	Creates an EDIT widget as a child window. (Obsolete)
<code>EDIT_CreateEx()</code>	Creates an EDIT widget.
<code>EDIT_CreateIndirect()</code>	Creates an EDIT widget from resource table entry.
<code>EDIT_CreateUser()</code>	Creates an EDIT widget using extra bytes as user data.
<code>EDIT_EnableAutoScroll()</code>	Toggles automatic text scrolling of the EDIT widget.
<code>EDIT_EnableBlink()</code>	Enables/disables a blinking cursor
<code>EDIT_EnableInversion()</code>	Enables/disables an inverted cursor (default is inverting)
<code>EDIT_GetBkColor()</code>	Returns the background color of the EDIT widget.
<code>EDIT_GetBorderSize()</code>	Returns the border size of an EDIT widget.
<code>EDIT_GetCharAtPixel()</code>	Returns the character at the given pixel position.
<code>EDIT_GetCursorCharPos()</code>	Returns the character related position of the cursor.
<code>EDIT_GetCursorPixelPos()</code>	Returns the pixel related position of the cursor in window coordinates.
<code>EDIT_GetDefaultBkColor()</code>	Returns the default background color used for EDIT widgets.
<code>EDIT_GetDefaultFont()</code>	Returns the default font used for EDIT widgets.
<code>EDIT_GetDefaultTextAlign()</code>	Returns the default text alignment used for EDIT widgets.
<code>EDIT_GetDefaultTextColor()</code>	Returns the default text color used for EDIT widgets.
<code>EDIT_GetFloatValue()</code>	Returns the current value of the EDIT widget as floating point value.
<code>EDIT_GetFont()</code>	Returns a pointer to the used font.
<code>EDIT_GetMinMax()</code>	This function is used to retrieve the minimum and maximum value set for the EDIT widget in decimal mode.
<code>EDIT_GetNumChars()</code>	Returns the number of characters of the specified EDIT widget.
<code>EDIT_GetSel()</code>	Returns the current selection.
<code>EDIT_GetSelText()</code>	Copies the selected text into a buffer.
<code>EDIT_GetText()</code>	Retrieves the user input of a specified EDIT widget.
<code>EDIT_GetTextAlign()</code>	This function returns the currently set alignment of the EDIT widget.
<code>EDIT_GetTextColor()</code>	Returns the text color.
<code>EDIT_GetUserData()</code>	Retrieves the data set with <code>EDIT_SetUserData()</code> .
<code>EDIT_GetValue()</code>	Returns the current value of the EDIT widget.
<code>EDIT_SetBinMode()</code>	Enables the binary edit mode of the EDIT widget.

Routine	Description
<code>EDIT_SetBkColor()</code>	Sets the background color of the EDIT widget.
<code>EDIT_SetBorderSize()</code>	Sets the border size of an EDIT widget.
<code>EDIT_SetCursorAtChar()</code>	Sets the EDIT widget cursor to a specified character position.
<code>EDIT_SetCursorAtPixel()</code>	Sets the EDIT widget cursor to a specified pixel position.
<code>EDIT_SetDecMode()</code>	Enables the decimal edit mode of the EDIT widget.
<code>EDIT_SetDefaultBkColor()</code>	Sets the default background color used for EDIT widgets.
<code>EDIT_SetDefaultFont()</code>	Sets the default font used for EDIT widgets.
<code>EDIT_SetDefaultTextAlign()</code>	Sets the default text alignment for EDIT widgets.
<code>EDIT_SetDefaultTextColor()</code>	Sets the default text color used for EDIT widgets.
<code>EDIT_SetFloatMode()</code>	Enables the floating point edit mode of the EDIT widget.
<code>EDIT_SetFloatValue()</code>	The function can be used to set the floating point value of the EDIT widget if working in floating point mode.
<code>EDIT_SetFocusable()</code>	Sets focusability of the EDIT widget.
<code>EDIT_SetFont()</code>	Sets the used font of the EDIT widget.
<code>EDIT_SetHexMode()</code>	Enables the hexadecimal edit mode of the EDIT widget.
<code>EDIT_SetInsertMode()</code>	Enables or disables the insert mode of the EDIT widget.
<code>EDIT_SetMaxLen()</code>	Sets the maximum number of characters to be edited by the given EDIT widget.
<code>EDIT_SetPasswordChar()</code>	Sets the global password character used for EDITS in password mode.
<code>EDIT_SetPasswordMode()</code>	Enables password mode for the given EDIT widget.
<code>EDIT_SetpfAddKeyEx()</code>	Sets a function which is called to add a character.
<code>EDIT_SetSel()</code>	Sets the current selection.
<code>EDIT_SetText()</code>	Sets the text.
<code>EDIT_SetTextAlign()</code>	Sets the text alignment of the EDIT widget.
<code>EDIT_SetTextColor()</code>	Sets the text color of the EDIT widget.
<code>EDIT_SetTextMode()</code>	Sets the edit mode of the EDIT widget back to text mode.
<code>EDIT_SetValue()</code>	Sets the current value of the EDIT widget.
<code>EDIT_SetUlongMode()</code>	Enables the unsigned long decimal edit mode of the EDIT widget.
<code>EDIT_SetUserData()</code>	Sets the extra data of an EDIT widget.

## Defines

Group of defines	Description
<code>EDIT_color_indexes</code>	Color indexes for EDIT widget.
<code>EDIT_flags</code>	Flags used for EDIT widgets.

## 7.2.8.5.1 Functions

### 7.2.8.5.1.1 EDIT\_AddKey()

#### Description

Adds user input to a specified EDIT widget.

#### Prototype

```
void EDIT_AddKey(EDIT_Handle hObj,  
                int         Key);
```

#### Parameters

Parameter	Description
<code>hObj</code>	Handle of EDIT widget
<code>Key</code>	Character to be added.

#### Additional information

The specified character is added to the user input of the EDIT widget. If the last character should be erased, the key `GUI_KEY_BACKSPACE` can be used. If the maximum count of characters has been reached, another character will not be added.



### 7.2.8.5.1.2 EDIT\_Create()

#### Note

This function is **deprecated**, `EDIT_CreateEx()` should be used instead.

#### Description

Creates an EDIT widget of a specified size at a specified location.

#### Prototype

```
EDIT_Handle EDIT_Create(int x0,
                      int y0,
                      int xSize,
                      int ySize,
                      int Id,
                      int MaxLen,
                      int Flags);
```

#### Parameters

Parameter	Description
<code>x0</code>	Leftmost pixel of the edit field (in parent coordinates).
<code>y0</code>	Topmost pixel of the edit field (in parent coordinates).
<code>xSize</code>	Horizontal size of the edit field (in pixels).
<code>ySize</code>	Vertical size of the edit field (in pixels).
<code>Id</code>	ID to be returned.
<code>MaxLen</code>	Maximum count of characters.
<code>Flags</code>	Window create flags. Typically <code>WM_CF_SHOW</code> in order to make the widget visible immediately (refer to <i>Window create flags</i> on page 1146 for a list of available parameter values).

#### Return value

Handle of the created EDIT widget; 0 if the function fails.

### 7.2.8.5.1.3 EDIT\_CreateAsChild()

#### Note

This function is **deprecated**, `EDIT_CreateEx()` should be used instead.

#### Description

Creates an EDIT widget as a child window.

#### Prototype

```
EDIT_Handle EDIT_CreateAsChild(int    x0,
                               int    y0,
                               int    xSize,
                               int    ySize,
                               WM_HWIN hParent,
                               int    Id,
                               int    Flags,
                               int    MaxLen);
```

#### Parameters

Parameter	Description
<code>x0</code>	X-position of the edit field relative to the parent window.
<code>y0</code>	Y-position of the edit field relative to the parent window.
<code>xSize</code>	Horizontal size of the edit field (in pixels).
<code>ySize</code>	Vertical size of the edit field (in pixels).
<code>hParent</code>	Handle of parent window.
<code>Id</code>	ID to be assigned to the EDIT widget.
<code>Flags</code>	Window create flags (see <i>Window create flags</i> on page 1146).
<code>MaxLen</code>	Maximum count of characters.

#### Return value

Handle of the created EDIT widget; 0 if the function fails.

### 7.2.8.5.1.4 EDIT\_CreateEx()

#### Description

Creates an EDIT widget of a specified size at a specified location.

#### Prototype

```
EDIT_Handle EDIT_CreateEx(int    x0,
                          int    y0,
                          int    xSize,
                          int    ySize,
                          WM_HWIN hParent,
                          int    WinFlags,
                          int    ExFlags,
                          int    Id,
                          int    MaxLen);
```

#### Parameters

Parameter	Description
<code>x0</code>	Leftmost pixel of the widget (in parent coordinates).
<code>y0</code>	Topmost pixel of the widget (in parent coordinates).
<code>xSize</code>	Horizontal size of the widget (in pixels).
<code>ySize</code>	Vertical size of the widget (in pixels).
<code>hParent</code>	Handle of parent window. If 0, the new EDIT widget will be a child of the desktop (top-level window).
<code>WinFlags</code>	Window create flags. Typically <code>WM_CF_SHOW</code> in order to make the widget visible immediately (refer to <i>Window create flags</i> on page 1146 for a list of available parameter values).
<code>ExFlags</code>	Not used, reserved for future use.
<code>Id</code>	Window ID of the widget.
<code>MaxLen</code>	Maximum count of characters.

#### Return value

Handle of the created EDIT widget; 0 if the function fails.

### 7.2.8.5.1.5 EDIT\_CreateIndirect()

#### Description

The prototype of this function is explained at the beginning of this chapter. Details can be found in the description of the function `<WIDGET>_CreateIndirect()` on page 1161. The element `Flags` is used according to the parameter `Align` of the function `EDIT_SetTextAlign()`. The element `Para` is used according to the parameter `MaxLen` of the function `EDIT_CreateEx()`.

### 7.2.8.5.1.6 EDIT\_CreateUser()

#### Description

Prototype explained at the beginning of the chapter as `<WIDGET>_CreateUser()` on page 1162. For a detailed description of the parameters the function `EDIT_CreateEx()` can be referred to.

### 7.2.8.5.1.7 EDIT\_EnableAutoScroll()

#### Description

Toggles automatic text scrolling of the EDIT widget. With this mode, when text is entered or deleted and the cursor moves out of the widget, the text is automatically scrolled so that the cursor remains visible.

#### Prototype

```
void EDIT_EnableAutoScroll(EDIT_Handle hObj,  
                           int         OnOff);
```

#### Parameters

Parameter	Description
<code>hObj</code>	Handle of EDIT widget.
<code>OnOff</code>	1 enables automatic scrolling, 0 disables it.

#### Additional information

Automatic text scrolling is enabled by default.

### 7.2.8.5.1.8 EDIT\_EnableBlink()

#### Description

Enables/disables a blinking cursor.

#### Prototype

```
void EDIT_EnableBlink(EDIT_Handle hObj,  
                     int         Period,  
                     int         OnOff);
```

#### Parameters

Parameter	Description
<code>hObj</code>	Handle of EDIT widget.
<code>Period</code>	Blinking period
<code>OnOff</code>	1 enables blinking, 0 disables blinking

#### Additional information

This function calls `GUI_X_GetTime()`.

### 7.2.8.5.1.9 EDIT\_EnableInversion()

#### Description

Toggles between inversion mode.

#### Prototype

```
int EDIT_EnableInversion(EDIT_Handle hObj,  
                        int          OnOff);
```

#### Parameters

Parameter	Description
<code>hObj</code>	Handle of EDIT widget.
<code>OnOff</code>	1 enables inverting, 0 disables inverting

#### Return value

Previous used mode.

0        No inversion.  
1        Inversion mode.

#### Additional information

The text cursor per default is drawn by inverting the character which is currently edited. If a cursor with a dedicated text- and background color is required, inversion can be deactivated and the functions `EDIT_SetTextColor()` and `EDIT_SetBkColor()` may be used for setting the cursor color.



### 7.2.8.5.1.10 EDIT\_GetBkColor()

#### Description

Returns the background color of the EDIT widget.

#### Prototype

```
GUI_COLOR EDIT_GetBkColor(EDIT_Handle hObj,  
                           unsigned int Index);
```

#### Parameters

Parameter	Description
<a href="#">hObj</a>	Handle of EDIT widget.
<a href="#">Index</a>	Color index. See <i>EDIT color indexes</i> on page 1392 for a full list of permitted values.

#### Return value

Background color of the EDIT widget.

### 7.2.8.5.1.11 EDIT\_GetBorderSize()

#### Description

Returns the border size of an EDIT widget.

#### Prototype

```
int EDIT_GetBorderSize(EDIT_Handle hObj);
```

#### Parameters

Parameter	Description
<a href="#">hObj</a>	Handle of EDIT widget.

#### Return value

= -1     Error.  
≠ -1     Border size of the EDIT widget.

### 7.2.8.5.1.12 EDIT\_GetCharAtPixel()

#### Description

Returns the character at the given pixel position.

#### Prototype

```
U16 EDIT_GetCharAtPixel(EDIT_Handle  hObj,  
                        int           x,  
                        int           y,  
                        int           * pIndex);
```

#### Parameters

Parameter	Description
<code>hObj</code>	Handle of EDIT widget.
<code>x</code>	X-position.
<code>y</code>	Y-position.
<code>pIndex</code>	Pointer to int. Zero-based position of the character in the string. Can be <code>NULL</code> if not needed.

#### Return value

- = 0      No character found.
- ≠ 0     The character at the given pixel position.

### 7.2.8.5.1.13 EDIT\_GetCursorCharPos()

#### Description

Returns the character related position of the cursor.

#### Prototype

```
int EDIT_GetCursorCharPos(EDIT_Handle hObj);
```

#### Parameters

Parameter	Description
<a href="#">hObj</a>	Handle of EDIT widget.

#### Return value

Character related position of the cursor.

#### Additional information

The widget returns the character position if it has the focus or not. This means the cursor position is also returned, if the cursor is currently not visible in the widget.

### 7.2.8.5.1.14 EDIT\_GetCursorPixelPos()

#### Description

Returns the pixel related position of the cursor in window coordinates.

#### Prototype

```
void EDIT_GetCursorPixelPos(EDIT_Handle  hObj,  
                           int          * pxPos,  
                           int          * pyPos);
```

#### Parameters

Parameter	Description
<code>hObj</code>	Handle of EDIT widget.
<code>pxPos</code>	Pointer to integer variable for the X-position in window coordinates.
<code>pyPos</code>	Pointer to integer variable for the Y-position in window coordinates.

#### Additional information

The widget returns the pixel position if it has the focus or not. This means the cursor position is also returned, if the cursor is currently not visible in the widget.

### 7.2.8.5.1.15 EDIT\_GetDefaultBkColor()

#### Description

Returns the default background color used for EDIT widgets.

#### Prototype

```
GUI_COLOR EDIT_GetDefaultBkColor(unsigned int Index);
```

#### Parameters

Parameter	Description
<a href="#">Index</a>	Color index. See table below.

#### Return value

Default background color used for EDIT widgets.

### 7.2.8.5.1.16 EDIT\_GetDefaultFont()

#### Description

Returns the default font used for EDIT widgets.

#### Prototype

```
GUI_FONT *EDIT_GetDefaultFont(void);
```

#### Return value

Default font used for EDIT widgets.

### 7.2.8.5.1.17 EDIT\_GetDefaultTextAlign()

#### Description

Returns the default text alignment used for EDIT widgets.

#### Prototype

```
int EDIT_GetDefaultTextAlign(void);
```

#### Return value

Default text alignment used for EDIT widgets.



### 7.2.8.5.1.18 EDIT\_GetDefaultTextColor()

#### Description

Returns the default text color used for EDIT widgets.

#### Prototype

```
GUI_COLOR EDIT_GetDefaultTextColor(unsigned int Index);
```

#### Parameters

Parameter	Description
<a href="#">Index</a>	Has to be 0, reserved for future use.

#### Return value

Default text color used for EDIT widgets.

### 7.2.8.5.1.19 EDIT\_GetFloatValue()

#### Description

Returns the current value of the EDIT widget as floating point value.

#### Prototype

```
float EDIT_GetFloatValue(EDIT_Handle hObj);
```

#### Parameters

Parameter	Description
<a href="#">hObj</a>	Handle of EDIT widget.

#### Return value

The current value.

#### Additional information

The use of this function makes only sense if the edit field is in floating point edit mode.

### 7.2.8.5.1.20 EDIT\_GetFont()

#### Description

Returns a pointer to the used font.

#### Prototype

```
GUI_FONT *EDIT_GetFont(EDIT_Handle hObj);
```

#### Parameters

Parameter	Description
<a href="#">hObj</a>	Handle of EDIT widget.

#### Return value

Pointer to the used font.

### 7.2.8.5.1.21 EDIT\_GetMinMax()

#### Description

This function is used to retrieve the minimum and maximum value set for the EDIT widget in decimal mode.

#### Prototype

```
void EDIT_GetMinMax(EDIT_Handle  hObj,  
                   int          * pMin,  
                   int          * pMax);
```

#### Parameters

Parameter	Description
<a href="#">hObj</a>	Handle of EDIT widget.
<a href="#">pMin</a>	Pointer to retrieve the minimum value.
<a href="#">pMax</a>	Pointer to retrieve the maximum value.

#### Additional information

This function works only for an EDIT widget used in decimal mode that has a minimum and a maximum value set. Otherwise [pMin](#) and [pMax](#) are getting set to 0.

### 7.2.8.5.1.22 EDIT\_GetNumChars()

#### Description

Returns the number of characters of the specified EDIT widget.

#### Prototype

```
int EDIT_GetNumChars(EDIT_Handle hObj);
```

#### Parameters

Parameter	Description
<a href="#">hObj</a>	Handle of EDIT widget.

#### Return value

Number of characters of the specified EDIT widget.

### 7.2.8.5.1.23 EDIT\_GetSel()

#### Description

Returns the current selection.

#### Prototype

```
void EDIT_GetSel(EDIT_Handle  hObj,  
                int          * pFirstChar,  
                int          * pLastChar);
```

#### Parameters

Parameter	Description
<code>hObj</code>	Handle of EDIT widget.
<code>pFirstChar</code>	Pointer to an int where the number of the first selected char will be stored in.
<code>pLastChar</code>	Pointer to an int where the number of the last selected char will be stored in.

### 7.2.8.5.1.24 EDIT\_GetSelText()

#### Description

Copies the selected text into a buffer.

#### Prototype

```
void EDIT_GetSelText(EDIT_Handle hObj,  
                    char * sDest,  
                    int MaxLen);
```

#### Parameters

Parameter	Description
<code>hObj</code>	Handle of EDIT widget.
<code>sDest</code>	Pointer to buffer.
<code>MaxLen</code>	Size of buffer.

### 7.2.8.5.1.25 EDIT\_GetText()

#### Description

Retrieves the user input of a specified EDIT widget.

#### Prototype

```
void EDIT_GetText(EDIT_Handle hObj,  
                 char * sDest,  
                 int MaxLen);
```

#### Parameters

Parameter	Description
<code>hObj</code>	Handle of EDIT widget.
<code>sDest</code>	Pointer to buffer.
<code>MaxLen</code>	Size of buffer.



### 7.2.8.5.1.26 EDIT\_GetTextAlign()

#### Description

This function returns the currently set alignment of the EDIT widget.

#### Prototype

```
int EDIT_GetTextAlign(EDIT_Handle hObj);
```

#### Parameters

Parameter	Description
<a href="#">hObj</a>	Handle of EDIT widget.

#### Return value

The currently set text alignment for the given EDIT widget.

### 7.2.8.5.1.27 EDIT\_GetTextColor()

#### Description

Returns the text color.

#### Prototype

```
GUI_COLOR EDIT_GetTextColor(EDIT_Handle hObj,  
                           unsigned int Index);
```

#### Parameters

Parameter	Description
<a href="#">hObj</a>	Handle of EDIT widget.
<a href="#">Index</a>	Color index. See <i>EDIT color indexes</i> on page 1392 for a full list of permitted values.

#### Return value

The currently set text color.

### 7.2.8.5.1.28 EDIT\_GetUserData()

#### Description

Prototype explained at the beginning of the chapter as `<WIDGET>_GetUserData()` on page 1165.

### 7.2.8.5.1.29 EDIT\_GetValue()

#### Description

Returns the current value of the EDIT widget. The current value is only useful if the EDIT widget is in binary, decimal or hexadecimal mode.

#### Prototype

```
I32 EDIT_GetValue(EDIT_Handle hObj);
```

#### Parameters

Parameter	Description
<a href="#">hObj</a>	Handle of EDIT widget.

#### Return value

The current value.

### 7.2.8.5.1.30 EDIT\_SetBinMode()

#### Description

Enables the binary edit mode of the EDIT widget. The given value can be modified in the given range.

#### Prototype

```
void EDIT_SetBinMode(EDIT_Handle hEdit,  
                    U32          Value,  
                    U32          Min,  
                    U32          Max);
```

#### Parameters

Parameter	Description
<a href="#">hObj</a>	Handle of EDIT widget.
<a href="#">Value</a>	<a href="#">Value</a> to be modified.
<a href="#">Min</a>	Minimum value.
<a href="#">Max</a>	Maximum value.

### 7.2.8.5.1.31 EDIT\_SetBkColor()

#### Description

Sets the background color of the EDIT widget.

#### Prototype

```
void EDIT_SetBkColor(EDIT_Handle hObj,  
                    unsigned int Index,  
                    GUI_COLOR Color);
```

#### Parameters

Parameter	Description
<a href="#">hObj</a>	Handle of EDIT widget.
<a href="#">Index</a>	<a href="#">Color</a> index. See <i>EDIT color indexes</i> on page 1392 for a full list of permitted values.
<a href="#">Color</a>	<a href="#">Color</a> to be set.

### 7.2.8.5.1.32 EDIT\_SetCursorAtChar()

#### Description

Sets the EDIT widget cursor to a specified character position.

#### Prototype

```
void EDIT_SetCursorAtChar(EDIT_Handle hObj,  
                          int         Pos);
```

#### Parameters

Parameter	Description
<code>hObj</code>	Handle of EDIT widget.
<code>Pos</code>	Character position to set cursor to.

#### Additional information

The character position works as follows:

- 0: left of the first (leftmost) character,
- 1: between the first and second characters,
- 2: between the second and third characters, and so on.

### 7.2.8.5.1.33 EDIT\_SetCursorAtPixel()

#### Description

Sets the EDIT widget cursor to a specified pixel position.

#### Prototype

```
void EDIT_SetCursorAtPixel(EDIT_Handle hObj,  
                           int         xPos);
```

#### Parameters

Parameter	Description
<code>hObj</code>	Handle of EDIT widget.
<code>xPos</code>	Pixel position to set cursor to.



### 7.2.8.5.1.34 EDIT\_SetDecMode()

#### Description

Enables the decimal edit mode of the EDIT widget. The given value can be modified in the given range.

#### Prototype

```
void EDIT_SetDecMode(EDIT_Handle hEdit,
                    I32          Value,
                    I32          Min,
                    I32          Max,
                    int          Shift,
                    U8           Flags);
```

#### Parameters

Parameter	Description
<code>hObj</code>	Handle of EDIT widget.
<code>Value</code>	<code>Value</code> to be set.
<code>Min</code>	Minimum value.
<code>Max</code>	Maximum value.
<code>Shift</code>	If > 0 it specifies the position of the decimal point.
<code>Flags</code>	See <i>EDIT flags</i> on page 1393 for a full list of permitted values.

### 7.2.8.5.1.35 EDIT\_SetDefaultBkColor()

#### Description

Sets the default background color used for EDIT widgets.

#### Prototype

```
void EDIT_SetDefaultBkColor(unsigned int Index,  
                             GUI_COLOR   Color);
```

#### Parameters

Parameter	Description
Index	Color index. See table below.
Color	Color to be used.

### 7.2.8.5.1.36 EDIT\_SetDefaultFont()

#### Description

Sets the default font used for EDIT widgets.

#### Prototype

```
void EDIT_SetDefaultFont(const GUI_FONT * pFont);
```

#### Parameters

Parameter	Description
<code>pFont</code>	Pointer to the font to be set as default.

### 7.2.8.5.1.37 EDIT\_SetDefaultTextAlign()

#### Description

Sets the default text alignment for EDIT widgets.

#### Prototype

```
void EDIT_SetDefaultTextAlign(int Align);
```

#### Parameters

Parameter	Description
<code>Align</code>	Default text alignment. For details, refer to <code>EDIT_SetTextAlign()</code> .

### 7.2.8.5.1.38 EDIT\_SetDefaultTextColor()

#### Description

Sets the default text color used for EDIT widgets.

#### Prototype

```
void EDIT_SetDefaultTextColor(unsigned int Index,  
                             GUI_COLOR  Color);
```

#### Parameters

Parameter	Description
<code>Index</code>	Has to be 0, reserved for future use.
<code>Color</code>	<code>Color</code> to be used.

### 7.2.8.5.1.39 EDIT\_SetFloatMode()

#### Description

Enables the floating point edit mode of the EDIT widget. The given value can be modified in the given range.

#### Prototype

```
void EDIT_SetFloatMode(EDIT_Handle hEdit,
                      float      Value,
                      float      Min,
                      float      Max,
                      int        Shift,
                      U8         Flags);
```

#### Parameters

Parameter	Description
<code>hObj</code>	Handle of EDIT widget.
<code>Value</code>	<code>Value</code> to be modified.
<code>Min</code>	Minimum value.
<code>Max</code>	Maximum value.
<code>Shift</code>	Number of post decimal positions.
<code>Flags</code>	See <i>EDIT flags</i> on page 1393 for a full list of permitted values.

#### Additional information

The float calculation of the EDIT widget is based on 32 bit signed integer calculation. If using 4 decimal places, the values have to be internally multiplied with  $10^4$ . That exceeds the range of  $2^{31}$ . Editing values with 9 digits (before and after decimal point) will work.

### 7.2.8.5.1.40 EDIT\_SetFloatValue()

#### Description

The function can be used to set the floating point value of the EDIT widget if working in floating point mode.

#### Prototype

```
void EDIT_SetFloatValue(EDIT_Handle hObj,  
                        float Value);
```

#### Parameters

Parameter	Description
<code>hObj</code>	Handle of EDIT widget.
<code>Value</code>	New floating point value of the EDIT widget.

#### Additional information

The use of this function makes only sense if the EDIT widget works in floating point mode. If working in text mode the function has no effect. If working in binary, decimal or hexadecimal mode the behavior of the EDIT widget is undefined.

### 7.2.8.5.1.41 EDIT\_SetFocusable()

#### Description

Sets the focusability of the EDIT widget.

#### Prototype

```
void EDIT_SetFocusable(EDIT_Handle hObj,  
                      int          State);
```

Parameter	Description
<code>hObj</code>	Handle of EDIT widget.
<code>State</code>	If State is set to 0, the EDIT widget is set not to be focusable. Otherwise it is set to be focusable.



### 7.2.8.5.1.42 EDIT\_SetFont()

#### Description

Sets the used font of the EDIT widget.

#### Prototype

```
void EDIT_SetFont(      EDIT_Handle  hObj,  
                    const GUI_FONT  * pFont);
```

#### Parameters

Parameter	Description
<code>hObj</code>	Handle of EDIT widget.
<code>pFont</code>	Pointer to the font.

### 7.2.8.5.1.43 EDIT\_SetHexMode()

#### Description

Enables the hexadecimal edit mode of the EDIT widget. The given value can be modified in the given range.

#### Prototype

```
void EDIT_SetHexMode(EDIT_Handle hEdit,  
                    U32          Value,  
                    U32          Min,  
                    U32          Max);
```

#### Parameters

Parameter	Description
<a href="#">hObj</a>	Handle of EDIT widget.
<a href="#">Value</a>	<a href="#">Value</a> to be modified.
<a href="#">Min</a>	Minimum value.
<a href="#">Max</a>	Maximum value.

#### 7.2.8.5.1.44 EDIT\_SetInsertMode()

##### Description

Enables or disables the insert mode of the EDIT widget.

##### Prototype

```
int EDIT_SetInsertMode(EDIT_Handle hObj,  
                      int          OnOff);
```

##### Parameters

Parameter	Description
<code>hObj</code>	Handle of EDIT widget.
<code>OnOff</code>	0 for disabling insert mode, 1 for enabling insert mode.

##### Return value

Returns the previous insert mode state.

##### Additional information

The use of this function makes only sense if the EDIT widget operates in text mode or in any user defined mode. If working in hexadecimal, binary, floating point or decimal mode the use of this function has no effect except that it changes the appearance of the cursor.

### 7.2.8.5.1.45 EDIT\_SetMaxLen()

#### Description

Sets the maximum number of characters to be edited by the given EDIT widget.

#### Prototype

```
void EDIT_SetMaxLen(EDIT_Handle hObj,  
                   int         MaxLen);
```

#### Parameters

Parameter	Description
<a href="#">hObj</a>	Handle of EDIT widget.
<a href="#">MaxLen</a>	Number of characters.

### 7.2.8.5.1.46 EDIT\_SetPasswordChar()

#### Description

Sets the global password character used for EDITs in password mode.

#### Prototype

```
U16 EDIT_SetPasswordChar(U16 PasswordChar);
```

#### Parameters

Parameter	Description
<a href="#">PasswordChar</a>	New character to be used.

#### Return value

Old password character.

### 7.2.8.5.1.47 EDIT\_SetPasswordMode()

#### Description

Enables password mode for the given EDIT widget.

#### Prototype

```
void EDIT_SetPasswordMode(EDIT_Handle hObj,  
                           int         OnOff);
```

#### Parameters

Parameter	Description
<code>hObj</code>	Handle of EDIT widget.
<code>OnOff</code>	1 for enabling password mode, 0 for disabling.

### 7.2.8.5.1.48 EDIT\_SetpfAddKeyEx()

#### Description

Sets the function pointer which is used by the EDIT widget to call the function which is responsible for adding characters.

#### Prototype

```
void EDIT_SetpfAddKeyEx(EDIT_Handle    hObj,  
                       tEDIT_AddKeyEx * pfAddKeyEx);
```

#### Parameters

Parameter	Description
<a href="#">hObj</a>	Handle of EDIT widget.
<a href="#">pfAddKeyEx</a>	Function pointer to the function to be used to add a character.

#### Additional information

If working in text mode (default) or one of the modes for editing values, the EDIT widget uses its own routines to add a character. The use of this function only makes sense if the default behavior of the EDIT widget needs to be changed. If [pfAddKeyEx](#) returns 0 the default key handling of the EDIT will still happen. If [pfAddKeyEx](#) returns 1 the EDIT will not execute the default handling.

### 7.2.8.5.1.49 EDIT\_SetSel()

Before	After
	

#### Description

Used to set the current selection of the EDIT widget.

#### Prototype

```
void EDIT_SetSel(EDIT_Handle hObj,
                int          FirstChar,
                int          LastChar);
```

#### Parameters

Parameter	Description
<code>hObj</code>	Handle of EDIT widget.
<code>FirstChar</code>	Zero based index of the first character to be selected. -1 if no character should be selected.
<code>LastChar</code>	Zero based index of the last character to be selected. -1 if all characters from the first character until the last character should be selected.

#### Additional information

Selected characters are usually displayed in reverse. Setting the cursor position deselects all characters.

#### Example

```
EDIT_SetSel(hEdit, 0, -1); // Selects all characters of the widget
EDIT_SetSel(hEdit, -1, 0); // Deselects all characters
EDIT_SetSel(hEdit, 0, 2); // Selects the first 3 characters
```



### 7.2.8.5.1.50 EDIT\_SetText()

#### Description

Sets the text to be displayed in the EDIT widget.

#### Prototype

```
void EDIT_SetText(      EDIT_Handle  hObj,  
                    const char    * s);
```

#### Parameters

Parameter	Description
<code>hObj</code>	Handle of EDIT widget.
<code>s</code>	Text to display.

### 7.2.8.5.1.51 EDIT\_SetTextAlign()

#### Description

Sets the text alignment of the EDIT widget.

#### Prototype

```
void EDIT_SetTextAlign(EDIT_Handle hObj,  
                      int          Align);
```

#### Parameters

Parameter	Description
<code>hObj</code>	Handle of EDIT widget.
<code>Align</code>	Or-combination of text alignment flags. List of flags can be found under <i>Text alignment flags</i> on page 286.

### 7.2.8.5.1.52 EDIT\_SetTextColor()

#### Description

Sets the text color of the EDIT widget.

#### Prototype

```
void EDIT_SetTextColor(EDIT_Handle hObj,  
                      unsigned int Index,  
                      GUI_COLOR   Color);
```

#### Parameters

Parameter	Description
<a href="#">hObj</a>	Handle of EDIT widget.
<a href="#">Index</a>	<a href="#">Index</a> for text color. See <i>EDIT color indexes</i> on page 1392 for a full list of permitted values.
<a href="#">Color</a>	<a href="#">Color</a> to be set.

### 7.2.8.5.1.53 EDIT\_SetTextMode()

#### Description

Sets the edit mode of the EDIT widget back to text mode.

#### Prototype

```
void EDIT_SetTextMode(EDIT_Handle hEdit);
```

#### Parameters

Parameter	Description
<a href="#">hObj</a>	Handle of EDIT widget.

#### Additional information

If one of the functions `EDIT_SetBinMode()`, `EDIT_SetDecMode()`, `EDIT_SetFloatMode()` or `EDIT_SetHexMode()` has been used to set the EDIT widget to one of the numeric edit modes, this function sets the edit mode back to text mode. It also clears the content of the EDIT widget.

### 7.2.8.5.1.54 EDIT\_SetValue()

#### Description

Sets the current value of the EDIT widget. Only useful if binary, decimal or hexadecimal edit mode is set.

#### Prototype

```
void EDIT_SetValue(EDIT_Handle hObj,  
                  I32          Value);
```

#### Parameters

Parameter	Description
<a href="#">hObj</a>	Handle of EDIT widget.
<a href="#">Value</a>	New value.

### 7.2.8.5.1.55 EDIT\_SetUlongMode()

#### Description

Enables the unsigned long decimal edit mode of the EDIT widget. The given value can be modified in the given range.

#### Prototype

```
void EDIT_SetUlongMode(EDIT_Handle hEdit,  
                       U32         Value,  
                       U32         Min,  
                       U32         Max);
```

#### Parameters

Parameter	Description
<a href="#">hObj</a>	Handle of EDIT widget.
<a href="#">Value</a>	<a href="#">Value</a> to be modified.
<a href="#">Min</a>	Minimum value.
<a href="#">Max</a>	Maximum value.

### 7.2.8.5.1.56 EDIT\_SetUserData()

#### Description

Prototype explained at the beginning of the chapter as `<WIDGET>_SetUserData()` on page 1166.

## 7.2.8.5.2 Defines

### 7.2.8.5.2.1 EDIT color indexes

#### Description

Color indexes for EDIT widget.

#### Definition

```
#define EDIT_CI_DISABLED    0
#define EDIT_CI_ENABLED    1
#define EDIT_CI_CURSOR     2
```

#### Symbols

Definition	Description
<code>EDIT_CI_DISABLED</code>	Color index for the disabled state.
<code>EDIT_CI_ENABLED</code>	Color index for the enabled state.
<code>EDIT_CI_CURSOR</code>	Color to be used for the cursor. This is only taken into account if the cursor is not in inversion mode ( <code>EDIT_EnableInversion(0)</code> ).



### 7.2.8.5.2 EDIT flags

#### Description

These flags are used if the EDIT widget is in decimal or float mode. This can be activated by calling `EDIT_SetDecMode()` or `EDIT_SetFloatMode()`. These flags are OR-combinable.

#### Definition

```
#define GUI_EDIT_NORMAL          (0 << 0)
#define GUI_EDIT_SIGNED        (1 << 0)
#define GUI_EDIT_SUPPRESS_LEADING_ZEROES (1 << 1)
```

#### Symbols

Definition	Description
<code>GUI_EDIT_NORMAL</code>	Edit in normal mode. A sign is displayed only if the value is negative.
<code>GUI_EDIT_SIGNED</code>	"+" and "-" sign is displayed.
<code>GUI_EDIT_SUPPRESS_LEADING_ZEROES</code>	Does not show leading zeroes.

## 7.2.8.6 Examples

The `Sample` folder contains the following examples which show how the widget can be used:

- `WIDGET_Edit.c`
- `WIDGET_EditWinmode.c`

Note that several other examples also make use of this widget and may also be helpful to get familiar with the widget.

### Screenshot of `WIDGET_Edit.c`:



### Screenshot of `WIDGET_EditWinmode.c`:



## 7.2.9 FRAMEWIN: Frame window widget



FRAMEWIN widgets give your application a PC application-window appearance. They consist of a surrounding frame, a title bar and a user area. The color of the title bar changes to show whether the window is active or inactive, as seen below:

Active frame window	Inactive frame window
	

**Note**

All FRAMEWIN-related routines are located in the file(s) FRAMEWIN\*.c, FRAMEWIN.h. All identifiers are prefixed FRAMEWIN.

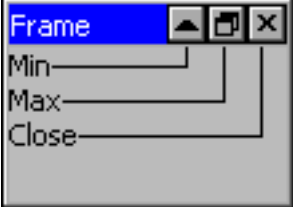
You can attach predefined buttons to the title bar as seen below or you can attach your own buttons to a title bar:

Description	Frame window
Frame window with minimize-, maximize- and close button.	
Frame window with minimize-, maximize- and close button in maximized state.	
Frame window with minimize-, maximize- and close button in minimized state	

**Skinning...**

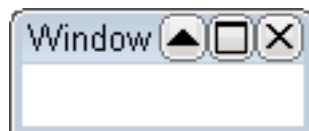

...is available for this widget. The screenshot above shows the widget using the default skin. Details can be found in the chapter *Skinning* on page 2800.

**Note**

This widget uses skinning. To change the look it is recommended to use the function <WIDGET>\_SetSkinFlexProps(). Other functions to change the look might work only with the classic skin.

### 7.2.9.1 Structure of the frame window

The following diagram shows the detailed structure and looks of a frame window:

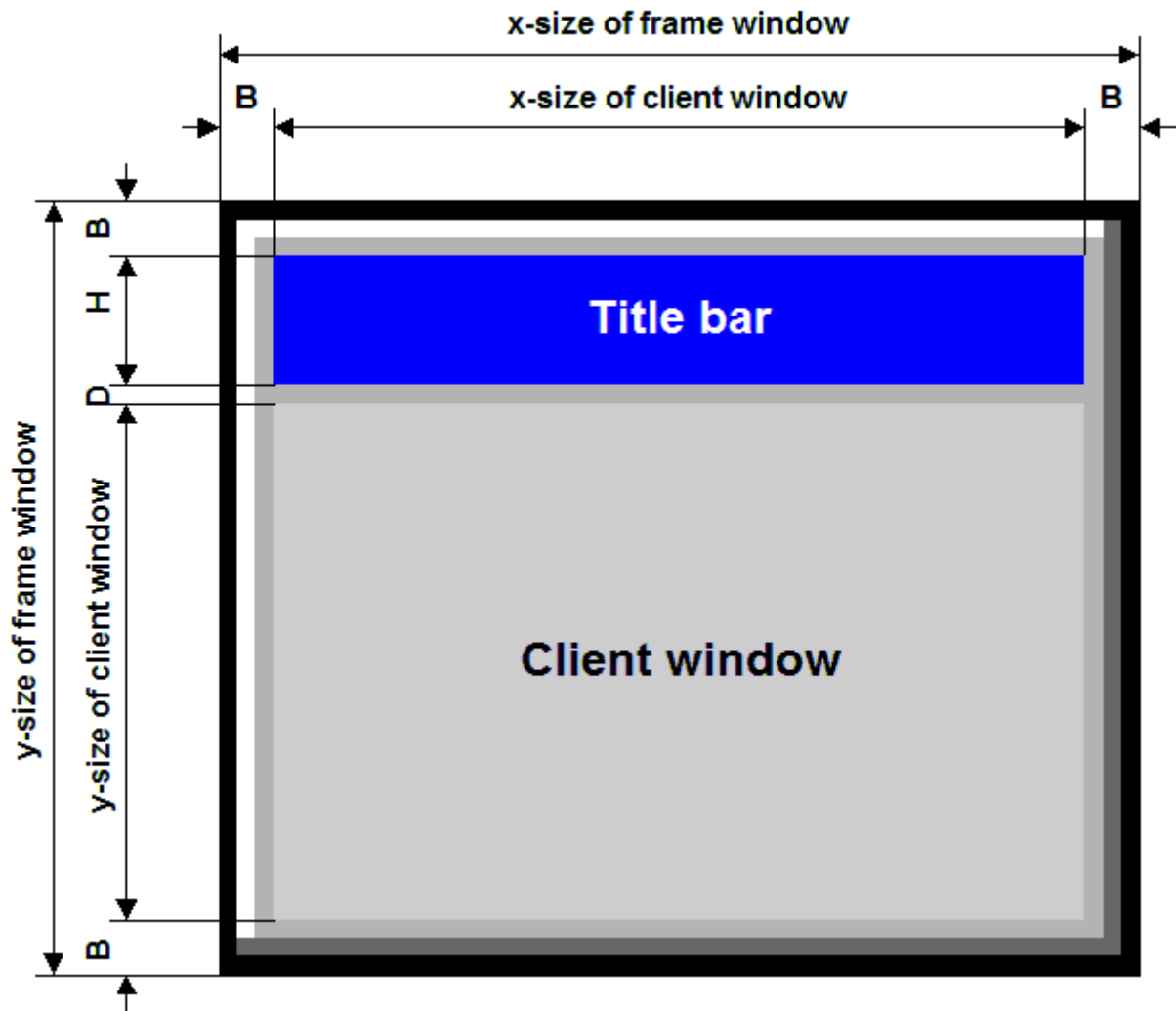

The frame window actually consists of 2 windows; the main window and a child window. The child window is called `Client window`. It is important to be aware of this when dealing with callback functions: There are 2 windows with 2 different callback functions. When creating child windows, these child windows are typically created as children of the client window; their parent is therefor the client window.

Detail	Description
<code>B</code>	Border size of the frame window. The default size of the border is 3 pixels.
<code>H</code>	Height of the title bar. Depends on the size of the used font for the title.
<code>D</code>	Spacing between title bar and client window. (1 pixel)
<code>Title bar</code>	The title bar is part of the frame window and not a separate window.
<code>Client window</code>	The client window is a separate window created as a child window of the frame window.

## 7.2.9.2 Configuration options

Type	Macro	Default	Description
B	FRAMEWIN_ALLOW_DRAG_ON_FRAME	1	Allows dragging the widget on the surrounding frame.
N	FRAMEWIN_BARCOLOR_ACTIVE_DEFAULT	0xff0000	Title bar background color, active state.
N	FRAMEWIN_BARCOLOR_INACTIVE_DEFAULT	0x404040	Title bar background color, inactive state.
N	FRAMEWIN_BORDER_DEFAULT	3	Outer border width, in pixels.
N	FRAMEWIN_CLIENTCOLOR_DEFAULT (with WIDGET_USE_FLEX_SKIN = 0) (with WIDGET_USE_FLEX_SKIN = 1)	0xc0c0c0 GUI_WHITE	Color of client window area.
S	FRAMEWIN_DEFAULT_FONT (with WIDGET_USE_FLEX_SKIN = 0) (with WIDGET_USE_FLEX_SKIN = 1)	&GUI_Font8_1 &GUI_Font13_1	Font used for title bar text.
N	FRAMEWIN_FRAMECOLOR_DEFAULT	0xaaaaaa	Frame color.
N	FRAMEWIN_IBORDER_DEFAULT	1	Inner border width, in pixels.
N	FRAMEWIN_TEXTCOLOR_ACTIVE_DEFAULT (with WIDGET_USE_FLEX_SKIN = 0) (with WIDGET_USE_FLEX_SKIN = 1)	GUI_WHITE GUI_BLACK	Title bar text color, active state.
N	FRAMEWIN_TEXTCOLOR_INACTIVE_DEFAULT (with WIDGET_USE_FLEX_SKIN = 0) (with WIDGET_USE_FLEX_SKIN = 1)	GUI_WHITE GUI_BLACK	Title bar text color, inactive state.
N	FRAMEWIN_TITLEHEIGHT_DEFAULT	0	Default height of title bar.

## 7.2.9.3 Keyboard reaction

The widget can not gain the input focus and does not react on keyboard input.

## 7.2.9.4 FRAMEWIN API

The table below lists the available emWin FRAMEWIN-related routines in alphabetical order. Detailed descriptions of the routines follow.

### Functions

Routine	Description
<a href="#">FRAMEWIN_AddButton()</a>	Adds a button to the title bar of the FRAMEWIN widget.
<a href="#">FRAMEWIN_AddCloseButton()</a>	Adds a close button to the title bar of the FRAMEWIN widget.
<a href="#">FRAMEWIN_AddMaxButton()</a>	Adds a maximize button to the title bar of the FRAMEWIN widget.
<a href="#">FRAMEWIN_AddMenu()</a>	Adds the given menu to a FRAMEWIN widget.
<a href="#">FRAMEWIN_AddMinButton()</a>	Adds a minimize button to the title bar of the FRAMEWIN widget.
<a href="#">FRAMEWIN_Create()</a>	Creates a FRAMEWIN widget. (Obsolete)
<a href="#">FRAMEWIN_CreateAsChild()</a>	Creates a FRAMEWIN widget as a child window. (Obsolete)

Routine	Description
<code>FRAMEWIN_CreateEx()</code>	Creates a FRAMEWIN widget.
<code>FRAMEWIN_CreateIndirect()</code>	Creates a FRAMEWIN widget from a resource table entry.
<code>FRAMEWIN_CreateUser()</code>	Creates a FRAMEWIN widget using extra bytes as user data.
<code>FRAMEWIN_GetActive()</code>	Returns if the given FRAMEWIN widget is in active state or not.
<code>FRAMEWIN_GetBarColor()</code>	Returns the color of the title bar of the given FRAMEWIN widget.
<code>FRAMEWIN_GetBorderSize()</code>	Returns the border size of the given FRAMEWIN widget.
<code>FRAMEWIN_GetDefaultBarColor()</code>	Returns the default color for title bars in FRAMEWIN widgets.
<code>FRAMEWIN_GetDefaultBorderSize()</code>	Returns the default border size of FRAMEWIN widgets.
<code>FRAMEWIN_GetDefaultClientColor()</code>	Returns the default color of client areas in FRAMEWIN widgets.
<code>FRAMEWIN_GetDefaultFont()</code>	Returns the default font used for captions of FRAMEWIN widgets.
<code>FRAMEWIN_GetDefaultTextColor()</code>	Returns the default text color of the title.
<code>FRAMEWIN_GetDefaultTitleHeight()</code>	Returns the default height of title bars in FRAMEWIN widget.
<code>FRAMEWIN_GetFont()</code>	Returns a pointer to the font used to draw the title text.
<code>FRAMEWIN_GetText()</code>	Returns the title text.
<code>FRAMEWIN_GetTextAlign()</code>	Returns the text alignment of the title text.
<code>FRAMEWIN_GetTitleHeight()</code>	Returns the height of title bar of the given FRAMEWIN widget.
<code>FRAMEWIN_GetUserData()</code>	Retrieves the data set with <code>FRAMEWIN_SetUserData()</code> .
<code>FRAMEWIN_IsMinimized()</code>	Returns if the FRAMEWIN widget is minimized or not.
<code>FRAMEWIN_IsMaximized()</code>	Returns if the FRAMEWIN widget is maximized or not.
<code>FRAMEWIN_Maximize()</code>	Enlarges a FRAMEWIN widget to the size of its parent window.
<code>FRAMEWIN_Minimize()</code>	Hides the client area of the given FRAMEWIN widget.
<code>FRAMEWIN_OwnerDraw()</code>	Default function for drawing the title bar of a FRAMEWIN widget.
<code>FRAMEWIN_Restore()</code>	Restores a minimized or maximized FRAMEWIN widget to its old size and position.
<code>FRAMEWIN_SetActive()</code>	Sets the state of a specified FRAMEWIN widget.
<code>FRAMEWIN_SetBarColor()</code>	Sets the color of the title bar of a specified FRAMEWIN widget.
<code>FRAMEWIN_SetBorderSize()</code>	Sets the border size of a specified FRAMEWIN widget.

Routine	Description
<code>FRAMEWIN_SetClientColor()</code>	Sets the color of the client window area of a specified FRAMEWIN widget.
<code>FRAMEWIN_SetDefaultBarColor()</code>	Sets the default color for title bars in FRAMEWIN widgets.
<code>FRAMEWIN_SetDefaultBorderSize()</code>	Sets the default border size of FRAMEWIN widgets.
<code>FRAMEWIN_SetDefaultClientColor()</code>	Sets the default color for client areas in FRAMEWIN widgets.
<code>FRAMEWIN_SetDefaultFont()</code>	Sets the default font used to display the title in FRAMEWIN widgets.
<code>FRAMEWIN_SetDefaultTextColor()</code>	Sets the default text color of the title.
<code>FRAMEWIN_SetDefaultTitleHeight()</code>	Sets the size in Y for the title bar.
<code>FRAMEWIN_SetFont()</code>	Sets the title font of the FRAMEWIN widget.
<code>FRAMEWIN_SetMoveable()</code>	Sets a FRAMEWIN widget to a moveable or fixed state.
<code>FRAMEWIN_SetOwnerDraw()</code>	Enables the FRAMEWIN widget to be owner drawn.
<code>FRAMEWIN_SetResizable()</code>	Sets the resizable state of the given FRAMEWIN widget.
<code>FRAMEWIN_SetText()</code>	Sets the title text.
<code>FRAMEWIN_SetTextAlign()</code>	Sets the text alignment of the title bar.
<code>FRAMEWIN_SetTextColor()</code>	Sets the color of the title text for both states, active and inactive.
<code>FRAMEWIN_SetTextColorEx()</code>	Sets the text color for the given state.
<code>FRAMEWIN_SetTitleHeight()</code>	Sets the height of the title bar.
<code>FRAMEWIN_SetTitleVis()</code>	Sets the visibility flag of the title bar.
<code>FRAMEWIN_SetUserData()</code>	Sets the extra data of a FRAMEWIN widget.

## Defines

Group of defines	Description
<code>FRAMEWIN</code> button flags	Determine on which side of the FRAMEWIN a button should be added.
<code>FRAMEWIN</code> create flags	Create flags that define the behavior of the FRAMEWIN widget.
<code>FRAMEWIN</code> states	State of the FRAMEWIN used for various functions.

## 7.2.9.4.1 Functions

### 7.2.9.4.1.1 FRAMEWIN\_AddButton()

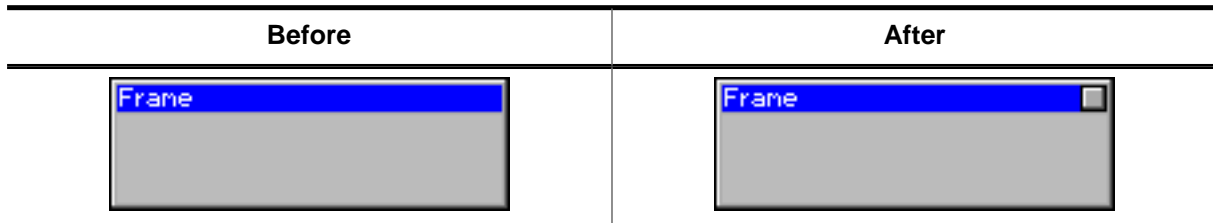

#### Description

Adds a button to the title bar of the FRAMEWIN widget.

#### Prototype

```
WM_HWIN FRAMEWIN_AddButton(FRAMEWIN_Handle hObj,
                             int           Flags,
                             int           Off,
                             int           Id);
```

#### Parameters

Parameter	Description
<code>hObj</code>	Handle of FRAMEWIN widget.
<code>Flags</code>	See <i>FRAMEWIN button flags</i> on page 1452 for a full list of permitted values.
<code>Off</code>	X-offset used to create the BUTTON widget
<code>Id</code>	ID of the BUTTON widget

#### Return value

Handle of the BUTTON widget.

#### Additional information

The button will be created as a child window from the FRAMEWIN widget. So the Window Manager keeps sure it will be deleted when the FRAMEWIN widget will be deleted.

The button can be created at the left side or at the right side of the title bar depending on the parameter `Flags`. The parameter `Offset` specifies the space between the button and the border of the FRAMEWIN widget or the space between the previous created button.



### 7.2.9.4.1.2 FRAMEWIN\_AddCloseButton()

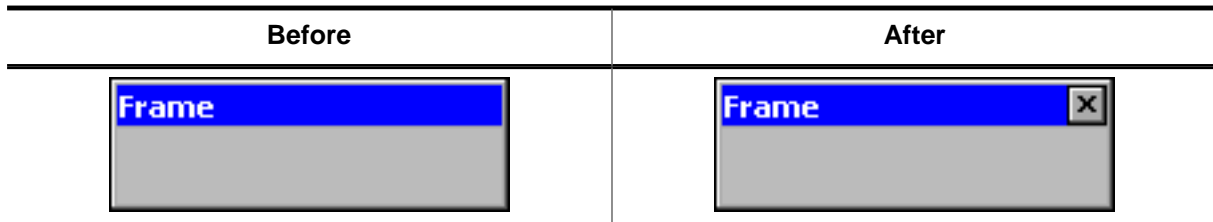

#### Description

Adds a close button to the title bar of the FRAMEWIN widget.

#### Prototype

```
WM_HWIN FRAMEWIN_AddCloseButton(FRAMEWIN_Handle hObj,
                                  int             Flags,
                                  int             Off);
```

#### Parameters

Parameter	Description
<code>hObj</code>	Handle of FRAMEWIN widget.
<code>Flags</code>	See <i>FRAMEWIN button flags</i> on page 1452 for a full list of permitted values.
<code>Off</code>	X-offset used to create the BUTTON widget

#### Return value

Handle of the close button.

#### Additional information

When the user presses the close button the frame window and all its children will be deleted.

### 7.2.9.4.1.3 FRAMEWIN\_AddMaxButton()

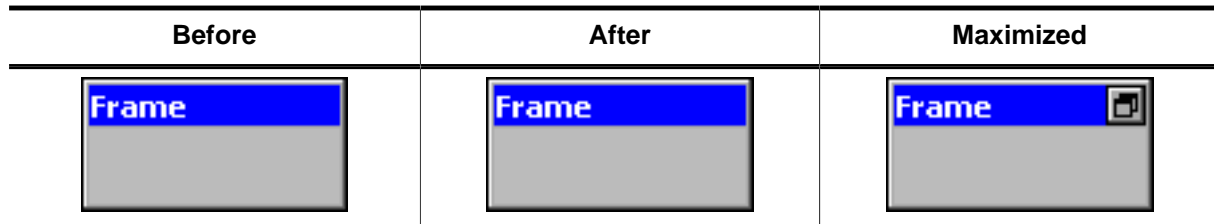

#### Description

Adds a maximize button to the title bar of the FRAMEWIN widget.

#### Prototype

```
WM_HWIN FRAMEWIN_AddMaxButton(FRAMEWIN_Handle hObj,
                               int               Flags,
                               int               Off);
```

#### Parameters

Parameter	Description
<code>hObj</code>	Handle of FRAMEWIN widget.
<code>Flags</code>	See <i>FRAMEWIN button flags</i> on page 1452 for a full list of permitted values.
<code>Off</code>	X-offset used to create the BUTTON widget

#### Return value

Handle of the maximize button.

#### Additional information

When the user presses the maximize button the first time the FRAMEWIN widget will be enlarged to the size of its parent window. The second use of the button will reduce the frame window to its old size and restores the old position.

### 7.2.9.4.1.4 FRAMEWIN\_AddMenu()

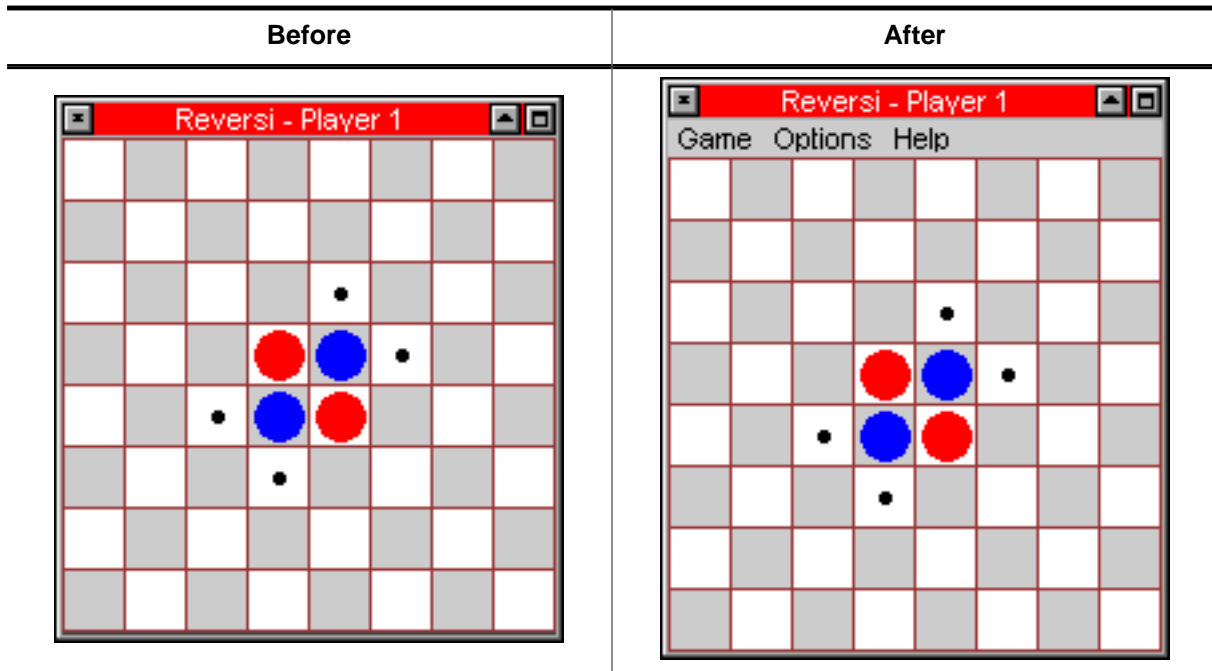

#### Description

Adds the given menu to a FRAMEWIN widget. The menu is shown below the title bar.

#### Prototype

```
void FRAMEWIN_AddMenu(FRAMEWIN_Handle hObj,
                     WM_HWIN         hMenu);
```

#### Parameters

Parameter	Description
<a href="#">hObj</a>	Handle of frame window.
<a href="#">hMenu</a>	Handle of MENU widget to be added.

#### Return value

Handle of the maximize button.

#### Additional information

The added MENU is attached as a child of the FRAMEWIN widget. If the FRAMEWIN widget has been created with a callback routine, the function makes sure, that the WM\_MENU messages are passed to the client window of the FRAMEWIN widget.

### 7.2.9.4.1.5 FRAMEWIN\_AddMinButton()

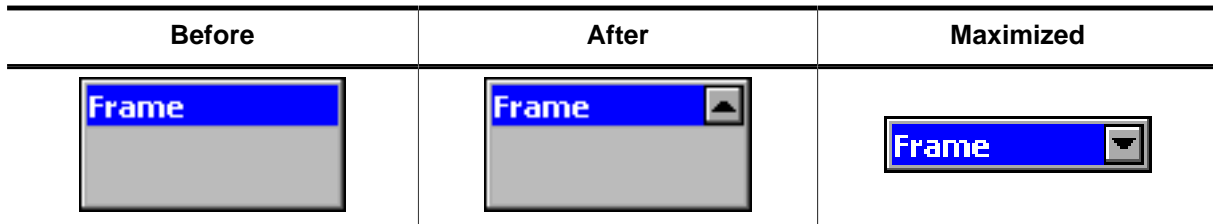

#### Description

Adds a minimize button to the title bar of the FRAMEWIN widget.

#### Prototype

```
WM_HWIN FRAMEWIN_AddMinButton(FRAMEWIN_Handle hObj,
                               int             Flags,
                               int             Off);
```

#### Parameters

Parameter	Description
<code>hObj</code>	Handle of FRAMEWIN widget.
<code>Flags</code>	See <i>FRAMEWIN button flags</i> on page 1452 for a full list of permitted values.
<code>Off</code>	X-offset used to create the BUTTON widget

#### Return value

Handle of the minimize button.

#### Additional information

When the user presses the minimize button the first time the client area of the FRAMEWIN widget will be hidden and only the title bar remains visible. The second use of the button will restore the FRAMEWIN widget to its old size.

### 7.2.9.4.1.6 FRAMEWIN\_Create()

#### Note

This function is **deprecated**, `FRAMEWIN_CreateEx()` should be used instead.

#### Description

Creates a FRAMEWIN widget of a specified size at a specified location.

#### Prototype

```
FRAMEWIN_Handle FRAMEWIN_Create(const char * pText,
                                WM_CALLBACK * cb,
                                int      Flags,
                                int      x0,
                                int      y0,
                                int      xSize,
                                int      ySize);
```

#### Parameters

Parameter	Description
<code>pTitle</code>	Title displayed in the title bar.
<code>cb</code>	Pointer to callback routine of client area.
<code>Flags</code>	Window create flags. Typically <code>WM_CF_SHOW</code> in order to make the widget visible immediately (refer to <i>Window create flags</i> on page 1146 for a list of available parameter values).
<code>x0</code>	Leftmost pixel of the frame window (in parent coordinates).
<code>y0</code>	Topmost pixel of the frame window (in parent coordinates).
<code>xSize</code>	Horizontal size of the frame window (in pixels).
<code>ySize</code>	Vertical size of the frame window (in pixels).

#### Return value

Handle of the created FRAMEWIN widget; 0 if the function fails.

### 7.2.9.4.1.7 FRAMEWIN\_CreateAsChild()

#### Note

This function is **deprecated**, `FRAMEWIN_CreateEx()` should be used instead.

#### Description

Creates a FRAMEWIN widget as a child window.

#### Prototype

```
FRAMEWIN_Handle FRAMEWIN_CreateAsChild(    int           x0,
                                           int           y0,
                                           int           xSize,
                                           int           ySize,
                                           WM_HWIN      hParent,
                                           const char    * pText,
                                           WM_CALLBACK * cb,
                                           int           Flags);
```

#### Parameters

Parameter	Description
<code>x0</code>	X-position of the FRAMEWIN widget relative to the parent window.
<code>y0</code>	Y-position of the FRAMEWIN widget relative to the parent window.
<code>xSize</code>	Horizontal size of the FRAMEWIN widget (in pixels).
<code>ySize</code>	Vertical size of the FRAMEWIN widget (in pixels).
<code>hParent</code>	Handle of parent window.
<code>pText</code>	Text to be displayed in the title bar.
<code>cb</code>	Optional pointer to a custom callback function for the client window.
<code>Flags</code>	Window create flags (see <i>Window create flags</i> on page 1146).

#### Return value

Handle of the created FRAMEWIN widget; 0 if the function fails.

### 7.2.9.4.1.8 FRAMEWIN\_CreateEx()

#### Description

Creates a FRAMEWIN widget of a specified size at a specified location.

#### Prototype

```
FRAMEWIN_Handle FRAMEWIN_CreateEx(    int        x0,
                                       int        y0,
                                       int        xSize,
                                       int        ySize,
                                       WM_HWIN    hParent,
                                       int        WinFlags,
                                       int        ExFlags,
                                       int        Id,
                                       const char * pTitle,
                                       WM_CALLBACK * cb);
```

#### Parameters

Parameter	Description
<code>x0</code>	Leftmost pixel of the FRAMEWIN widget (in parent coordinates).
<code>y0</code>	Topmost pixel of the FRAMEWIN widget (in parent coordinates).
<code>xSize</code>	Horizontal size of the FRAMEWIN widget (in pixels).
<code>ySize</code>	Vertical size of the FRAMEWIN widget (in pixels).
<code>hParent</code>	Handle of parent window. If 0, the new FRAMEWIN widget will be a child of the desktop (top-level window).
<code>WinFlags</code>	Window create flags. Typically <code>WM_CF_SHOW</code> in order to make the widget visible immediately (refer to <i>Window create flags</i> on page 1146 for a list of available parameter values).
<code>ExFlags</code>	See <i>FRAMEWIN create flags</i> on page 1453.
<code>Id</code>	Window ID of the FRAMEWIN widget.
<code>pTitle</code>	Title displayed in the title bar.
<code>cb</code>	Optional pointer to a custom callback function for the client window.

#### Return value

Handle of the created FRAMEWIN widget; 0 if the function fails.

#### Additional information

The user callback routine is typically used for 2 purposes:

- to paint the client window (if filling with a color is not desired)
- to react to messages of child windows, typically dialog elements The normal behaviour of the client window is to paint itself, filling the entire window with the client color. If the user callback also fills the client window (or a part of it), it can be desirable to set the client color to `GUI_INVALID_COLOR`, causing the window callback not to fill the client window.

The user callback of the client window does not receive all messages sent to the client window; some system messages are completely handled by the window callback routine and are not passed to the user callback. All notification messages as well as `WM_PAINT` and all user messages are sent to the user callback routine. The handle received by the user callback is the handle of the frame window (the parent window of the client window), except for the `WM_PAINT` message, which receives the handle of the client window.

### 7.2.9.4.1.9 FRAMEWIN\_CreateIndirect()

#### Description

The prototype of this function is explained at the beginning of this chapter. Details can be found in the description of the function `<WIDGET>_CreateIndirect()` on page 1161. The element `Para` of the according `GUI_WIDGET_CREATE_INFO` structure is not used. The element `Flags` is used according to the parameter `ExFlags` of the function `FRAMEWIN_CreateEx()`.



#### 7.2.9.4.1.10 FRAMEWIN\_CreateUser()

##### Description

Prototype explained at the beginning of the chapter as `<WIDGET>_CreateUser()` on page 1162. For a detailed description of the parameters the function `FRAMEWIN_CreateEx()` can be referred to.

### 7.2.9.4.1.11 FRAMEWIN\_GetActive()

#### Description

Returns if the given FRAMEWIN widget is in active state or not.

#### Prototype

```
int FRAMEWIN_GetActive(FRAMEWIN_Handle hObj);
```

#### Parameters

Parameter	Description
<a href="#">hObj</a>	Handle of FRAMEWIN widget.

#### Return value

1 if FRAMEWIN widget is in active state  
0 if not.

### 7.2.9.4.1.12 FRAMEWIN\_GetBarColor()

#### Description

Returns the color of the title bar of the given FRAMEWIN widget.

#### Prototype

```
GUI_COLOR FRAMEWIN_GetBarColor(FRAMEWIN_Handle hObj,  
                                unsigned Index);
```

#### Parameters

Parameter	Description
<a href="#">hObj</a>	Handle of FRAMEWIN widget.
<a href="#">Index</a>	See <i>FRAMEWIN states</i> on page 1454 for a full list of permitted values.

#### Return value

Color of the title bar as RGB value.

### 7.2.9.4.1.13 FRAMEWIN\_GetBorderSize()

#### Description

Returns the border size of the given FRAMEWIN widget.

#### Prototype

```
int FRAMEWIN_GetBorderSize(FRAMEWIN_Handle hObj);
```

#### Parameters

Parameter	Description
<a href="#">hObj</a>	Handle of FRAMEWIN widget.

#### Return value

The border size of the given FRAMEWIN widget.

#### 7.2.9.4.1.14 FRAMEWIN\_GetDefaultBarColor()

##### Description

Returns the default color for title bars in FRAMEWIN widgets.

##### Prototype

```
GUI_COLOR FRAMEWIN_GetDefaultBarColor(unsigned Index);
```

##### Parameters

Parameter	Description
<a href="#">Index</a>	See <i>FRAMEWIN states</i> on page 1454 for a full list of permitted values.

##### Return value

Pointer to the default title bar color used for FRAMEWIN widgets in the specified state.

#### 7.2.9.4.1.15 FRAMEWIN\_GetDefaultBorderSize()

##### Description

Returns the default border size of FRAMEWIN widgets.

##### Prototype

```
int FRAMEWIN_GetDefaultBorderSize(void);
```

##### Return value

Default border size of FRAMEWIN widgets.

#### 7.2.9.4.1.16 FRAMEWIN\_GetDefaultClientColor()

##### Description

Returns the default color of client areas in FRAMEWIN widgets.

##### Prototype

```
GUI_COLOR FRAMEWIN_GetDefaultClientColor(void);
```

##### Return value

Pointer to the default client area color.

#### 7.2.9.4.1.17 FRAMEWIN\_GetDefaultFont()

##### Description

Returns the default font used for captions of FRAMEWIN widgets.

##### Prototype

```
GUI_FONT *FRAMEWIN_GetDefaultFont(void);
```

##### Return value

Pointer to the default font used for captions of captions widgets.



### 7.2.9.4.1.18 FRAMEWIN\_GetDefaultTextColor()

#### Description

Returns the default text color of the title.

#### Prototype

```
GUI_COLOR FRAMEWIN_GetDefaultTextColor(unsigned Index);
```

#### Parameters

Parameter	Description
<a href="#">Index</a>	See <i>FRAMEWIN states</i> on page 1454 for a full list of permitted values.

#### Return value

Default text color of the title.

### 7.2.9.4.1.19 FRAMEWIN\_GetDefaultTitleHeight()

#### Description

Returns the default height of title bars in FRAMEWIN widget.

#### Prototype

```
int FRAMEWIN_GetDefaultTitleHeight(void);
```

#### Return value

Default title bar height. For more information about the title height, refer to `FRAMEWIN_SetDefaultTitleHeight()`.

### 7.2.9.4.1.20 FRAMEWIN\_GetFont()

#### Description

Returns a pointer to the font used to draw the title text.

#### Prototype

```
GUI_FONT *FRAMEWIN_GetFont(FRAMEWIN_Handle hObj);
```

#### Parameters

Parameter	Description
<a href="#">hObj</a>	Handle of FRAMEWIN widget.

#### Return value

Pointer to the font used to draw the title text.

### 7.2.9.4.1.21 FRAMEWIN\_GetText()

#### Description

Returns the title text.

#### Prototype

```
void FRAMEWIN_GetText(FRAMEWIN_Handle hObj,  
                      char * pBuffer,  
                      int MaxLen);
```

#### Parameters

Parameter	Description
<a href="#">hObj</a>	Handle of FRAMEWIN widget.
<a href="#">pBuffer</a>	Pointer to buffer to be filled with the title text.
<a href="#">MaxLen</a>	Buffer size in bytes.

#### Additional information

If the buffer size is smaller than the title text the function copies [MaxLen](#) .

### 7.2.9.4.1.22 FRAMEWIN\_GetTextAlign()

#### Description

Returns the text alignment of the title text.

#### Prototype

```
int FRAMEWIN_GetTextAlign(FRAMEWIN_Handle hObj);
```

#### Parameters

Parameter	Description
<a href="#">hObj</a>	Handle of FRAMEWIN widget.

#### Return value

The currently used text alignment. For details about text alignment, refer to `GUI_SetTextAlign()`.

### 7.2.9.4.1.23 FRAMEWIN\_GetTitleHeight()

#### Description

Returns the height of title bar of the given FRAMEWIN widget.

#### Prototype

```
int FRAMEWIN_GetTitleHeight(FRAMEWIN_Handle hObj);
```

#### Parameters

Parameter	Description
<a href="#">hObj</a>	Handle of FRAMEWIN widget

#### Return value

The height of title bar of the given FRAMEWIN widget. For more information about the title height, refer to *FRAMEWIN\_SetDefaultTitleHeight* on page 1439.

#### 7.2.9.4.1.24 FRAMEWIN\_GetUserData()

##### **Description**

Prototype explained at the beginning of the chapter as `<WIDGET>_GetUserData()` on page 1165.

### 7.2.9.4.1.25 FRAMEWIN\_IsMinimized()

#### Description

Returns if the FRAMEWIN widget is minimized or not.

#### Prototype

```
int FRAMEWIN_IsMinimized(FRAMEWIN_Handle hObj);
```

#### Parameters

Parameter	Description
<a href="#">hObj</a>	Handle of FRAMEWIN widget

#### Return value

1 if the FRAMEWIN widget is minimized  
0 if not.



### 7.2.9.4.1.26 FRAMEWIN\_IsMaximized()

#### Description

Returns if the FRAMEWIN widget is maximized or not.

#### Prototype

```
int FRAMEWIN_IsMaximized(FRAMEWIN_Handle hObj);
```

#### Parameters

Parameter	Description
<a href="#">hObj</a>	Handle of FRAMEWIN widget

#### Return value

1 if the FRAMEWIN widget is maximized  
0 if not.

### 7.2.9.4.1.27 FRAMEWIN\_Maximize()

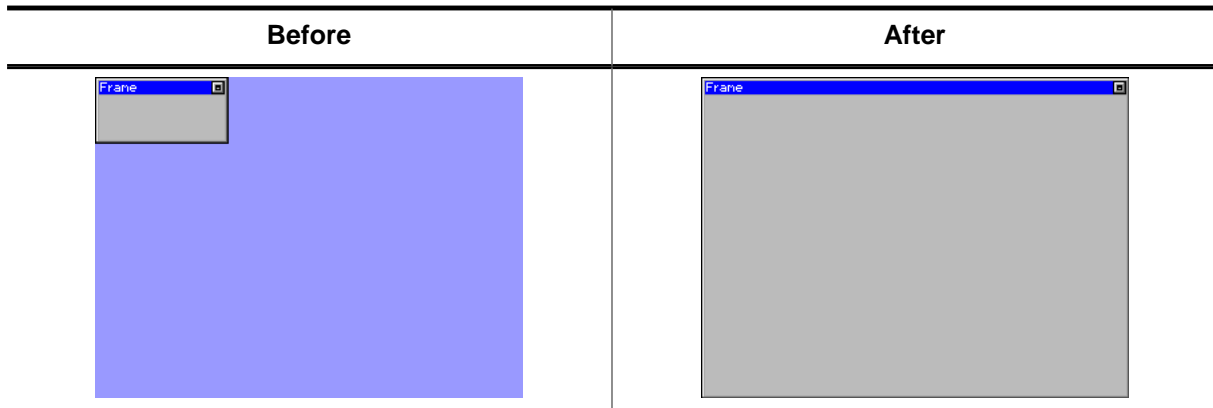

#### Description

Enlarges a FRAMEWIN widget to the size of its parent window.

#### Prototype

```
void FRAMEWIN_Maximize(FRAMEWIN_Handle hObj);
```

#### Parameters

Parameter	Description
hObj	Handle of FRAMEWIN widget

#### Additional information

When calling this function the FRAMEWIN widget will show the same behavior as when the user presses the maximize button. The FRAMEWIN widget will be enlarged to the size of its parent window.

### 7.2.9.4.1.28 FRAMEWIN\_Minimize()



#### Description

Hides the client area of the given FRAMEWIN widget.

#### Prototype

```
void FRAMEWIN_Minimize(FRAMEWIN_Handle hObj);
```

#### Parameters

Parameter	Description
hObj	Handle of FRAMEWIN widget

#### Additional information

When calling this function the FRAMEWIN widget will show the same behavior as when the user presses the minimize button. The FRAMEWIN widget will be enlarged and only the title bar remains visible.

### 7.2.9.4.1.29 FRAMEWIN\_OwnerDraw()

#### Note

OwnerDraw routines for FRAMEWIN widgets are deprecated and only work in conjunction the classic skin.

#### Description

Default function for drawing the title bar of a FRAMEWIN widget.

#### Prototype

```
int FRAMEWIN_OwnerDraw(const WIDGET_ITEM_DRAW_INFO * pDrawItemInfo);
```

#### Parameters

Parameter	Description
<code>pDrawItemInfo</code>	Pointer to a WIDGET_ITEM_DRAW_INFO structure.

#### Return value

Returns 0.

#### Additional information

This function is useful if `FRAMEWIN_SetOwnerDraw()` is used. It should be called for all unhandled commands passed to the owner draw function. For more information, refer to the section explaining user drawn widgets and `FRAMEWIN_SetOwnerDraw()`.

### 7.2.9.4.1.30 FRAMEWIN\_Restore()



#### Description

Restores a minimized or maximized FRAMEWIN widget to its old size and position.

#### Prototype

```
void FRAMEWIN_Restore(FRAMEWIN_Handle hObj);
```

#### Parameters

Parameter	Description
hObj	Handle of FRAMEWIN widget.

#### Return value

Returns 0.

#### Additional information

If the given FRAMEWIN widget is neither maximized nor minimized the function takes no effect.

### 7.2.9.4.1.31 FRAMEWIN\_SetActive()



#### Description

Sets the state of a specified FRAMEWIN widget. Depending on the state, the color of the title bar will change.

#### Prototype

```
void FRAMEWIN_SetActive(FRAMEWIN_Handle hObj,
                       int State);
```

#### Parameters

Parameter	Description
<code>hObj</code>	Handle of FRAMEWIN widget.
<code>State</code>	See <i>FRAMEWIN states</i> on page 1454 for a full list of permitted values.

#### Return value

Returns 0.

#### Additional information

This function is obsolete. If pointing with an input device to a child of a FRAMEWIN widget the FRAMEWIN widget will become active automatically. It is not recommended to use this function. If using this function to set a FRAMEWIN widget to active state, it is not warranted that the state becomes inactive if another FRAMEWIN widget becomes active.

### 7.2.9.4.1.32 FRAMEWIN\_SetBarColor()



#### Description

Sets the color of the title bar of a specified FRAMEWIN widget.

#### Prototype

```
void FRAMEWIN_SetBarColor(FRAMEWIN_Handle hObj,
                          unsigned Index,
                          GUI_COLOR Color);
```

#### Parameters

Parameter	Description
<code>hObj</code>	Handle of FRAMEWIN widget.
<code>Index</code>	See <i>FRAMEWIN states</i> on page 1454 for a full list of permitted values.
<code>Color</code>	<code>Color</code> to be set.

### 7.2.9.4.1.33 FRAMEWIN\_SetBorderSize()



#### Description

Sets the border size of a specified FRAMEWIN widget.

#### Prototype

```
void FRAMEWIN_SetBorderSize(FRAMEWIN_Handle hObj,
                           unsigned        Size);
```

#### Parameters

Parameter	Description
hObj	Handle of FRAMEWIN widget.
Size	New border size of the FRAMEWIN widget.

#### Additional information

This function has no effect when using Flex Skin (default).



### 7.2.9.4.1.34 FRAMEWIN\_SetClientColor()



#### Description

Sets the color of the client window area of a specified FRAMEWIN widget.

#### Prototype

```
void FRAMEWIN_SetClientColor(FRAMEWIN_Handle hObj,
                             GUI_COLOR      Color);
```

#### Parameters

Parameter	Description
hObj	Handle of FRAMEWIN widget.
Color	Color to be set.

### 7.2.9.4.1.35 FRAMEWIN\_SetDefaultBarColor()

#### Description

Sets the default color for title bars in FRAMEWIN widgets.

#### Prototype

```
void FRAMEWIN_SetDefaultBarColor(unsigned Index,  
                                GUI_COLOR Color);
```

#### Parameters

Parameter	Description
<a href="#">Index</a>	See <i>FRAMEWIN states</i> on page 1454 for a full list of permitted values.
<a href="#">Color</a>	<a href="#">Color</a> to be set.

### 7.2.9.4.1.36 FRAMEWIN\_SetDefaultBorderSize()

#### Description

Sets the default border size of FRAMEWIN widgets.

#### Prototype

```
void FRAMEWIN_SetDefaultBorderSize(int DefaultBorderSize);
```

#### Parameters

Parameter	Description
<code>BorderSize</code>	Size to be set.

### 7.2.9.4.1.37 FRAMEWIN\_SetDefaultClientColor()

#### Description

Sets the default color for client areas in FRAMEWIN widgets.

#### Prototype

```
void FRAMEWIN_SetDefaultClientColor(GUI_COLOR Color);
```

#### Parameters

Parameter	Description
Color	Color to be set.

### 7.2.9.4.1.38 FRAMEWIN\_SetDefaultFont()

#### Description

Sets the default font used to display the title in FRAMEWIN widgets.

#### Prototype

```
void FRAMEWIN_SetDefaultFont(const GUI_FONT * pFont);
```

#### Parameters

Parameter	Description
<code>pFont</code>	Pointer to font to be used as default.

### 7.2.9.4.1.39 FRAMEWIN\_SetDefaultTextColor()

#### Description

Sets the default text color of the title.

#### Prototype

```
void FRAMEWIN_SetDefaultTextColor(unsigned Index,  
                                  GUI_COLOR Color);
```

#### Parameters

Parameter	Description
<a href="#">Index</a>	See <i>FRAMEWIN</i> states on page 1454 for a full list of permitted values.
<a href="#">Color</a>	<a href="#">Color</a> to be used.

#### 7.2.9.4.1.40 FRAMEWIN\_SetDefaultTitleHeight()

##### Description

Sets the size in Y for the title bar.

##### Prototype

```
void FRAMEWIN_SetDefaultTitleHeight(int Height);
```

##### Parameters

Parameter	Description
Height	Size to be set

##### Additional information

The default value of the title height is 0. That means the height of the title depends on the font used to display the title text. If the default value is set to a value > 0 each new FRAMEWIN widget will use this height for the title height and not the height of the font of the title.

### 7.2.9.4.1.41 FRAMEWIN\_SetFont()



#### Description

Sets the title font of the FRAMEWIN widget.

#### Prototype

```
void FRAMEWIN_SetFont(    FRAMEWIN_Handle  hObj,
                        const GUI_FONT    * pFont);
```

#### Parameters

Parameter	Description
hObj	Handle of FRAMEWIN widget.
pFont	Pointer to the font.



### 7.2.9.4.1.42 FRAMEWIN\_SetMoveable()

#### Description

Sets a FRAMEWIN widget to a moveable or fixed state.

#### Prototype

```
void FRAMEWIN_SetMoveable(FRAMEWIN_Handle hObj,
                          int State);
```

#### Parameters

Parameter	Description
<code>hObj</code>	Handle of FRAMEWIN widget.
<code>State</code>	<code>State</code> of frame window. See table below.

Permitted values for parameter <code>State</code>	
0	Frame window is fixed (non-moveable).
1	Frame window is moveable.

#### Additional information

The default state of a FRAMEWIN widget after creation is fixed. Moveable state means, the FRAMEWIN widget can be dragged with a pointer input device (PID). To move the FRAMEWIN widget, it first needs to be touched with a PID in pressed state in the title area. Moving the pressed PID now moves also the widget. If the `config` macro `FRAMEWIN_ALLOW_DRAG_ON_FRAME` is 1 (default), the FRAMEWIN widget can also be dragged on the surrounding frame. This works only if the FRAMEWIN widget is not in resizable state.

### 7.2.9.4.1.43 FRAMEWIN\_SetOwnerDraw()

#### Note

OwnerDraw routines for FRAMEWIN widgets are deprecated and only work in conjunction the classic skin.

#### Description

Enables the FRAMEWIN widget to be owner drawn.

#### Prototype

```
void FRAMEWIN_SetOwnerDraw(FRAMEWIN_Handle hObj,
                           WIDGET_DRAW_ITEM_FUNC * pfDrawItem);
```

#### Parameters

Parameter	Description
<code>hObj</code>	Handle of FRAMEWIN widget.
<code>pfDrawItem</code>	Pointer to owner draw function.

#### Supported commands

- WIDGET\_ITEM\_DRAW

#### Additional information

This function sets a function pointer to a function which will be called by the widget if a FRAMEWIN widget has to be drawn. It gives you the possibility to draw a complete customized title bar, not just plain text. `pfDrawItem` is a pointer to an application-defined function of type `WIDGET_DRAW_ITEM_FUNC` which is explained at the beginning of the chapter.

#### Example

The following shows a typical owner draw function:

```
int _OwnerDraw(const WIDGET_DRAW_ITEM_INFO * pDrawItemInfo) {
    GUI_RECT Rect;
    char acBuffer[20];
    switch (pDrawItemInfo->Cmd) {
    case WIDGET_ITEM_DRAW:
        Rect.x0 = pDrawItemInfo->x0 + 1;
        Rect.x1 = pDrawItemInfo->x1 - 1;
        Rect.y0 = pDrawItemInfo->y0 + 1;
        Rect.y1 = pDrawItemInfo->y1;
        FRAMEWIN_GetText(pDrawItemInfo->hWin, acBuffer, sizeof(acBuffer));
        GUI_DrawGradientH(pDrawItemInfo->x0, pDrawItemInfo->y0,
                        pDrawItemInfo->x1, pDrawItemInfo->y1,
                        GUI_RED, GUI_GREEN);
        GUI_SetFont(FRAMEWIN_GetFont(pDrawItemInfo->hWin));
        GUI_SetTextMode(GUI_TM_TRANS);
        GUI_SetColor(GUI_YELLOW);
        GUI_DispStringInRect(acBuffer, &Rect,
                            FRAMEWIN_GetTextAlign(pDrawItemInfo->hWin));
        return 0;
    }
    return FRAMEWIN_OwnerDraw(pDrawItemInfo);
}

void CreateFrameWindow(void) {
    ...
    FRAMEWIN_SetOwnerDraw(hWin, _OwnerDraw);
    ...
}
```

```
}
```

### Screenshot of above example



#### 7.2.9.4.1.44 FRAMEWIN\_SetResizable()

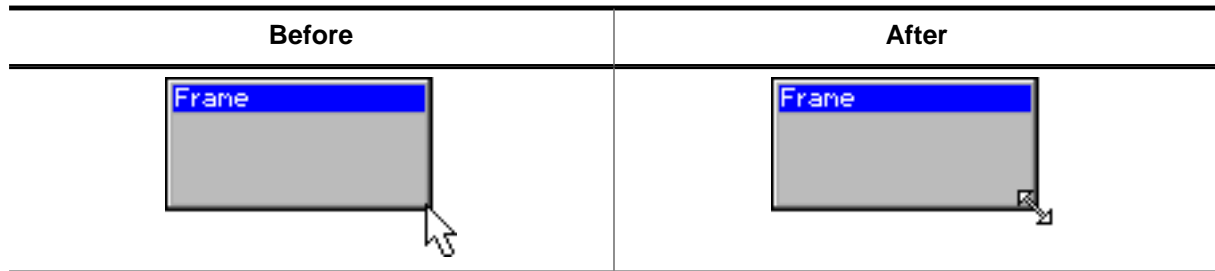

#### Description

Sets the resizable state of the given FRAMEWIN widget.

#### Prototype

```
void FRAMEWIN_SetResizable(FRAMEWIN_Handle hObj,
                           int             State);
```

#### Parameters

Parameter	Description
<code>hObj</code>	Handle of FRAMEWIN widget.
<code>State</code>	1 if the frame window should be resizable, 0 if not.

#### Additional information

If the FRAMEWIN widget is in resizable state its size can be changed by dragging the borders. If a pointer input device points over the border, the cursor will change to a resize cursor (if cursor is on and if optional mouse support is enabled). If pointing to the edge of the border, the X and Y size of the window can be changed simultaneously.

### 7.2.9.4.1.45 FRAMEWIN\_SetText()



#### Description

Sets the title text.

#### Prototype

```
void FRAMEWIN_SetText(    FRAMEWIN_Handle  hObj,
                        const char      * s);
```

#### Parameters

Parameter	Description
hObj	Handle of FRAMEWIN widget.
s	Text to display as the title.

### 7.2.9.4.1.46 FRAMEWIN\_SetTextAlign()



#### Description

Sets the text alignment of the title bar.

#### Prototype

```
void FRAMEWIN_SetTextAlign(FRAMEWIN_Handle hObj,
                           int Align);
```

#### Parameters

Parameter	Description
<code>hObj</code>	Handle of FRAMEWIN widget.
<code>Align</code>	Alignment attribute for the title. List of flags can be found under <i>Text alignment flags</i> on page 286.

#### Additional information

If this function is not called, the default behavior is to display the text centered.

### 7.2.9.4.1.47 FRAMEWIN\_SetTextColor()



#### Description

Sets the color of the title text for both states, active and inactive.

#### Prototype

```
void FRAMEWIN_SetTextColor(FRAMEWIN_Handle hObj,
                           GUI_COLOR      Color);
```

#### Parameters

Parameter	Description
hObj	Handle of FRAMEWIN widget.
Color	Color to be set.

### 7.2.9.4.1.48 FRAMEWIN\_SetTextColorEx()

Before	After
	

#### Description

Sets the text color for the given state.

#### Prototype

```
void FRAMEWIN_SetTextColorEx(FRAMEWIN_Handle hObj,
                             unsigned Index,
                             GUI_COLOR Color);
```

#### Parameters

Parameter	Description
<code>hObj</code>	Handle of FRAMEWIN widget.
<code>Index</code>	See <i>FRAMEWIN states</i> on page 1454 for a full list of permitted values.
<code>Color</code>	<code>Color</code> to be used.



### 7.2.9.4.1.49 FRAMEWIN\_SetTitleHeight()



#### Description

Sets the height of the title bar.

#### Prototype

```
int FRAMEWIN_SetTitleHeight(FRAMEWIN_Handle hObj,
                             int Height);
```

#### Parameters

Parameter	Description
hObj	Handle of FRAMEWIN widget.
Height	Height of the title bar.

#### Additional information

Per default the height of the title bar depends on the size on the font used to display the title text. When using `FRAMEWIN_SetTitleHeight()` the height will be fixed to the given value. Changes of the font takes no effect concerning the height of the title bar. A value of 0 will restore the default behavior.

### 7.2.9.4.1.50 FRAMEWIN\_SetTitleVis()



#### Description

Sets the visibility flag of the title bar.

#### Prototype

```
void FRAMEWIN_SetTitleVis(FRAMEWIN_Handle hObj,
                          int Show);
```

#### Parameters

Parameter	Description
hObj	Handle of FRAMEWIN widget.
Show	1 for visible (default), 0 for hidden

#### 7.2.9.4.1.51 FRAMEWIN\_SetUserData()

##### Description

Prototype explained at the beginning of the chapter as `<WIDGET>_SetUserData()` on page 1166.

## 7.2.9.4.2 Defines

### 7.2.9.4.2.1 FRAMEWIN button flags

#### Description

These flags determine on which side of the FRAMEWIN widget a button should be added.

#### Definition

```
#define FRAMEWIN_BUTTON_RIGHT    (1 << 0)
#define FRAMEWIN_BUTTON_LEFT    (1 << 1)
```

#### Symbols

Definition	Description
<a href="#">FRAMEWIN_BUTTON_RIGHT</a>	The BUTTON will be created at the right side.
<a href="#">FRAMEWIN_BUTTON_LEFT</a>	The BUTTON will be created at the left side.

### 7.2.9.4.2 FRAMEWIN create flags

#### Description

Create flags that define the behavior of the FRAMEWIN widget. These flags are OR-combinable and can be specified upon creation of the widget via the `ExFlags` parameter of `FRAMEWIN_CreateEx()`.

#### Definition

```
#define FRAMEWIN_CF_ACTIVE      (1 << 3)
#define FRAMEWIN_CF_MOVEABLE   (1 << 4)
#define FRAMEWIN_CF_TITLEVIS   (1 << 5)
#define FRAMEWIN_CF_MINIMIZED  (1 << 6)
#define FRAMEWIN_CF_MAXIMIZED  (1 << 7)
#define FRAMEWIN_CF_DRAGGING   (1 << 8)
```

#### Symbols

Definition	Description
<code>FRAMEWIN_CF_ACTIVE</code>	Active-state of the frame window. See <code>FRAMEWIN_SetActive()</code> .
<code>FRAMEWIN_CF_MOVEABLE</code>	Sets the frame window to a moveable state. See <code>FRAMEWIN_SetMoveable()</code> .
<code>FRAMEWIN_CF_TITLEVIS</code>	Visibility of the frame window's title. See <code>FRAMEWIN_SetTitleVis()</code> .
<code>FRAMEWIN_CF_MINIMIZED</code>	Minimized-state of the frame window. See <code>FRAMEWIN_Minimize()</code> .
<code>FRAMEWIN_CF_MAXIMIZED</code>	Maximized-state of the frame window. See <code>FRAMEWIN_Maximize()</code> .
<code>FRAMEWIN_CF_DRAGGING</code>	Internal use.

### 7.2.9.4.2.3 FRAMEWIN states

#### Description

State of the FRAMEWIN used for various functions.

#### Definition

```
#define FRAMEWIN_CI_INACTIVE    0
#define FRAMEWIN_CI_ACTIVE     1
```

#### Symbols

Definition	Description
<a href="#">FRAMEWIN_CI_INACTIVE</a>	When the FRAMEWIN is inactive.
<a href="#">FRAMEWIN_CI_ACTIVE</a>	When the FRAMEWIN is active.

### 7.2.9.5 Example

The `Sample` folder contains the following example which shows how the widget can be used:

- `WIDGET_FrameWin.c`

Note that several other examples also make use of this widget and may also be helpful to get familiar with the widget.

**Screenshot of `WIDGET_FrameWin.c`:**



## 7.2.10 GAUGE: Gauge widget

The GAUGE widget displays a value in a certain range like a progress bar, but instead the progress is displayed in a radial manner. A GAUGE consists of two arcs that are drawn, a background line and a foreground line. The foreground line's length shows the set value of the GAUGE widget. Depending on the given angle, the widget can obviously also show two circles instead of two arcs.

### Note

All GAUGE-related routines are in the file(s) `GAUGE.c` and `GAUGE.h`. All identifiers are prefixed with `GAUGE`.

The GAUGE shown below has a gray background line and a green foreground line.



### 7.2.10.1 Configuration options

Type	Macro	Default	Description
N	<code>GAUGE_ALIGN_DEFAULT</code>	<code>GUI_TA_HCENTER</code>   <code>GUI_TA_VCENTER</code>	Alignment of the arc.
N	<code>GAUGE_BKCOLOR_DEFAULT</code>	<code>GUI_BLACK</code>	Background color.
N	<code>GAUGE_COLOR0_DEFAULT</code>	<code>GUI_WHITE</code>	Color of the background line.
N	<code>GAUGE_COLOR1_DEFAULT</code>	<code>GUI_DARKGRAY</code>	Color of the foreground line.

### 7.2.10.2 Predefined IDs

The following symbols define IDs which may be used to make GAUGE widgets distinguishable from creation.

```
#define GUI_ID_GAUGE0    0x340
#define GUI_ID_GAUGE1    0x341
#define GUI_ID_GAUGE2    0x342
#define GUI_ID_GAUGE3    0x343
#define GUI_ID_GAUGE4    0x344
#define GUI_ID_GAUGE5    0x345
#define GUI_ID_GAUGE6    0x346
#define GUI_ID_GAUGE7    0x347
#define GUI_ID_GAUGE8    0x348
#define GUI_ID_GAUGE9    0x349
```



### 7.2.10.3 Notification codes

The following events are sent from a GAUGE widget to its parent window as part of a WM\_NOTIFY\_PARENT message:

Message	Description
WM_NOTIFICATION_VALUE_CHANGED	The value of the GAUGE widget has been changed.

### 7.2.10.4 Keyboard reaction

The widget can not receive input focus and therefore does not react on any keys.

### 7.2.10.5 GAUGE API

The table below lists the available emWin GAUGE-related routines in alphabetical order. Detailed descriptions of the routines follow.

#### Functions

Routine	Description
<code>GAUGE_CreateIndirect()</code>	Creates a GAUGE widget from a resource table entry.
<code>GAUGE_CreateUser()</code>	Creates a GAUGE widget.
<code>GAUGE_EnableCCW()</code>	When enabled, the widget works counterclockwise.
<code>GAUGE_GetArcPositions()</code>	Returns the start and end positions of the given arc in client coordinates.
<code>GAUGE_GetRange()</code>	Gets the range in angles where the GAUGE will be drawn.
<code>GAUGE_GetValue()</code>	Returns the current value of a GAUGE.
<code>GAUGE_SetAlign()</code>	Sets the alignment of the arc drawn in the GAUGE widget.
<code>GAUGE_SetBkColor()</code>	Sets the background color of the GAUGE widget.
<code>GAUGE_SetColor()</code>	Sets the color of the line drawn in the GAUGE widget.
<code>GAUGE_SetOffset()</code>	Sets an X and Y offset to the arc drawn in the GAUGE widget.
<code>GAUGE_SetRadius()</code>	Sets the radius of the GAUGE.
<code>GAUGE_SetRange()</code>	Sets the range in angles where the GAUGE will be drawn.
<code>GAUGE_SetRoundedEnd()</code>	When enabled, the background line will be drawn with a rounded edge on the ends.
<code>GAUGE_SetRoundedValue()</code>	When enabled, the foreground line will be drawn with a rounded edge on the ends.
<code>GAUGE_SetValue()</code>	Sets a new value for the GAUGE widget.
<code>GAUGE_SetValueRange()</code>	Defines the range of the values shown by the GAUGE widget.
<code>GAUGE_SetWidth()</code>	Sets the width of the line drawn in the GAUGE widget.

#### Defines

Group of defines	Description
<code>GAUGE_curved_flags</code>	Define if the GAUGE's arcs should have rounded edges.



## 7.2.10.5.1 Functions

### 7.2.10.5.1.1 GAUGE\_CreateIndirect()

#### Description

Prototype explained at the beginning of the chapter as `<WIDGET>_CreateIndirect()` on page 1161. The elements `Flags` and `Para` of the resource passed as parameter are not used.

### 7.2.10.5.1.2 GAUGE\_CreateUser()

#### Description

Creates a GAUGE widget.

#### Prototype

```
GAUGE_Handle GAUGE_CreateUser(int    x0,
                               int    y0,
                               int    xSize,
                               int    ySize,
                               WM_HWIN hParent,
                               int    WinFlags,
                               int    ExFlags,
                               int    Id,
                               int    NumExtraBytes);
```

#### Parameters

Parameter	Description
<code>x0</code>	Leftmost pixel of the GAUGE widget (in parent coordinates).
<code>y0</code>	Topmost pixel of the GAUGE widget (in parent coordinates).
<code>xSize</code>	Horizontal size of the GAUGE widget (in pixels).
<code>ySize</code>	Vertical size of the GAUGE widget (in pixels).
<code>hParent</code>	Parent window of the GAUGE widget.
<code>WinFlags</code>	Window create flags. Typically <code>WM_CF_SHOW</code> in order to make the widget visible immediately (refer to <i>Window create flags</i> on page 1146 for a list of available parameter values).
<code>ExFlags</code>	See <i>GAUGE curved flags</i> on page 1476.
<code>Id</code>	ID of the GAUGE widget.
<code>NumExtraBytes</code>	Number of extra bytes to be allocated.

#### Return value

Handle of the GAUGE widget.

### 7.2.10.5.1.3 GAUGE\_EnableCCW()

#### Description

When enabled, the widget works counterclockwise.

#### Prototype

```
void GAUGE_EnableCCW(GAUGE_Handle hObj,  
                    int OnOff);
```

#### Parameters

Parameter	Description
<code>hObj</code>	Handle of GAUGE widget.
<code>OnOff</code>	1 for enabling, 0 for disabling.

#### 7.2.10.5.1.4 GAUGE\_GetArcPositions()

##### Description

Returns the start and end positions of the given arc in client coordinates.

##### Prototype

```
void GAUGE_GetArcPositions(GAUGE_Handle  hObj,  
                          unsigned      Index,  
                          GUI_POINT     * pStart,  
                          GUI_POINT     * pEnd);
```

##### Parameters

Parameter	Description
<code>hObj</code>	Handle of GAUGE widget.
<code>Index</code>	Line index, 0 for the background line, 1 for the foreground line.
<code>pStart</code>	<code>out</code> Output starting position of the arc.
<code>pEnd</code>	<code>out</code> Output ending position of the arc.

### 7.2.10.5.1.5 GAUGE\_GetValue()

#### Description

Returns the current value of a GAUGE.

#### Prototype

```
I32 GAUGE_GetValue(GAUGE_Handle hObj);
```

#### Parameters

Parameter	Description
<a href="#">hObj</a>	Handle of GAUGE widget.

#### Return value

Value of the GAUGE widget.

### 7.2.10.5.1.6 GAUGE\_GetRange()

#### Description

Gets the range in angles where the GAUGE will be drawn.

#### Prototype

```
void GAUGE_GetRange(GAUGE_Handle hObj,  
                   I32          * pAng0,  
                   I32          * pAng1);
```

#### Parameters

Parameter	Description
<a href="#">hObj</a>	Handle of GAUGE widget.
<a href="#">pAng0</a>	Pointer to I32 for starting point.
<a href="#">pAng1</a>	Pointer to I32 for ending point.



### 7.2.10.5.1.7 GAUGE\_SetAlign()

#### Description

Sets the alignment of the arc drawn in the GAUGE widget.

#### Prototype

```
void GAUGE_SetAlign(GAUGE_Handle hObj,  
                   int           Align);
```

#### Parameters

Parameter	Description
<code>hObj</code>	Handle of GAUGE widget.
<code>Align</code>	Alignment of the arc in the widget area. <i>Text alignment flags</i> on page 286 can be used.

### 7.2.10.5.1.8 GAUGE\_SetBkColor()

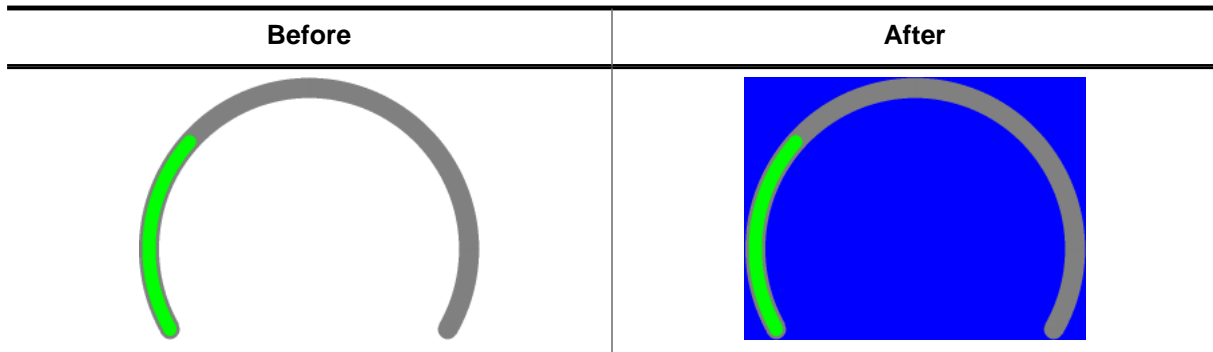

#### Description

Sets the background color of the GAUGE widget.

#### Prototype

```
void GAUGE_SetBkColor(GAUGE_Handle hObj,
                     GUI_COLOR   BkColor);
```

#### Parameters

Parameter	Description
<code>hObj</code>	Handle of GAUGE widget.
<code>BkColor</code>	New background color.

### 7.2.10.5.1.9 GAUGE\_SetColor()

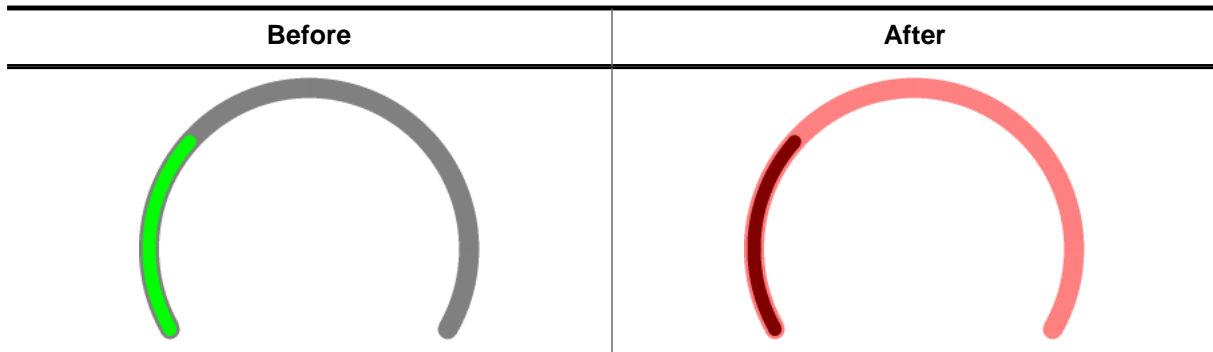

#### Description

Sets the color of the line drawn in the GAUGE widget.

#### Prototype

```
void GAUGE_SetColor(GAUGE_Handle hObj,
                   unsigned      Index,
                   GUI_COLOR      Color);
```

#### Parameters

Parameter	Description
<code>hObj</code>	Handle of GAUGE widget.
<code>Index</code>	Line index, 0 for the background line, 1 for the foreground line.
<code>Color</code>	<code>Color</code> of the specified line.

### 7.2.10.5.1.10 GAUGE\_SetOffset()

#### Description

Sets an X and Y offset to the arc drawn in the GAUGE widget.

#### Prototype

```
void GAUGE_SetOffset(GAUGE_Handle hObj,  
                    int           xOff,  
                    int           yOff);
```

#### Parameters

Parameter	Description
<a href="#">hObj</a>	Handle of GAUGE widget.
<a href="#">xOff</a>	X-offset in pixels.
<a href="#">yOff</a>	Y-offset in pixels.

### 7.2.10.5.1.11 GAUGE\_SetRadius()

#### Description

Sets the radius of the GAUGE.

#### Prototype

```
void GAUGE_SetRadius(GAUGE_Handle hObj,  
                    int           Radius);
```

#### Parameters

Parameter	Description
<a href="#">hObj</a>	Handle of GAUGE widget.
<a href="#">Radius</a>	<a href="#">Radius</a> to be used.

### 7.2.10.5.1.12 GAUGE\_SetRange()

#### Description

Sets the range in angles where the GAUGE will be drawn.

#### Prototype

```
void GAUGE_SetRange(GAUGE_Handle hObj,  
                   I32           Ang0,  
                   I32           Ang1);
```

#### Parameters

Parameter	Description
<a href="#">hObj</a>	Handle of GAUGE widget.
<a href="#">Ang0</a>	Angle of starting point.
<a href="#">Ang1</a>	Angle of ending point.

#### Additional information

The angles have to be specified in 100th of degrees. For example, 90° equals to 9000.

### 7.2.10.5.1.13 GAUGE\_SetRoundedEnd()

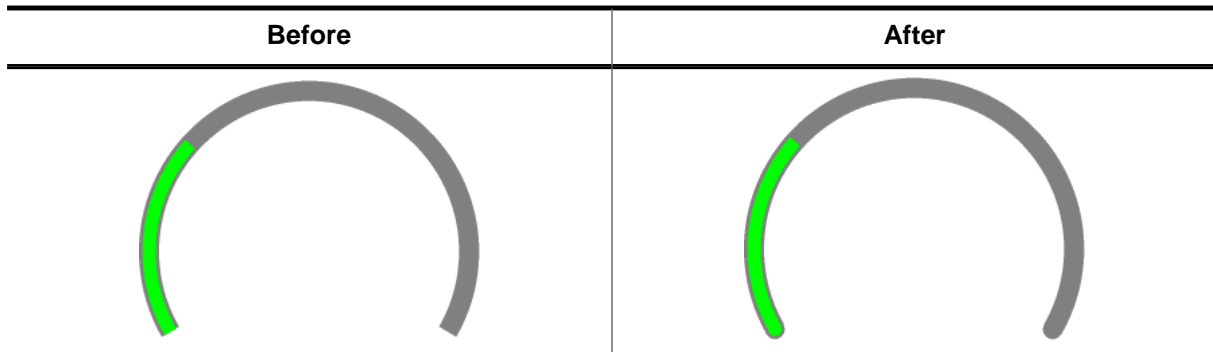

#### Description

When enabled, the background line will be drawn with a rounded edge on the ends.

#### Prototype

```
void GAUGE_SetRoundedEnd(GAUGE_Handle hObj,  
                          int          OnOff);
```

#### Parameters

Parameter	Description
<code>hObj</code>	Handle of GAUGE widget.
<code>OnOff</code>	1 for enabling, 0 for disabling.

### 7.2.10.5.1.14 GAUGE\_SetRoundedValue()

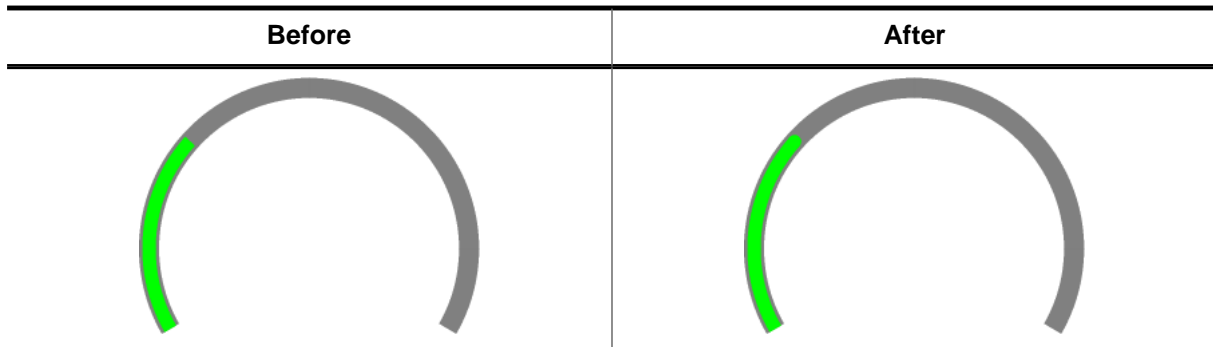

#### Description

When enabled, the foreground line will be drawn with a rounded edge on the ends. The foreground line is the line that displays the GAUGE's value.

#### Prototype

```
void GAUGE_SetRoundedValue(GAUGE_Handle hObj,
                           int          OnOff);
```

#### Parameters

Parameter	Description
<code>hObj</code>	Handle of GAUGE widget.
<code>OnOff</code>	1 for enabling, 0 for disabling.



### 7.2.10.5.1.15 GAUGE\_SetValue()

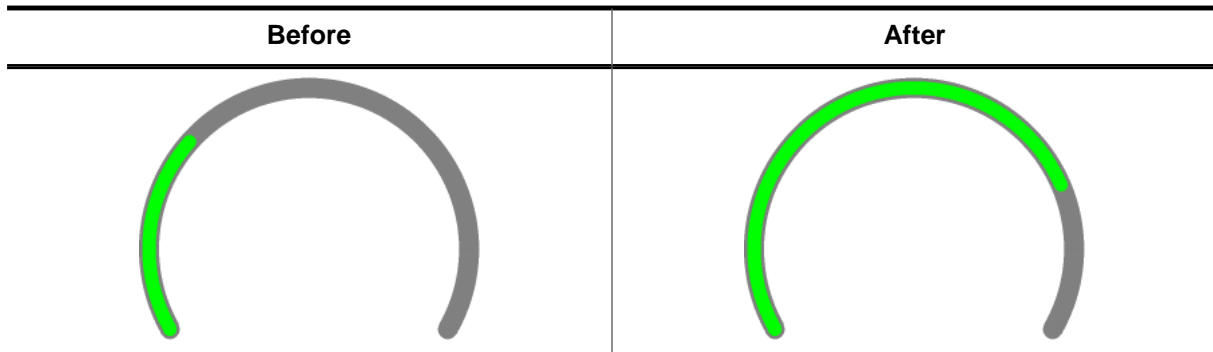

#### Description

Sets a new value for the GAUGE widget.

#### Prototype

```
void GAUGE_SetValue(GAUGE_Handle hObj,  
                   I32          Value);
```

#### Parameters

Parameter	Description
hObj	Handle of GAUGE widget.
Value	New value to be set.

### 7.2.10.5.1.16 GAUGE\_SetValueRange()

#### Description

Defines the range of the values shown by the GAUGE widget.

#### Prototype

```
void GAUGE_SetValueRange(GAUGE_Handle hObj,  
                          I32          Min,  
                          I32          Max);
```

#### Parameters

Parameter	Description
<a href="#">hObj</a>	Handle of GAUGE widget.
<a href="#">Min</a>	Minimum value to be set.
<a href="#">Max</a>	Maximum value to be set.

### 7.2.10.5.1.17 GAUGE\_SetWidth()

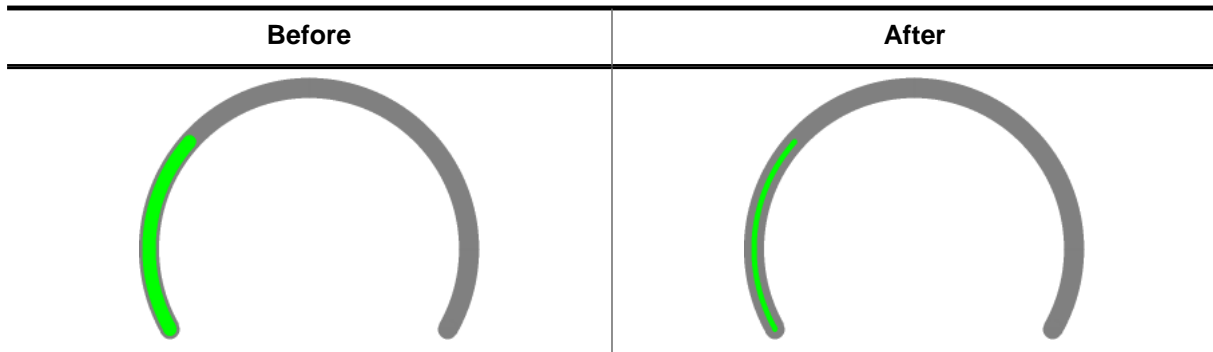

#### Description

Sets the width of the line drawn in the GAUGE widget.

#### Prototype

```
void GAUGE_SetWidth(GAUGE_Handle hObj,
                   unsigned Index,
                   int Width);
```

#### Parameters

Parameter	Description
<code>hObj</code>	Handle of GAUGE widget.
<code>Index</code>	Line index, 0 for the background line, 1 for the foreground line.
<code>Width</code>	<code>Width</code> of the specified line.

## 7.2.10.5.2 Defines

### 7.2.10.5.2.1 GAUGE curved flags

#### Description

With these flags the drawing of the widget's arc lines can be set to have round edges. The flags can be used upon creation of the GAUGE widget.

#### Definition

```
#define GAUGE_CURVED_VALUE      (1 << 0)
#define GAUGE_CURVED_END       (1 << 1)
#define GAUGE_DIRECTION_CCW    (1 << 2)
```

#### Symbols

Definition	Description
<a href="#">GAUGE_CURVED_VALUE</a>	The arc that is drawn for the GAUGE's value will have a curved edge on the beginning and end of the line.
<a href="#">GAUGE_CURVED_END</a>	The background arc will be drawn with a curved edge on the beginning and end of the line.
<a href="#">GAUGE_DIRECTION_CCW</a>	Widget works counterclockwise

## 7.2.11 GRAPH: Graph widget

GRAPH widgets can be used to visualize data. Typical applications for GRAPH widgets are showing measurement values or the curve of a function graph. Multiple curves can be shown simultaneously. Horizontal and vertical scales can be used to label the curves. A grid with different horizontal and vertical spacing can be shown on the background. If the data array does not fit into the visible area of the graph, the widget can automatically show scroll bars which allow scrolling through large data arrays.

### 7.2.11.1 Structure of the graph widget

A GRAPH widget consists of different kinds of objects:

- The GRAPH widget itself to which data objects and scale objects can be attached.
- Optionally one or more data objects.
- Optionally one or more scale objects.

The following diagram shows the detailed structure of a graph widget:

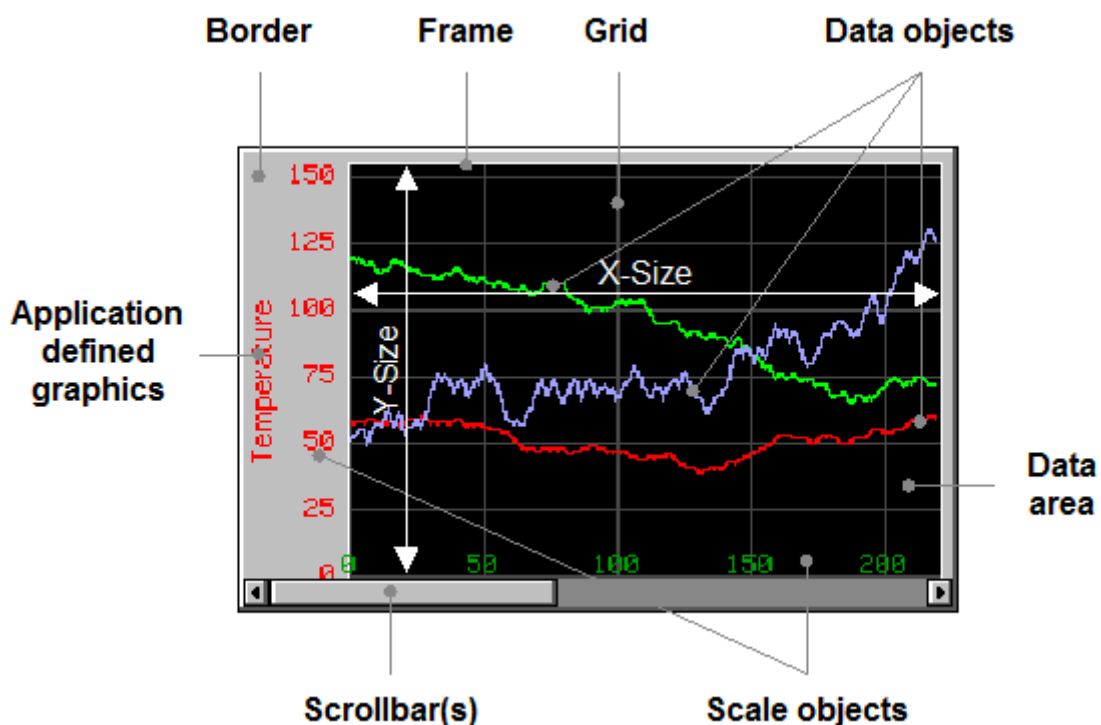

The following table explains the details of the diagram above:

Detail	Description
Border	The optional border is part of the graph widget.
Frame	A thin line around the data area, part of the graph widget.
Grid	Shown in the background of the data area, part of the graph widget.
Data area	Area, in which grid and data objects are shown.
Data object(s)	For each curve one data object should be added to the graph widget.
Application defined graphic	An application defined callback function can be used to draw any application defined text and/or graphics.
Scrollbar(s)	If the range of the data object is bigger than the data area of the graph widget, the graph widget can automatically show a horizontal and/or a vertical scroll bar.

Detail	Description
<a href="#">Scale object(s)</a>	Horizontal and vertical scales can be attached to the graph widget.
<a href="#">X-Size</a>	X-Size of the data area.
<a href="#">Y-Size</a>	Y-Size of the data area.

### 7.2.11.2 Creating and deleting a graph widget

The process of creating a GRAPH widget should be the following:

1. Create the GRAPH widget and set the desired attributes.
2. Create the data object(s).
3. Attach the data object(s) to the GRAPH widget.
4. Create the optional scale object(s).
5. Attach the scale object(s) to the GRAPH widget.

Once attached to the graph widget the data and scale objects need not to be deleted by the application. This is done by the graph widget.

#### Example

The following shows a small example how to create and delete a GRAPH widget:

```
GRAPH_DATA_Handle  hData;
GRAPH_SCALE_Handle hScale;
WM_HWIN hGraph;
hGraph = GRAPH_CreateEx(10, 10, 216, 106, WM_HBKWIN, WM_CF_SHOW, 0, GUI_ID_GRAPH0);
hData
    = GRAPH_DATA_YT_Create(GUI_DARKGREEN, NumDataItems, aData0, MaxNumDataItems);
GRAPH_AttachData(hGraph, hData);
hScale = GRAPH_SCALE_Create(28, GUI_TA_RIGHT, GRAPH_SCALE_CF_VERTICAL, 20);
GRAPH_AttachScale(hGraph, hScale);
/*
  Do something with the widget...
*/
WM_DeleteWindow(hGraph);
```

### 7.2.11.3 Drawing process

As explained above a GRAPH widget consists of different parts and 'sub' objects. The following will explain, in which sequence the widget is drawn:

1. Filling the background with the background color.
2. Calling an optional callback routine. This makes it possible to draw for example a user defined grid.
3. Drawing the grid (if enabled).
4. Drawing the data objects and the border area.
5. Drawing the scale objects.
6. Calling an optional callback routine. This makes it possible to draw for example a user defined scale or some additional text and/or graphics.

### 7.2.11.4 Supported types of curves

The requirements for showing a curve with continuously updated measurement values can be different to the requirements when showing a function graph with X/Y coordinates. For that reason the widget currently supports 2 kinds of data objects, which are shown in the table below:

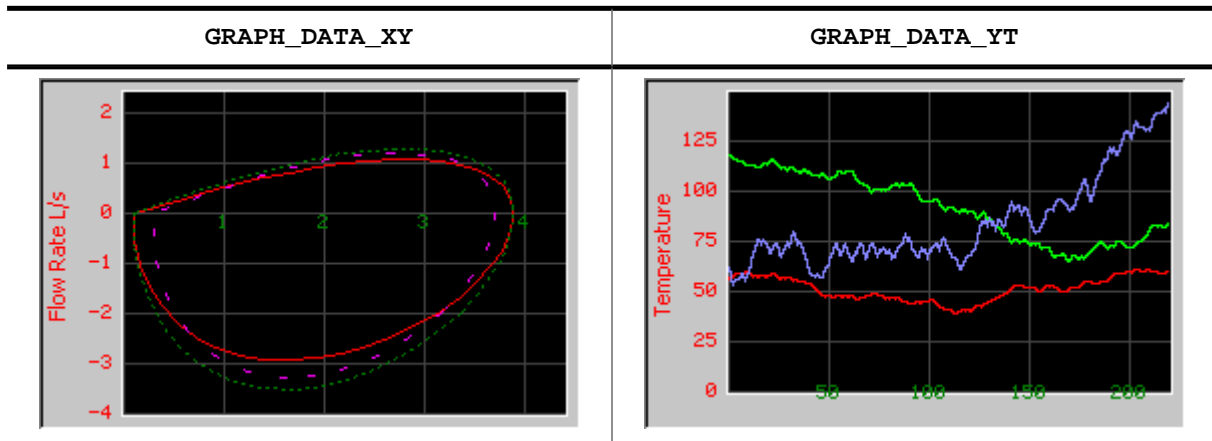

#### 7.2.11.4.1 GRAPH\_DATA\_XY

This data object is used to show curves which consist of an array of points. The object data is drawn as a polyline. A typical application for using this data object is drawing a function graph.

#### 7.2.11.4.2 GRAPH\_DATA\_YT

This data object is used to show curves with one Y-value for each X-position on the graph. A typical application for using this data object is showing a curve with continuously updated measurement values.

### 7.2.11.5 Configuration options

#### 7.2.11.5.1 Graph widget

Type	Macro	Default	Description
N	GRAPH_BKCOLOR_DEFAULT	GUI_BLACK	Default background color of the data area.
N	GRAPH_BORDERCOLOR_DEFAULT	0xC0C0C0	Default background color of the border.
N	GRAPH_FRAMECOLOR_DEFAULT	GUI_WHITE	Default color of the thin frame line.
N	GRAPH_GRIDCOLOR_DEFAULT	GUI_DARKGRAY	Default color used to draw the grid.
N	GRAPH_GRIDSPACING_X_DEFAULT	50	Default horizontal spacing of the grid.
N	GRAPH_GRIDSPACING_Y_DEFAULT	50	Default vertical spacing of the grid.
N	GRAPH_BORDER_L_DEFAULT	0	Default size of the left border.
N	GRAPH_BORDER_T_DEFAULT	0	Default size of the top border.
N	GRAPH_BORDER_R_DEFAULT	0	Default size of the right border.
N	GRAPH_BORDER_B_DEFAULT	0	Default size of the bottom border.

#### 7.2.11.5.2 Scale object

Type	Macro	Default	Description
N	GRAPH_SCALE_TEXTCOLOR_DEFAULT	GUI_WHITE	Default text color.
S	GRAPH_SCALE_FONT_DEFAULT	&GUI_Font6x8	Default font used to draw the values.

### 7.2.11.6 Predefined IDs

The following symbols define IDs which may be used to make GRAPH widgets distinguishable from creation.

```
#define GUI_ID_GRAPH0      0x220
#define GUI_ID_GRAPH1      0x221
#define GUI_ID_GRAPH2      0x222
#define GUI_ID_GRAPH3      0x223
#define GUI_ID_GRAPH4      0x224
#define GUI_ID_GRAPH5      0x225
#define GUI_ID_GRAPH6      0x226
#define GUI_ID_GRAPH7      0x227
#define GUI_ID_GRAPH8      0x228
#define GUI_ID_GRAPH9      0x229
```

### 7.2.11.7 Keyboard reaction

The widget can not gain the input focus and does not react on keyboard input.

### 7.2.11.8 GRAPH API

The table below lists the available emWin GRAPH-related routines in alphabetical order. Detailed descriptions of the routines follow.

#### Functions

Routine	Description
Common routines	
<a href="#">GRAPH_AttachData()</a>	Attaches a data object to an existing GRAPH widget.
<a href="#">GRAPH_AttachScale()</a>	Attaches a scale object to an existing GRAPH widget.
<a href="#">GRAPH_CreateEx()</a>	Creates a GRAPH widget.
<a href="#">GRAPH_CreateIndirect()</a>	Creates a GRAPH widget from a resource table entry.
<a href="#">GRAPH_CreateUser()</a>	Creates a GRAPH widget using extra bytes as user data.
<a href="#">GRAPH_DetachData()</a>	Detaches a data object from a GRAPH widget.
<a href="#">GRAPH_DetachScale()</a>	Detaches a scale object from a GRAPH widget.
<a href="#">GRAPH_GetColor()</a>	This function returns one of the colors set for the GRAPH widget.
<a href="#">GRAPH_GetScrollValue()</a>	Returns the current scroll value for the given scrollbar.
<a href="#">GRAPH_GetUserData()</a>	Retrieves the data set with <a href="#">GRAPH_SetUserData()</a> .
<a href="#">GRAPH_InvertScrollbar()</a>	Inverts the direction of the attached scrollbars.
<a href="#">GRAPH_SetAutoScrollbar()</a>	Sets the automatic use of scroll bars.
<a href="#">GRAPH_SetBorder()</a>	Sets the left, top, right and bottom border of the given GRAPH widget.
<a href="#">GRAPH_SetColor()</a>	Sets the desired color of the given GRAPH widget.
<a href="#">GRAPH_SetGridDistX()</a>	Sets the horizontal grid spacing.
<a href="#">GRAPH_SetGridDistY()</a>	Sets the vertical grid spacing.
<a href="#">GRAPH_SetGridFixedX()</a>	Fixes the grid in X-axis.
<a href="#">GRAPH_SetGridOffX()</a>	Adds an offset used to show the vertical grid lines.



Routine	Description
<a href="#">GRAPH_SetGridOffY()</a>	Adds an offset used to show the horizontal grid lines.
<a href="#">GRAPH_SetGridVis()</a>	Sets the visibility of the grid lines.
<a href="#">GRAPH_SetLineStyleH()</a>	Sets the line style used to draw the horizontal grid lines.
<a href="#">GRAPH_SetLineStyleV()</a>	Sets the line style used to draw the vertical grid lines.
<a href="#">GRAPH_SetScrollValue()</a>	Sets the scroll value for the given scroll bar.
<a href="#">GRAPH_SetUserData()</a>	Sets the extra data of a GRAPH widget.
<a href="#">GRAPH_SetUserDraw()</a>	Sets the user draw function.
<a href="#">GRAPH_SetVSizeX()</a>	Sets the virtual size in X-axis.
<a href="#">GRAPH_SetVSizeY()</a>	Sets the virtual size in Y-axis.
GRAPH_DATA_YT related routines	
<a href="#">GRAPH_DATA_YT_AddValue()</a>	Adds a new data item to a GRAPH_DATA_YT object.
<a href="#">GRAPH_DATA_YT_Clear()</a>	Clears all data items of the data object.
<a href="#">GRAPH_DATA_YT_Create()</a>	Creates a GRAPH_DATA_YT object.
<a href="#">GRAPH_DATA_YT_Delete()</a>	Deletes the given data object.
<a href="#">GRAPH_DATA_YT_GetValue()</a>	Returns value for the given index.
<a href="#">GRAPH_DATA_YT_MirrorX()</a>	Mirrors the x-axis of the widget.
<a href="#">GRAPH_DATA_YT_SetAlign()</a>	Sets the alignment of the data.
<a href="#">GRAPH_DATA_YT_SetColor()</a>	This function sets a color for the given data object.
<a href="#">GRAPH_DATA_YT_SetOffY()</a>	Sets a vertical offset used to draw the object data.
GRAPH_DATA_XY related routines	
<a href="#">GRAPH_DATA_XY_AddPoint()</a>	Adds a new data item to a GRAPH_DATA_XY object.
<a href="#">GRAPH_DATA_XY_Clear()</a>	Clears all data items of the data object.
<a href="#">GRAPH_DATA_XY_Create()</a>	Creates a GRAPH_DATA_XY object.
<a href="#">GRAPH_DATA_XY_Delete()</a>	Deletes the given data object.
<a href="#">GRAPH_DATA_XY_GetLineVis()</a>	Returns if the line of the data object is visible.
<a href="#">GRAPH_DATA_XY_GetPoint()</a>	Returns a point for the given index.
<a href="#">GRAPH_DATA_XY_GetPointVis()</a>	Returns if the points of a data object have been made visible.
<a href="#">GRAPH_DATA_XY_SetColor()</a>	This function sets a color for the given data object.
<a href="#">GRAPH_DATA_XY_SetLineStyle()</a>	Sets the line style used to draw the polyline.
<a href="#">GRAPH_DATA_XY_SetLineVis()</a>	Sets the visibility of the data object's line.
<a href="#">GRAPH_DATA_XY_SetOffX()</a>	Sets a horizontal offset used to draw the polyline.
<a href="#">GRAPH_DATA_XY_SetOffY()</a>	Sets a vertical offset used to draw the polyline.
<a href="#">GRAPH_DATA_XY_SetOwnerDraw()</a>	Sets the owner callback function.
<a href="#">GRAPH_DATA_XY_SetPenSize()</a>	Sets the pen size used to draw the polyline.
<a href="#">GRAPH_DATA_XY_SetPointVis()</a>	Makes all points of a data object visible.
Scale related routines	
<a href="#">GRAPH_SCALE_Create()</a>	Creates a GRAPH_SCALE object.
<a href="#">GRAPH_SCALE_Delete()</a>	Deletes the given scale object.
<a href="#">GRAPH_SCALE_SetFactor()</a>	Sets a factor used to calculate the numbers to be drawn.
<a href="#">GRAPH_SCALE_SetFont()</a>	Sets the font used to draw the scale numbers.

Routine	Description
<code>GRAPH_SCALE_SetNumDecs()</code>	Sets the number of post decimal positions to be shown.
<code>GRAPH_SCALE_SetOff()</code>	Sets an offset used to 'shift' the scale object in positive or negative direction.
<code>GRAPH_SCALE_SetPos()</code>	Sets the position for showing the scale object within the GRAPH widget.
<code>GRAPH_SCALE_SetTextColor()</code>	Sets the text color used to draw the numbers.
<code>GRAPH_SCALE_SetTickDist()</code>	Sets the distance from one number to the next.

## Defines

Group of defines	Description
<code>GRAPH alignment flags</code>	Determine the alignment of the date of a graph.
<code>GRAPH color indexes</code>	Color indexes used by the GRAPH widget.
<code>GRAPH create flags</code>	Create flags used for GRAPH widgets.
<code>GRAPH user draw stages</code>	Color indexes used by the GRAPH widget.
<code>SCALE create flags</code>	Create flags used for scale objects.

### 7.2.11.8.1 Common routines

#### 7.2.11.8.1.1 GRAPH\_AttachData()

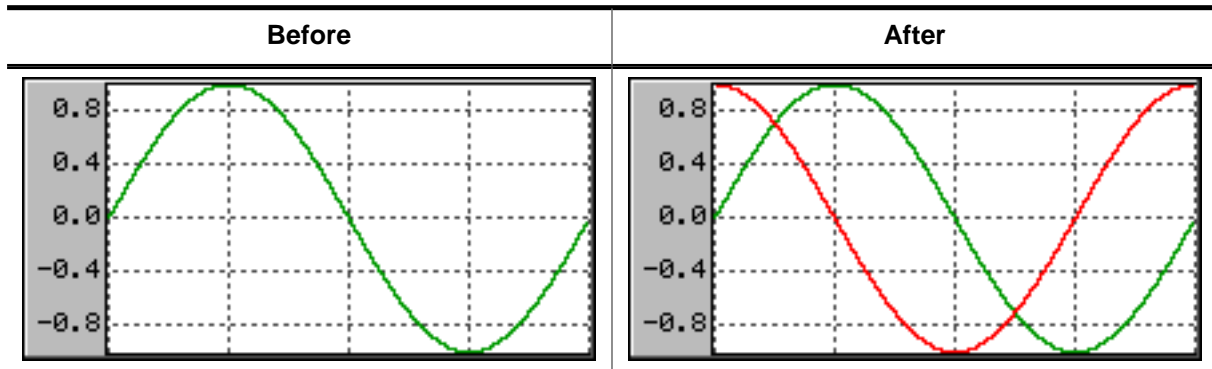

#### Description

Attaches a data object to an existing GRAPH widget.

#### Prototype

```
void GRAPH_AttachData(GRAPH_Handle hObj,
                     GRAPH_DATA_Handle hData);
```

#### Parameters

Parameter	Description
<code>hObj</code>	Handle of GRAPH widget
<code>hData</code>	Handle of the data object to be added to the widget. The data object should be created with <code>GRAPH_DATA_YT_Create()</code> or <code>GRAPH_DATA_XY_Create()</code> .

#### Additional information

Once attached to a GRAPH widget the application does not need to destroy the data object. The GRAPH widget deletes all attached data objects when it is deleted. For details about how to create data objects, refer to `GRAPH_DATA_YT_Create()` and `GRAPH_DATA_XY_Create()`.

### 7.2.11.8.1.2 GRAPH\_AttachScale()

#### Description

Attaches a scale object to an existing GRAPH widget.

#### Prototype

```
void GRAPH_AttachScale(GRAPH_Handle hObj,  
                      GRAPH_SCALE_Handle hScale);
```

#### Parameters

Parameter	Description
<code>hObj</code>	Handle of GRAPH widget
<code>hScale</code>	Handle of the scale to be added.

#### Additional information

Once attached to a GRAPH widget the application does not need to destroy the scale object. The GRAPH widget deletes all attached scale objects when it is deleted. For details about how to create scale objects, refer to *GRAPH\_SCALE\_Create* on page 1532.

### 7.2.11.8.1.3 GRAPH\_CreateEx()

#### Description

Creates a new GRAPH widget of a specified size at a specified location.

#### Prototype

```
GRAPH_Handle GRAPH_CreateEx(int    x0,
                             int    y0,
                             int    xSize,
                             int    ySize,
                             WM_HWIN hParent,
                             int    WinFlags,
                             int    ExFlags,
                             int    Id);
```

#### Parameters

Parameter	Description
<code>x0</code>	Leftmost pixel of the widget (in parent coordinates).
<code>y0</code>	Topmost pixel of the widget (in parent coordinates).
<code>xSize</code>	Horizontal size of the widget (in pixels).
<code>ySize</code>	Vertical size of the widget (in pixels).
<code>hParent</code>	Handle of parent window. If 0, the new button window will be a child of the desktop (top-level window).
<code>WinFlags</code>	Window create flags. Typically <code>WM_CF_SHOW</code> in order to make the widget visible immediately (refer to <i>Window create flags</i> on page 1146 for a list of available parameter values).
<code>ExFlags</code>	See <i>GRAPH create flags</i> on page 1543.
<code>Id</code>	Window <code>Id</code> of the widget.

#### Return value

Handle of the created GRAPH widget; 0 if the function fails.

#### 7.2.11.8.1.4 GRAPH\_CreateIndirect()

##### Description

The prototype of this function is explained at the beginning of this chapter. Details can be found in the description of the function `<WIDGET>_CreateIndirect()` on page 1161. The element `Para` of the according `GUI_WIDGET_CREATE_INFO` structure is not used. The element `Flags` is used according to the parameter `ExFlags` of the function `GRAPH_CreateEx()`.

### 7.2.11.8.1.5 GRAPH\_CreateUser()

#### Description

Prototype explained at the beginning of the chapter as `<WIDGET>_CreateUser()` on page 1162. For a detailed description of the parameters the function `GRAPH_CreateEx()` can be referred to.

### 7.2.11.8.1.6 GRAPH\_DetachData()

#### Description

Detaches a data object from a GRAPH widget.

#### Prototype

```
void GRAPH_DetachData(GRAPH_Handle hObj,  
                      GRAPH_DATA_Handle hData);
```

#### Parameters

Parameter	Description
<a href="#">hObj</a>	Handle of GRAPH widget
<a href="#">hData</a>	Handle of the data object to be detached from the widget.

#### Additional information

Once detached from a GRAPH widget the application needs to destroy the data object. Detaching a data object does not delete it. For more details about deleting data objects, refer to [GRAPH\\_DATA\\_YT\\_Delete\(\)](#) and [GRAPH\\_DATA\\_XY\\_Delete\(\)](#).



### 7.2.11.8.1.7 GRAPH\_DetachScale()

#### Description

Detaches a scale object from a GRAPH widget.

#### Prototype

```
void GRAPH_DetachScale(GRAPH_Handle hObj,  
                       GRAPH_SCALE_Handle hScale);
```

#### Parameters

Parameter	Description
<code>hObj</code>	Handle of GRAPH widget
<code>hScale</code>	Handle of the scale object to be detached from the widget.

#### Additional information

Once detached from a GRAPH widget the application needs to destroy the scale object. Detaching a scale object does not delete it. For more details about deleting scale objects, refer to `GRAPH_SCALE_Delete()`.

### 7.2.11.8.1.8 GRAPH\_GetColor()

#### Description

This function returns one of the colors set for the GRAPH widget.

#### Prototype

```
GUI_COLOR GRAPH_GetColor(GRAPH_Handle hObj,  
                          unsigned      Index);
```

#### Parameters

Parameter	Description
<a href="#">hObj</a>	Handle of GRAPH widget
<a href="#">Index</a>	See <i>GRAPH color indexes</i> on page 1542 for a full list of permitted values.

#### Return value

The color which corresponds to the given index.

### 7.2.11.8.1.9 GRAPH\_GetScrollValue()

#### Description

Returns the current scroll value for the given scroll bar.

#### Prototype

```
I32 GRAPH_GetScrollValue(GRAPH_Handle hObj,  
                          U8          Coord);
```

#### Parameters

Parameter	Description
<a href="#">hObj</a>	Handle of GRAPH widget
<a href="#">Coord</a>	See table below.

Permitted values for parameter <a href="#">Coord</a>	
GUI_COORD_X	Get the horizontal scroll value.
GUI_COORD_Y	Get the vertical scroll value.

#### Return value

Current scroll value. -1, if scroll value could not be determined.

### 7.2.11.8.1.10 GRAPH\_GetUserData()

#### Description

Prototype explained at the beginning of the chapter as `<WIDGET>_GetUserData()` on page 1165.

### 7.2.11.8.1.11 GRAPH\_InvertScrollbar()

#### Description

This function inverts the direction of the attached scrollbars.

#### Prototype

```
void GRAPH_InvertScrollbar(GRAPH_Handle hObj,  
                           U8          Coord);
```

#### Parameters

Parameter	Description
<a href="#">hObj</a>	Handle of GRAPH widget
<a href="#">Coord</a>	See table below.

Permitted values for parameter <a href="#">Coord</a>	
GUI_COORD_X	Inverts the horizontal scrollbar.
GUI_COORD_Y	Inverts the vertical scrollbar.

### 7.2.11.8.1.12 GRAPH\_SetAutoScrollbar()

#### Description

Sets the automatic use of scroll bars.

#### Prototype

```
void GRAPH_SetAutoScrollbar(GRAPH_Handle hObj,
                           U8           Coord,
                           U8           OnOff);
```

#### Parameters

Parameter	Description
<a href="#">hObj</a>	Handle of GRAPH widget
<a href="#">Coord</a>	See table below.
<a href="#">OnOff</a>	1 the scroll bar should be used automatically. 0, if the scroll bar should not be created automatically.

Permitted values for parameter <a href="#">Coord</a>	
GUI_COORD_X	Toggle automatic creation of the horizontal scrollbar.
GUI_COORD_Y	Toggle automatic creation of the vertical scrollbar.

### 7.2.11.8.1.13 GRAPH\_SetBorder()

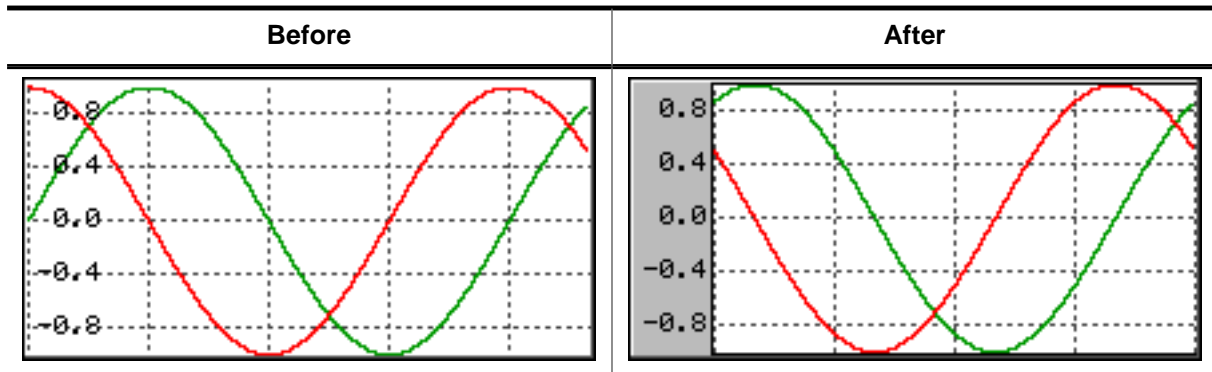

#### Description

Sets the left, top, right and bottom border of the given GRAPH widget.

#### Prototype

```
void GRAPH_SetBorder(GRAPH_Handle hObj,
                    unsigned BorderL,
                    unsigned BorderT,
                    unsigned BorderR,
                    unsigned BorderB);
```

#### Parameters

Parameter	Description
<a href="#">hObj</a>	Handle of GRAPH widget.
<a href="#">BorderL</a>	Size in pixels from the left border.
<a href="#">BorderT</a>	Size in pixels from the top border.
<a href="#">BorderR</a>	Size in pixels from the right border.
<a href="#">BorderB</a>	Size in pixels from the bottom border.

#### Additional information

The border size is the number of pixels between the widget effect frame and the data area of the GRAPH widget. The frame, the thin line around the data area, is only visible if the border size is at least one pixel. For details about how to set the color of the border and the thin frame, refer to [GRAPH\\_SetColor\(\)](#).

### 7.2.11.8.1.14 GRAPH\_SetColor()

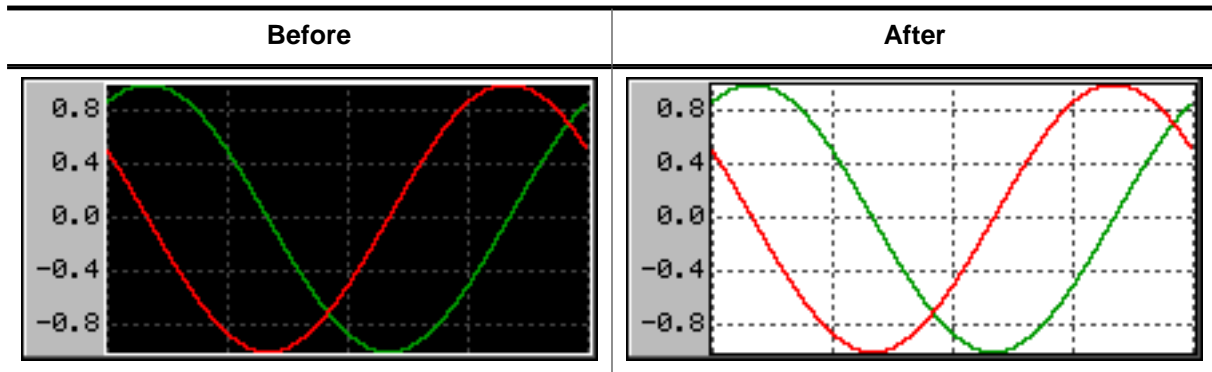

#### Description

Sets the desired color of the given GRAPH widget.

#### Prototype

```
GUI_COLOR GRAPH_SetColor(GRAPH_Handle hObj,
                          GUI_COLOR   Color,
                          unsigned     Index);
```

#### Parameters

Parameter	Description
<code>hObj</code>	Handle of GRAPH widget.
<code>Color</code>	<code>Color</code> to be used for the desired item.
<code>Index</code>	See <i>GRAPH color indexes</i> on page 1542 for a full list of permitted values.

#### Return value

Previous color used for the desired item.

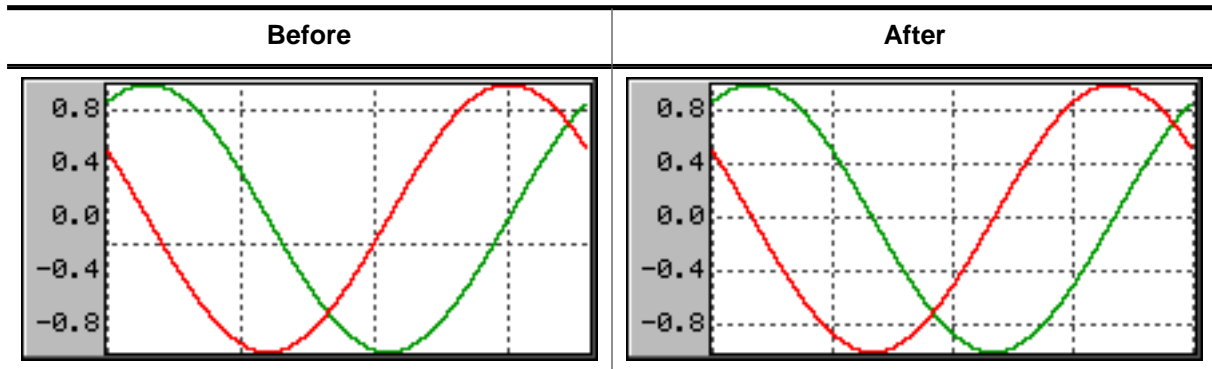

**7.2.11.8.1.15 GRAPH\_SetGridDistX()****7.2.11.8.1.16 GRAPH\_SetGridDistY()****Description**

These functions set the distance from one grid line to the next.

**Prototypes**

```
unsigned GRAPH_SetGridDistX(GRAPH_Handle hObj,
                             unsigned Value);
```

```
unsigned GRAPH_SetGridDistY(GRAPH_Handle hObj,
                             unsigned Value);
```

**Parameters**

Parameter	Description
<a href="#">hObj</a>	Handle of GRAPH widget.
<a href="#">Value</a>	Distance in pixels from one grid line to the next, default is 50 pixel.

**Return value**

Previous grid line distance.

**Additional information**

The first vertical grid line is drawn at the leftmost position of the data area and the first horizontal grid line is drawn at the bottom position of the data area, except an offset is used.

### 7.2.11.8.1.17 GRAPH\_SetGridFixedX()

#### Description

Fixes the grid in X-axis.

#### Prototype

```
unsigned GRAPH_SetGridFixedX(GRAPH_Handle hObj,  
                             unsigned      OnOff);
```

#### Parameters

Parameter	Description
<code>hObj</code>	Handle of GRAPH widget.
<code>OnOff</code>	1 if grid should be fixed in X-axis, 0 if not (default).

#### Return value

Previous value used.

#### Additional information

In some situations it can be useful to fix the grid in X-axis. A typical application would be a YT-graph, to which continuously new values are added and horizontal scrolling is possible. In this case it could be desirable to fix the grid in the background. For details about how to activate scrolling for a GRAPH widget, refer to `GRAPH_SetVSizeX()`.

### 7.2.11.8.1.18 GRAPH\_SetGridOffX()

#### Description

Adds an offset used to show the vertical grid lines. Similar to GRAPH\_SetGridOffY().

#### Prototype

```
unsigned GRAPH_SetGridOffX(GRAPH_Handle hObj,  
                           unsigned Value);
```

#### Parameters

Parameter	Description
<a href="#">hObj</a>	Handle of GRAPH widget.
<a href="#">Value</a>	Offset to be used.

#### Return value

Previous offset used to draw the vertical grid lines.

### 7.2.11.8.1.19 GRAPH\_SetGridOffY()

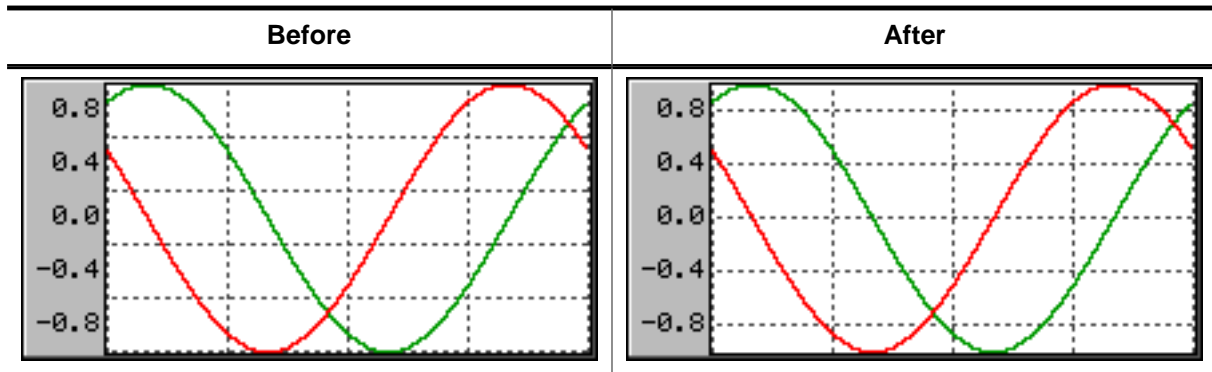

#### Description

Adds an offset used to show the horizontal grid lines.

#### Prototype

```
unsigned GRAPH_SetGridOffY(GRAPH_Handle hObj,
                           unsigned Value);
```

#### Parameters

Parameter	Description
<code>hObj</code>	Handle of GRAPH widget.
<code>Value</code>	Offset to be used.

#### Return value

Previous offset used to draw the horizontal grid lines.

#### Additional information

When rendering the grid the widget starts drawing the horizontal grid lines from the bottom of the data area and uses the current spacing. In case of a zero point in the middle of the Y-axis it could happen, that there is no grid line in the middle. In this case the grid can be shifted in Y-axis by adding an offset with this function. A positive value shifts the grid down and negative values shifts it up.

For details about how to set the grid spacing, refer to the functions `GRAPH_SetGridDistX()` and `GRAPH_SetGridDistY()`.

### 7.2.11.8.1.20 GRAPH\_SetGridVis()

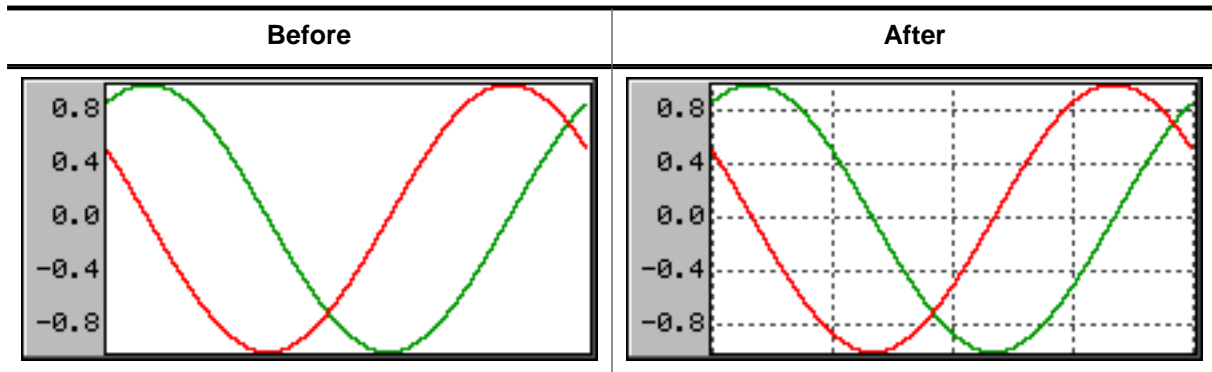

#### Description

Sets the visibility of the grid lines.

#### Prototype

```
unsigned GRAPH_SetGridVis(GRAPH_Handle hObj,
                          unsigned      OnOff);
```

#### Parameters

Parameter	Description
<code>hObj</code>	Handle of GRAPH widget.
<code>OnOff</code>	1 if the grid should be visible, 0 if not (default).

#### Return value

Previous value of the grid visibility.

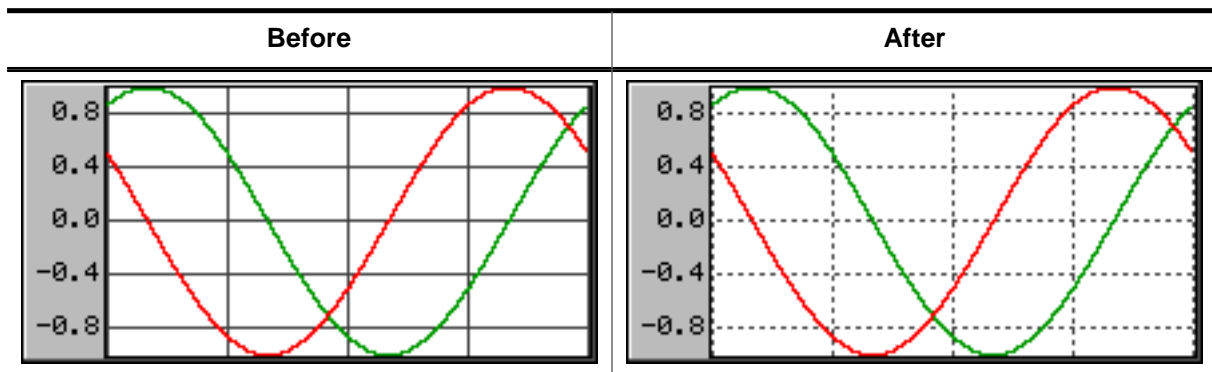
**7.2.11.8.1.21 GRAPH\_SetLineStyleH()****7.2.11.8.1.22 GRAPH\_SetLineStyleV()****Description**

These functions are used to set the line style used to draw the horizontal and vertical grid lines.

**Prototypes**

```
U8 GRAPH_SetLineStyleH(GRAPH_Handle hObj,
                       U8           LineStyle);
```

```
U8 GRAPH_SetLineStyleV(GRAPH_Handle hObj,
                       U8           LineStyle);
```

**Parameters**

Parameter	Description
<code>hObj</code>	Handle of GRAPH widget.
<code>LineStyle</code>	Line style to be used. For details about the supported line styles, refer to <code>GUI_SetLineStyle()</code> .
<code>Default</code>	is <code>GUI_LS_SOLID</code> .

**Return value**

Previous line style used to draw the horizontal/vertical grid lines.

**Additional information**

Note that using other styles than `GUI_LS_SOLID` will need more time to show the grid.

### 7.2.11.8.1.23 GRAPH\_SetScrollValue()

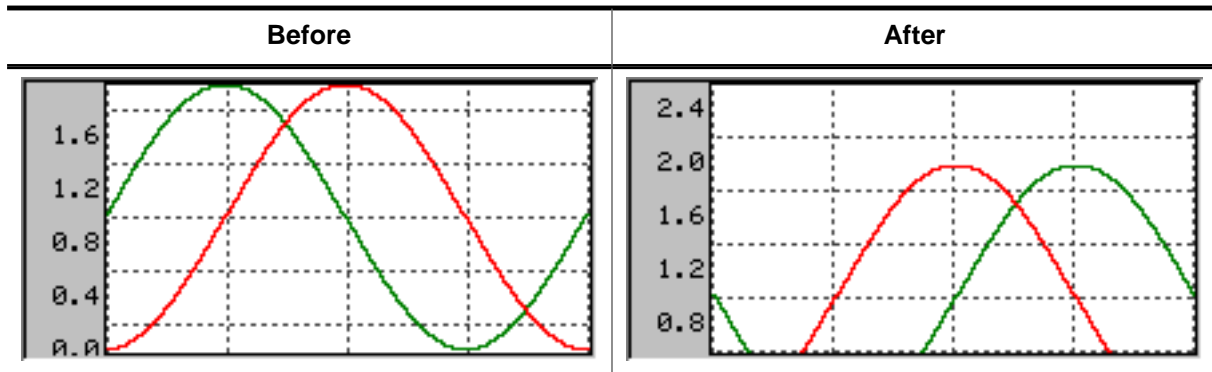

#### Description

Sets the scroll value for the given scroll bar.

#### Prototype

```
void GRAPH_SetScrollValue(GRAPH_Handle hObj,
                          U8           Coord,
                          U32          Value);
```

#### Parameters

Parameter	Description
<a href="#">hObj</a>	Handle of GRAPH widget.
<a href="#">Coord</a>	See table below.
<a href="#">Value</a>	Scroll value to set.

Permitted values for parameter <a href="#">Coord</a>	
GUI_COORD_X	Set the horizontal scroll value.
GUI_COORD_Y	Set the vertical scroll value.

#### 7.2.11.8.1.24 GRAPH\_SetUserData()

##### Description

Prototype explained at the beginning of the chapter as `<WIDGET>_SetUserData()` on page 1166.



### 7.2.11.8.1.25 GRAPH\_SetUserDraw()

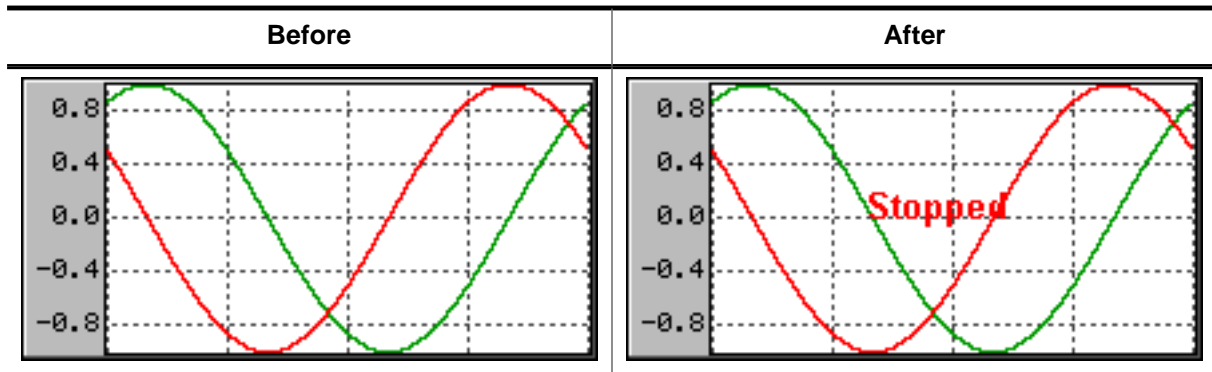

#### Description

Sets the user draw function. This function is called by the widget during the drawing process to give the application the possibility to draw user defined data.

#### Prototype

```
void GRAPH_SetUserDraw(GRAPH_Handle hObj,
                      void          (*pUserDraw)(WM_HWIN , int ));
```

#### Parameters

Parameter	Description
<code>hObj</code>	Handle of GRAPH widget
<code>pUserDraw</code>	Pointer to application function to be called by the widget during the drawing process.

#### Additional information

The user draw function is called at the beginning after filling the background of the data area and after drawing all GRAPH items like described at the beginning of the chapter. On the first call the clipping region is limited to the data area. On the last call it is limited to the complete GRAPH widget area except the effect frame.

#### Note

The user draw routine is called with a parameter `State`, available values for this parameter are listed under *GRAPH user draw stages* on page 1544.

#### Example

```
static void _UserDraw(WM_HWIN hWin, int Stage) {
    switch (Stage) {
        case GRAPH_DRAW_FIRST:
            //
            // Draw for example a user defined grid...
            //
            break;
        case GRAPH_DRAW_LAST:
            //
            // Draw for example a user defined scale or additional text...
            //
            break;
    }
}
static void _CreateGraph(void) {
    WM_HWIN hGraph;
    hGraph = GRAPH_CreateEx(10, 10, 216, 106, WM_HBKWIN, WM_CF_SHOW, 0, GUI_ID_GRAPH0);
```

```
GRAPH_SetUserDraw(hGraph, _UserDraw); // Enable user draw
...
}
```

## 7.2.11.8.1.26 GRAPH\_SetVSizeX()

## 7.2.11.8.1.27 GRAPH\_SetVSizeY()

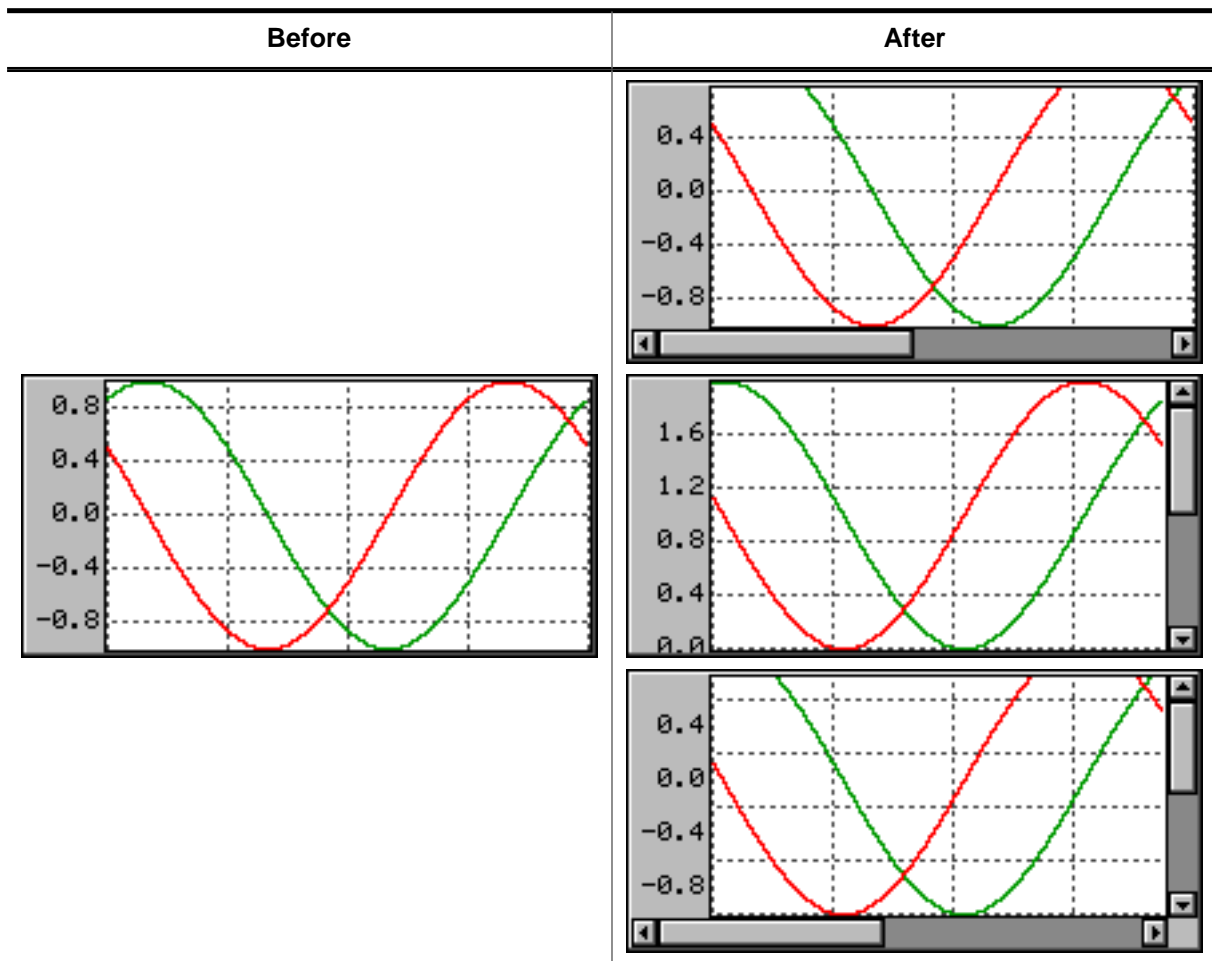

### Description

The functions set the virtual size in X and Y-axis.

### Prototypes

```
unsigned GRAPH_SetVSizeX(GRAPH_Handle hObj,
                        unsigned Value);
```

```
unsigned GRAPH_SetVSizeY(GRAPH_Handle hObj,
                        unsigned Value);
```

### Parameters

Parameter	Description
hObj	Handle of GRAPH widget.
Value	Virtual size in pixels in X or Y axis.

### Return value

Previous virtual size of the widgets data area in X or Y-axis.

### Additional information

If the widgets virtual size is bigger than the visible size of the data area, the widget automatically shows a scroll bar. If for example a data object, created by the function `GRAPH_DATA_YT_Create()`, contains more data than can be shown in the data area, the function `GRAPH_SetVSizeX()` can be used to enable scrolling. A function call like

`GRAPH_SetVSizeX(NumDataItems)` enables the horizontal scroll bar, provided that the number of data items is bigger than the X-size of the visible data area.

### 7.2.11.8.2 GRAPH\_DATA\_YT related routines

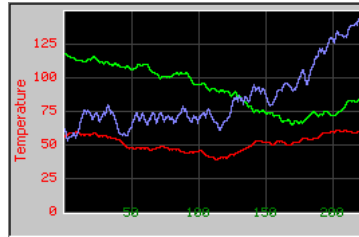

#### 7.2.11.8.2.1 GRAPH\_DATA\_YT\_AddValue()

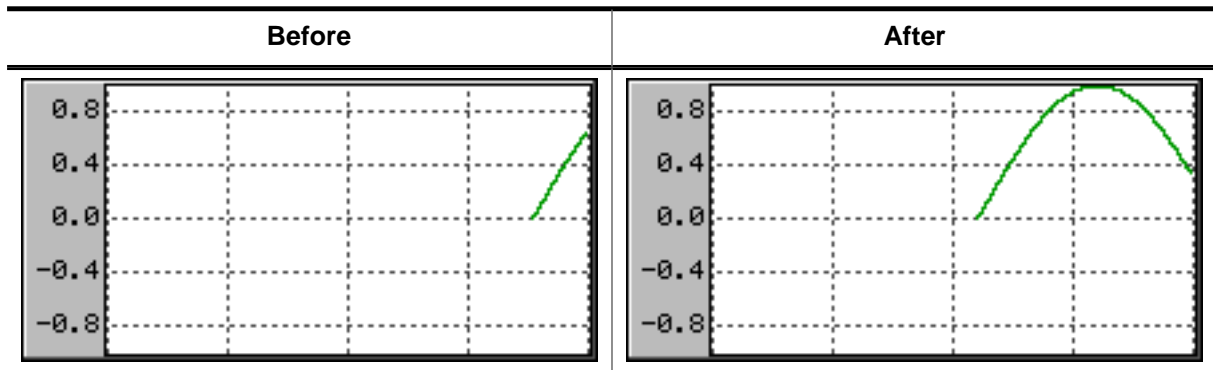

#### Description

Adds a new data item to a GRAPH\_DATA\_YT object.

#### Prototype

```
void GRAPH_DATA_YT_AddValue(GRAPH_DATA_Handle hDataObj,
                             I16 Value);
```

#### Parameters

Parameter	Description
<code>hDataObj</code>	Handle of data object.
<code>Value</code>	<code>Value</code> to be added to the data object.

#### Additional information

The given data value is added to the data object. If the data object is 'full', that means it contains as many data items as specified in parameter `MaxNumItems` during the creation, it first shifts the data items by one before adding the new value. So the first data item is shifted out when adding a data item to a 'full' object. The value `0x7FFF` can be used to handle invalid data values. These values are excluded when drawing the GRAPH. The following screenshot shows a graph with 2 gaps of invalid data:

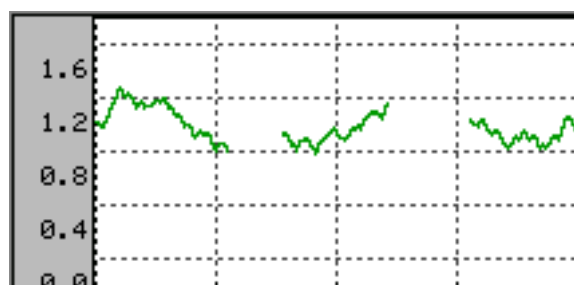

### 7.2.11.8.2.2 GRAPH\_DATA\_YT\_Clear()

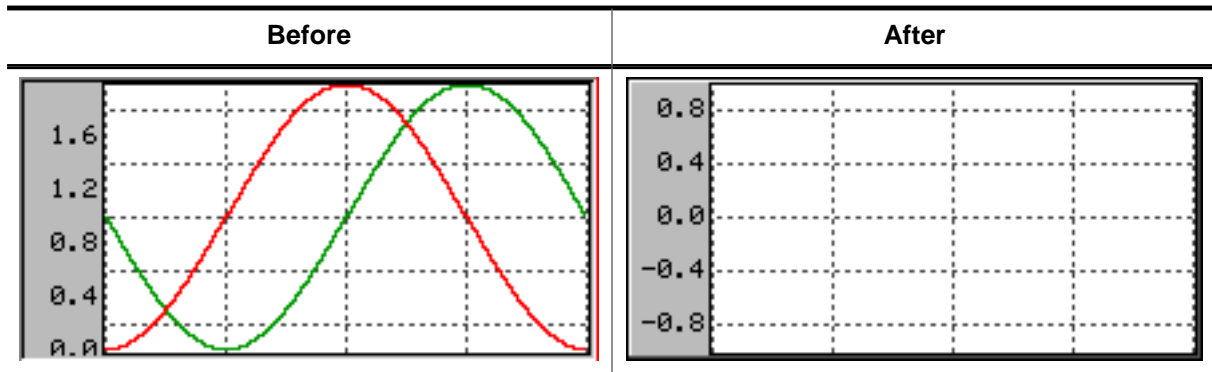

#### Description

Clears all data items of the data object.

#### Prototype

```
void GRAPH_DATA_YT_Clear(GRAPH_DATA_Handle hDataObj);
```

#### Parameters

Parameter	Description
<code>hDataObj</code>	Handle of data object.

### 7.2.11.8.2.3 GRAPH\_DATA\_YT\_Create()

#### Description

Creates a GRAPH\_DATA\_YT object. This kind of object requires for each point on the x-axis a value on the y-axis. Typically used for time related graphs.

#### Prototype

```
GRAPH_DATA_Handle GRAPH_DATA_YT_Create(      GUI_COLOR   Color,
                                             unsigned    MaxNumItems,
                                             const I16    * pItems,
                                             unsigned    NumItems);
```

#### Parameters

Parameter	Description
<code>Color</code>	<code>Color</code> to be used to draw the data.
<code>MaxNumItems</code>	Maximum number of data items.
<code>pItems</code>	Pointer to data to be added to the object. The pointer should point to an array of I16 values.
<code>NumItems</code>	Number of data items to be added.

#### Return value

Handle of data object if creation was successful, otherwise 0.

#### Additional information

The last data item is shown at the rightmost column of the data area. If a data object contains more data as can be shown in the data area of the GRAPH widget, the function GRAPH\_SetVSizeX() can be used to show a scroll bar which makes it possible to scroll through large data objects.

Once attached to a GRAPH widget a data object does not need to be deleted by the application. This is automatically done during the deletion of the GRAPH widget.

#### 7.2.11.8.2.4 GRAPH\_DATA\_YT\_Delete()

##### Description

Deletes the given data object.

##### Prototype

```
void GRAPH_DATA_YT_Delete(GRAPH_DATA_Handle hDataObj);
```

##### Parameters

Parameter	Description
<code>hDataObj</code>	Handle of data object to be deleted.

##### Additional information

When a GRAPH widget is deleted it deletes all currently attached data objects. So the application needs only to delete unattached data objects.



### 7.2.11.8.2.5 GRAPH\_DATA\_YT\_GetValue()

#### Description

Returns value for the given index.

#### Prototype

```
int GRAPH_DATA_YT_GetValue(GRAPH_DATA_Handle hDataObj,  
                           I16 * pValue,  
                           U32 Index);
```

#### Parameters

Parameter	Description
<a href="#">hDataObj</a>	Handle of data object.
<a href="#">pValue</a>	Pointer to a I16 variable.
<a href="#">Index</a>	<a href="#">Index</a> of data to be received.

#### Return value

0 on success.  
1 on error.

### 7.2.11.8.2.6 GRAPH\_DATA\_YT\_MirrorX()

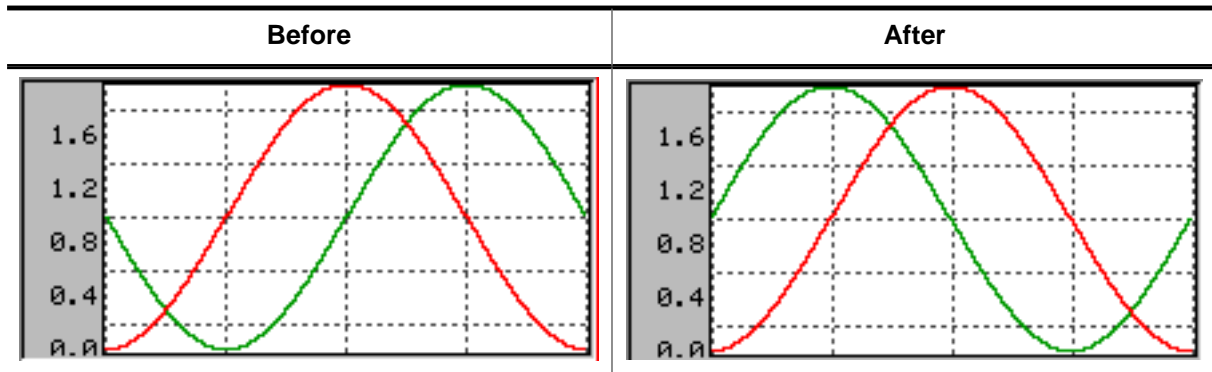

#### Description

Mirrors the x-axis of the widget.

#### Prototype

```
void GRAPH_DATA_YT_MirrorX(GRAPH_DATA_Handle hDataObj,
                           int OnOff);
```

#### Parameters

Parameter	Description
<code>hDataObj</code>	Handle of data object.
<code>OnOff</code>	1 for mirroring the x-axis, 0 for default view.

#### Additional information

Per default the data is drawn from the right to the left. After calling this function the data is drawn from the left to the right.

### 7.2.11.8.2.7 GRAPH\_DATA\_YT\_SetAlign()

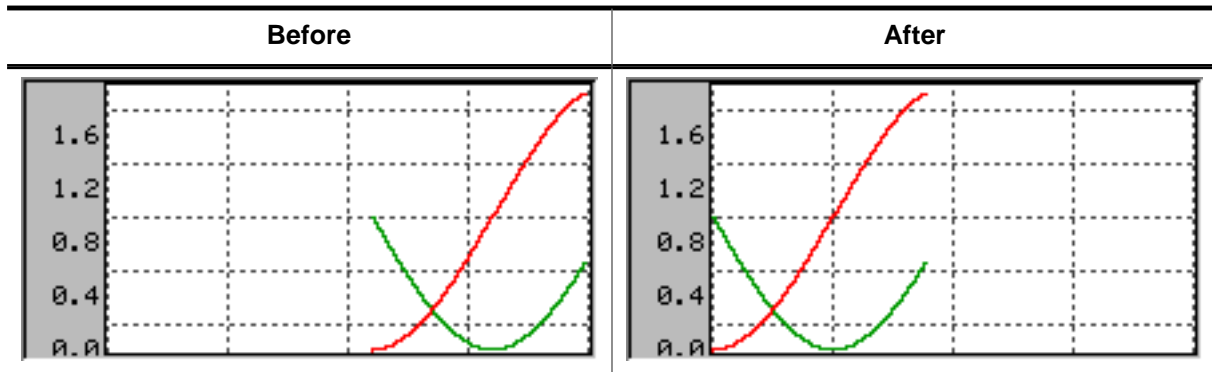

#### Description

Sets the alignment of the data.

#### Prototype

```
void GRAPH_DATA_YT_SetAlign(GRAPH_DATA_Handle hDataObj,
                             int Align);
```

#### Parameters

Parameter	Description
<code>hDataObj</code>	Handle of data object.
<code>Align</code>	Alignment of the data. See <i>GRAPH alignment flags</i> on page 1541.

### 7.2.11.8.2.8 GRAPH\_DATA\_YT\_SetColor()

#### Description

This function sets a color for the given data object.

#### Prototype

```
GUI_COLOR GRAPH_DATA_YT_SetColor(GRAPH_DATA_Handle hDataObj,  
                                  GUI_COLOR          Color);
```

#### Parameters

Parameter	Description
<code>hDataObj</code>	Handle to data object.
<code>Color</code>	<code>Color</code> to be set.

### 7.2.11.8.2.9 GRAPH\_DATA\_YT\_SetOffY()

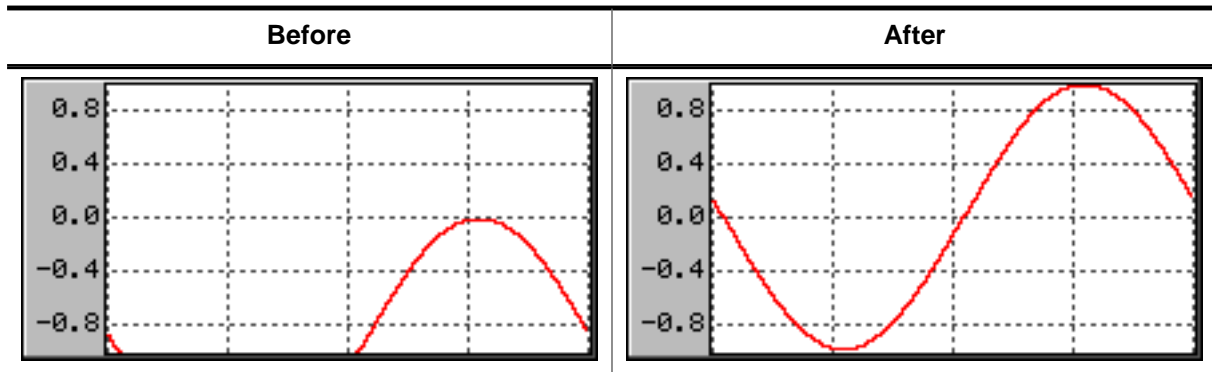

#### Description

Sets a vertical offset used to draw the object data.

#### Prototype

```
void GRAPH_DATA_YT_SetOffY(GRAPH_DATA_Handle hDataObj,
                           int Off);
```

#### Parameters

Parameter	Description
<code>hDataObj</code>	Handle of data object.
<code>Off</code>	Vertical offset which should be used to draw the data.

#### Additional information

The vertical range of data, which is shown by the data object, is the range (0) - (Y-size of data area - 1). In case of using a scroll bar the current scroll position is added to the range.

#### Example

If for example the visible data range should be -200 to -100 the data needs to be shifted in positive direction by 200 pixels:

```
GRAPH_DATA_YT_SetOffY(hDataObj, 200);
```

### 7.2.11.8.3 GRAPH\_DATA\_XY related routines

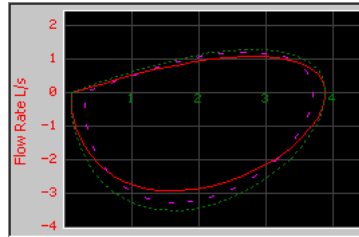

#### 7.2.11.8.3.1 GRAPH\_DATA\_XY\_AddPoint()

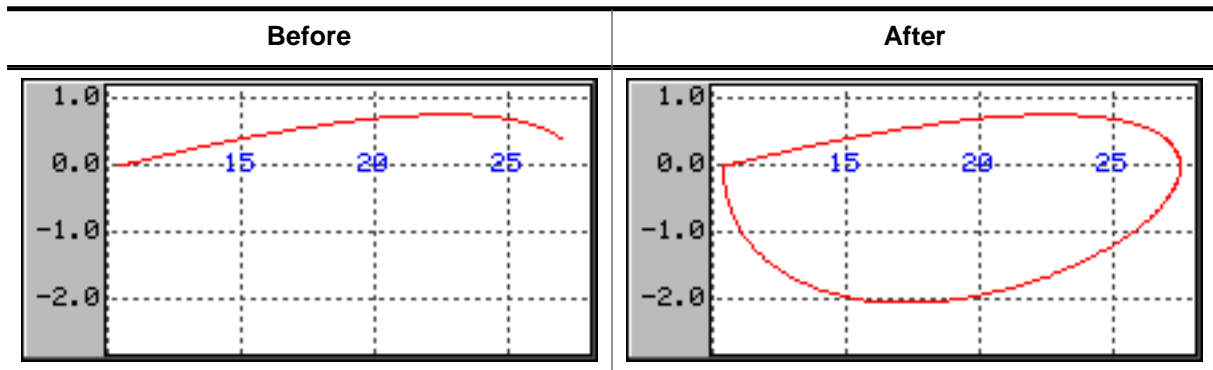

#### Description

Adds a new data item to a GRAPH\_DATA\_XY object.

#### Prototype

```
void GRAPH_DATA_XY_AddPoint(GRAPH_DATA_Handle hDataObj,
                             GUI_POINT * pPoint);
```

#### Parameters

Parameter	Description
<code>hDataObj</code>	Handle of data object.
<code>pPoint</code>	Pointer to a GUI_POINT structure to be added to the data object.

#### Additional information

The given point is added to the data object. If the data object is 'full', that means it contains as many points as specified in parameter `MaxNumItems` during the creation, it first shifts the data items by one before adding the new point. So the first point is shifted out when adding a new point to a 'full' object.

### 7.2.11.8.3.2 GRAPH\_DATA\_XY\_Clear()

#### Description

Clears all data items of the data object.

#### Prototype

```
void GRAPH_DATA_XY_Clear(GRAPH_DATA_Handle hDataObj);
```

#### Parameters

Parameter	Description
<a href="#">hDataObj</a>	Handle of data object.

### 7.2.11.8.3.3 GRAPH\_DATA\_XY\_Create()

#### Description

Creates a GRAPH\_DATA\_XY object. This kind of object is able to store any pairs of values which will be connected by adding order.

#### Prototype

```
GRAPH_DATA_Handle GRAPH_DATA_XY_Create(      GUI_COLOR    Color,
                                             unsigned      MaxNumItems,
                                             const GUI_POINT * pItems,
                                             unsigned      NumItems);
```

#### Parameters

Parameter	Description
Color	Color to be used to draw the data.
MaxNumItems	Maximum number of points.
pData	Pointer to data to be added to the object. The pointer should point to a GUI_POINT array.
NumItems	Number of points to be added.

#### Return value

Handle of data object if creation was successful, otherwise 0.

#### Additional information

Once attached to a GRAPH widget a data object does not need to be deleted by the application. This is automatically done during the deletion of the GRAPH widget.



#### 7.2.11.8.3.4 GRAPH\_DATA\_XY\_Delete()

##### Description

Deletes the given data object.

##### Prototype

```
void GRAPH_DATA_XY_Delete(GRAPH_DATA_Handle hDataObj);
```

##### Parameters

Parameter	Description
<code>hDataObj</code>	Data object to be deleted.

##### Additional information

When a GRAPH widget is deleted it deletes all currently attached data objects. So the application needs only to delete unattached data objects.

### 7.2.11.8.3.5 GRAPH\_DATA\_XY\_GetLineVis()

#### Description

Returns if the line of the data object is visible.

#### Prototype

```
unsigned GRAPH_DATA_XY_GetLineVis(GRAPH_DATA_Handle hDataObj);
```

#### Parameters

Parameter	Description
<a href="#">hDataObj</a>	Handle of data object.

#### Return value

- 0 Line is not visible.
- 1 Line is visible.

### 7.2.11.8.3.6 GRAPH\_DATA\_XY\_GetPoint()

#### Description

Returns a point for the given index.

#### Prototype

```
int GRAPH_DATA_XY_GetPoint(GRAPH_DATA_Handle hDataObj,  
                           GUI_POINT * pPoint,  
                           U32 Index);
```

#### Parameters

Parameter	Description
<a href="#">hDataObj</a>	Handle of data object.
<a href="#">pPoint</a>	Pointer to a GUI_POINT structure.
<a href="#">Index</a>	<a href="#">Index</a> of data to be received.

#### Return value

0 on success.  
1 on error.

### 7.2.11.8.3.7 GRAPH\_DATA\_XY\_GetPointVis()

#### Description

Returns if the points of a data object have been made visible.

#### Prototype

```
unsigned GRAPH_DATA_XY_GetPointVis(GRAPH_DATA_Handle hDataObj);
```

#### Parameters

Parameter	Description
<a href="#">hDataObj</a>	Handle of data object.

#### Return value

- 0 Points are not made visible.
- 1 Points are made visible.

### 7.2.11.8.3.8 GRAPH\_DATA\_XY\_SetColor()

#### Description

This function sets a color for the given data object.

#### Prototype

```
GUI_COLOR GRAPH_DATA_XY_SetColor(GRAPH_DATA_Handle hDataObj,  
                                  GUI_COLOR          Color);
```

#### Parameters

Parameter	Description
<code>hDataObj</code>	Handle of data object.
<code>Color</code>	<code>Color</code> to be set.

### 7.2.11.8.3.9 GRAPH\_DATA\_XY\_SetLineStyle()

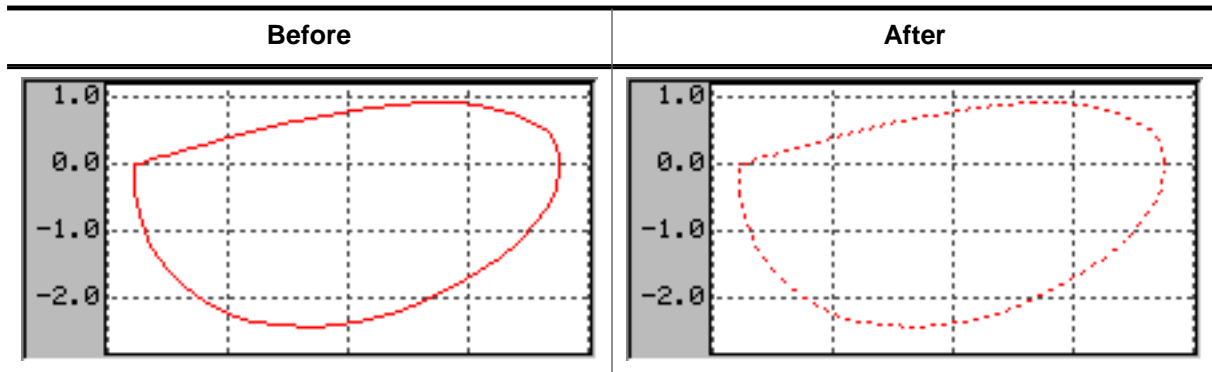

#### Description

Sets the line style used to draw the polyline.

#### Prototype

```
void GRAPH_DATA_XY_SetLineStyle(GRAPH_DATA_Handle hDataObj,
                                U8 LineStyle);
```

#### Parameters

Parameter	Description
<code>hDataObj</code>	Handle of data object.
<code>LineStyle</code>	New line style to be used. For details about the supported line styles refer to <code>GUI_SetLineStyle()</code> .

#### Limitations

Note that only curves with line style `GUI_LS_SOLID` (default) can be drawn with a pen size > 1.

### 7.2.11.8.3.10 GRAPH\_DATA\_XY\_SetLineVis()

#### Description

Sets the visibility of the data object's line.

#### Prototype

```
unsigned GRAPH_DATA_XY_SetLineVis(GRAPH_DATA_Handle hDataObj,  
                                  unsigned          OnOff);
```

#### Parameters

Parameter	Description
<code>hDataObj</code>	Handle of data object.
<code>OnOff</code>	1 to make the line visible, 0 to clear visibility flag.

#### Return value

- 0 If line was not previously visible.
- 1 If line was previously visible.

## 7.2.11.8.3.11 GRAPH\_DATA\_XY\_SetOffX()

## 7.2.11.8.3.12 GRAPH\_DATA\_XY\_SetOffY()

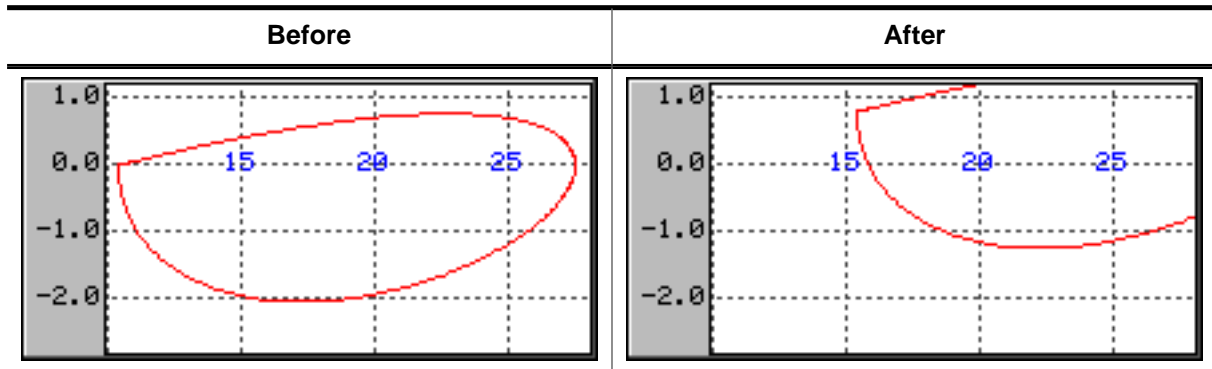

### Description

Sets a vertical or horizontal offset used to draw the polyline.

### Prototypes

```
void GRAPH_DATA_XY_SetOffX(GRAPH_DATA_Handle hDataObj,
                           int Off);
```

```
void GRAPH_DATA_XY_SetOffY(GRAPH_DATA_Handle hDataObj,
                           int Off);
```

### Parameters

Parameter	Description
<code>hDataObj</code>	Handle of data object.
<code>Off</code>	Horizontal/vertical offset which should be used to draw the polyline.

### Additional information

The range of data shown by the data object is (0, 0) - (X-size of data area - 1, Y-size of data area - 1). In case of using scroll bars the current scroll position is added to the respective range. To make other ranges of data visible this function should be used to set an offset, so that the data is in the visible area.

### Example

If for example the visible data range should be (100, -1200) - (200, -1100) the following offsets need to be used:

```
GRAPH_DATA_XY_SetOffX(hDataObj, -100);
GRAPH_DATA_XY_SetOffY(hDataObj, 1200);
```



### 7.2.11.8.3.13 GRAPH\_DATA\_XY\_SetOwnerDraw()

#### Description

Sets the owner callback function. This function is called by the widget during the drawing process to give the application the possibility to draw additional items on top of the widget.

#### Prototype

```
void GRAPH_DATA_XY_SetOwnerDraw(GRAPH_DATA_Handle      hDataObj,
                                WIDGET_DRAW_ITEM_FUNC * pfOwnerDraw);
```

#### Parameters

Parameter	Description
<code>hDataObj</code>	Handle of data object.
<code>Color</code>	<code>Color</code> to be set.

#### Supported commands

- WIDGET\_ITEM\_DRAW

#### Additional information

The owner draw function is called after background, scales and grid lines are drawn.

#### Example

The following code snippet shows an example of an user draw function:

```
static int _cbData(const WIDGET_ITEM_DRAW_INFO * pDrawItemInfo) {
    switch (pDrawItemInfo->Cmd) {
        case WIDGET_ITEM_DRAW:
            GUI_DrawRect(pDrawItemInfo->x0 - 3, pDrawItemInfo->y0 - 3,
                        pDrawItemInfo->x0 + 3, pDrawItemInfo->y0 + 3);
            break;
    }
    return 0;
}

void MainTask(void) {
    WM_HWIN      hGraph;
    GRAPH_DATA_Handle hData;
    GUI_Init();
    hGraph = GRAPH_CreateEx (140, 100, 171, 131, 0, WM_CF_SHOW, 0, GUI_ID_GRAPH0);
    hData = GRAPH_DATA_XY_Create(USER_DEFINED_COLOR, 126, 0, 0);
    GRAPH_DATA_XY_SetOwnerDraw(hData, _cbData);
}
```

### 7.2.11.8.3.14 GRAPH\_DATA\_XY\_SetPenSize()

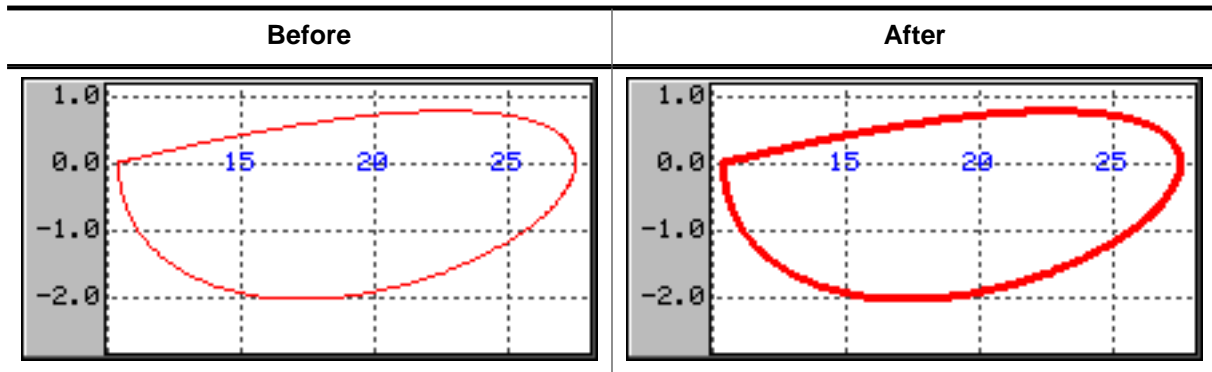

#### Description

Sets the pen size used to draw the polyline.

#### Prototype

```
void GRAPH_DATA_XY_SetPenSize(GRAPH_DATA_Handle hDataObj,
                              U8 PenSize);
```

#### Parameters

Parameter	Description
<code>hDataObj</code>	Handle of data object.
<code>PenSize</code>	Pen size which should be used to draw the polyline.

#### Limitations

Note that only curves with line style `GUI_LS_SOLID` (default) can be drawn with a pen size > 1.

### 7.2.11.8.3.15 GRAPH\_DATA\_XY\_SetPointVis()

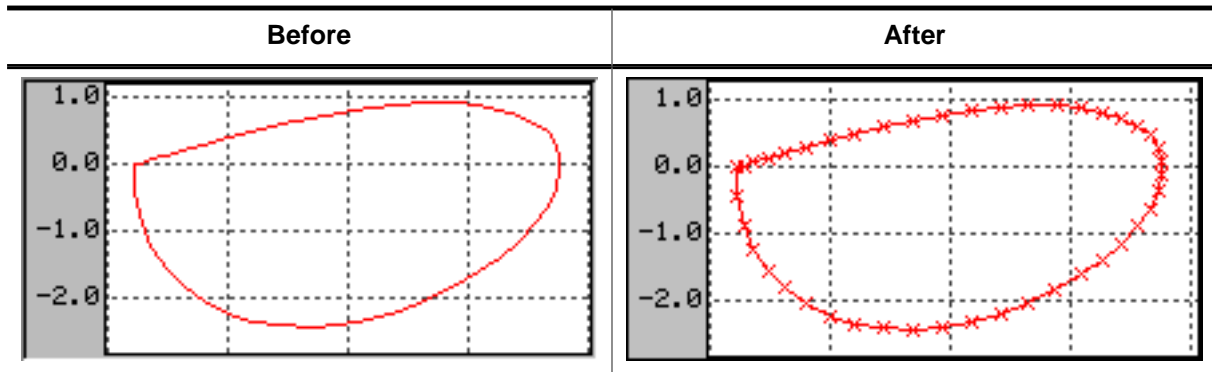

#### Description

Makes all points of a data object visible. Each point has a small marking.

#### Prototype

```
unsigned GRAPH_DATA_XY_SetPointVis(GRAPH_DATA_Handle hDataObj,
                                   unsigned           OnOff);
```

#### Parameters

Parameter	Description
hDataObj	Handle of data object.
OnOff	1 to make all points visible, 0 to just show the line.

#### Return value

- 0 If points were not previously visible.
- 1 If points were previously visible.

### 7.2.11.8.4 Scale related routines

The GRAPH widget supports horizontal and vertical scales for labeling purpose. The following describes the available functions for using scales.

#### 7.2.11.8.4.1 GRAPH\_SCALE\_Create()

##### Description

Creates a GRAPH\_SCALE object.

##### Prototype

```
GRAPH_SCALE_Handle GRAPH_SCALE_Create(int      Pos,
                                     int      TextAlign,
                                     unsigned Flags,
                                     unsigned TickDist);
```

##### Parameters

Parameter	Description
<a href="#">Pos</a>	Position relative to the left/top edge of the GRAPH widget.
<a href="#">TextAlign</a>	Text alignment used to draw the numbers. See <i>Text alignment flags</i> on page 286.
<a href="#">Flags</a>	See <i>SCALE create flags</i> on page 1545.
<a href="#">TickDist</a>	Distance from one tick mark to the next.

##### Return value

Handle of the scale object if creation was successful, otherwise 0.

##### Additional information

A horizontal scale object starts labeling from the bottom edge of the data area to the top and a vertical scale object from the left edge (horizontal scale) to the right, where the first position is the zero point. The parameter [TickDist](#) specifies the distance between the numbers.

The parameter [Pos](#) specifies in case of a horizontal scale the vertical distance in pixels from the top edge of the GRAPH widget to the scale text. In case of a vertical scale the parameter specifies the horizontal distance from the left edge of the GRAPH widget to the horizontal text position. Note that the actual text position also depends on the text alignment specified with parameter [TextAlign](#).

The scale object draws a number for each position which is within the data area. In case of a horizontal scale there is one exception: If the first position is 0 no number is drawn at this position.

Once attached to a GRAPH widget a scale object does not need to be deleted by the application. This is automatically done during the deletion of the GRAPH widget.

#### 7.2.11.8.4.2 GRAPH\_SCALE\_Delete()

##### Description

Deletes the given scale object.

##### Prototype

```
void GRAPH_SCALE_Delete(GRAPH_SCALE_Handle hScaleObj);
```

##### Parameters

Parameter	Description
<a href="#">hScaleObj</a>	Handle of scale object to be deleted.

##### Additional information

When a GRAPH widget is deleted it deletes all currently attached scale objects. So the application needs only to delete unattached scale objects.

### 7.2.11.8.4.3 GRAPH\_SCALE\_SetFactor()

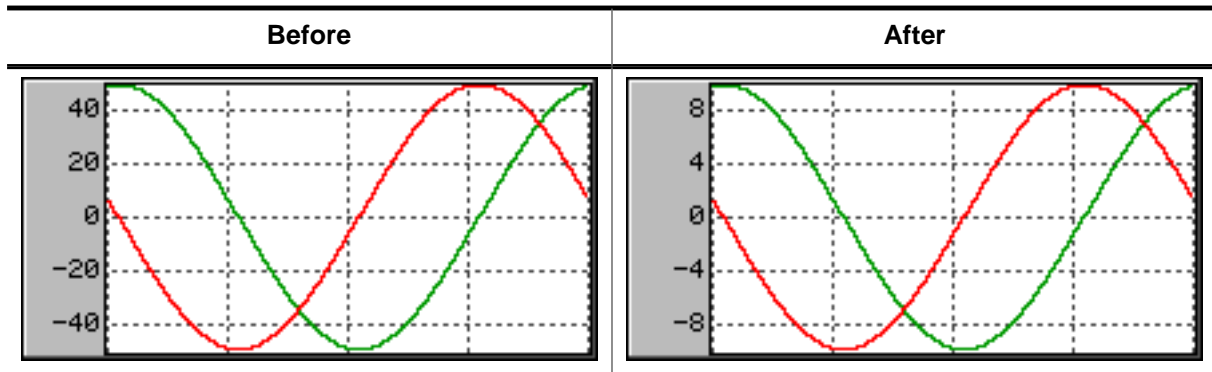

#### Description

Sets a factor used to calculate the numbers to be drawn.

#### Prototype

```
float GRAPH_SCALE_SetFactor(GRAPH_SCALE_Handle hScaleObj,
                           float Factor);
```

#### Parameters

Parameter	Description
<code>hScaleObj</code>	Handle of scale object.
<code>Factor</code>	<code>Factor</code> to be used to calculate the number.

#### Return value

Old factor used to calculate the numbers.

#### Additional information

Without using a factor the unit of the scale object is 'pixel'. So the given factor should convert the pixel value to the desired unit.

#### 7.2.11.8.4.4 GRAPH\_SCALE\_SetFont()

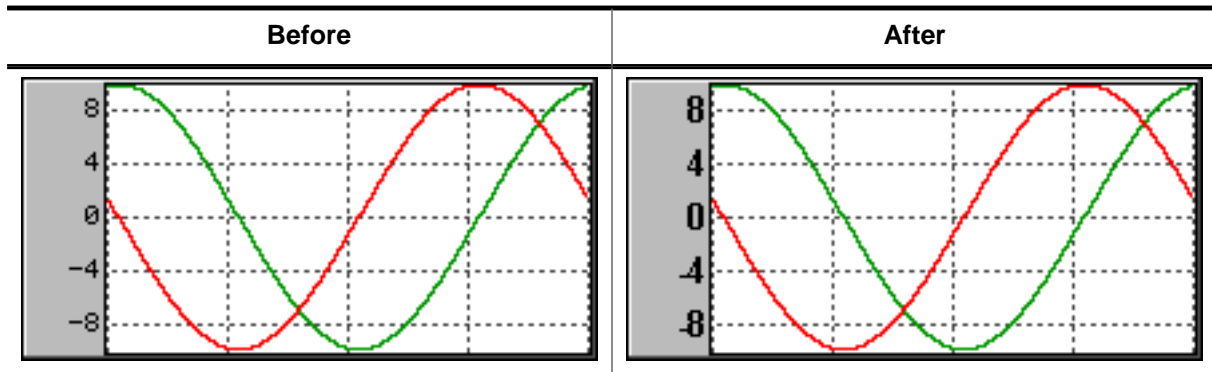

### Description

Sets the font used to draw the scale numbers.

### Prototype

```
GUI_FONT *GRAPH_SCALE_SetFont(    GRAPH_SCALE_Handle  hScaleObj,
                                const GUI_FONT          * pFont);
```

### Parameters

Parameter	Description
<code>hScaleObj</code>	Handle of scale object.
<code>pFont</code>	Font to be used.

### Return value

Previous used font used to draw the numbers.

### 7.2.11.8.4.5 GRAPH\_SCALE\_SetNumDecs()

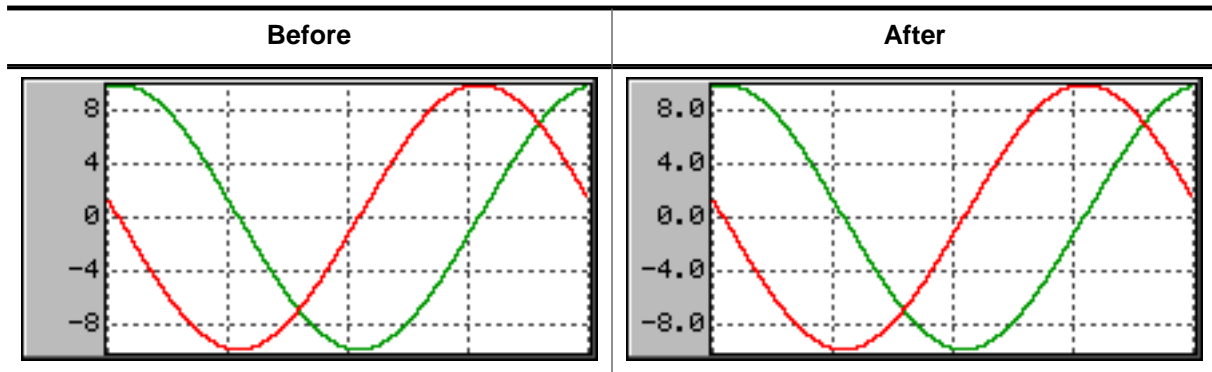

#### Description

Sets the number of post decimal positions to be shown.

#### Prototype

```
int GRAPH_SCALE_SetNumDecs(GRAPH_SCALE_Handle hScaleObj,
                           int NumDecs);
```

#### Parameters

Parameter	Description
<code>hScaleObj</code>	Handle of scale object.
<code>NumDecs</code>	Number of post decimal positions.

#### Return value

Previous number of post decimal positions.



#### 7.2.11.8.4.6 GRAPH\_SCALE\_SetOff()

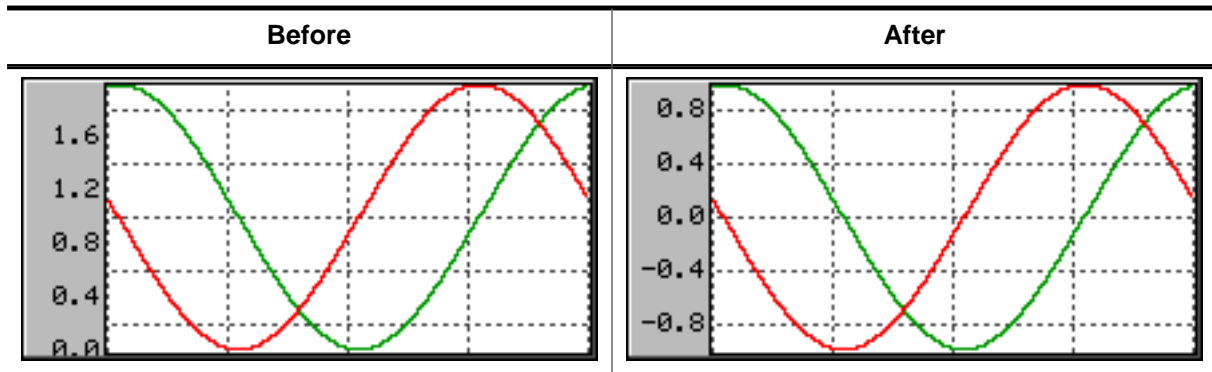

### Description

Sets an offset used to 'shift' the scale object in positive or negative direction.

### Prototype

```
int GRAPH_SCALE_SetOff(GRAPH_SCALE_Handle hScaleObj,
                      int Off);
```

### Parameters

Parameter	Description
<code>hScaleObj</code>	Handle of scale object.
<code>Off</code>	Offset used for drawing the scale.

### Return value

Previous used offset.

### Additional information

As described under the function `GRAPH_SCALE_Create()` a horizontal scale object starts labeling from the bottom edge of the data area to the top and a vertical scale object from the left edge (horizontal scale) to the right, where the first position is the zero point. In many situations it is not desirable, that the first position is the zero point. If the scale should be 'shifted' in positive direction, a positive offset should be added, for negative direction a negative value.

### 7.2.11.8.4.7 GRAPH\_SCALE\_SetPos()

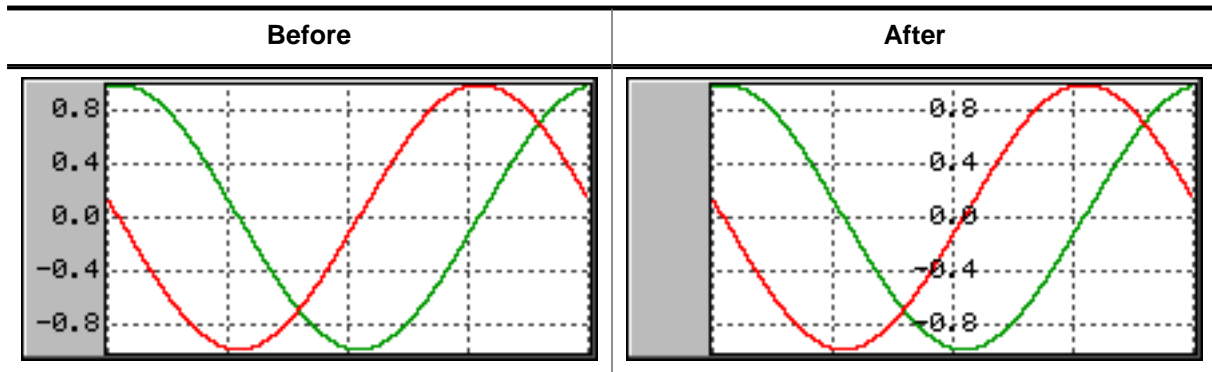

#### Description

Sets the position for showing the scale object within the GRAPH widget.

#### Prototype

```
int GRAPH_SCALE_SetPos(GRAPH_SCALE_Handle hScaleObj,
                       int Pos);
```

#### Parameters

Parameter	Description
<code>hScaleObj</code>	Handle of scale object.
<code>Pos</code>	Position, at which the scale should be shown.

#### Return value

Previous position of the scale object.

#### Additional information

The parameter `Pos` specifies in case of a horizontal scale the vertical distance in pixels from the top edge of the GRAPH widget to the scale text. In case of a vertical scale the parameter specifies the horizontal distance from the left edge of the GRAPH widget to the horizontal text position. Note that the actual text position also depends on the text alignment of the scale object.

### 7.2.11.8.4.8 GRAPH\_SCALE\_SetTextColor()

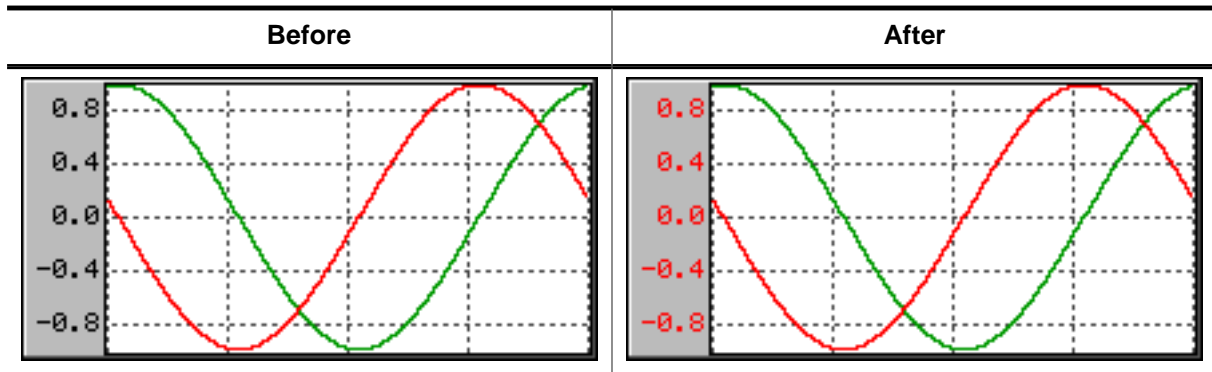

#### Description

Sets the text color used to draw the numbers.

#### Prototype

```
GUI_COLOR GRAPH_SCALE_SetTextColor(GRAPH_SCALE_Handle hScaleObj,
                                   GUI_COLOR          Color);
```

#### Parameters

Parameter	Description
<code>hScaleObj</code>	Handle of scale object.
<code>Color</code>	<code>Color</code> to be used to show the numbers.

#### Return value

Previous color used to show the numbers.

### 7.2.11.8.4.9 GRAPH\_SCALE\_SetTickDist()

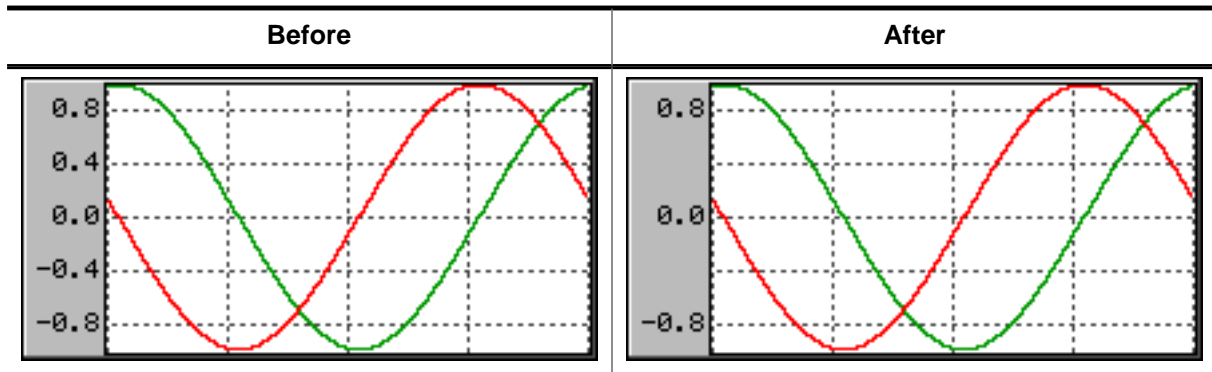

#### Description

Sets the distance from one number to the next.

#### Prototype

```
unsigned GRAPH_SCALE_SetTickDist(GRAPH_SCALE_Handle hScaleObj,
                                unsigned Value);
```

#### Parameters

Parameter	Description
<code>hScaleObj</code>	Handle of scale object.
<code>Dist</code>	Distance in pixels between the numbers.

#### Return value

Previous distance between the numbers.

## 7.2.11.8.5 Defines

### 7.2.11.8.5.1 GRAPH alignment flags

#### Description

Flags that define the alignment of the data of a graph.

#### Definition

```
#define GRAPH_ALIGN_RIGHT    (0 << 0)
#define GRAPH_ALIGN_LEFT    (1 << 0)
```

#### Symbols

Definition	Description
<a href="#">GRAPH_ALIGN_RIGHT</a>	The data is aligned at the right edge (default).
<a href="#">GRAPH_ALIGN_LEFT</a>	The data is aligned at the left edge.

### 7.2.11.8.5.2 GRAPH color indexes

#### Description

Color indexes used by the GRAPH widget.

#### Definition

```
#define GRAPH_CI_BK          0
#define GRAPH_CI_BORDER    1
#define GRAPH_CI_FRAME     2
#define GRAPH_CI_GRID      3
```

#### Symbols

Definition	Description
<a href="#">GRAPH_CI_BK</a>	Background color.
<a href="#">GRAPH_CI_BORDER</a>	Color of the border area.
<a href="#">GRAPH_CI_FRAME</a>	Color of the thin frame line.
<a href="#">GRAPH_CI_GRID</a>	Color of the grid.

### 7.2.11.8.5.3 GRAPH create flags

#### Description

Create flags used for GRAPH objects.

#### Definition

```
#define GRAPH_CF_GRID_FIXED_X      (1 << 0)
#define GRAPH_CF_AVOID_SCROLLBAR_H (1 << 1)
#define GRAPH_CF_AVOID_SCROLLBAR_V (1 << 2)
```

#### Symbols

Definition	Description
<a href="#">GRAPH_CF_GRID_FIXED_X</a>	This flag 'fixes' the grid in X-axis. That means if horizontal scrolling is used, the grid remains in its position.
<a href="#">GRAPH_CF_AVOID_SCROLLBAR_H</a>	Automatic use of a horizontal scrollbar is disabled. (Default).
<a href="#">GRAPH_CF_AVOID_SCROLLBAR_V</a>	Automatic use of a vertical scrollbar is disabled. (Default).

### 7.2.11.8.5.4 GRAPH user draw stages

#### Description

Stages sent to a user draw routine with the `Stage` parameter. For more information, refer to `GRAPH_SetUserDraw()`.

#### Definition

```
#define GRAPH_DRAW_FIRST           0
#define GRAPH_DRAW_AFTER_BORDER   1
#define GRAPH_DRAW_LAST           2
```

#### Symbols

Definition	Description
<code>GRAPH_DRAW_FIRST</code>	Gives the application the possibility to perform drawing operations at the beginning of the drawing process.
<code>GRAPH_DRAW_AFTER_BORDER</code>	Gives the application the possibility to perform drawing operations after the border was drawn.
<code>GRAPH_DRAW_LAST</code>	Performs final drawing operations.



### 7.2.11.8.5.5 SCALE create flags

#### Description

Create flags used for scale objects.

#### Definition

```
#define GRAPH_SCALE_CF_HORIZONTAL (0 << 0)
#define GRAPH_SCALE_CF_VERTICAL (1 << 0)
```

#### Symbols

Definition	Description
<a href="#">GRAPH_SCALE_CF_HORIZONTAL</a>	Creates a horizontal scale object.
<a href="#">GRAPH_SCALE_CF_VERTICAL</a>	Creates a vertical scale object.

### 7.2.11.9 Examples

The `Sample` folder contains the following examples which show how the widget can be used:

- `WIDGET_GraphXY.c`
- `WIDGET_GraphYT.c`

Note that several other examples also make use of this widget and may also be helpful to get familiar with the widget.

#### Screenshot of `WIDGET_GraphXY.c`:

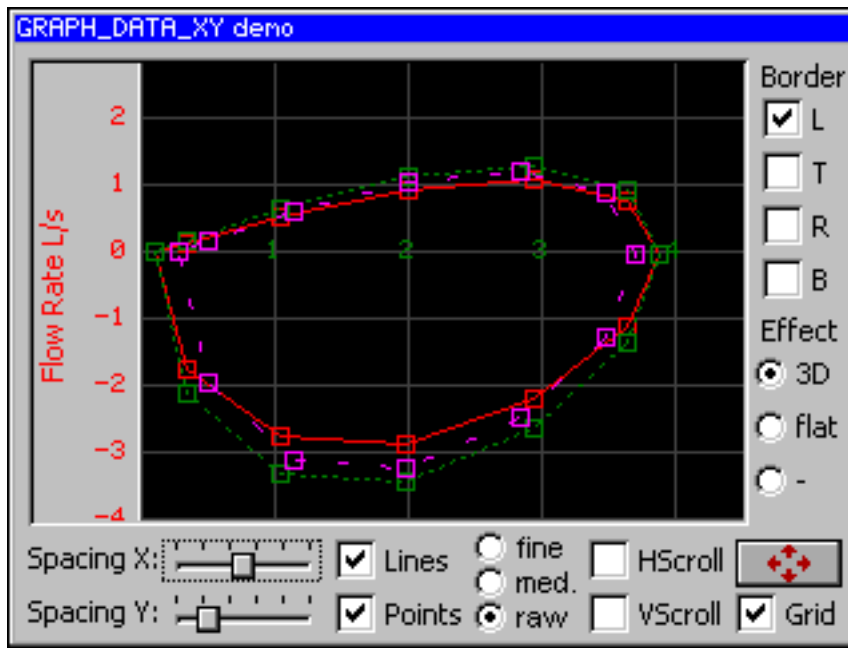

#### Screenshot of `WIDGET_GraphYT.c`:

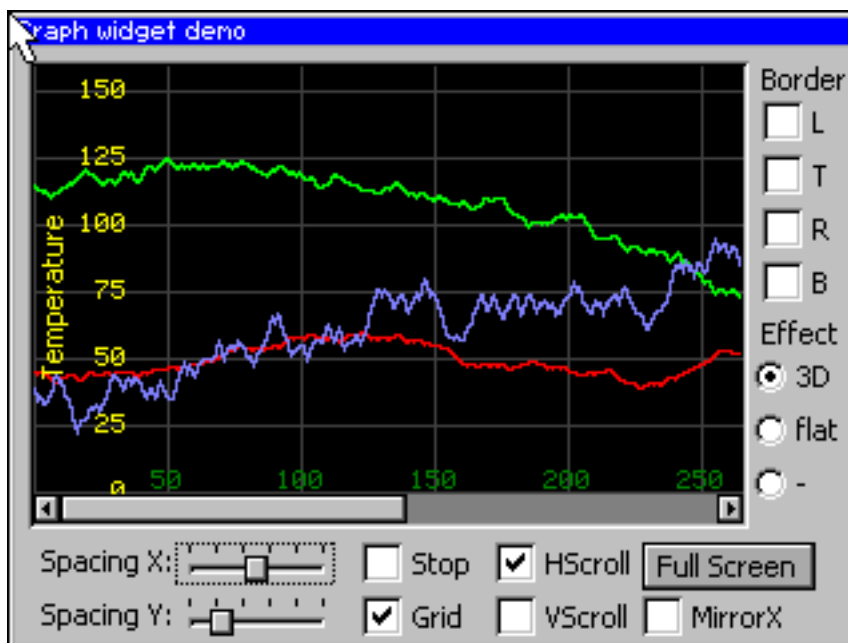

## 7.2.12 HEADER: Header widget

HEADER widgets are used to label columns of a table:



### Note

All HEADER-related routines are located in the file(s) `HEADER*.c`, `HEADER.h`. All identifiers are prefixed `HEADER`.

If a pointer input device (PID) is used, the width of the HEADER items can be managed by dragging the dividers by the PID.

### Behavior with mouse

If mouse support is enabled, the cursor is on and the PID is moved nearby a divider the cursor will change to signal, that the divider can be dragged at the current position.

### Behavior with touch screen

If the widget is pressed nearby a divider and the cursor is on the cursor will change to signal, that the divider can now be dragged.

### Screenshot of drag-able divider



### Predefined cursors

There are 2 predefined cursors as shown below:

GUI_CursorHeaderM (default)	GUI_CursorHeaderMI

You can also create and use your own cursors when using a HEADER widget as described later in this chapter.

### Skinning...



...is available for this widget. The screenshot above shows the widget using the default skin. Details can be found in the chapter *Skinning* on page 2800.

### Note

This widget uses skinning. To change the look it is recommended to use the function `<WIDGET>_SetSkinFlexProps()`. Other functions to change the look might work only with the classic skin.

## 7.2.12.1 Configuration options

Type	Macro	Default	Description
N	HEADER_BKCOLOR_DEFAULT	0xA6AAAA	Default value of background color.

Type	Macro	Default	Description
S	HEADER_CURSOR_DEFAULT	&GUI_CursorHeaderM	Default cursor.
S	HEADER_FONT_DEFAULT	&GUI_Font13_1	Default font.
N	HEADER_BORDER_H_DEFAULT	2	Horizontal space between text and border.
N	HEADER_BORDER_V_DEFAULT	0	Vertical space between text and border.
B	HEADER_SUPPORT_DRAG	1	Enable/disable dragging support.
N	HEADER_TEXTCOLOR_DEFAULT	GUI_BLACK	Default value of text color.

### 7.2.12.2 Notification codes

The following events are sent from a HEADER widget to its parent window as part of a WM\_NOTIFY\_PARENT message:

Message	Description
WM_NOTIFICATION_CLICKED	Widget has been clicked.
WM_NOTIFICATION_RELEASED	Widget has been released.
WM_NOTIFICATION_MOVED_OUT	Widget has been clicked and pointer has been moved out of the widget without releasing.

### 7.2.12.3 Keyboard reaction

The widget can not gain the input focus and does not react on keyboard input.

### 7.2.12.4 HEADER API

The table below lists the available emWin HEADER-related routines in alphabetical order. Detailed descriptions of the routines follow.

Routine	Description
<a href="#">HEADER_AddItem()</a>	Adds an item to an already existing HEADER widget.
<a href="#">HEADER_Create()</a>	Creates a HEADER widget. (Obsolete)
<a href="#">HEADER_CreateAttached()</a>	Creates a HEADER widget attached to a window.
<a href="#">HEADER_CreateEx()</a>	Creates a HEADER widget.
<a href="#">HEADER_CreateIndirect()</a>	Creates a HEADER widget from a resource table entry.
<a href="#">HEADER_CreateUser()</a>	Creates a HEADER widget using extra bytes as user data.
<a href="#">HEADER_DeleteItem()</a>	Deletes an item from the HEADER widget.
<a href="#">HEADER_GetBkColor()</a>	Returns the background color of the given HEADER widget.
<a href="#">HEADER_GetBorderH()</a>	Returns the horizontal border size of the HEADER.
<a href="#">HEADER_GetBorderV()</a>	Returns the vertical border size of the HEADER.
<a href="#">HEADER_GetColumnFromPos()</a>	Returns the index of the column matching the given X-position.
<a href="#">HEADER_GetDefaultBkColor()</a>	Returns the default background color used when creating a HEADER widget.
<a href="#">HEADER_GetDefaultBorderH()</a>	Returns the value used for the horizontal spacing when creating a HEADER widget.

Routine	Description
<code>HEADER_GetDefaultBorderV()</code>	Returns the value used for the vertical spacing when creating a HEADER widget.
<code>HEADER_GetDefaultCursor()</code>	Returns a pointer to the cursor displayed when dragging the width of an item.
<code>HEADER_GetDefaultFont()</code>	Returns a pointer to the default font used when creating a HEADER widget.
<code>HEADER_GetDefaultTextColor()</code>	Returns the default text color used when creating a HEADER widget.
<code>HEADER_GetFont()</code>	Returns the font of the given HEADER widget.
<code>HEADER_GetHeight()</code>	Returns the height of the given HEADER widget.
<code>HEADER_GetItemText()</code>	Returns the text for displaying an item with the given index.
<code>HEADER_GetItemWidth()</code>	Returns the item width of the given HEADER widget.
<code>HEADER_GetNumItems()</code>	Returns the number of items of the given HEADER widget.
<code>HEADER_GetSel()</code>	Returns the current selection of the HEADER widget.
<code>HEADER_GetTextColor()</code>	Returns the text color of the given HEADER widget.
<code>HEADER_GetUserData()</code>	Retrieves the data set with <code>HEADER_SetUserData()</code> .
<code>HEADER_SetBitmap()</code>	Sets the bitmap used when displaying the specified item.
<code>HEADER_SetBitmapEx()</code>	Sets the bitmap used when displaying the specified item.
<code>HEADER_SetBkColor()</code>	Sets the background color of the given HEADER widget.
<code>HEADER_SetBMP()</code>	Sets the bitmap used when displaying the specified item.
<code>HEADER_SetBMPEX()</code>	Sets the bitmap used when displaying the specified item.
<code>HEADER_SetDefaultBkColor()</code>	Sets the default background color used when creating a HEADER widget.
<code>HEADER_SetDefaultBorderH()</code>	Sets the value used for the horizontal spacing when creating a HEADER widget.
<code>HEADER_SetDefaultBorderV()</code>	Sets the value used for the vertical spacing when creating a HEADER widget.
<code>HEADER_SetDefaultCursor()</code>	Sets the cursor which will be displayed when dragging the width of an HEADER item.
<code>HEADER_SetDefaultFont()</code>	Sets the default font used when creating a HEADER widget.
<code>HEADER_SetDefaultTextColor()</code>	Returns the default text color used when creating a HEADER widget.
<code>HEADER_SetDragLimit()</code>	Sets the limit for dragging the dividers on or off.
<code>HEADER_SetFixed()</code>	Fixes the given number of columns at their horizontal positions.
<code>HEADER_SetFont()</code>	Sets the font used when displaying the given HEADER widget.
<code>HEADER_SetHeight()</code>	Sets the height of the given HEADER widget.

<b>Routine</b>	<b>Description</b>
<code>HEADER_SetItemText()</code>	Sets the text used when displaying the specified item.
<code>HEADER_SetItemWidth()</code>	Sets the width of the specified HEADER item.
<code>HEADER_SetScrollPos()</code>	Sets the horizontal scrolling position of the HEADER widget in pixels.
<code>HEADER_SetStreamedBitmap()</code>	Sets the bitmap used when displaying the specified item.
<code>HEADER_SetStreamedBitmapEx()</code>	Sets the bitmap used when displaying the specified item.
<code>HEADER_SetTextAlign()</code>	Sets the text alignment of the specified HEADER item.
<code>HEADER_SetTextColor()</code>	Sets the text color used when displaying the widget.
<code>HEADER_SetUserData()</code>	Sets the extra data of a HEADER widget.

### 7.2.12.4.1 HEADER\_AddItem()

#### Description

Adds an item to an already existing HEADER widget.

#### Prototype

```
void HEADER_AddItem(    HEADER_Handle  hObj,
                       int            Width,
                       const char     * s,
                       int            Align);
```

#### Parameters

Parameter	Description
<code>hObj</code>	Handle of HEADER widget.
<code>Width</code>	<code>Width</code> of the new item.
<code>s</code>	Text to be displayed.
<code>Align</code>	Text alignment mode to set. List of flags can be found under <i>Text alignment flags</i> on page 286.

#### Additional information

The `Width`-parameter can be 0. If `Width = 0` the width of the new item will be calculated by the given text and by the default value of the horizontal spacing.

### 7.2.12.4.2 HEADER\_Create()

#### Note

This function is **deprecated**, `HEADER_CreateEx()` should be used instead.

#### Description

Creates a HEADER widget of a specified size at a specified location.

#### Prototype

```
HEADER_Handle HEADER_Create(int    x0,
                           int    y0,
                           int    xSize,
                           int    ySize,
                           WM_HWIN hParent,
                           int    Id,
                           int    Flags,
                           int    ExFlags);
```

#### Parameters

Parameter	Description
<code>x0</code>	Leftmost pixel of the HEADER widget (in parent coordinates).
<code>y0</code>	Topmost pixel of the HEADER widget (in parent coordinates).
<code>xSize</code>	Horizontal size of the HEADER widget (in pixels).
<code>ySize</code>	Vertical size of the HEADER widget (in pixels).
<code>hParent</code>	Handle of the parent window
<code>Id</code>	<code>Id</code> of the new HEADER widget
<code>Flags</code>	Window create flags. Typically <code>WM_CF_SHOW</code> in order to make the widget visible immediately (refer to <i>Window create flags</i> on page 1146 for a list of available parameter values).
<code>ExFlags</code>	(Reserved for later use)

#### Return value

Handle of the created HEADER widget; 0 if the function fails.



### 7.2.12.4.3 HEADER\_CreateAttached()

#### Description

Creates a HEADER widget which is attached to an existing window.

#### Prototype

```
HEADER_Handle HEADER_CreateAttached(WM_HWIN hParent,  
                                     int      Id,  
                                     int      SpecialFlags);
```

#### Parameters

Parameter	Description
<a href="#">hObj</a>	Handle HEADER of widget
<a href="#">Id</a>	<a href="#">Id</a> of the HEADER widget
<a href="#">SpecialFlags</a>	(Not used, reserved for later use)

#### Return value

Handle of the created HEADER widget; 0 if the function fails.

#### Additional information

An attached HEADER widget is essentially a child window which will position itself on the parent window and operate accordingly.

### 7.2.12.4.4 HEADER\_CreateEx()

#### Description

Creates a HEADER widget of a specified size at a specified location.

#### Prototype

```
HEADER_Handle HEADER_CreateEx(int    x0,
                              int    y0,
                              int    xSize,
                              int    ySize,
                              WM_HWIN hParent,
                              int    WinFlags,
                              int    ExFlags,
                              int    Id);
```

#### Parameters

Parameter	Description
<code>x0</code>	Leftmost pixel of the widget (in parent coordinates).
<code>y0</code>	Topmost pixel of the widget (in parent coordinates).
<code>xSize</code>	Horizontal size of the widget (in pixels).
<code>ySize</code>	Vertical size of the widget (in pixels).
<code>hParent</code>	Handle of parent window. If 0, the new HEADER widget will be a child of the desktop (top-level window).
<code>WinFlags</code>	Window create flags. Typically <code>WM_CF_SHOW</code> in order to make the widget visible immediately (refer to <i>Window create flags</i> on page 1146 for a list of available parameter values).
<code>ExFlags</code>	Not used, reserved for future use.
<code>Id</code>	Window ID of the widget.

#### Return value

Handle of the created HEADER widget; 0 if the function fails.

#### 7.2.12.4.5 HEADER\_CreateIndirect()

##### Description

The prototype of this function is explained at the beginning of this chapter. For details the function `<WIDGET>_CreateIndirect()` on page 1161 should be referred to. The element `Flags` is used according to the parameter `WinFlags` of the function `HEADER_CreateEx()`. The element `Para` is not used.

#### 7.2.12.4.6 HEADER\_CreateUser()

##### Description

Prototype explained at the beginning of the chapter as `<WIDGET>_CreateUser()` on page 1162. For a detailed description of the parameters the function `HEADER_CreateEx()` can be referred to.

### 7.2.12.4.7 HEADER\_DeleteItem()

#### Description

Deletes an item from the HEADER widget.

#### Prototype

```
void HEADER_DeleteItem(HEADER_Handle hObj,  
                       unsigned      Index);
```

#### Parameters

Parameter	Description
<a href="#">hObj</a>	Handle of HEADER widget.
<a href="#">Index</a>	<a href="#">Index</a> of HEADER item.

#### 7.2.12.4.8 HEADER\_GetBkColor()

##### Description

Returns the background color of the given HEADER widget.

##### Prototype

```
GUI_COLOR HEADER_GetBkColor(HEADER_Handle hObj);
```

##### Parameters

Parameter	Description
<a href="#">hObj</a>	Handle of HEADER widget.

##### Return value

The background color of the given HEADER widget.

### 7.2.12.4.9 HEADER\_GetBorderH()

#### Description

Returns the horizontal border size of the HEADER.

#### Prototype

```
U8 HEADER_GetBorderH(HEADER_Handle hObj);
```

#### Parameters

Parameter	Description
<a href="#">hObj</a>	Handle of HEADER widget.

#### Return value

Horizontal border size of the HEADER.

#### 7.2.12.4.10 HEADER\_GetBorderV()

##### Description

Returns the vertical border size of the HEADER.

##### Prototype

```
U8 HEADER_GetBorderV(HEADER_Handle hObj);
```

##### Parameters

Parameter	Description
<a href="#">hObj</a>	Handle of HEADER widget.

##### Return value

Vertical border size of the HEADER.



### 7.2.12.4.11 HEADER\_GetColumnFromPos()

#### Description

Returns the index of the column matching the given X-position.

#### Prototype

```
int HEADER_GetColumnFromPos(HEADER_Handle hObj,  
                             int          x);
```

#### Parameters

Parameter	Description
<code>hObj</code>	Handle of HEADER widget.
<code>x</code>	X-position of the item.

#### Return value

- = -1     Error.
- ≠ -1    Zero-based index of the item matching the X-position.

#### 7.2.12.4.12 HEADER\_GetDefaultBkColor()

##### Description

Returns the default background color used when creating a HEADER widget.

##### Prototype

```
GUI_COLOR HEADER_GetDefaultBkColor(void);
```

##### Return value

Default background color used when creating a HEADER widget.

### 7.2.12.4.13 HEADER\_GetDefaultBorderH()

#### Description

Returns the value used for the horizontal spacing when creating a HEADER widget.

#### Prototype

```
int HEADER_GetDefaultBorderH(void);
```

#### Return value

Value used for the horizontal spacing when creating a HEADER widget.

#### Additional information

Horizontal spacing means the horizontal distance in pixel between text and the horizontal border of the item. Horizontal spacing takes effect only if the given width of a new item is 0.

#### 7.2.12.4.14 HEADER\_GetDefaultBorderV()

##### Description

Returns the value used for the vertical spacing when creating a HEADER widget.

##### Prototype

```
int HEADER_GetDefaultBorderV(void);
```

##### Return value

Value used for the vertical spacing when creating a HEADER widget.

##### Additional information

Vertical spacing means the vertical distance in pixel between text and the vertical border of the HEADER widget.

#### 7.2.12.4.15 HEADER\_GetDefaultCursor()

##### Description

Returns a pointer to the cursor displayed when dragging the width of an item.

##### Prototype

```
GUI_CURSOR *HEADER_GetDefaultCursor(void);
```

##### Return value

Pointer to the cursor displayed when dragging the width of an item.

#### 7.2.12.4.16 HEADER\_GetDefaultFont()

##### Description

Returns a pointer to the default font used when creating a HEADER widget.

##### Prototype

```
GUI_FONT *HEADER_GetDefaultFont(void);
```

##### Return value

Pointer to the default font used when creating a HEADER widget.

#### 7.2.12.4.17 HEADER\_GetDefaultTextColor()

##### Description

Returns the default text color used when creating a HEADER widget.

##### Prototype

```
GUI_COLOR HEADER_GetDefaultTextColor(void);
```

##### Return value

Default text color used when creating a HEADER widget.

### 7.2.12.4.18 HEADER\_GetFont()

#### Description

Returns the font of the given HEADER widget.

#### Prototype

```
GUI_FONT *HEADER_GetFont(HEADER_Handle hObj);
```

#### Parameters

Parameter	Description
<a href="#">hObj</a>	Handle of HEADER widget.

#### Return value

The currently set font of the given HEADER widget.



#### 7.2.12.4.19 HEADER\_GetHeight()

##### Description

Returns the height of the given HEADER widget.

##### Prototype

```
int HEADER_GetHeight(HEADER_Handle hObj);
```

##### Parameters

Parameter	Description
<a href="#">hObj</a>	Handle of HEADER widget.

##### Return value

Height of the given HEADER widget.

#### 7.2.12.4.20 HEADER\_GetItemText()

##### Description

Returns the text for displaying an item with the given index.

##### Prototype

```
int HEADER_GetItemText(HEADER_Handle hObj,  
                      unsigned Index,  
                      char * pBuffer,  
                      int MaxSize);
```

##### Parameters

Parameter	Description
<a href="#">hObj</a>	Handle of HEADER widget.
<a href="#">Index</a>	<a href="#">Index</a> of HEADER item.
<a href="#">pBuffer</a>	Pointer to a buffer to hold the retrieved text.
<a href="#">MaxSize</a>	The size of <a href="#">pBuffer</a> .

### 7.2.12.4.21 HEADER\_GetItemWidth()

#### Description

Returns the item width of the given HEADER widget.

#### Prototype

```
int HEADER_GetItemWidth(HEADER_Handle hObj,  
                        unsigned int Index);
```

#### Parameters

Parameter	Description
<a href="#">hObj</a>	Handle of HEADER widget.
<a href="#">Index</a>	<a href="#">Index</a> of the item.

#### Return value

Width of the item.

#### 7.2.12.4.22 HEADER\_GetNumItems()

##### Description

Returns the number of items of the given HEADER widget.

##### Prototype

```
int HEADER_GetNumItems(HEADER_Handle hObj);
```

##### Parameters

Parameter	Description
<a href="#">hObj</a>	Handle of HEADER widget.

##### Return value

Number of items of the given HEADER widget.

### 7.2.12.4.23 HEADER\_GetSel()

#### Description

Returns the current selection of the HEADER widget.

#### Prototype

```
int HEADER_GetSel(HEADER_Handle hObj);
```

#### Parameters

Parameter	Description
<code>hObj</code>	Handle of HEADER widget.

#### Return value

Current selection.

#### 7.2.12.4.24 HEADER\_GetTextColor()

##### Description

Returns the text color of the given HEADER widget.

##### Prototype

```
GUI_COLOR HEADER_GetTextColor(HEADER_Handle hObj);
```

##### Parameters

Parameter	Description
<a href="#">hObj</a>	Handle of HEADER widget.

##### Return value

The text color of the given HEADER widget.

#### 7.2.12.4.25 HEADER\_GetUserData()

##### **Description**

Prototype explained at the beginning of the chapter as `<WIDGET>_GetUserData()` on page 1165.

### 7.2.12.4.26 HEADER\_SetBitmap()

#### Description

Sets the bitmap used when displaying the specified item.

#### Prototype

```
void HEADER_SetBitmap(    HEADER_Handle  hObj,  
                        unsigned       Index,  
                        const GUI_BITMAP * pBitmap);
```

#### Parameters

Parameter	Description
<a href="#">hObj</a>	Handle of HEADER widget
<a href="#">Index</a>	<a href="#">Index</a> of the item
<a href="#">pBitmap</a>	Pointer to a bitmap structure to be displayed

#### Additional information

One item of a HEADER widget can contain text and a bitmap. Have a look at the example at [HEADER\\_SetBitmapEx\(\)](#).



### 7.2.12.4.27 HEADER\_SetBitmapEx()

#### Description

Sets the bitmap used when displaying the specified item.

#### Prototype

```
void HEADER_SetBitmapEx(    HEADER_Handle  hObj,
                           unsigned      Index,
                           const GUI_BITMAP * pBitmap,
                           int           x,
                           int           y);
```

#### Parameters

Parameter	Description
<code>hObj</code>	Handle of HEADER widget
<code>Index</code>	<code>Index</code> of the item
<code>pBitmap</code>	Pointer to a bitmap structure to be displayed
<code>x</code>	Additional offset in <code>x</code>
<code>y</code>	Additional offset in <code>y</code>

#### Additional information

One item of a HEADER widget can contain text and a bitmap.

#### Example

```
...
HEADER_Handle hHeader;
GUI_Init();
HEADER_SetDefaultTextColor(GUI_YELLOW);
HEADER_SetDefaultFont(&GUI_Font8x8);
hHeader = HEADER_Create(10, 10, 100, 40, WM_HBKWIN, 1234, WM_CF_SHOW, 0);
HEADER_AddItem(hHeader, 50, "Phone", GUI_TA_BOTTOM | GUI_TA_HCENTER);
HEADER_AddItem(hHeader, 50, "Code", GUI_TA_BOTTOM | GUI_TA_HCENTER);
HEADER_SetBitmapEx(hHeader, 0, &bmPhone, 0, -15);
HEADER_SetBitmapEx(hHeader, 1, &bmCode, 0, -15);
...
```

#### Screenshot of above example



### 7.2.12.4.28 HEADER\_SetBkColor()

#### Description

Sets the background color of the given HEADER widget.

#### Prototype

```
void HEADER_SetBkColor(HEADER_Handle hObj,  
                      GUI_COLOR      Color);
```

#### Parameters

Parameter	Description
<code>hObj</code>	Handle of HEADER widget.
<code>Color</code>	Background color to be set.

### 7.2.12.4.29 HEADER\_SetBMP()

#### Description

Sets the bitmap used when displaying the specified item.

#### Prototype

```
void HEADER_SetBMP(      HEADER_Handle  hObj,  
                        unsigned int   Index,  
                        const void     * pBitmap);
```

#### Parameters

Parameter	Description
<a href="#">hObj</a>	Handle of HEADER widget
<a href="#">Index</a>	<a href="#">Index</a> of HEADER item
<a href="#">pBitmap</a>	Pointer to bitmap file data

#### Additional information

For additional information regarding bitmap files, refer to the chapter *Displaying bitmap files* on page 446.

### 7.2.12.4.30 HEADER\_SetBMPEx()

#### Description

Sets the bitmap used when displaying the specified item.

#### Prototype

```
void HEADER_SetBMPEx(    HEADER_Handle  hObj,  
                        unsigned int   Index,  
                        const void     * pBitmap,  
                        int            x,  
                        int            y);
```

#### Parameters

Parameter	Description
<a href="#">hObj</a>	Handle of HEADER widget
<a href="#">Index</a>	<a href="#">Index</a> of HEADER item
<a href="#">pBitmap</a>	Pointer to bitmap file data
<a href="#">x</a>	Additional offset in <a href="#">x</a>
<a href="#">y</a>	Additional offset in <a href="#">y</a>

#### Additional information

For additional information regarding bitmap files, refer to the chapter *Displaying bitmap files* on page 446.

### 7.2.12.4.31 HEADER\_SetBorderH()

#### Description

Sets the horizontal border size of the HEADER.

#### Prototype

```
void HEADER_SetBorderH(HEADER_Handle hObj,  
                       U8            Border);
```

#### Parameters

Parameter	Description
<code>hObj</code>	Handle of HEADER widget.
<code>Border</code>	New horizontal border size.

### 7.2.12.4.32 HEADER\_SetBorderV()

#### Description

Sets the vertical border size of the HEADER.

#### Prototype

```
void HEADER_SetBorderV(HEADER_Handle hObj,  
                       U8            Border);
```

#### Parameters

Parameter	Description
<code>hObj</code>	Handle of HEADER widget.
<code>Border</code>	New vertical border size.

### 7.2.12.4.33 HEADER\_SetDefaultBkColor()

#### Description

Sets the default background color used when creating a HEADER widget.

#### Prototype

```
GUI_COLOR HEADER_SetDefaultBkColor(GUI_COLOR Color);
```

#### Parameters

Parameter	Description
Color	Background color to be used

#### Return value

Previous default background color.

#### 7.2.12.4.34 HEADER\_SetDefaultBorderH()

##### Description

Sets the value used for the horizontal spacing when creating a HEADER widget.

##### Prototype

```
int HEADER_SetDefaultBorderH(int Spacing);
```

##### Parameters

Parameter	Description
Spacing	Value to be used

##### Return value

Previous default value.

##### Additional information

Horizontal spacing means the horizontal distance in pixel between text and the horizontal border of the item. Horizontal spacing takes effect only if the given width of a new item is 0.



### 7.2.12.4.35 HEADER\_SetDefaultBorderV()

#### Description

Sets the value used for the vertical spacing when creating a HEADER widget.

#### Prototype

```
int HEADER_SetDefaultBorderV(int Spacing);
```

#### Parameters

Parameter	Description
Spacing	Value to be used

#### Return value

Previous default value.

#### Additional information

Vertical spacing means the vertical distance in pixel between text and the vertical border of the HEADER widget.

### 7.2.12.4.36 HEADER\_SetDefaultCursor()

#### Description

Sets the cursor which will be displayed when dragging the width of an HEADER item.

#### Prototype

```
GUI_CURSOR *HEADER_SetDefaultCursor(const GUI_CURSOR * pCursor);
```

#### Parameters

Parameter	Description
<code>pCursor</code>	Pointer to the cursor to be shown when dragging the width of an HEADER item

#### Return value

Pointer to the previous default cursor.

#### Additional information

There are 2 predefined cursors shown at the beginning of this chapter.

### 7.2.12.4.37 HEADER\_SetDefaultFont()

#### Description

Sets the default font used when creating a HEADER widget.

#### Prototype

```
GUI_FONT *HEADER_SetDefaultFont(const GUI_FONT * pFont);
```

#### Parameters

Parameter	Description
<code>pFont</code>	Pointer to font to be used

#### Return value

Pointer to previous default font.

### 7.2.12.4.38 HEADER\_SetDefaultTextColor()

#### Description

Returns the default text color used when creating a HEADER widget.

#### Prototype

```
GUI_COLOR HEADER_SetDefaultTextColor(GUI_COLOR Color);
```

#### Parameters

Parameter	Description
Color	Color to be used

#### Return value

Previous default value.

### 7.2.12.4.39 HEADER\_SetDragLimit()

#### Description

Sets the limit for dragging the dividers on or off. If the limit is on, a divider can only be dragged within the widget area. If the limit is off, it can be dragged outside the widget.

#### Prototype

```
void HEADER_SetDragLimit(HEADER_Handle hObj,  
                        unsigned      OnOff);
```

#### Parameters

Parameter	Description
<a href="#">hObj</a>	Handle of HEADER widget.
<a href="#">OnOff</a>	1 for setting the drag limit on, 0 for off.

#### 7.2.12.4.40 HEADER\_SetFixed()

##### Description

Fixes the given number of columns at their horizontal positions.

##### Prototype

```
unsigned HEADER_SetFixed(HEADER_Handle hObj,  
                        unsigned Fixed);
```

##### Parameters

Parameter	Description
<code>hObj</code>	Handle of HEADER widget.
<code>Fixed</code>	Number of columns to be fixed at their horizontal positions.

##### Return value

Old value of fixed columns.

##### Additional information

Using this function makes sense if one or more columns should remain at their horizontal positions during scrolling operations.

#### 7.2.12.4.41 HEADER\_SetFont()

##### Description

Sets the font used when displaying the given HEADER widget.

##### Prototype

```
void HEADER_SetFont(      HEADER_Handle  hObj,  
                      const GUI_FONT    * pFont);
```

##### Parameters

Parameter	Description
<code>hObj</code>	Handle of HEADER widget.
<code>pFont</code>	Pointer to font to be used.

#### 7.2.12.4.42 HEADER\_SetHeight()

##### Description

Sets the height of the given HEADER widget.

##### Prototype

```
void HEADER_SetHeight(HEADER_Handle hObj,  
                      int           Height);
```

##### Parameters

Parameter	Description
<code>hObj</code>	Handle of HEADER widget.
<code>Height</code>	New height.



#### 7.2.12.4.43 HEADER\_SetItemText()

##### Description

Sets the text used when displaying the specified item.

##### Prototype

```
void HEADER_SetItemText(    HEADER_Handle  hObj,  
                           unsigned int   Index,  
                           const char    * s);
```

##### Parameters

Parameter	Description
<a href="#">hObj</a>	Handle of HEADER widget.
<a href="#">Index</a>	<a href="#">Index</a> of HEADER item.
<a href="#">s</a>	Pointer to string to be displayed.

##### Additional information

One HEADER item can contain a string and a bitmap.

#### 7.2.12.4.44 HEADER\_SetItemWidth()

##### Description

Sets the width of the specified HEADER item.

##### Prototype

```
void HEADER_SetItemWidth(HEADER_Handle hObj,  
                          unsigned int  Index,  
                          int           Width);
```

##### Parameters

Parameter	Description
<a href="#">hObj</a>	Handle of HEADER widget.
<a href="#">Index</a>	<a href="#">Index</a> of HEADER item.
<a href="#">Width</a>	New width.

#### 7.2.12.4.45 HEADER\_SetScrollPos()

##### Description

Sets the horizontal scrolling position of the HEADER widget in pixels.

##### Prototype

```
void HEADER_SetScrollPos(HEADER_Handle hObj,  
                        int ScrollPos);
```

##### Parameters

Parameter	Description
<code>hObj</code>	Handle of HEADER widget.
<code>ScrollPos</code>	New scroll position in pixels.

#### 7.2.12.4.46 HEADER\_SetStreamedBitmap()

##### Description

Sets the bitmap used when displaying the specified item.

##### Prototype

```
void HEADER_SetStreamedBitmap(    HEADER_Handle    hObj,  
                                unsigned int    Index,  
                                const GUI_BITMAP_STREAM * pBitmap);
```

##### Parameters

Parameter	Description
<a href="#">hObj</a>	Handle of HEADER widget
<a href="#">Index</a>	<a href="#">Index</a> of the item
<a href="#">pBitmap</a>	Pointer to streamed bitmap data to be displayed

##### Additional information

For additional information regarding streamed bitmap files, refer to the chapter *2-D Graphic Library* on page 311.

### 7.2.12.4.47 HEADER\_SetStreamedBitmapEx()

#### Description

Sets the bitmap used when displaying the specified item.

#### Prototype

```
void HEADER_SetStreamedBitmapEx(    HEADER_Handle    hObj,
                                   unsigned int        Index,
                                   const GUI_BITMAP_STREAM * pBitmap,
                                   int                  x,
                                   int                  y);
```

#### Parameters

Parameter	Description
<a href="#">hObj</a>	Handle of HEADER widget
<a href="#">Index</a>	<a href="#">Index</a> of the item
<a href="#">pBitmap</a>	Pointer to streamed bitmap data to be displayed
<a href="#">x</a>	Additional offset in <a href="#">x</a>
<a href="#">y</a>	Additional offset in <a href="#">y</a>

#### Additional information

For additional information regarding streamed bitmap files, refer to the chapter *2-D Graphic Library* on page 311.

#### 7.2.12.4.48 HEADER\_SetTextAlign()

##### Description

Sets the text alignment of the specified HEADER item.

##### Prototype

```
void HEADER_SetTextAlign(HEADER_Handle hObj,  
                        unsigned int  Index,  
                        int           Align);
```

##### Parameters

Parameter	Description
<code>hObj</code>	Handle of HEADER widget.
<code>Index</code>	<code>Index</code> of HEADER item.
<code>Align</code>	Text alignment mode to set. List of flags can be found under <i>Text alignment flags</i> on page 286.

#### 7.2.12.4.49 HEADER\_SetTextColor()

##### Description

Sets the text color used when displaying the widget.

##### Prototype

```
void HEADER_SetTextColor(HEADER_Handle hObj,  
                        GUI_COLOR      Color);
```

##### Parameters

Parameter	Description
<code>hObj</code>	Handle of HEADER widget.
<code>Color</code>	<code>Color</code> to be used.

#### 7.2.12.4.50 HEADER\_SetUserData()

##### **Description**

Prototype explained at the beginning of the chapter as `<WIDGET>_SetUserData()` on page 1166.



## 7.2.12.5 Example

The `Sample` folder contains the following example which shows how the widget can be used:

- `WIDGET_Header.c`

Note that several other examples also make use of this widget and may also be helpful to get familiar with the widget.

### Screenshot of `WIDGET_Header.c`:

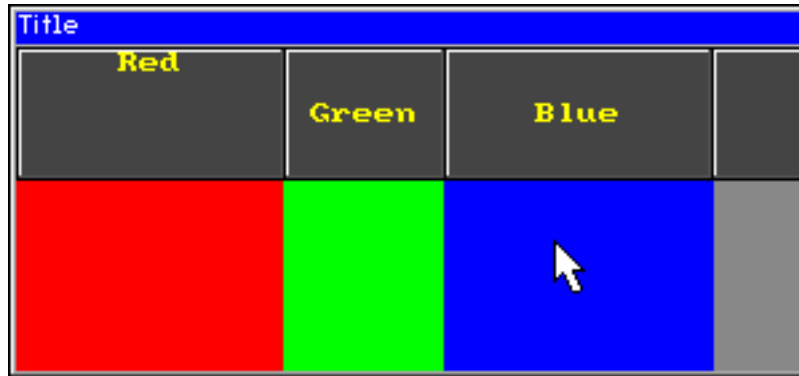

## 7.2.13 ICONVIEW: Icon view widget

The ICONVIEW widget can be used for icon based menus often required in hand held devices like mobile telephones or pocket organizers. It shows a list of icons where each icon can be labeled with optional text. Icon view widgets support transparency and alpha blending. So any content can be shown in the background. The currently selected icon can be highlighted by a solid color or with an alpha blending effect, which lets the background shine through. If required a scroll bar can be shown.

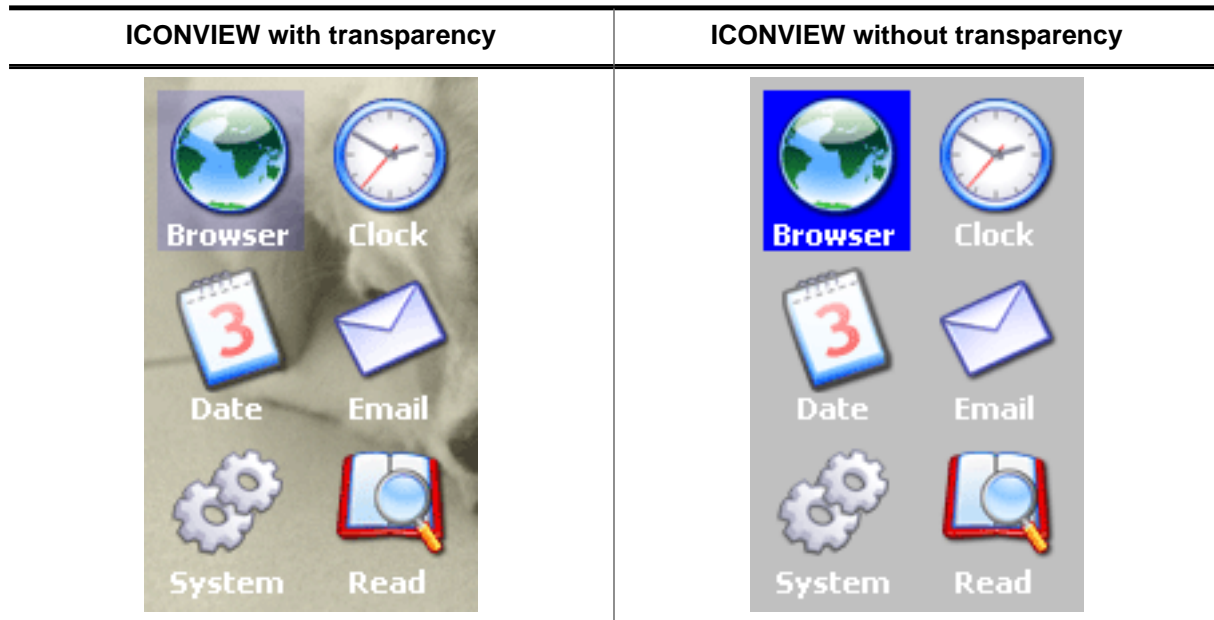

### Note

All ICONVIEW-related routines are located in the file(s) ICONVIEW\*.c, ICONVIEW\*.h. All identifiers are prefixed ICONVIEW.

### 7.2.13.1 Configuration options

Type	Macro	Default	Description
N	ICONVIEW_BKCOLOR0_DEFAULT	GUI_WHITE	Background color, unselected state.
N	ICONVIEW_BKCOLOR1_DEFAULT	GUI_BLUE	Background color, selected state.
N	ICONVIEW_TEXTCOLOR0_DEFAULT	GUI_WHITE	Text color, unselected state.
N	ICONVIEW_TEXTCOLOR1_DEFAULT	GUI_WHITE	Text color, selected state.
S	ICONVIEW_FONT_DEFAULT	GUI_Font13_1	Font to be used for drawing the labels.
N	ICONVIEW_FRAMEX_DEFAULT	5	Free space between the icons and the left and right border of the widget.
N	ICONVIEW_FRAMEY_DEFAULT	5	Free space between the icons and the top and bottom border of the widget.
N	ICONVIEW_SPACEX_DEFAULT	5	Free horizontal space between the icons.
N	ICONVIEW_SPACEY_DEFAULT	5	Free vertical space between the icons.

Type	Macro	Default	Description
N	ICONVIEW_ALIGN_DEFAULT	GUI_TA_HCENTER   GUI_TA_BOTTOM	Default alignment to be used for drawing the labels.

### 7.2.13.2 Predefined IDs

The following symbols define IDs which may be used to make ICONVIEW widgets distinguishable from creation.

```
#define GUI_ID_ICONVIEW0    0x250
#define GUI_ID_ICONVIEW1    0x251
#define GUI_ID_ICONVIEW2    0x252
#define GUI_ID_ICONVIEW3    0x253
#define GUI_ID_ICONVIEW4    0x254
#define GUI_ID_ICONVIEW5    0x255
#define GUI_ID_ICONVIEW6    0x256
#define GUI_ID_ICONVIEW7    0x257
#define GUI_ID_ICONVIEW8    0x258
#define GUI_ID_ICONVIEW9    0x259
```

### 7.2.13.3 Notification codes

The following events are sent from an ICONVIEW widget to its parent window as part of a WM\_NOTIFY\_PARENT message:

Message	Description
WM_NOTIFICATION_CLICKED	Widget has been clicked.
WM_NOTIFICATION_RELEASED	Widget has been released.
WM_NOTIFICATION_MOVED_OUT	Widget has been clicked and pointer has been moved out of the widget area without releasing.
WM_NOTIFICATION_SCROLL_CHANGED	The scroll position of the optional scroll bar has been changed.
WM_NOTIFICATION_SEL_CHANGED	The selection of the widget has been changed.

### 7.2.13.4 Keyboard reaction

The widget reacts to the following keys if it has the input focus:

Key	Reaction
GUI_KEY_RIGHT	Moves the selection to the next icon.
GUI_KEY_LEFT	Moves the selection to the previous icon.
GUI_KEY_DOWN	Moves the selection down.
GUI_KEY_UP	Moves the selection up.
GUI_KEY_HOME	Moves the selection to the first icon.
GUI_KEY_END	Moves the selection to the last icon.

## 7.2.13.5 ICONVIEW API

The table below lists the available emWin ICONVIEW-related routines in alphabetical order. Detailed descriptions of the routines follow.

### Functions

Routine	Description
<code>ICONVIEW_AddBitmapItem()</code>	Adds a new bitmap icon to the widget.
<code>ICONVIEW_AddStreamedBitmapItem()</code>	Adds a new streamed bitmap icon to the widget.
<code>ICONVIEW_CreateEx()</code>	Creates an ICONVIEW widget.
<code>ICONVIEW_CreateIndirect()</code>	Creates an ICONVIEW widget from a resource table entry.
<code>ICONVIEW_CreateUser()</code>	Creates an ICONVIEW widget using extra bytes as user data.
<code>ICONVIEW_DeleteItem()</code>	Deletes an existing item.
<code>ICONVIEW_EnableStreamAuto()</code>	Enables full support for streamed bitmaps.
<code>ICONVIEW_GetBkColor()</code>	Returns the background color of the widget.
<code>ICONVIEW_GetFont()</code>	Returns the font of the widget.
<code>ICONVIEW_GetItemBitmap()</code>	Retrieves the bitmap of a specified ICONVIEW item.
<code>ICONVIEW_GetItemText()</code>	Retrieves the text of a specified ICONVIEW item.
<code>ICONVIEW_GetItemUserData()</code>	Retrieves the previously stored user data from a specific item.
<code>ICONVIEW_GetNumItems()</code>	Returns the number of items in the given ICONVIEW widget.
<code>ICONVIEW_GetReleasedItem()</code>	This function returns the index of the released ICONVIEW item.
<code>ICONVIEW_GetSel()</code>	Returns the zero based index of the currently selected icon.
<code>ICONVIEW_GetTextColor()</code>	Returns the text color of the widget.
<code>ICONVIEW_GetUserData()</code>	Retrieves the data set with <code>ICONVIEW_SetUserData()</code> .
<code>ICONVIEW_InsertBitmapItem()</code>	Inserts a new bitmap icon to the widget.
<code>ICONVIEW_InsertStreamedBitmapItem()</code>	Inserts a new streamed bitmap icon to the widget.
<code>ICONVIEW_OwnerDraw()</code>	Default function for drawing a ICONVIEW widget.
<code>ICONVIEW_SetBitmapItem()</code>	Sets a bitmap to be used by a specific item.
<code>ICONVIEW_SetBkColor()</code>	Sets the background color of the widget.
<code>ICONVIEW_SetFont()</code>	Sets the font to be used for drawing the icon labels.
<code>ICONVIEW_SetFrame()</code>	Sets the size of the frame between the border of the widget and the icons.
<code>ICONVIEW_SetIconAlign()</code>	Sets the icon alignment.
<code>ICONVIEW_SetItemText()</code>	Sets the text of a specific item.
<code>ICONVIEW_SetItemUserData()</code>	Stores user data in a specific item.

Routine	Description
<code>ICONVIEW_SetOwnerDraw()</code>	Sets a custom defined drawing function.
<code>ICONVIEW_SetSel()</code>	Sets the current selection.
<code>ICONVIEW_SetSpace()</code>	Sets the space between icons in x- or y-direction.
<code>ICONVIEW_SetStreamedBitmapItem()</code>	Sets a streamed bitmap to be used by a specific item.
<code>ICONVIEW_SetTextAlign()</code>	Sets the text align of the item texts.
<code>ICONVIEW_SetTextColor()</code>	Sets the color to be used to draw the labels.
<code>ICONVIEW_SetUserData()</code>	Sets the extra data of an ICONVIEW widget.
<code>ICONVIEW_SetWrapMode()</code>	Sets the wrapping mode to be used for the given ICONVIEW widget.

## Defines

Group of defines	Description
<code>ICONVIEW alignment flags</code>	Alignment flags used for <code>ICONVIEW_SetIconAlign()</code> .
<code>ICONVIEW color indexes</code>	Color indexes used by the ICONVIEW widget.
<code>ICONVIEW create flags</code>	Create flags used for ICONVIEW widgets.

## 7.2.13.5.1 Functions

### 7.2.13.5.1.1 ICONVIEW\_AddBitmapItem()

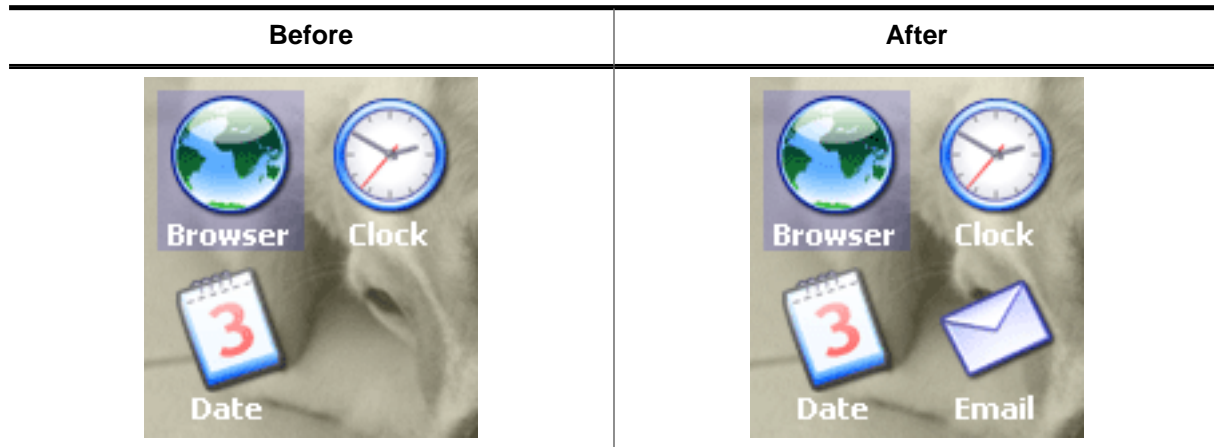

#### Description

Adds a new bitmap icon to the widget.

#### Prototype

```
int ICONVIEW_AddBitmapItem(    ICONVIEW_Handle  hObj,
                             const GUI_BITMAP  * pBitmap,
                             const char       * pText);
```

#### Parameters

Parameter	Description
<code>hObj</code>	Handle of ICONVIEW widget.
<code>pBitmap</code>	Pointer to a bitmap structure used to draw the icon.
<code>pText</code>	Text to be used to label the icon.

#### Return value

= 0      on success  
 ≠ 0      on error.

#### Additional information

Note that the bitmap pointer needs to remain valid.

### 7.2.13.5.1.2 ICONVIEW\_AddStreamedBitmapItem()

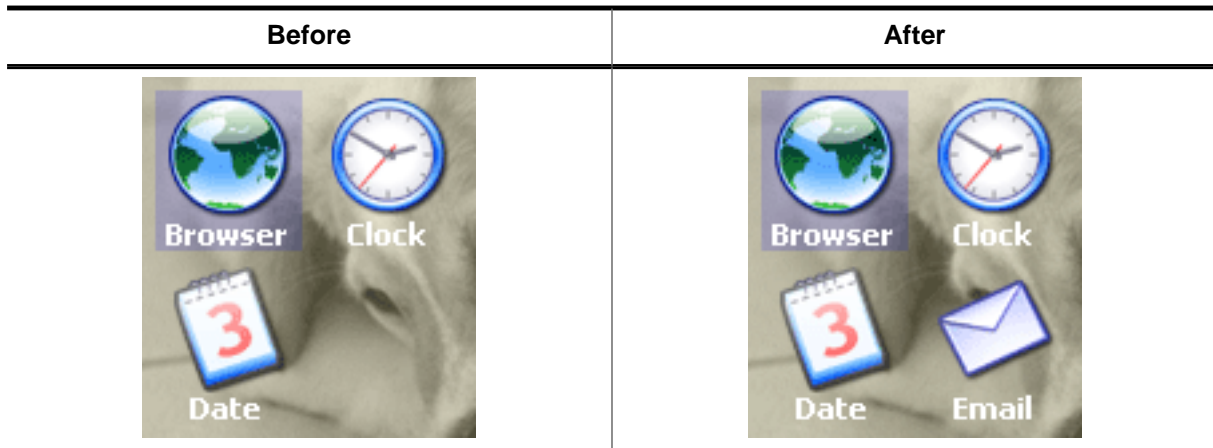

#### Description

Adds a new streamed bitmap icon to the widget.

#### Prototype

```
int ICONVIEW_AddStreamedBitmapItem(    ICONVIEW_Handle  hObj,
                                       const void          * pStreamedBitmap,
                                       const char           * pText);
```

#### Parameters

Parameter	Description
<code>hObj</code>	Handle of ICONVIEW widget.
<code>pStreamedBitmap</code>	Pointer to a bitmap stream used to draw the icon.
<code>pText</code>	Text to be used to label the icon.

#### Return value

= 0      on success  
 ≠ 0      on error.

#### Additional information

The pointer to the bitmap stream needs to remain valid.

### 7.2.13.5.1.3 ICONVIEW\_CreateEx()

#### Description

Creates an ICONVIEW widget of a specified size at a specified location.

#### Prototype

```
ICONVIEW_Handle ICONVIEW_CreateEx(int    x0,
                                   int    y0,
                                   int    xSize,
                                   int    ySize,
                                   WM_HWIN hParent,
                                   int    WinFlags,
                                   int    ExFlags,
                                   int    Id,
                                   int    xSizeItems,
                                   int    ySizeItems);
```

#### Parameters

Parameter	Description
<code>x0</code>	Leftmost pixel of the widget in parent coordinates.
<code>y0</code>	Topmost pixel of the widget in parent coordinates.
<code>xSize</code>	Horizontal size of the widget in pixels.
<code>ySize</code>	Vertical size of the widget in pixels.
<code>hParent</code>	Handle of parent window. If 0, the new widget will be a child window of the desktop (top-level window).
<code>WinFlags</code>	Window create flags. Typically <code>WM_CF_SHOW</code> in order to make the widget visible immediately (refer to <i>Window create flags</i> on page 1146 for a list of available parameter values).
<code>ExFlags</code>	See <i>ICONVIEW create flags</i> on page 1643.
<code>Id</code>	Window ID of the widget.
<code>xSizeItem</code>	Horizontal icon size in pixels.
<code>ySizeItem</code>	Vertical icon size in pixels.

#### Return value

Handle of the new widget, 0 if the function fails.

#### Additional information

If the widget should be transparent, the parameter `WinFlags` should be or-combined with `WM_CF_HASTRANS`.



#### 7.2.13.5.1.4 ICONVIEW\_CreateIndirect()

##### Description

The prototype of this function is explained at the beginning of this chapter. Details can be found in the description of the function `<WIDGET>_CreateIndirect()` on page 1161. The upper 16 bit of the element `Para` of the according `GUI_WIDGET_CREATE_INFO` structure are used according to the parameter `ySizeItems` of the function `ICONVIEW_CreateEx()`. The lower 16 bit of the element `Para` are used according to the parameter `xSizeItems` of the function `ICONVIEW_CreateEx()`. The element `Flags` is used according to the parameter `WinFlags` of the function `ICONVIEW_CreateEx()`.

### 7.2.13.5.1.5 ICONVIEW\_CreateUser()

#### Description

Prototype explained at the beginning of the chapter as `<WIDGET>_CreateUser()` on page 1162. For a detailed description of the parameters the function `ICONVIEW_CreateEx()` can be referred to.

### 7.2.13.5.1.6 ICONVIEW\_DeleteItem()

#### Description

Deletes an existing item of the ICONVIEW widget.

#### Prototype

```
void ICONVIEW_DeleteItem(ICONVIEW_Handle hObj,  
                        unsigned Index);
```

#### Parameters

Parameter	Description
<a href="#">hObj</a>	Handle of ICONVIEW widget.
<a href="#">Index</a>	<a href="#">Index</a> of the item to be deleted.

### 7.2.13.5.1.7 ICONVIEW\_EnableStreamAuto()

#### Description

Enables full support for streamed bitmaps.

#### Prototype

```
void ICONVIEW_EnableStreamAuto(void);
```

#### Additional information

The ICONVIEW widget supports only index based streamed bitmaps by default. Calling this function enables support for all kinds of streamed bitmaps. This causes all drawing functions for streamed bitmaps to be referenced by the linker.

### 7.2.13.5.1.8 ICONVIEW\_GetBkColor()

#### Description

Returns the background color of the widget.

#### Prototype

```
GUI_COLOR ICONVIEW_GetBkColor(ICONVIEW_Handle hObj,  
                               int Index);
```

#### Parameters

Parameter	Description
<a href="#">hObj</a>	Handle of ICONVIEW widget.
<a href="#">Index</a>	See <i>ICONVIEW color indexes</i> on page 1642 for a full list of permitted values.

#### Return value

The background color of the given widget.

### 7.2.13.5.1.9 ICONVIEW\_GetFont()

#### Description

Returns the font of the widget.

#### Prototype

```
GUI_FONT *ICONVIEW_GetFont(ICONVIEW_Handle hObj);
```

#### Parameters

Parameter	Description
<a href="#">hObj</a>	Handle of ICONVIEW widget.

#### Return value

The font of the given widget.

### 7.2.13.5.1.10 ICONVIEW\_GetItemBitmap()

#### Description

Retrieves the bitmap of a specified ICONVIEW item.

#### Prototype

```
GUI_BITMAP *ICONVIEW_GetItemBitmap(ICONVIEW_Handle hObj,  
                                   int ItemIndex);
```

#### Parameters

Parameter	Description
<code>hObj</code>	Handle of ICONVIEW widget.
<code>ItemIndex</code>	Index of the item to be used.

#### Return value

Pointer to the bitmap of the given item.

### 7.2.13.5.1.11 ICONVIEW\_GetItemText()

#### Description

Retrieves the text of a specified ICONVIEW item.

#### Prototype

```
int ICONVIEW_GetItemText(ICONVIEW_Handle hObj,  
                        int Index,  
                        char * pBuffer,  
                        int MaxSize);
```

#### Parameters

Parameter	Description
<a href="#">hObj</a>	Handle of ICONVIEW widget.
<a href="#">Index</a>	<a href="#">Index</a> of the item to be deleted.
<a href="#">pBuffer</a>	Buffer to retrieve the text.
<a href="#">MaxSize</a>	Maximum length of text to copy to the buffer.

#### Return value

The length of the actually copied text is returned.



### 7.2.13.5.1.12 ICONVIEW\_GetItemUserData()

#### Description

Retrieves the previously stored user data from a specific item.

#### Prototype

```
U32 ICONVIEW_GetItemUserData(ICONVIEW_Handle hObj,  
                             int Index);
```

#### Parameters

Parameter	Description
<a href="#">hObj</a>	Handle of ICONVIEW widget.
<a href="#">Index</a>	<a href="#">Index</a> of the item.

#### Return value

User data stored in the item as U32.

### 7.2.13.5.1.13 ICONVIEW\_GetNumItems()

#### Description

Returns the number of items in the given ICONVIEW widget.

#### Prototype

```
int ICONVIEW_GetNumItems(ICONVIEW_Handle hObj);
```

#### Parameters

Parameter	Description
<a href="#">hObj</a>	Handle of ICONVIEW widget.

#### Return value

Number of items.

### 7.2.13.5.1.14 ICONVIEW\_GetReleasedItem()

#### Description

This function returns the index of the released ICONVIEW item.

#### Prototype

```
int ICONVIEW_GetReleasedItem(ICONVIEW_Handle hObj);
```

#### Parameters

Parameter	Description
<a href="#">hObj</a>	Handle of ICONVIEW widget.

#### Return value

Zero based index of last released item.

### 7.2.13.5.1.15 ICONVIEW\_GetSel()

#### Description

Returns the zero based index of the currently selected icon.

#### Prototype

```
int ICONVIEW_GetSel(ICONVIEW_Handle hObj);
```

#### Parameters

Parameter	Description
<a href="#">hObj</a>	Handle of ICONVIEW widget.

#### Return value

Zero based index of the currently selected icon.

### 7.2.13.5.1.16 ICONVIEW\_GetTextColor()

#### Description

Returns the text color of the widget.

#### Prototype

```
GUI_COLOR ICONVIEW_GetTextColor(ICONVIEW_Handle hObj,  
                                int Index);
```

#### Parameters

Parameter	Description
<a href="#">hObj</a>	Handle of ICONVIEW widget.
<a href="#">Index</a>	See <i>ICONVIEW color indexes</i> on page 1642 for a full list of permitted values.

#### Return value

The text color of the given widget.

### 7.2.13.5.1.17 ICONVIEW\_GetUserData()

#### Description

Prototype explained at the beginning of the chapter as `<WIDGET>_GetUserData()` on page 1165.

### 7.2.13.5.1.18 ICONVIEW\_InsertBitmapItem()

#### Description

Inserts a new bitmap icon to the widget.

#### Prototype

```
int ICONVIEW_InsertBitmapItem(    ICONVIEW_Handle  hObj,
                                const GUI_BITMAP    * pBitmap,
                                const char          * pText,
                                int                  Index);
```

#### Parameters

Parameter	Description
<code>hObj</code>	Handle of ICONVIEW widget.
<code>pBitmap</code>	Pointer to a bitmap structure used to draw the icon.
<code>pText</code>	Text to be used to label the icon.
<code>Index</code>	<code>Index</code> position to insert the item at.

#### Return value

= 0      on success  
 ≠ 0      on error.

#### Additional information

See `ICONVIEW_AddBitmapItem()` for screenshots. Note that the bitmap pointer needs to remain valid.

### 7.2.13.5.1.19 ICONVIEW\_InsertStreamedBitmapItem()

#### Description

Inserts a new streamed bitmap icon to the widget.

#### Prototype

```
int ICONVIEW_InsertStreamedBitmapItem(    ICONVIEW_Handle  hObj,
                                         const void        * pStreamedBitmap,
                                         const char        * pText,
                                         int                Index);
```

#### Parameters

Parameter	Description
<a href="#">hObj</a>	Handle of ICONVIEW widget.
<a href="#">pStreamedBitmap</a>	Pointer to a bitmap stream used to draw the icon.
<a href="#">pText</a>	Text to be used to label the icon.
<a href="#">Index</a>	<a href="#">Index</a> position to insert the item at.

#### Return value

= 0      on success  
 ≠ 0      on error.

#### Additional information

See [ICONVIEW\\_AddBitmapItem\(\)](#) for screenshots. The pointer to the bitmap stream needs to remain valid.



### 7.2.13.5.1.20 ICONVIEW\_OwnerDraw()

#### Description

Default function for drawing a ICONVIEW widget.

#### Prototype

```
int ICONVIEW_OwnerDraw(const WIDGET_ITEM_DRAW_INFO * pDrawItemInfo);
```

#### Parameters

Parameter	Description
<code>pDrawItemInfo</code>	Pointer to a WIDGET_ITEM_DRAW_INFO structure.

#### Return value

Returns 0.

#### Additional information

This function is useful if `ICONVIEW_SetOwnerDraw()` has been used. It can be used from the custom drawing routine for managing all not handled commands. For more information please refer to `ICONVIEW_SetOwnerDraw()` on page 1633.

### 7.2.13.5.1.21 ICONVIEW\_SetBitmapItem()

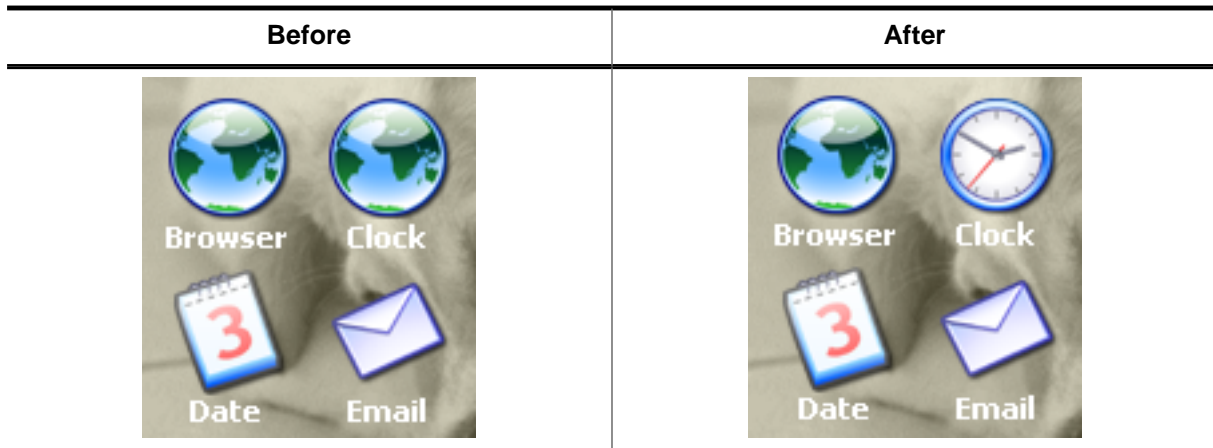

#### Description

Sets a bitmap to be used by a specific item.

#### Prototype

```
int ICONVIEW_SetBitmapItem(    ICONVIEW_Handle  hObj,
                              int                    Index,
                              const GUI_BITMAP      * pBitmap);
```

#### Parameters

Parameter	Description
<code>hObj</code>	Handle of ICONVIEW widget.
<code>Index</code>	<code>Index</code> of the item.
<code>pBitmap</code>	Pointer to the bitmap to be used.

#### Return value

Returns 0.

#### Additional information

The pointer to the bitmap structure needs to remain valid.

### 7.2.13.5.1.22 ICONVIEW\_SetBkColor()

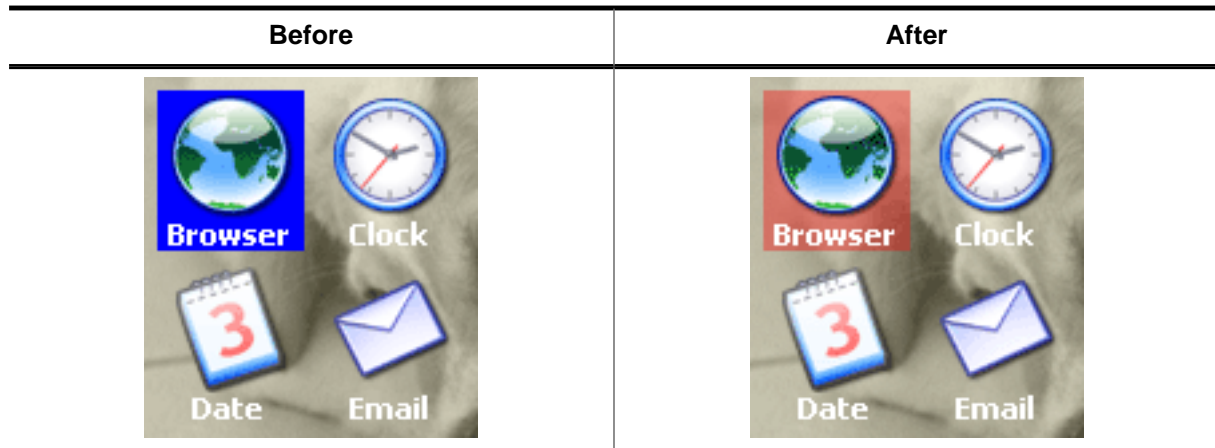

#### Description

Sets the background color of the widget.

#### Prototype

```
void ICONVIEW_SetBkColor(ICONVIEW_Handle hObj,
                        int Index,
                        GUI_COLOR Color);
```

#### Parameters

Parameter	Description
<code>hObj</code>	Handle of ICONVIEW widget.
<code>Index</code>	See <i>ICONVIEW color indexes</i> on page 1642 for a full list of permitted values.
<code>Color</code>	<code>Color</code> to be used for drawing the background.

#### Additional information

The upper 8 bits of the 32 bit color value can be used for an alpha blending effect. For more details about alpha blending, refer to `GUI_SetAlpha()`.

### 7.2.13.5.1.23 ICONVIEW\_SetFont()

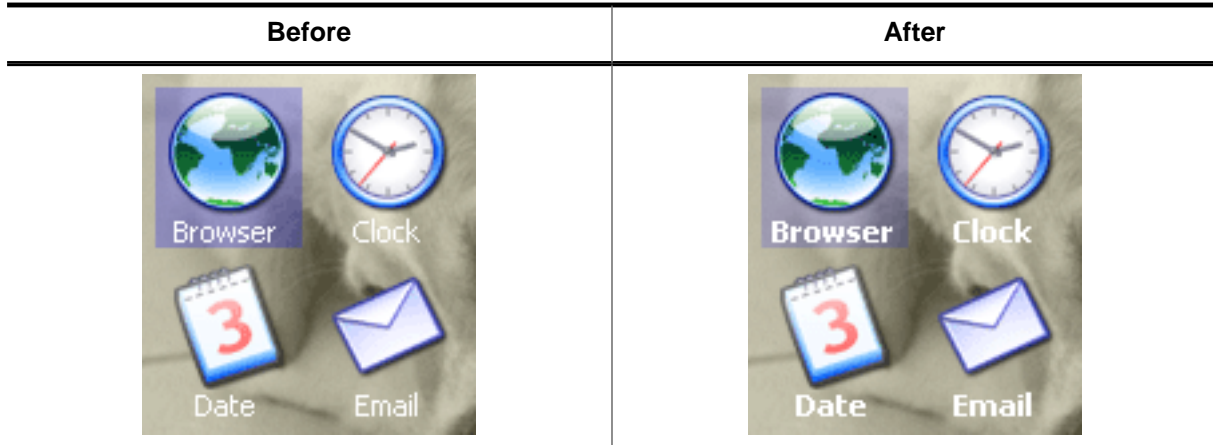

#### Description

Sets the font to be used for drawing the icon labels.

#### Prototype

```
void ICONVIEW_SetFont(    ICONVIEW_Handle  hObj,
                        const GUI_FONT    * pFont);
```

#### Parameters

Parameter	Description
<a href="#">hObj</a>	Handle of ICONVIEW widget.
<a href="#">pFont</a>	Pointer to a GUI_FONT structure to be used to draw the icon labels.

### 7.2.13.5.1.24 ICONVIEW\_SetFrame()

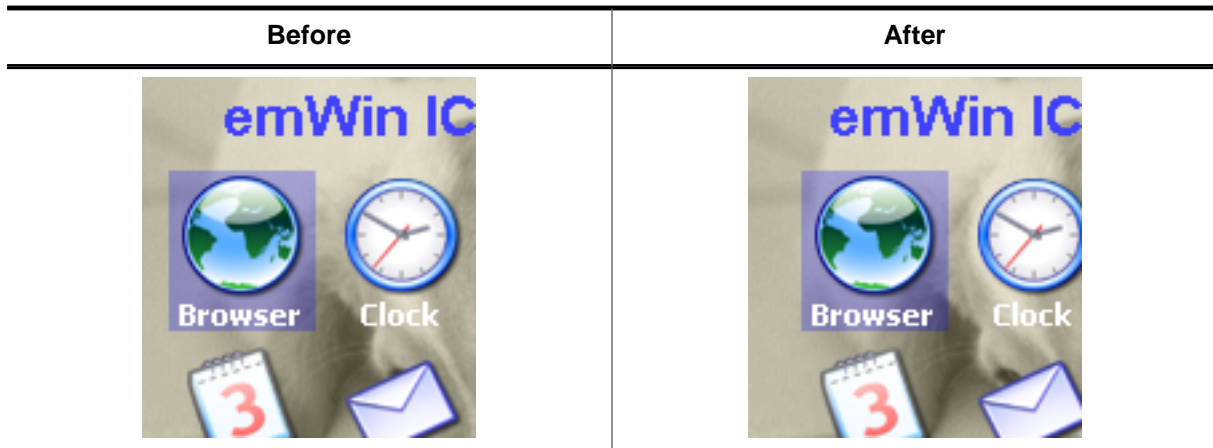

#### Description

Sets the size of the frame between the border of the widget and the icons.

#### Prototype

```
void ICONVIEW_SetFrame(ICONVIEW_Handle hObj,
                       int Coord,
                       int Value);
```

#### Parameters

Parameter	Description
<code>hObj</code>	Handle of ICONVIEW widget.
<code>Coord</code>	See permitted values for this parameter below.
<code>Value</code>	Distance to be set.

Permitted values for parameter <code>Coord</code>	
<code>GUI_COORD_X</code>	X-direction.
<code>GUI_COORD_Y</code>	Y-direction.

### 7.2.13.5.1.25 ICONVIEW\_SetIconAlign()

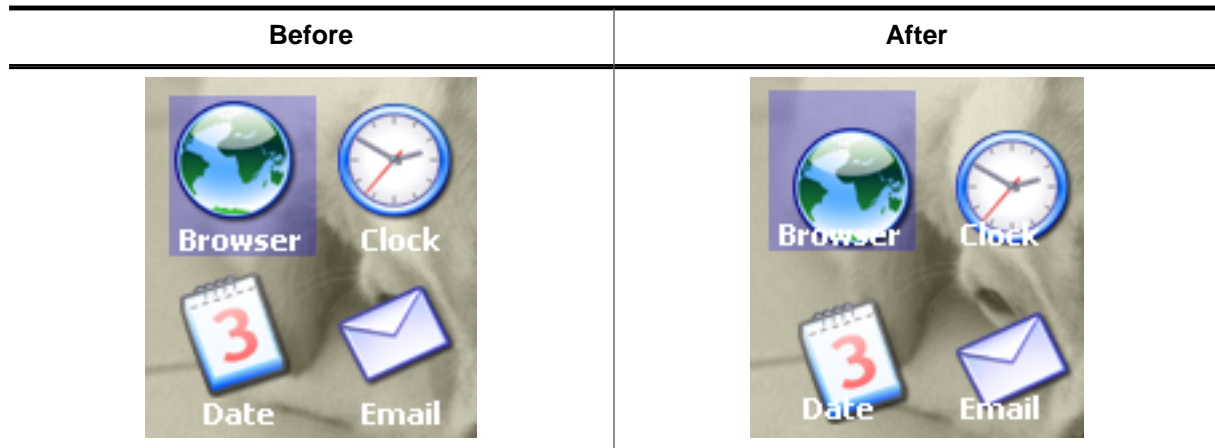

#### Description

Sets the icon alignment.

#### Prototype

```
void ICONVIEW_SetIconAlign(ICONVIEW_Handle hObj,
                           int             IconAlign);
```

#### Parameters

Parameter	Description
<code>hObj</code>	Handle of ICONVIEW widget.
<code>IconAlign</code>	Alignment of the icons. See <i>ICONVIEW alignment flags</i> on page 1641.

### 7.2.13.5.1.26 ICONVIEW\_SetItemText()

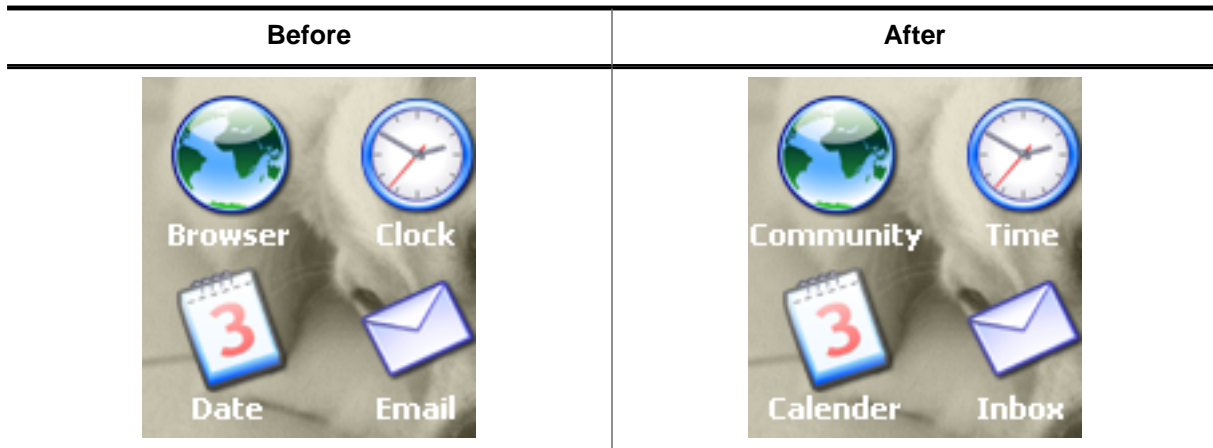

#### Description

Sets the text of a specific item.

#### Prototype

```
void ICONVIEW_SetItemText(    ICONVIEW_Handle  hObj,
                             int                Index,
                             const char        * s);
```

#### Parameters

Parameter	Description
<code>hObj</code>	Handle of ICONVIEW widget.
<code>Index</code>	<code>Index</code> of the item.
<code>pText</code>	Pointer to the text to be used.

### 7.2.13.5.1.27 ICONVIEW\_SetItemUserData()

#### Description

Stores user data in a specific item.

#### Prototype

```
void ICONVIEW_SetItemUserData(ICONVIEW_Handle hObj,  
                             int Index,  
                             U32 UserData);
```

#### Parameters

Parameter	Description
<a href="#">hObj</a>	Handle of ICONVIEW widget.
<a href="#">Index</a>	<a href="#">Index</a> of the item.
<a href="#">UserData</a>	32 bit user data to be stored.



### 7.2.13.5.1.28 ICONVIEW\_SetOwnerDraw()

#### Description

Sets an application defined owner draw function for the widget which is responsible for drawing the widget.

#### Prototype

```
void ICONVIEW_SetOwnerDraw(ICONVIEW_Handle      hObj,
                          WIDGET_DRAW_ITEM_FUNC * pfDrawItem);
```

#### Parameters

Parameter	Description
<code>hObj</code>	Handle of ICONVIEW widget.
<code>pfOwnerDraw</code>	Pointer to owner draw function.

#### Supported commands

- WIDGET\_ITEM\_CREATE
- WIDGET\_DRAW\_BACKGROUND
- WIDGET\_ITEM\_DRAW\_BACKGROUND
- WIDGET\_ITEM\_DRAW\_BITMAP
- WIDGET\_ITEM\_DRAW\_TEXT

#### Additional information

This function sets a pointer to an application defined function which will be called by the widget when a data item has to be drawn or when the x or y size of a item is needed. `pfDrawItem` is a pointer to an application-defined function of type `WIDGET_DRAW_ITEM_FUNC` which is explained at the beginning of the chapter.

#### Example

The following example uses a bitmap for drawing the widget background:

```
static int _OwnerDraw(const WIDGET_ITEM_DRAW_INFO * pDrawItemInfo) {
    switch (pDrawItemInfo->Cmd) {
        case WIDGET_DRAW_BACKGROUND:
            GUI_DrawBitmap(&Bitmap, 0, 0);
            break;
        default:
            return ICONVIEW_OwnerDraw(pDrawItemInfo);
    }
    return 0;
}
```

### 7.2.13.5.1.29 ICONVIEW\_SetSel()

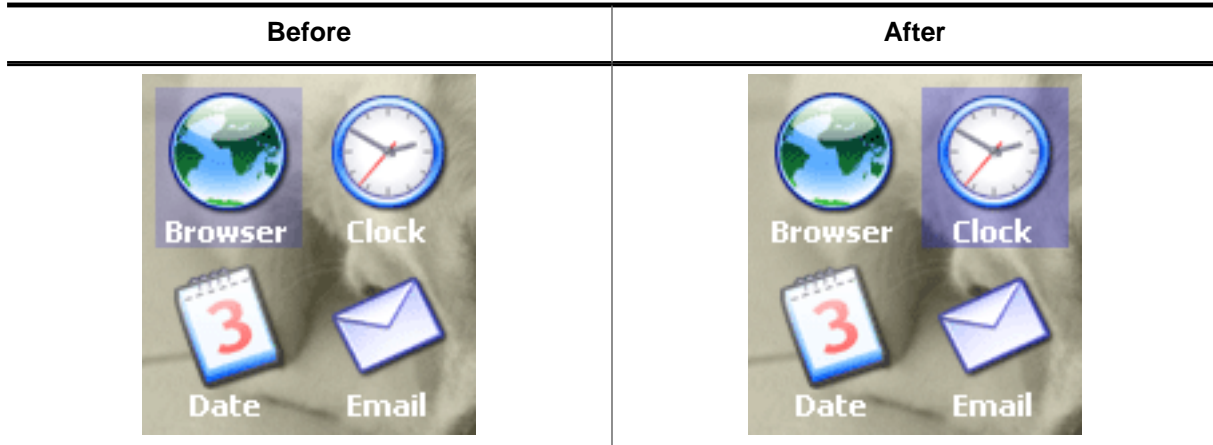

#### Description

Sets the current selection.

#### Prototype

```
void ICONVIEW_SetSel(ICONVIEW_Handle hObj,
                    int Sel);
```

#### Parameters

Parameter	Description
<code>hObj</code>	Handle of ICONVIEW widget.
<code>Sel</code>	New selection.

### 7.2.13.5.1.30 ICONVIEW\_SetSpace()

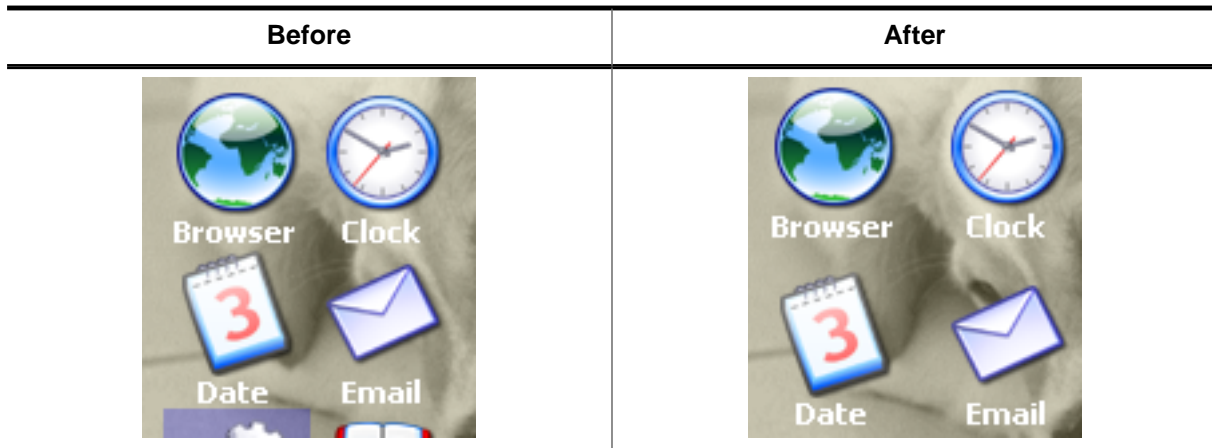

#### Description

Sets the space between icons in x- or y-direction.

#### Prototype

```
void ICONVIEW_SetSpace(ICONVIEW_Handle hObj,
                       int             Coord,
                       int             Value);
```

#### Parameters

Parameter	Description
<code>hObj</code>	Handle of ICONVIEW widget.
<code>Coord</code>	See permitted values for this parameter below.
<code>Value</code>	Distance to be set.

Permitted values for parameter <code>Coord</code>	
<code>GUI_COORD_X</code>	X-direction.
<code>GUI_COORD_Y</code>	Y-direction.

### 7.2.13.5.1.31 ICONVIEW\_SetStreamedBitmapItem()

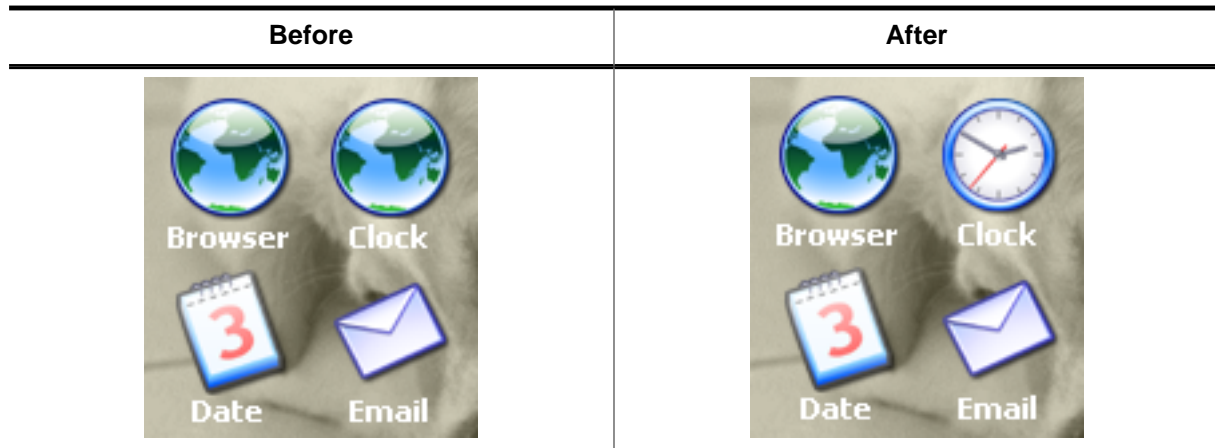

#### Description

Sets a streamed bitmap to be used by a specific item.

#### Prototype

```
int ICONVIEW_SetStreamedBitmapItem(    ICONVIEW_Handle  hObj,
                                       int                Index,
                                       const void          * pStreamedBitmap);
```

#### Parameters

Parameter	Description
<code>hObj</code>	Handle of ICONVIEW widget.
<code>Index</code>	<code>Index</code> of the item.
<code>pStreamedBitmap</code>	Pointer to the bitmap stream to be used.

#### Additional information

The pointer to the bitmap stream needs to remain valid.

### 7.2.13.5.1.32 ICONVIEW\_SetTextAlign()

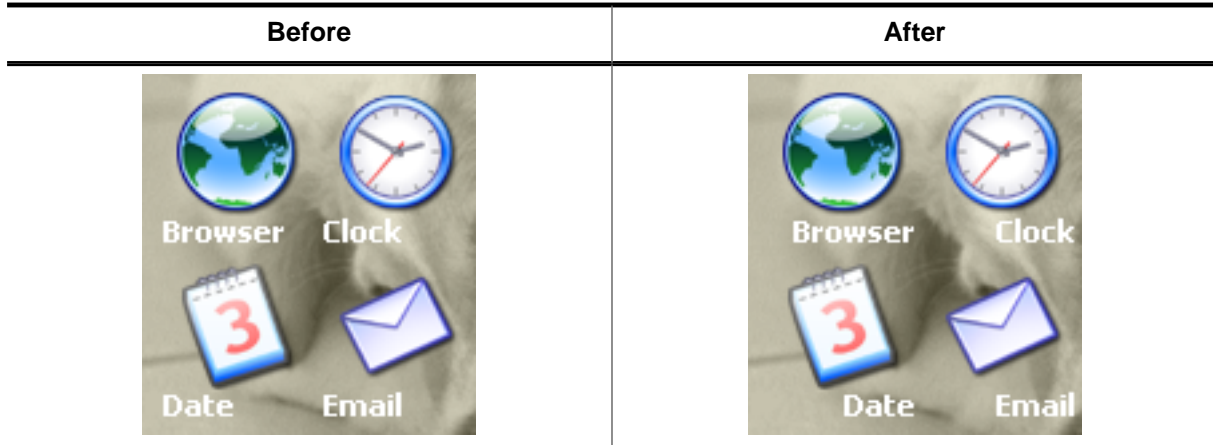

#### Description

Sets the text align of the item texts.

#### Prototype

```
void ICONVIEW_SetTextAlign(ICONVIEW_Handle hObj,
                           int TextAlign);
```

#### Parameters

Parameter	Description
<code>hObj</code>	Handle of ICONVIEW widget.
<code>TextAlign</code>	Text alignment mode. List of flags can be found under <i>Text alignment flags</i> on page 286.

### 7.2.13.5.1.33 ICONVIEW\_SetTextColor()

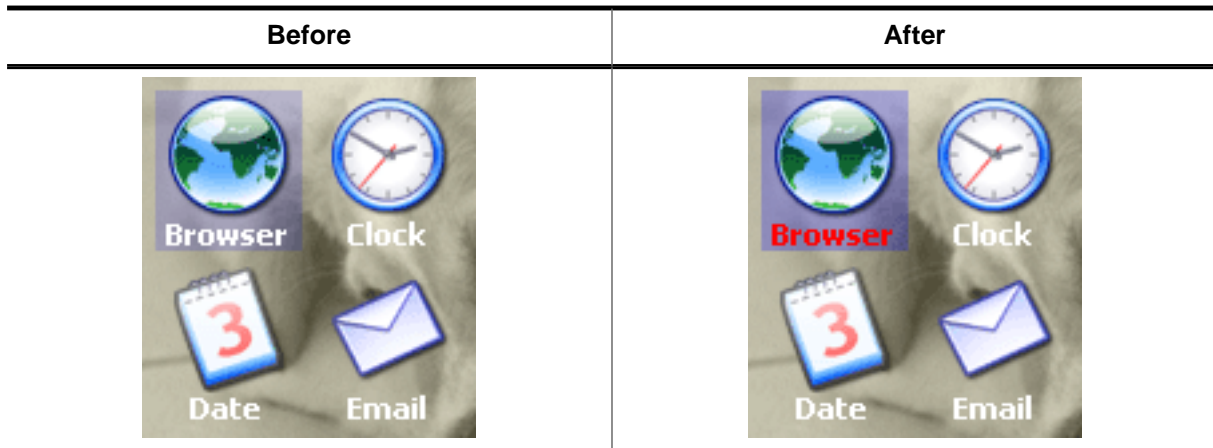

#### Description

Sets the color to be used to draw the labels.

#### Prototype

```
void ICONVIEW_SetTextColor(ICONVIEW_Handle hObj,
                           int           Index,
                           GUI_COLOR     Color);
```

#### Parameters

Parameter	Description
<code>hObj</code>	Handle of <i>ICONVIEW</i> widget.
<code>Index</code>	See <i>ICONVIEW color indexes</i> on page 1642 for a full list of permitted values.
<code>Color</code>	<code>Color</code> to be used

### 7.2.13.5.1.34 ICONVIEW\_SetUserData()

#### Description

Prototype explained at the beginning of the chapter as `<WIDGET>_SetUserData()` on page 1166.

### 7.2.13.5.1.35 ICONVIEW\_SetWrapMode()

#### Description

Sets the wrapping mode to be used for the given ICONVIEW widget.

#### Prototype

```
void ICONVIEW_SetWrapMode(ICONVIEW_Handle hObj,  
                           GUI_WRAPMODE  WrapMode);
```

#### Parameters

Parameter	Description
<a href="#">hObj</a>	Handle of ICONVIEW widget.
<a href="#">WrapMode</a>	See table below.



## 7.2.13.5.2 Defines

### 7.2.13.5.2.1 ICONVIEW alignment flags

#### Description

Alignment flags similar to the Text alignment flags used for aligning the icons of an ICONVIEW widget using the routine `ICONVIEW_SetIconAlign()`. These flags are also OR-combinable.

#### Definition

```
#define ICONVIEW_IA_HCENTER    (0 << 0)
#define ICONVIEW_IA_LEFT      (1 << 0)
#define ICONVIEW_IA_RIGHT     (2 << 0)
#define ICONVIEW_IA_VCENTER   (0 << 2)
#define ICONVIEW_IA_BOTTOM    (1 << 2)
#define ICONVIEW_IA_TOP       (2 << 2)
```

#### Symbols

Definition	Description
Horizontal alignment	
<code>ICONVIEW_IA_LEFT</code>	Align X-position left.
<code>ICONVIEW_IA_HCENTER</code>	Center X-position. (default)
<code>ICONVIEW_IA_RIGHT</code>	Align X-position right.
Vertical alignment	
<code>ICONVIEW_IA_TOP</code>	Align Y-position with top of characters.
<code>ICONVIEW_IA_VCENTER</code>	Center Y-position. (default)
<code>ICONVIEW_IA_BOTTOM</code>	Align Y-position with bottom pixel line of font.

### 7.2.13.5.2 ICONVIEW color indexes

#### Description

Color indexes used by the ICONVIEW widget.

#### Definition

```
#define ICONVIEW_CI_BK          0
#define ICONVIEW_CI_UNSEL     0
#define ICONVIEW_CI_SEL       1
#define ICONVIEW_CI_DISABLED  2
```

#### Symbols

Definition	Description
<a href="#">ICONVIEW_CI_BK</a>	Color used to draw the widget background.
<a href="#">ICONVIEW_CI_UNSEL</a>	Color of an unselected item.
<a href="#">ICONVIEW_CI_SEL</a>	Color of a selected item.
<a href="#">ICONVIEW_CI_DISABLED</a>	Color used in disabled state.

#### Additional information

[ICONVIEW\\_CI\\_BK](#) is only used by the routines `ICONVIEW_GetBkColor()` and `ICONVIEW_SetBkColor()` instead of `ICONVIEW_CI_UNSEL`.

### 7.2.13.5.2.3 ICONVIEW create flags

#### Description

Create flags for the ICONVIEW widget. These flags can be passed to `ICONVIEW_CreateEx()` via the `ExFlags` parameter.

#### Definition

```
#define ICONVIEW_CF_AUTOSCROLLBAR_V    (1 << 1)
```

#### Symbols

Definition	Description
<code>ICONVIEW_CF_AUTOSCROLLBAR_V</code>	A vertical scroll bar will be added if the widget area is too small to show all icons.

### 7.2.13.6 Example

The `Sample` folder contains the following example which shows how the widget can be used:

- `WIDGET_IconView.c`

**Screenshot of `WIDGET_Iconview.c`:**

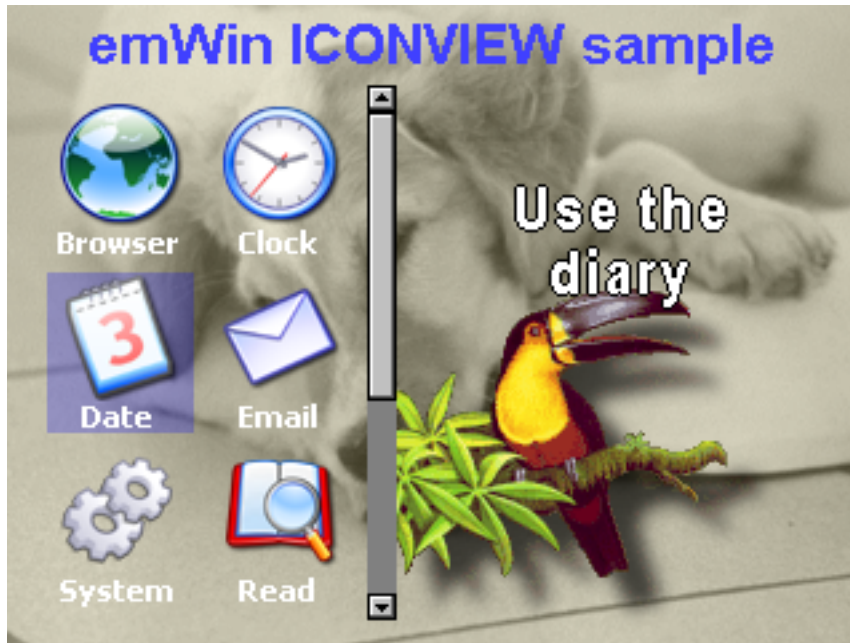

## 7.2.14 IMAGE: Image widget

IMAGE widgets are used to display images of different formats from internal as well as from external memory.

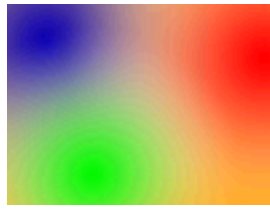

### Note

All IMAGE-related routines are located in the file(s) `IMAGE*.c`, `IMAGE.h`. All identifiers are prefixed `IMAGE`.

### 7.2.14.1 Configuration options

The IMAGE widget can be configured using an OR-combination of flags as `ExFlags`-parameter at creation. A full list of flags can be found under *IMAGE create flags* on page 1663.

### 7.2.14.2 Predefined IDs

The following symbols define IDs which may be used to make IMAGE widgets distinguishable from creation.

```
#define GUI_ID_IMAGE0      0x270
#define GUI_ID_IMAGE1      0x271
#define GUI_ID_IMAGE2      0x272
#define GUI_ID_IMAGE3      0x273
#define GUI_ID_IMAGE4      0x274
#define GUI_ID_IMAGE5      0x275
#define GUI_ID_IMAGE6      0x276
#define GUI_ID_IMAGE7      0x277
#define GUI_ID_IMAGE8      0x278
#define GUI_ID_IMAGE9      0x279
```

### 7.2.14.3 Notification codes

The following events are sent from an IMAGE widget to its parent window as part of a `WM_NOTIFY_PARENT` message:

Message	Description
<code>WM_NOTIFICATION_CLICKED</code>	The widget has been clicked.
<code>WM_NOTIFICATION_RELEASED</code>	The widget has been released.
<code>WM_NOTIFICATION_MOVED_OUT</code>	The pointer was moved out of the widget area while the PID was in pressed state.

## 7.2.14.4 IMAGE API

The table below lists the available IMAGE-related routines in alphabetical order. Detailed descriptions of the routines follow.

### Functions

Routine	Description
<a href="#">IMAGE_CreateEx()</a>	Creates an IMAGE widget.
<a href="#">IMAGE_CreateIndirect()</a>	Creates a IMAGE widget from a resource table entry.
<a href="#">IMAGE_CreateUser()</a>	Creates a IMAGE widget using extra bytes as user data.
<a href="#">IMAGE_EnableLQ()</a>	Enables low-quality mode for the IMAGE widget.
<a href="#">IMAGE_GetImageSize()</a>	Returns the X- and Y-size of the image set to the widget.
<a href="#">IMAGE_GetUserData()</a>	Retrieves the data set with <a href="#">IMAGE_SetUserData()</a> .
<a href="#">IMAGE_SetAlign()</a>	Sets an alignment to the widget's image.
<a href="#">IMAGE_SetAlpha()</a>	Blends the image with an alpha value.
<a href="#">IMAGE_SetAngle()</a>	Rotates the image by a given angle.
<a href="#">IMAGE_SetBitmap()</a>	Sets a bitmap to be displayed.
<a href="#">IMAGE_SetBMP()</a>	Sets a BMP file to be displayed.
<a href="#">IMAGE_SetBMPEX()</a>	Sets a BMP file to be displayed from external memory.
<a href="#">IMAGE_SetDTA()</a>	Sets a DTA file to be displayed.
<a href="#">IMAGE_SetDTAEX()</a>	Sets a DTA file to be displayed from external memory.
<a href="#">IMAGE_SetGIF()</a>	Sets a GIF file to be displayed.
<a href="#">IMAGE_SetGIFEX()</a>	Sets a GIF file to be displayed from external memory.
<a href="#">IMAGE_SetJPEG()</a>	Sets a JPEG file to be displayed.
<a href="#">IMAGE_SetJPEGEX()</a>	Sets a JPEG file to be displayed from external memory.
<a href="#">IMAGE_SetOffset()</a>	Sets an X- and Y-offset to the widget's image.
<a href="#">IMAGE_SetPNG()</a>	Sets a PNG file to be displayed.
<a href="#">IMAGE_SetPNGEX()</a>	Sets a PNG file to be displayed from external memory.
<a href="#">IMAGE_SetScale()</a>	Scales the image by a given factor.
<a href="#">IMAGE_SetTiled()</a>	Enables tiled mode for an IMAGE widget.
<a href="#">IMAGE_SetUserData()</a>	Sets the extra data of an IMAGE widget.

### Defines

Group of defines	Description
<a href="#">IMAGE_create_flags</a>	Create flags used for IMAGE widgets.

## 7.2.14.4.1 Functions

### 7.2.14.4.1.1 IMAGE\_CreateEx()

#### Description

Creates an IMAGE widget of a specified size at a specified location.

#### Prototype

```
IMAGE_Handle IMAGE_CreateEx(int    x0,
                             int    y0,
                             int    xSize,
                             int    ySize,
                             WM_HWIN hParent,
                             int    WinFlags,
                             int    ExFlags,
                             int    Id);
```

#### Parameters

Parameter	Description
<code>x0</code>	Leftmost pixel of the widget (in parent coordinates).
<code>y0</code>	Topmost pixel of the widget (in parent coordinates).
<code>xSize</code>	Horizontal size of the widget (in pixels).
<code>ySize</code>	Vertical size of the widget (in pixels).
<code>hParent</code>	Handle of parent window. If 0, the IMAGE widget will be a child of the desktop (top-level window).
<code>WinFlags</code>	Window create flags. Typically <code>WM_CF_SHOW</code> in order to make the widget visible immediately (refer to <i>Window create flags</i> on page 1146 for a list of available parameter values).
<code>ExFlags</code>	See <i>IMAGE create flags</i> on page 1663.
<code>Id</code>	Window ID of the widget.

#### Return value

Handle of the created IMAGE widget; 0 if the function fails.

#### Additional information

If the possibility of storing user data is a matter the function `IMAGE_CreateUser()` should be used instead.

### 7.2.14.4.1.2 IMAGE\_CreateIndirect()

#### Description

The prototype of this function is explained at the beginning of this chapter. For details the function `<WIDGET>_CreateIndirect()` on page 1161 should be referred to. The element `Flags` is used according to the parameter `WinFlags` of the function `IMAGE_CreateEx()`. The element `Para` is used according to the parameter `ExFlags` of the function `IMAGE_CreateEx()`. For a detailed description of the parameters the function `IMAGE_CreateEx()` can be referred to.



### 7.2.14.4.1.3 IMAGE\_CreateUser()

#### Description

Prototype explained at the beginning of the chapter as `<WIDGET>_CreateUser()` on page 1162. For a detailed description of the parameters the function `IMAGE_CreateEx()` can be referred to.

#### 7.2.14.4.1.4 IMAGE\_EnableLQ()

##### Description

Enables low-quality mode for the IMAGE widget. This ensures a faster performance for rotating the image with `IMAGE_Rotate()`, but results in a lower image quality.

##### Prototype

```
void IMAGE_EnableLQ(IMAGE_Handle hObj,  
                   int           OnOff);
```

##### Parameters

Parameter	Description
<code>hObj</code>	Handle of IMAGE widget.
<code>OnOff</code>	1 for enabling, 0 for disabling.

### 7.2.14.4.1.5 IMAGE\_GetImageSize()

#### Description

Returns the X- and Y-size of the image set to the widget.

#### Prototype

```
int IMAGE_GetImageSize(IMAGE_Handle hObj,  
                       int          * pxSize,  
                       int          * pySize);
```

#### Parameters

Parameter	Description
<code>hObj</code>	Handle of IMAGE widget.
<code>pxSize</code>	Pointer to an integer to store the X-size.
<code>pySize</code>	Pointer to an integer to store the Y-size.

#### Return value

0        On success.  
1        On error.

#### 7.2.14.4.1.6 IMAGE\_GetUserData()

##### **Description**

Prototype explained at the beginning of the chapter as `<WIDGET>_GetUserData()` on page 1165.

### 7.2.14.4.1.7 IMAGE\_SetAlign()

#### Description

Sets an alignment to the widget's image.

#### Prototype

```
void IMAGE_SetAlign(IMAGE_Handle hObj,  
                   int           Align);
```

#### Parameters

Parameter	Description
<a href="#">hObj</a>	Handle of IMAGE widget.
<a href="#">Align</a>	Alignment of the image.

### 7.2.14.4.1.8 IMAGE\_SetAlpha()

#### Description

Blends the image with an alpha value.

#### Prototype

```
U8 IMAGE_SetAlpha(IMAGE_Handle hObj,  
                  U8           Alpha);
```

#### Parameters

Parameter	Description
<a href="#">hObj</a>	Handle of IMAGE widget.
<a href="#">Alpha</a>	<a href="#">Alpha</a> value (0-255).

#### Return value

Old alpha value.

### 7.2.14.4.1.9 IMAGE\_SetAngle()

#### Description

Rotates the image by a given angle.

#### Prototype

```
int IMAGE_SetAngle(IMAGE_Handle hObj,  
                  unsigned Angle);
```

#### Parameters

Parameter	Description
<a href="#">hObj</a>	Handle of IMAGE widget.
<a href="#">Angle</a>	<a href="#">Angle</a> in degrees * 1000 (e.g. 45000 equals 45°).

#### Return value

Old angle.

#### 7.2.14.4.1.10 IMAGE\_SetBitmap()

##### Description

Sets a bitmap to be displayed.

##### Prototype

```
void IMAGE_SetBitmap(      IMAGE_Handle  hObj,  
                        const GUI_BITMAP * pBitmap);
```

##### Parameters

Parameter	Description
<code>hWin</code>	Handle of IMAGE widget.
<code>pBitmap</code>	Pointer to the bitmap.



**7.2.14.4.1.11 IMAGE\_SetBMP()****7.2.14.4.1.12 IMAGE\_SetDTA()****7.2.14.4.1.13 IMAGE\_SetGIF()****7.2.14.4.1.14 IMAGE\_SetJPEG()****7.2.14.4.1.15 IMAGE\_SetPNG()****Description**

These functions set a file of one of the formats listed below to be displayed:

- BMP
- DTA
- GIF
- JPEG
- PNG

**Prototype**

```
void IMAGE_Set<FORMAT>(      IMAGE_Handle hObj,
                           const void * pData,
                           U32      FileSize);
```

**Parameters**

Parameter	Description
<code>hObj</code>	Handle of IMAGE widget.
<code>pData</code>	Pointer to the IMAGE data.
<code>FileSize</code>	Size of the IMAGE data.

**Additional information**

The PNG functionality requires the PNG library which can be downloaded from [www.segger.com](http://www.segger.com). Animated GIF files are displayed automatically. Please make sure that each sub image of a GIF file replaces the previous one.

With a photo editing tool, such as GIMP, it is possible to convert a GIF file into the proper format. Follow these steps to create such a GIF file with GIMP:

1. Open the GIF file
2. On the menu bar click **Filters → Animation → Unoptimize**
3. Export as GIF

**7.2.14.4.1.16 IMAGE\_SetBMPEX()****7.2.14.4.1.17 IMAGE\_SetDTAEX()****7.2.14.4.1.18 IMAGE\_SetGIFEX()****7.2.14.4.1.19 IMAGE\_SetJPEGEX()****7.2.14.4.1.20 IMAGE\_SetPNGEX()****Description**

These functions set a file of one of the formats listed below to be displayed from external memory:

- BMP
- DTA
- GIF
- JPEG
- PNG

**Prototype**

```
void IMAGE_Set<FORMAT>EX( IMAGE_Handle      hObj,  
                          GUI_GET_DATA_FUNC * pfGetData,  
                          void              * pVoid);
```

**Additional information**

The PNG functionality requires the PNG library which can be downloaded from [www.segger.com](http://www.segger.com). Animated GIF files are displayed automatically.

### 7.2.14.4.1.21 IMAGE\_SetOffset()

#### Description

Sets an X- and Y-offset to the widget's image.

#### Prototype

```
void IMAGE_SetOffset(IMAGE_Handle hObj,  
                    int           xOff,  
                    int           yOff);
```

#### Parameters

Parameter	Description
<code>hObj</code>	Handle of IMAGE widget.
<code>xOff</code>	X-offset set to image.
<code>yOff</code>	Y-offset set to image.

### 7.2.14.4.1.22 IMAGE\_SetScale()

#### Description

Scales the image by a given factor.

#### Prototype

```
int IMAGE_SetScale(IMAGE_Handle hObj,  
                  unsigned      Scale);
```

#### Parameters

Parameter	Description
<code>hObj</code>	Handle of IMAGE widget.
<code>Scale</code>	Factor * 1000 (e.g. 2000 equals 200% scale)

#### Return value

Old scale value.

### 7.2.14.4.1.23 IMAGE\_SetTiled()



#### Description

Enables tiled mode for an IMAGE widget. With tiled mode, the entire area of the widget is filled with the set image, even if the image is smaller than the widget area.

#### Prototype

```
void IMAGE_SetTiled(IMAGE_Handle hObj,
                   int           OnOff);
```

#### Parameters

Parameter	Description
hObj	Handle of IMAGE widget.
OnOff	1 for enabling tiled mode, 0 for disabling it.

#### 7.2.14.4.1.24 IMAGE\_SetUserData()

##### **Description**

Prototype explained at the beginning of the chapter as `<WIDGET>_SetUserData()` on page 1166.

## 7.2.14.4.2 Defines

### 7.2.14.4.2.1 IMAGE create flags

#### Description

Create flags for the IMAGE widget. These flags can be passed to `ICONVIEW_CreateEx()` via the `ExFlags` parameter.

#### Definition

```
#define IMAGE_CF_MEMDEV      (1 << 0)
#define IMAGE_CF_TILE       (1 << 1)
#define IMAGE_CF_ALPHA      (1 << 2)
#define IMAGE_CF_ATTACHED   (1 << 3)
#define IMAGE_CF_AUTOSIZE   (1 << 4)
#define IMAGE_CF_LQ         (1 << 5)
```

#### Symbols

Definition	Description
<code>IMAGE_CF_MEMDEV</code>	Makes the IMAGE widget use an internal Memory Device for drawing. Contrary to the Memory Device which is created by the Window Manager's automatic use of Memory Devices ( <code>WM_CF_MEMDEV</code> ), this device stays valid all the time. It has to be ensured that the emWin memory pool which is defined by the function <code>GUI_ALLOC_AssignMemory()</code> (in <code>GUIConf.c</code> ), is big enough to store the complete data. If the Memory Device can not be created, the image is drawn directly. This might possibly mean loss of performance.
<code>IMAGE_CF_TILE</code>	Uses tiling to fill up the whole area of the widget.
<code>IMAGE_CF_ALPHA</code>	Needs to be set if alpha blending is required (PNG).
<code>IMAGE_CF_ATTACHED</code>	Widget size is fixed to the parent border.
<code>IMAGE_CF_AUTOSIZE</code>	Widget size is taken from the attached image.
<code>IMAGE_CF_LQ</code>	Fast mode (lower quality) should be used for rotating/scaling.

## 7.2.15 KEYBOARD: Keyboard widget

The KEYBOARD widget offers a fully configurable screen keyboard to enter characters. With more and more embedded targets having touch screens and using smartphone-like interfaces, the KEYBOARD widget fits right in being similar in appearance and usage to a typical smartphone keyboard.

To keep the positioning of the individual keys as simple as possible, keys can be added as whole key lines, that are scaled to the size of the widget automatically. The widget also enables the use of long press keys, much like with most smartphone keyboards. This way, it is possible to access even dozens of characters by only pressing one key.

### Note

All KEYBOARD-related routines are located in the file(s) `KEYBOARD.c`, `KEYBOARD.h`.



### 7.2.15.1 Configuration options

Type	Macro	Default	Description
N	KEYBOARD_COLOR_KEY_DEFAULT	GUI_MAKE_COLOR(0x383838)	Color used for keys.
N	KEYBOARD_COLOR_PRESSED_DEFAULT	GUI_GRAY_60	Pressed color of keys.
N	KEYBOARD_COLOR_FKEY_DEFAULT	GUI_MAKE_COLOR(0x262626)	Color of function key, such as shift.
N	KEYBOARD_COLOR_CODE_DEFAULT	GUI_WHITE	Text color of key.
N	KEYBOARD_COLOR_LONG_DEFAULT	GUI_GRAY_AA	Text color of long press character on a key.
N	KEYBOARD_BKCOLOR_DEFAULT	GUI_MAKE_COLOR(0x080808)	Background color of keyboard.
N	KEYBOARD_BKCOLOR_SHIFTLOCK	GUI_MAKE_COLOR(0xFE9741)	Color of shift lock symbol.
N	KEYBOARD_FRAMERADIUS_DEFAULT	3	Radius of frame used for a key.
N	KEYBOARD_FRAMESIZE_DEFAULT	0	Size of frame used for a key.
N	KEYBOARD_SPACEX_DEFAULT	8	Total space in X between the keys.
N	KEYBOARD_SPACEY_DEFAULT	8	Total space in Y between the keys.
N	KEYBOARD_PERIOD_DEFAULT	200	Period for a longpress.
N	KEYBOARD_PERIOD_REPEAT_DEFAULT	50	Period for repeated actions, such as holding the backspace key.



## 7.2.15.2 Predefined IDs

The following symbols define IDs which may be used to make KEYBOARD widgets distinguishable from creation.

```
#define GUI_ID_KEYBOARD0    0x360
#define GUI_ID_KEYBOARD1    0x361
#define GUI_ID_KEYBOARD2    0x362
#define GUI_ID_KEYBOARD3    0x363
#define GUI_ID_KEYBOARD4    0x364
#define GUI_ID_KEYBOARD5    0x365
#define GUI_ID_KEYBOARD6    0x366
#define GUI_ID_KEYBOARD7    0x367
#define GUI_ID_KEYBOARD8    0x368
#define GUI_ID_KEYBOARD9    0x369
```

## 7.2.15.3 Keyboard reaction





The widget can not gain the input focus and does not react on keyboard input.

## 7.2.15.4 Predefined keyboard layouts

To make the usage of the widget easier, some keyboard layout have already been defined for this widget. Refer to `KEYBOARD_SetLayout()` to learn how to set a layout to a KEYBOARD widget.

### Note

Some of the predefined layouts come in a simplified version and an advanced version with additional long press characters. The long press versions are marked with an `..._LP` suffix.

Layout	Screenshot	Description
KEYBOARD_ARA		Layout used for Arabic.
KEYBOARD_DEU KEYBOARD_DEU_LP		QWERTZ layout, used for German.
KEYBOARD_ENG KEYBOARD_ENG_LP		QWERTY layout, used for the English language.
KEYBOARD_FRA_LP		AZERTY layout, main layout used for the French language.

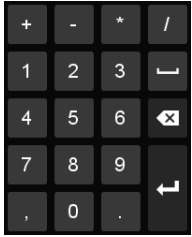
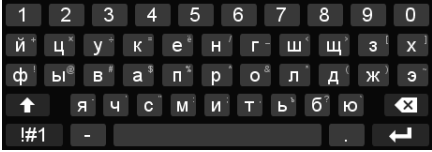
Layout	Screenshot	Description
KEYBOARD_NUMPAD		Numpad layout.
KEYBOARD_RUS		ЙЦУКЕН/ЙЦУКЕИ layout, main Cyrillic keyboard layout for the Russian language.

### 7.2.15.5 Structure and definition of the widget

A KEYBOARD widget consists of a number of keys. Most keys (letters and numbers) are added to the keyboard via the definition of a key line. Keys can also be added individually and their appearance can be defined via text or using a bitmap.

The code of the predefined keyboard layouts can be taken as reference if a custom layout is desired.

#### 7.2.15.5.1 Key lines

Lines of keys can be defined and added to a keyboard, for example a line of characters would be QWERTYUIOP. With key lines, each key does not have to be added individually. Nor does each key have to be positioned and sized individually. The size and position of each key is calculated from the position and size of a key line.

A key line can be defined using the KEYDEF\_LINE structure.

#### Fixed key lines

Fixed key lines are key lines that remain unchanged when the shift key or the switch key is pressed. An example for this in the QWERTY layout would be the first line that contains the numbers 0 to 9.

Key lines	Fixed key line
	

#### 7.2.15.5.2 Keys

##### Shift key

A shift key is used to change between lower case key lines and upper case key lines.



A shift key is defined using the `KEYDEF_SHIFT` structure. The key has four states: normal (default), shift (one press), shift locked (two presses) and an extra state (three presses). The appearance of the states can be defined by passing an array of `KEYDEF_BUTTON` structures. Each `KEYDEF_BUTTON` element points to a bitmap. Alternatively, text can be added in order for it to be displayed on the key.

```
static const KEYDEF_SHIFT _KeyShift = { { 0, 600, 120, 200 },
    { NULL, &_acShift0_16x16, sizeof(_acShift0_16x16) },
    { NULL, &_acShift0_16x16, sizeof(_acShift1_16x16) },
    { NULL, &_acShift0_16x16, sizeof(_acShift0_16x16) },
    { NULL, NULL, 0 } };
```

## Switch key

A switch key is used to change between lower/upper case key lines and extra key lines. Extra key lines are intended to be used for special characters.

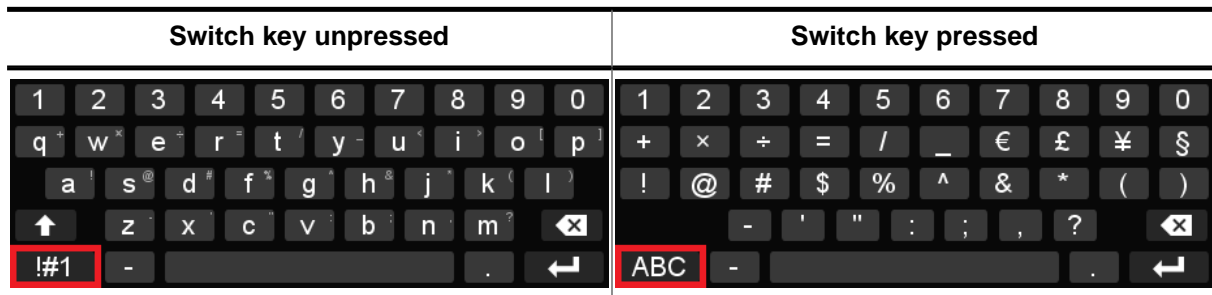

A switch key is defined using the `KEYDEF_SWITCH` structure. The key has two states: normal (default) and switched (one press). Just like for the shift key, the appearance of each state can be defined by passing an array of `KEYDEF_BUTTON` structures. Each element can either point to a bitmap or a string.

```
static const KEYDEF_SWITCH _KeySwitch = { { 0, 800, 150, 200 }, { { "!#1", NULL, 0 },
    { "ABC", NULL, 0 } } };
```

## Other keys

Any other keys that are not a part of a key line are added to the keyboard using the `KEYDEF_KEY` structure. The position and size must be specified first using the `KEYDEF_AREA` structure. Then the character code that the key should print is specified. The last structure member is of the type `KEYDEF_BUTTON` to define the appearance of the key.

```
static const KEYDEF_KEY _KeyBackspace = { { 880, 600, 120, 200 }, // Position and size of
    // key in promille
    0x0008, // Code (for KEYDEF_KEY only)
    { NULL, // Text
      &_acBackspace_24x16, // Pointer to streamed bitmap
    // or bitmap structure
    sizeof(_acBackspace_24x16) // Size of streamed bitmap
    } };
```

### 7.2.15.5.3 Long press characters

When an additional character or multiple additional characters have been set for a key, they can be accessed by performing a long press. This behavior is very much alike to the one of a smartphone keyboard.

The first character in the list of long press characters will be shown in small in the upper right corner of the key. If multiple long press characters are set, a dialog will open. The dialog shows all available long press characters. The user is able to select a character by holding the press and moving to the left or to the right.

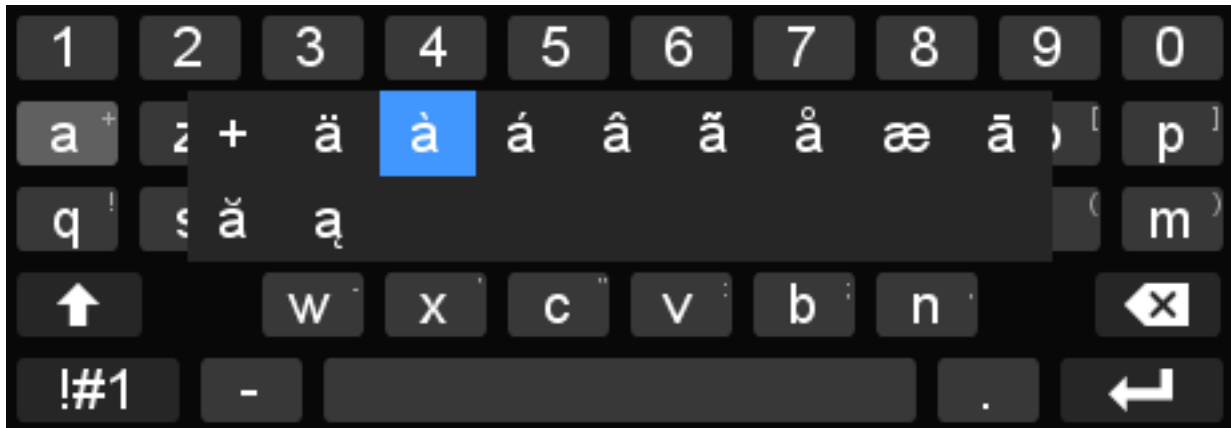

### 7.2.15.6 Import and export of layouts

The KEYBOARD widget also offers the possibility to export and import layouts. The layouts are saved as a .skbd file and have to be stored in accessible memory (RAM or ROM).

#### Import of layouts

Layouts can be imported using the routine `KEYBOARD_SetStreamedLayout()`. The API description also offers an example implementation using the Windows API.

#### Export of layouts

Layouts can be exported using the routine `KEYBOARD_ExportLayout()`. The API description also offers an example implementation using the Windows API.

## 7.2.15.7 KEYBOARD API

The table below lists the available emWin KEYBOARD-related routines in alphabetical order. Detailed descriptions of the routines follow.

### Functions

Routine	Description
<a href="#">KEYBOARD_CreateUser()</a>	Creates a new KEYBOARD widget.
<a href="#">KEYBOARD_CreateIndirect()</a>	Creates a KEYBOARD widget from a resource table entry.
<a href="#">KEYBOARD_ExportLayout()</a>	Exports a KEYBOARD layout to an .skbd file.
<a href="#">KEYBOARD_ExportPatternFile()</a>	Exports a font pattern file for a given KEYBOARD layout.
<a href="#">KEYBOARD_GetDefaultColor()</a>	Returns the default color of the KEYBOARD widget.
<a href="#">KEYBOARD_GetDefaultFrameSize()</a>	Returns the default frame size of the KEYBOARD widget.
<a href="#">KEYBOARD_GetDefaultPeriod()</a>	Returns the default period of the KEYBOARD widget.
<a href="#">KEYBOARD_GetDefaultRadius()</a>	Returns the default frame radius of the KEYBOARD widget.
<a href="#">KEYBOARD_GetDefaultSpace()</a>	Returns the default space of the KEYBOARD widget.
<a href="#">KEYBOARD_GetKeyRect()</a>	Used to retrieve the rectangle area of a key with the given Unicode code point.
<a href="#">KEYBOARD_LockShiftState()</a>	Locks the state of the shift key.
<a href="#">KEYBOARD_SetLayout()</a>	Sets a layout to a KEYBOARD widget.
<a href="#">KEYBOARD_SetStreamedLayout()</a>	Sets a streamed layout from an external .skbd file to a KEYBOARD widget.
<a href="#">KEYBOARD_SetColor()</a>	Sets the color of a KEYBOARD widget.
<a href="#">KEYBOARD_SetDefaultColor()</a>	Sets a default color for newly created KEYBOARD widgets.
<a href="#">KEYBOARD_SetDefaultFrameSize()</a>	Sets a default frame size for newly created KEYBOARD widgets.
<a href="#">KEYBOARD_SetDefaultPeriod()</a>	Sets a default period for newly created KEYBOARD widgets.
<a href="#">KEYBOARD_SetDefaultRadius()</a>	Sets a default radius for newly created KEYBOARD widgets.
<a href="#">KEYBOARD_SetDefaultSpace()</a>	Sets a default space for newly created KEYBOARD widgets.
<a href="#">KEYBOARD_SetFont()</a>	Sets a font to the KEYBOARD widget.
<a href="#">KEYBOARD_SetPeriod()</a>	Sets the period of a KEYBOARD widget.
<a href="#">KEYBOARD_SetRadius()</a>	Sets the radius of the keys of a KEYBOARD widget.
<a href="#">KEYBOARD_SetShiftState()</a>	Sets the state of the shift key.
<a href="#">KEYBOARD_SetSpace()</a>	Sets the space between the keys of a KEYBOARD widget.

### Data structures

Structure	Description
<a href="#">KEYDEF_KEYBOARD</a>	Configuration structure to define the entire layout of a KEYBOARD widget.

Structure	Description
<a href="#">KEYBOARD_CODES</a>	Structure that is used for storing pointers to arrays of long press characters.
<a href="#">KEYDEF_AREA</a>	This structure is used to define the position and size of keys on the keyboard.
<a href="#">KEYDEF_KEY</a>	Structure that defines a single key to be used in a keyboard.
<a href="#">KEYDEF_SHIFT</a>	Configuration structure to define a shift key for the keyboard.
<a href="#">KEYDEF_SWITCH</a>	Configuration structure to define a switch key for the keyboard.
<a href="#">KEYDEF_BUTTON</a>	Structure that holds information about how a key should look like.
<a href="#">KEYDEF_LINE</a>	Structure that defines one line of characters of a keyboard.

## Defines

Group of defines	Description
<a href="#">KEYBOARD color indexes</a>	Color indexes used for KEYBOARD widgets.
<a href="#">KEYBOARD font indexes</a>	Font indexes used for KEYBOARD widgets.
<a href="#">KEYBOARD period indexes</a>	Period indexes used for KEYBOARD widgets.

## 7.2.15.7.1 Functions

### 7.2.15.7.1.1 KEYBOARD\_CreateUser()

#### Description

Creates a new KEYBOARD widget.

#### Prototype

```
KEYBOARD_Handle KEYBOARD_CreateUser(    int           x0,
                                          int           y0,
                                          int           xSize,
                                          int           ySize,
                                          WM_HWIN      hParent,
                                          int           WinFlags,
                                          int           ExFlags,
                                          const KEYDEF_KEYBOARD * pKeyboard,
                                          int           Id,
                                          int           NumExtraBytes);
```

#### Parameters

Parameter	Description
<code>x0</code>	Leftmost pixel of the KEYBOARD (in parent coordinates).
<code>y0</code>	Topmost pixel of the KEYBOARD (in parent coordinates).
<code>xSize</code>	Horizontal size of the KEYBOARD (in pixels).
<code>ySize</code>	Vertical size of the KEYBOARD (in pixels).
<code>hParent</code>	Handle of parent window.
<code>WinFlags</code>	Window create flags. Typically <code>WM_CF_SHOW</code> in order to make the widget visible immediately (refer to <i>Window create flags</i> on page 1146 for a list of available parameter values).
<code>ExFlags</code>	Not used yet, reserved for future use.
<code>pKeyboard</code>	Pointer to a data structure of type <code>KEYDEF_KEYBOARD</code> which defines the desired layout. Can be zero.
<code>Id</code>	Window ID of the widget.
<code>NumExtraBytes</code>	Number of extra bytes to be allocated for user data.

#### Return value

Handle of the created KEYBOARD widget.

### 7.2.15.7.1.2 KEYBOARD\_CreateIndirect()

#### Description

The prototype of this function is explained at the beginning of this chapter. Details can be found in the description of the function `<WIDGET>_CreateIndirect()` on page . The elements `Flags` and `Para` of the resource passed as parameter are not used.



### 7.2.15.7.1.3 KEYBOARD\_ExportLayout()

#### Description

Exports a KEYBOARD layout to an .skbd file. The exported layout can be stored on external memory and imported using `KEYBOARD_SetStreamedLayout()`.

#### Prototype

```
void KEYBOARD_ExportLayout(      GUI_CALLBACK_VOID_U8_P * pfSerialize,
                                void * pVoid,
                                const KEYDEF_KEYBOARD * pKeyboard);
```

#### Parameters

Parameter	Description
<code>pfSerialize</code>	Pointer to serialization callback function.
<code>pVoid</code>	Pointer to file handle.
<code>pKeyboard</code>	Pointer to a data structure of type <code>KEYDEF_KEYBOARD</code> containing the layout to be exported.

#### Example

Below is a sample implementation that uses the Windows API functions.

```

/*****
 *
 *     _WriteByte2File
 */
static void _WriteByte2File(U8 Data, void * p) {
    HANDLE hFile;
    DWORD  NumBytesWritten;

    hFile = (HANDLE)p;
    WriteFile(hFile, &Data, 1, &NumBytesWritten, NULL);
}

/*****
 *
 *     _StreamLayout
 */
static void _StreamLayout() {
    HANDLE hFile;

    hFile = CreateFile("C:\\Temp\\
\\Layout.skbd", GENERIC_WRITE, 0, 0, CREATE_ALWAYS, FILE_ATTRIBUTE_NORMAL, 0);
    KEYBOARD_ExportLayout(_WriteByte2File, (void *)hFile, &KEYBOARD_ENG);
    CloseHandle(hFile);
}

```

### 7.2.15.7.1.4 KEYBOARD\_ExportPatternFile()

#### Description

Exports a font pattern file for a given KEYBOARD layout. This pattern file can be used when creating a font with the FontConverter for activating all required characters for the layout.

#### Prototype

```
void KEYBOARD_ExportPatternFile(      GUI_CALLBACK_VOID_U8_P * pfSerialize,
                                     void * pVoid,
                                     const KEYDEF_KEYBOARD * pKeyboard);
```

#### Parameters

Parameter	Description
<code>pfSerialize</code>	Pointer to serialization callback function.
<code>pVoid</code>	Pointer to file handle.
<code>pKeyboard</code>	Pointer to a data structure of type <code>KEYDEF_KEYBOARD</code> to be used.

#### Additional information

Information on how to use pattern files with the FontConverter tool can be read under *Pattern files* on page 3153.

### 7.2.15.7.1.5 KEYBOARD\_GetDefaultColor()

#### Description

Returns the default color of the KEYBOARD widget.

#### Prototype

```
GUI_COLOR KEYBOARD_GetDefaultColor(unsigned Index);
```

#### Parameters

Parameter	Description
<a href="#">Index</a>	Color index. Refer to <i>KEYBOARD color indexes</i> on page 1704.

#### Return value

= GUI\_INVALID\_COLOR      On error.  
≠ GUI\_INVALID\_COLOR      Default color for given index.

### 7.2.15.7.1.6 KEYBOARD\_GetDefaultFrameSize()

#### Description

Returns the default frame size of the KEYBOARD widget.

#### Prototype

```
int KEYBOARD_GetDefaultFrameSize(void);
```

#### Return value

Default frame size.

### 7.2.15.7.1.7 KEYBOARD\_GetDefaultPeriod()

#### Description

Returns the default period of the KEYBOARD widget.

#### Prototype

```
unsigned KEYBOARD_GetDefaultPeriod(unsigned Index);
```

#### Parameters

Parameter	Description
<a href="#">Index</a>	Period index. Refer to <i>KEYBOARD period indexes</i> on page 1706.

#### Return value

- = 0      On error.
- ≠ 0     Default period for given index.

### 7.2.15.7.1.8 KEYBOARD\_GetDefaultRadius()

#### Description

Returns the default frame radius of the KEYBOARD widget.

#### Prototype

```
int KEYBOARD_GetDefaultRadius(void);
```

#### Return value

Default frame radius.

### 7.2.15.7.1.9 KEYBOARD\_GetDefaultSpace()

#### Description

Returns the default space of the KEYBOARD widget.

#### Prototype

```
int KEYBOARD_GetDefaultSpace(unsigned Axis);
```

#### Parameters

Parameter	Description
<a href="#">Axis</a>	Desired axis. See <a href="#">Axis values</a> on page 440 for valid values.

#### Return value

- = -1 On error.
- ≠ -1 Default space on given axis.

### 7.2.15.7.1.10 KEYBOARD\_GetKeyRect()

#### Description

Used to retrieve the rectangle area of a key with the given Unicode code point.

#### Prototype

```
int KEYBOARD_GetKeyRect (KEYBOARD_Handle  hObj,
                        GUI_RECT          * pRect,
                        U32                 cKey);
```

#### Parameters

Parameter	Description
<a href="#">hObj</a>	Handle to KEYBOARD widget.
<a href="#">pRect</a>	<b>out</b> Pointer to a GUI_RECT to retrieve the rectangular area.
<a href="#">cKey</a>	Code point of the key.

#### Return value

0        On success.  
1        On error.

#### Additional information

Only the rectangle of visible keys can be retrieved. It might be necessary to switch the mode before retrieving a rectangle.



### 7.2.15.7.1.11 KEYBOARD\_LockShiftState()

#### Description

Locks the state of the shift key.

#### Prototype

```
void KEYBOARD_LockShiftState(KEYBOARD_Handle hObj,  
                             unsigned OnOff);
```

#### Parameters

Parameter	Description
<code>hObj</code>	Handle to KEYBOARD widget.
<code>OnOff</code>	1 - Shift- and switch key are locked, 0 - Shift- and switch key are not locked

### 7.2.15.7.1.12 KEYBOARD\_SetLayout()

#### Description

Sets a layout to a KEYBOARD widget.

#### Prototype

```
int KEYBOARD_SetLayout(      KEYBOARD_Handle  hObj,  
                           const KEYDEF_KEYBOARD * pKeyboard);
```

#### Parameters

Parameter	Description
<code>hObj</code>	Handle to KEYBOARD widget.
<code>pKeyboard</code>	Pointer to a data structure of type <code>KEYDEF_KEYBOARD</code> .

#### Return value

0        On success.  
1        On error.

#### Additional information

A list of predefined layouts can be found under *Predefined keyboard layouts* on page 1665.

#### Example

```
KEYBOARD_SetLayout(hKeyboard, &KEYBOARD_ENG);
```

### 7.2.15.7.1.13 KEYBOARD\_SetStreamedLayout()

#### Description

Sets a streamed layout from an external .skbd file to a KEYBOARD widget.

#### Prototype

```
int KEYBOARD_SetStreamedLayout(    KEYBOARD_Handle  hObj,
                                   const void          * pVoid,
                                   U32                  Size);
```

#### Parameters

Parameter	Description
<code>hObj</code>	Handle to KEYBOARD widget.
<code>pVoid</code>	Pointer to streamed data. The data has to remain valid after the function has been called.
<code>Size</code>	<code>Size</code> of streamed data in bytes.

#### Return value

0        On success.  
1        On error.

#### Example

Below is a sample implementation that uses the Windows API functions.

```
static void _LoadStreamedLayout(void) {
    HANDLE hFile;
    DWORD  FileSize;
    char * pData;
    DWORD  NumBytesRead;

    hFile = CreateFile("C:\\Temp\\
\\Layout.skbd", GENERIC_READ, 0, 0, OPEN_EXISTING, FILE_ATTRIBUTE_NORMAL, 0);
    FileSize = GetFileSize(hFile, NULL);
    pData = (char *)malloc(FileSize);
    ReadFile(hFile, pData, FileSize, &NumBytesRead, NULL);
    CloseHandle(hFile);
    KEYBOARD_SetStreamedLayout(hKeyboard, pData, NumBytesRead);
}
```

Alternatively, the .skbd file can also be converted into an array (using the Bin2C tool) and stored in accessible memory.

```
KEYBOARD_SetStreamedLayout(hKeyboard, _acLayout, sizeof(_acLayout));
```

### 7.2.15.7.1.14 KEYBOARD\_SetColor()

#### Description

Sets the color of a KEYBOARD widget.

#### Prototype

```
void KEYBOARD_SetColor(KEYBOARD_Handle hObj,  
                        unsigned Index,  
                        GUI_COLOR Color);
```

#### Parameters

Parameter	Description
<a href="#">hObj</a>	Handle to KEYBOARD widget.
<a href="#">Index</a>	<a href="#">Color</a> index. Refer to <i>KEYBOARD color indexes</i> on page 1704.
<a href="#">Color</a>	<a href="#">Color</a> to use for specified index.

### 7.2.15.7.1.15 KEYBOARD\_SetDefaultColor()

#### Description

Sets a default color for newly created KEYBOARD widgets.

#### Prototype

```
void KEYBOARD_SetDefaultColor(unsigned Index,  
                               GUI_COLOR Color);
```

#### Parameters

Parameter	Description
<a href="#">Index</a>	<a href="#">Color</a> index. Refer to <i>KEYBOARD color indexes</i> on page 1704.
<a href="#">Color</a>	New default color.

### 7.2.15.7.1.16 KEYBOARD\_SetDefaultFrameSize()

#### Description

Sets a default frame size for newly created KEYBOARD widgets.

#### Prototype

```
void KEYBOARD_SetDefaultFrameSize(int FrameSize);
```

#### Parameters

Parameter	Description
FrameSize	New default frame size.

### 7.2.15.7.1.17 KEYBOARD\_SetDefaultPeriod()

#### Description

Sets a default period for newly created KEYBOARD widgets.

#### Prototype

```
void KEYBOARD_SetDefaultPeriod(unsigned Index,  
                               unsigned Period);
```

#### Parameters

Parameter	Description
<a href="#">Index</a>	<a href="#">Period</a> index. Refer to <i>KEYBOARD period indexes</i> on page 1706.
<a href="#">Period</a>	New default period.

### 7.2.15.7.1.18 KEYBOARD\_SetDefaultRadius()

#### Description

Sets a default radius for newly created KEYBOARD widgets.

#### Prototype

```
void KEYBOARD_SetDefaultRadius(int Radius);
```

#### Parameters

Parameter	Description
Radius	New default radius.



### 7.2.15.7.1.19 KEYBOARD\_SetDefaultSpace()

#### Description

Sets a default space for newly created KEYBOARD widgets.

#### Prototype

```
void KEYBOARD_SetDefaultSpace(unsigned Axis,  
                               int      Space);
```

#### Parameters

Parameter	Description
<a href="#">Axis</a>	Desired axis. See <a href="#">Axis values</a> on page 440 for valid values.
<a href="#">Space</a>	New default space.

### 7.2.15.7.1.20 KEYBOARD\_SetFont()

#### Description

Sets a font to the KEYBOARD widget.

#### Prototype

```
void KEYBOARD_SetFont(      KEYBOARD_Handle  hObj,  
                           unsigned          Index,  
                           const GUI_FONT    * pFont );
```

#### Parameters

Parameter	Description
<a href="#">hObj</a>	Handle to KEYBOARD widget.
<a href="#">Index</a>	Font index. Refer to <i>KEYBOARD font indexes</i> on page 1705.
<a href="#">pFont</a>	Font to be used.

### 7.2.15.7.1.21 KEYBOARD\_SetPeriod()

#### Description

Sets the period of a KEYBOARD widget. The period can be for long pressing a key or holding a key (such as backspace), depending on the period index.

#### Prototype

```
void KEYBOARD_SetPeriod(KEYBOARD_Handle hObj,  
                        unsigned Index,  
                        unsigned Period);
```

#### Parameters

Parameter	Description
<a href="#">hObj</a>	Handle to KEYBOARD widget.
<a href="#">Index</a>	<a href="#">Period</a> index. Refer to <i>KEYBOARD period indexes</i> on page 1706.
<a href="#">Period</a>	New period to use.

### 7.2.15.7.1.22 KEYBOARD\_SetRadius()

#### Description

Sets the radius of the keys of a KEYBOARD widget.

#### Prototype

```
void KEYBOARD_SetRadius(KEYBOARD_Handle hObj,  
                        unsigned Radius);
```

#### Parameters

Parameter	Description
<a href="#">hObj</a>	Handle to KEYBOARD widget.
<a href="#">Radius</a>	New radius to be used.

### 7.2.15.7.1.23 KEYBOARD\_SetShiftState()

#### Description

Sets the state of the shift key.

#### Prototype

```
void KEYBOARD_SetShiftState(KEYBOARD_Handle hObj,  
                             unsigned State);
```

#### Parameters

Parameter	Description
<a href="#">hObj</a>	Handle to KEYBOARD widget.
<a href="#">State</a>	New state to be used.

### 7.2.15.7.1.24 KEYBOARD\_SetSpace()

#### Description

Sets the space between the keys of a KEYBOARD widget.

#### Prototype

```
void KEYBOARD_SetSpace(KEYBOARD_Handle hObj,  
                        unsigned        Axis,  
                        unsigned        Space);
```

#### Parameters

Parameter	Description
<a href="#">hObj</a>	Handle to KEYBOARD widget.
<a href="#">Axis</a>	Desired axis. See <a href="#">Axis values</a> on page 440 for valid values.
<a href="#">Space</a>	New space to be used used.

## 7.2.15.7.2 Data structures

### 7.2.15.7.2.1 KEYDEF\_KEYBOARD

#### Description

Configuration structure to define the entire layout of a KEYBOARD widget. A pointer to a filled structure of this type can be passed to `KEYBOARD_SetLayout()` or `KEYBOARD_CreateUser()`.

If any keyboard components are not needed for the layout, such as certain keys or shift lines etc., `NULL` can be passed instead.

#### Type definition

```
typedef struct {
    const char          * pLongName;
    const KEYDEF_KEY    * pDefBackspace;
    const KEYDEF_KEY    * pDefEnter;
    const KEYDEF_KEY    * pDefSpace;
    const KEYDEF_SHIFT  * pDefShift;
    const KEYDEF_SWITCH * pDefSwitch;
    unsigned            NumFixedLines;
    unsigned            NumCodesLines;
    unsigned            NumShiftLines;
    unsigned            NumExtraLines;
    const KEYDEF_LINE  ** ppLineFixed;
    const KEYDEF_LINE  ** ppLineCodes;
    const KEYDEF_LINE  ** ppLineShift;
    const KEYDEF_LINE  ** ppLineExtra;
    unsigned            wLong;
    unsigned            hLong;
} KEYDEF_KEYBOARD;
```

#### Structure members

Member	Description
<code>pLongName</code>	Name of the layout. The name is only used by AppWizard, therefore the pointer can be <code>NULL</code> .
<code>pDefBackspace</code>	Pointer to key definition of backspace key.
<code>pDefEnter</code>	Pointer to key definition of enter key.
<code>pDefSpace</code>	Pointer to key definition of space key.
<code>pDefShift</code>	Pointer to the definition structure of the shift key.
<code>pDefSwitch</code>	Pointer to the definition structure of the switch key.
<code>NumFixedLines</code>	Number of fixed lines of characters in the keyboard that will not be affected by the shift or switch key.
<code>NumCodesLines</code>	Number of lines of characters in the keyboard that are shown when neither shift nor switch has been pressed.
<code>NumShiftLines</code>	Number of lines of characters to be shown when the shift key has been pressed.
<code>NumExtraLines</code>	Number of lines of characters to be shown when the switch key has been pressed.
<code>ppLineFixed</code>	Pointer to an array of definition structures for the fixed lines of characters.
<code>ppLineCodes</code>	Pointer to an array of definition structures for the lines shown by default.
<code>ppLineShift</code>	Pointer to an array of definition structures for the lines shown when the shift key is pressed.

Member	Description
<code>ppLineExtra</code>	Pointer to an array of definition structures for the lines shown when the switch key is pressed.
<code>wLong</code>	Width of a long press key in the long press dialog. The size is specified in promille and relative to the KEYBOARD widget's size.
<code>hLong</code>	Height of a long press key in the long press dialog. The size is specified in promille and relative to the KEYBOARD widget's size.

## Example

```

const KEYDEF_KEYBOARD_KEYBOARD_ENG = {
    //
    // Long name
    //
    _acLongName,
    //
    // Special keys...
    //
    &_KeyBackspace,
    &_KeyEnter,
    &_KeySpace,
    &_KeyShift,
    &_KeySwitch,
    //
    // Numbers of key lines...
    //
    GUI_COUNTOF(_apLineFixed),
    GUI_COUNTOF(_apLineCodes),
    GUI_COUNTOF(_apLineShift),
    GUI_COUNTOF(_apLineExtra),
    //
    // Pointers to key lines...
    //
    _apLineFixed,
    _apLineCodes,
    _apLineShift,
    _apLineExtra,
    //
    // Size of longpress key
    //
    80, // Width in promille of keyboard's x-size
    200, // Height in promille of keyboard's y-size
};

```



### 7.2.15.7.2.2 KEYBOARD\_CODES

#### Description

Structure that is used for storing pointers to arrays of long press characters.

#### Type definition

```
typedef struct {
    unsigned    NumCodes;
    const U16 * pCodes;
} KEYBOARD_CODES;
```

#### Structure members

Member	Description
<code>NumCodes</code>	Number of characters.
<code>pCodes</code>	Pointer to an array of character codes.

#### Example

```
static const U16 _aLong21_00[] = { 0x002d, 0x0179, 0x017b, 0x017d };
static const U16 _aLong21_01[] = { 0x0027 };
static const U16 _aLong21_02[] = { 0x0022, 0x00c7, 0x0106, 0x010c };
static const KEYBOARD_CODES _aLong21[] = {
    { GUI_COUNTOF(_aLong21_00), _aLong21_00 },
    { GUI_COUNTOF(_aLong21_01), _aLong21_01 },
    { GUI_COUNTOF(_aLong21_02), _aLong21_02 },
};
```

The pointer to the array containing pointers to the long press arrays is then passed as last member of the `KEYDEF_LINE` structure.

```
static const KEYDEF_LINE _AlphaUpper2 = { { 150, 600, 700, 200 },
    { GUI_COUNTOF(_aAlphaUpper2), _aAlphaUpper2 },
    _aLong21 };
```

### 7.2.15.7.2.3 KEYDEF\_AREA

#### Description

This structure is used to define the position and size of keys on the keyboard.

#### Type definition

```
typedef struct {  
    unsigned x;  
    unsigned y;  
    unsigned w;  
    unsigned h;  
} KEYDEF_AREA;
```

#### Structure members

Member	Description
<code>x</code>	X-position.
<code>y</code>	Y-position.
<code>w</code>	Width.
<code>h</code>	Height.

#### Additional information

All positions and sizes are entered in promille. This way, the sizes and positions are relative to the keyboard's window size.

For example, if the width of a key line is defined as 1000, that means the line will span over the entire keyboard widget, since 1000‰ equals 100%. If the keyboard widget has an `x`-size of 400 px, the line will also have an `x`-size of 400.

### 7.2.15.7.2.4 KEYDEF\_KEY

#### Description

Structure that defines a single key to be used in a keyboard.

#### Type definition

```
typedef struct {
    const KEYDEF_AREA    Area;
    U16                  Code;
    const KEYDEF_BUTTON  Button;
} KEYDEF_KEY;
```

#### Structure members

Member	Description
<a href="#">Area</a>	Pointer to data structure of type <code>KEYDEF_AREA</code> that defines the position and size of the key.
<a href="#">Code</a>	Character code that is inserted when the key is pressed.
<a href="#">Button</a>	Pointer to data structure of type <code>KEYDEF_BUTTON</code> that defines the appearance of the key.

#### Example

```
static const KEYDEF_KEY _KeyBackspace = { { 880, 600, 120, 200 }, // Position and size of
                                          // key in promille
                                          0x0008, // Code (for KEYDEF_KEY only)
                                          { NULL, // Text
                                            &_acBackspace_24x16, // Pointer to streamed bitmap
                                                                  // or bitmap structure
                                            sizeof(_acBackspace_24x16) // Size of streamed bitmap
                                          } };
```

### 7.2.15.7.2.5 KEYDEF\_SHIFT

#### Description

Configuration structure to define a shift key for the keyboard. A shift key is used to switch between lower and upper case letters.

#### Type definition

```
typedef struct {
    const KEYDEF_AREA    Area;
    const KEYDEF_BUTTON  aButton[];
} KEYDEF_SHIFT;
```

#### Structure members

Member	Description
<code>Area</code>	Data structure of type <code>KEYDEF_AREA</code> that defines position and size of the shift key.
<code>aButton</code>	Array of type <code>KEYDEF_BUTTON</code> that holds the definition of appearance of four states. The four states are: normal, shift, shift locked and extra.

#### Example

```
static const KEYDEF_SHIFT _KeyShift = { { 0, 600, 120, 200 },
    { { NULL, &_amp;_acShift0_16x16, sizeof(_amp;_acShift0_16x16) },
      { NULL, &_amp;_acShift0_16x16, sizeof(_amp;_acShift1_16x16) },
      { NULL, &_amp;_acShift0_16x16, sizeof(_amp;_acShift0_16x16) },
      { NULL, NULL, 0 } } };
```

### 7.2.15.7.2.6 KEYDEF\_SWITCH

#### Description

Configuration structure to define a switch key for the keyboard. A switch key is used to switch between different lines of characters, mostly used for switching between letters and special characters.

#### Type definition

```
typedef struct {  
    const KEYDEF_AREA    Area;  
    const KEYDEF_BUTTON  aButton[];  
} KEYDEF_SWITCH;
```

#### Structure members

Member	Description
<a href="#">Area</a>	Data structure of type <code>KEYDEF_AREA</code> that defines position and size of the switch key.
<a href="#">aButton</a>	Array of type <code>KEYDEF_BUTTON</code> that holds the appearance definition for pressed and unpressed state.

#### Example

```
static const KEYDEF_SWITCH _KeySwitch = { { { 0, 800, 150, 200 },  
                                           { { "#1", NULL, 0 },  
                                           { "ABC", NULL, 0 } } } };
```

### 7.2.15.7.2.7 KEYDEF\_BUTTON

#### Description

Structure that holds information about how a key should look like. This structure is used by `KEYDEF_KEY`, `KEYDEF_SHIFT` and `KEYDEF_SWITCH`.

#### Type definition

```
typedef struct {
    const char * pText;
    const void * pBm;
    U32          Size;
} KEYDEF_BUTTON;
```

#### Structure members

Member	Description
<code>pText</code>	Pointer to text shown for the key.
<code>pBm</code>	Pointer to streamed bitmap shown for the key.
<code>Size</code>	Array size of streamed bitmap.

#### Additional information

The streamed bitmap should ideally contain a compressed alpha channel (type: "Alpha channel, compressed"). This is necessary so the given shift color can be applied to the key bitmap.

#### Note

Either a text or a bitmap can be set for a key, this means either the pointer `pBm` or `pText` in this structure **must** be `NULL`.

### 7.2.15.7.2.8 KEYDEF\_LINE

#### Description

Structure that defines one line of characters of a keyboard.

#### Type definition

```
typedef struct {
    KEYDEF_AREA          Area;
    KEYBOARD_CODES      Codes;
    const KEYBOARD_CODES * pCodesLong;
} KEYDEF_LINE;
```

#### Structure members

Member	Description
<a href="#">Area</a>	Data structure of type <code>KEYDEF_AREA</code> that defines position and size of the line.
<a href="#">Codes</a>	Data structure of type <code>KEYBOARD_CODES</code> that hold the character codes to be used for the line.
<a href="#">pCodesLong</a>	Pointer to an array of the type <code>KEYBOARD_CODES</code> that holds the character codes for long press. <b>Note:</b> The number of elements in the array <b>must</b> be equal to the number of codes defined in the previous member <a href="#">Codes</a> .

#### Additional information

The given key codes defined in [Codes](#) are spread equally and horizontally over the area defined in the member [Area](#).

#### Example

```
static const KEYDEF_LINE _AlphaUpper2 = { { 150, 600, 700, 200 },
                                           { GUI_COUNTOF(_aAlphaUpper2), _aAlphaUpper2 },
                                           _aLong21 };
```

### 7.2.15.7.3 Defines

#### 7.2.15.7.3.1 KEYBOARD color indexes

##### Description

Color indices for KEYBOARD widget.

##### Definition

```
#define KEYBOARD_CI_KEY           0
#define KEYBOARD_CI_FKEY         1
#define KEYBOARD_CI_PRESSED      2
#define KEYBOARD_CI_CODE         3
#define KEYBOARD_CI_LONG         4
#define KEYBOARD_CI_BK           5
#define KEYBOARD_CI_MARK         6
```

##### Symbols

Definition	Description
<a href="#">KEYBOARD_CI_KEY</a>	Color of key.
<a href="#">KEYBOARD_CI_FKEY</a>	Color of function key, such as shift.
<a href="#">KEYBOARD_CI_PRESSED</a>	Pressed color of a key.
<a href="#">KEYBOARD_CI_CODE</a>	Text color of character on a key.
<a href="#">KEYBOARD_CI_LONG</a>	Text color of long press character on a key.
<a href="#">KEYBOARD_CI_BK</a>	Background color of widget.
<a href="#">KEYBOARD_CI_MARK</a>	Color of shift-lock symbol.



### 7.2.15.7.3.2 KEYBOARD font indexes

#### Description

Font indexes for KEYBOARD widget.

#### Definition

```
#define KEYBOARD_FI_CODE      0
#define KEYBOARD_FI_LONG     1
```

#### Symbols

Definition	Description
<a href="#">KEYBOARD_FI_CODE</a>	Font used for text displayed on a key.
<a href="#">KEYBOARD_FI_LONG</a>	Font used for smaller long press characters displayed on a key.

### 7.2.15.7.3.3 KEYBOARD period indexes

#### Description

Period indices for KEYBOARD widget.

#### Definition



```
#define KEYBOARD_PI_LONGPRESS    0
#define KEYBOARD_PI_REPEAT      1
```

#### Symbols

Definition	Description
<a href="#">KEYBOARD_PI_LONGPRESS</a>	Period it takes for a long press to open the long press dialog.
<a href="#">KEYBOARD_PI_REPEAT</a>	Period for repeated actions, such as holding the backspace key.

## 7.2.16 LISTBOX: List box widget

LISTBOX widgets are used to select one element of a list. A list box can be created without a surrounding frame window, as shown below, or as a child window of a FRAMEWIN widget (see the additional screenshots at the end of the section). As items in a list box are selected, they appear highlighted. Note that the background color of a selected item depends on whether the list box window has input focus.

List box with focus	List box without focus
	

### Note

All LISTBOX-related routines are in the file(s) LISTBOX\*.c, LISTBOX.h.  
All identifiers are prefixed LISTBOX.

### 7.2.16.1 Configuration options

Type	Macro	Default	Description
N	LISTBOX_BKCOLOR0_DEFAULT	GUI_WHITE	Background color, unselected state.
N	LISTBOX_BKCOLOR1_DEFAULT	GUI_GRAY	Background color, selected state without focus.
N	LISTBOX_BKCOLOR2_DEFAULT	GUI_BLUE	Background color, selected state with focus.
S	LISTBOX_FONT_DEFAULT	&GUI_Font13_1	Font used.
N	LISTBOX_TEXTCOLOR0_DEFAULT	GUI_BLACK	Text color, unselected state.
N	LISTBOX_TEXTCOLOR1_DEFAULT	GUI_WHITE	Text color, selected state without focus.
N	LISTBOX_TEXTCOLOR2_DEFAULT	GUI_WHITE	Text color, selected state with focus.

### 7.2.16.2 Predefined IDs

The following symbols define IDs which may be used to make LISTBOX widgets distinguishable from creation.

```
#define GUI_ID_LISTBOX0    0x110
#define GUI_ID_LISTBOX1    0x111
#define GUI_ID_LISTBOX2    0x112
#define GUI_ID_LISTBOX3    0x113
#define GUI_ID_LISTBOX4    0x114
#define GUI_ID_LISTBOX5    0x115
#define GUI_ID_LISTBOX6    0x116
#define GUI_ID_LISTBOX7    0x117
#define GUI_ID_LISTBOX8    0x118
#define GUI_ID_LISTBOX9    0x119
```

### 7.2.16.3 Notification codes

The following events are sent from a LISTBOX widget to its parent window as part of a WM\_NOTIFY\_PARENT message:

Message	Description
WM_NOTIFICATION_CLICKED	LISTBOX has been clicked.
WM_NOTIFICATION_RELEASED	LISTBOX has been released.

Message	Description
WM_NOTIFICATION_MOVED_OUT	LISTBOX has been clicked and pointer has been moved out of the box without releasing.
WM_NOTIFICATION_SCROLL_CHANGED	The scroll position of the optional scroll bar has been changed.
WM_NOTIFICATION_SEL_CHANGED	The selection of the LISTBOX widget has changed.

## 7.2.16.4 Keyboard reaction

The widget reacts to the following keys if it has the input focus:

Key	Reaction
GUI_KEY_SPACE	If the widget works in multi selection mode this key toggles the state of the current selected item.
GUI_KEY_RIGHT	If the maximum X-size of the list box items is larger than the list box itself this key scrolls the list box content to the left.
GUI_KEY_LEFT	If the maximum X-size of the list box items is larger than the list box itself this key scrolls the list box content to the right.
GUI_KEY_DOWN	Moves the selection bar down.
GUI_KEY_UP	Moves the selection bar up.
GUI_KEY_HOME	Sets the selection to the first item.
GUI_KEY_END	Sets the selection to the last item.
GUI_KEY_PGUP	Moves the selection one page up.
GUI_KEY_PGDOWN	Moves the selection one page down.

## 7.2.16.5 LISTBOX API

The table below lists the available emWin LISTBOX-related routines in alphabetical order. Detailed descriptions of the routines follow.

### Functions

Routine	Description
<a href="#">LISTBOX_AddString()</a>	Adds an item to a LISTBOX widget.
<a href="#">LISTBOX_Clear()</a>	Removes all items from the LISTBOX.
<a href="#">LISTBOX_Create()</a>	Creates a LISTBOX widget. (Obsolete)
<a href="#">LISTBOX_CreateAsChild()</a>	Creates a LISTBOX widget as a child window. (Obsolete)
<a href="#">LISTBOX_CreateEx()</a>	Creates a LISTBOX widget.
<a href="#">LISTBOX_CreateIndirect()</a>	Creates a LISTBOX widget from resource table entry.
<a href="#">LISTBOX_CreateUser()</a>	Creates a LISTBOX widget using extra bytes as user data.
<a href="#">LISTBOX_DecSel()</a>	Decrements selection.
<a href="#">LISTBOX_DeleteItem()</a>	Deletes an element.
<a href="#">LISTBOX_EnableMotion()</a>	Enables motion support for the given LISTBOX widget.
<a href="#">LISTBOX_EnableWrapMode()</a>	Enables scrolling from the end to the beginning and vice versa.
<a href="#">LISTBOX_GetBkColor()</a>	Returns the background color of the widget.

Routine	Description
<code>LISTBOX_GetDefaultBkColor()</code>	Returns the default background color for new LISTBOX widgets.
<code>LISTBOX_GetDefaultFont()</code>	Returns the default font used for creating LISTBOX widgets.
<code>LISTBOX_GetDefaultScrollStepH()</code>	Returns the default horizontal scroll step used for creating LISTBOX widgets.
<code>LISTBOX_GetDefaultTextAlign()</code>	Returns the default text alignment for new LISTBOX widgets.
<code>LISTBOX_GetDefaultTextColor()</code>	Returns the default text color for new LISTBOX widgets.
<code>LISTBOX_GetFixedScrollPos()</code>	Returns the currently set fixed scroll position value in pixels.
<code>LISTBOX_GetFont()</code>	Returns a pointer to the font used to display the text of the LISTBOX widget.
<code>LISTBOX_GetItemDisabled()</code>	Returns if the given item of the LISTBOX widget has been disabled.
<code>LISTBOX_GetItemSel()</code>	Returns the selection state of the given LISTBOX item.
<code>LISTBOX_GetItemSpacing()</code>	This function returns the distance between the different items of a LISTBOX.
<code>LISTBOX_GetItemText()</code>	Returns the text of the given item of the LISTBOX widget.
<code>LISTBOX_GetMulti()</code>	Returns if the multi selection mode of the given LISTBOX widget is active.
<code>LISTBOX_GetNumItems()</code>	Returns the number of items in a specified LISTBOX widget.
<code>LISTBOX_GetOwner()</code>	Returns the 'owner' of the widget.
<code>LISTBOX_GetScrollStepH()</code>	Returns the horizontal scroll step of the given LISTBOX widget.
<code>LISTBOX_GetSel()</code>	Returns the zero based index of the currently selected item in a specified LISTBOX widget.
<code>LISTBOX_GetTextAlign()</code>	Returns the text alignment of the given LISTBOX widget.
<code>LISTBOX_GetTextColor()</code>	Returns the text color of the widget.
<code>LISTBOX_GetUserData()</code>	Retrieves the data set with <code>LISTBOX_SetUserData()</code> .
<code>LISTBOX_GetVisItemIndices()</code>	Retrieves the index of the first and last visible item.
<code>LISTBOX_IncSel()</code>	Increment the selection of the LISTBOX widget (moves the selection bar of a specified LISTBOX widget down by one item).
<code>LISTBOX_InsertString()</code>	Inserts an element into a LISTBOX widget.
<code>LISTBOX_InvalidateItem()</code>	Invalidates an item of a owner drawn LISTBOX widget.
<code>LISTBOX_IsItemPartiallyVisible()</code>	Returns if an item of the LISTBOX is partially visible, fully visible or not visible at all.
<code>LISTBOX_OwnerDraw()</code>	Default function to handle a LISTBOX entry.
<code>LISTBOX_SetAutoScrollH()</code>	Enables/disables the automatic use of a horizontal scroll bar.

Routine	Description
<code>LISTBOX_SetAutoScrollV()</code>	Enables/disables the automatic use of a vertical scroll bar.
<code>LISTBOX_SetBkColor()</code>	Sets the background color of the LISTBOX widget.
<code>LISTBOX_SetDefaultBkColor()</code>	Sets the default background color for new LISTBOX widgets.
<code>LISTBOX_SetDefaultFont()</code>	Sets the default font used for creating LISTBOX widgets.
<code>LISTBOX_SetDefaultScrollStepH()</code>	Sets the default horizontal scroll step used when creating a LISTBOX widget.
<code>LISTBOX_SetDefaultTextAlign()</code>	Sets the default text alignment for new LISTBOX widgets.
<code>LISTBOX_SetDefaultTextColor()</code>	Sets the default text color for new LISTBOX widgets.
<code>LISTBOX_SetFixedScrollPos()</code>	Enables the fixed scroll mode for the given LISTBOX widget.
<code>LISTBOX_SetFont()</code>	Sets the font of the LISTBOX widget.
<code>LISTBOX_SetItemDisabled()</code>	Modifies the disable state of the given list item of the LISTBOX widget.
<code>LISTBOX_SetItemSel()</code>	Modifies the selection state of the given item of the LISTBOX widget.
<code>LISTBOX_SetItemSpacing()</code>	Sets an additional spacing below the items of a LISTBOX widget.
<code>LISTBOX_SetMulti()</code>	Switches the multi selection mode of a LISTBOX on or off.
<code>LISTBOX_SetOwnerDraw()</code>	Sets the LISTBOX widget to be owner drawn.
<code>LISTBOX_SetScrollbarColor()</code>	Sets the colors of the optional scroll bar.
<code>LISTBOX_SetScrollbarWidth()</code>	Sets the width of the scroll bars used by the given LISTBOX widget.
<code>LISTBOX_SetScrollStepH()</code>	Sets the horizontal scroll step of the given LISTBOX widget.
<code>LISTBOX_SetSel()</code>	Sets the selected item of a specified LISTBOX widget.
<code>LISTBOX_SetString()</code>	Sets the content of the given item.
<code>LISTBOX_SetTextAlign()</code>	The function sets the text alignment used to display each item of the LISTBOX widget.
<code>LISTBOX_SetTextColor()</code>	Sets the text color of the LISTBOX widget.
<code>LISTBOX_SetUserData()</code>	Sets the extra data of a LISTBOX widget.

## Defines

Group of defines	Description
<code>LISTBOX color indexes</code>	Color indexes used by the LISTBOX widget.
<code>LISTBOX fixed scroll mode flags</code>	Defines used for the fixed scroll mode of the widget.

## 7.2.16.5.1 Functions

### 7.2.16.5.1.1 LISTBOX\_AddString()

#### Description

Adds an item to an already existing LISTBOX widget.

#### Prototype

```
void LISTBOX_AddString(    LISTBOX_Handle  hObj,  
                          const char    * s);
```

#### Parameters

Parameter	Description
<code>hObj</code>	Handle of LISTBOX widget.
<code>s</code>	Text to display.

### 7.2.16.5.1.2 LISTBOX\_Clear()

#### Description

Removes all items from the LISTBOX.

#### Prototype

```
void LISTBOX_Clear(LISTBOX_Handle hObj);
```

#### Parameters

Parameter	Description
<a href="#">hObj</a>	Handle to a LISTBOX widget.



### 7.2.16.5.1.3 LISTBOX\_Create()

#### Note

This function is **deprecated**, `LISTBOX_CreateEx()` should be used instead.

#### Description

Creates a LISTBOX widget of a specified size at a specified location.

#### Prototype

```
LISTBOX_Handle LISTBOX_Create(const GUI_ConstString * ppText,
                             int x0,
                             int y0,
                             int xSize,
                             int ySize,
                             int Flags);
```

#### Parameters

Parameter	Description
<code>ppText</code>	Pointer to an array of string pointers containing the elements to be displayed.
<code>x0</code>	Leftmost pixel of the LISTBOX widget (in parent coordinates).
<code>y0</code>	Topmost pixel of the LISTBOX widget (in parent coordinates).
<code>xSize</code>	Horizontal size of the LISTBOX widget (in pixels).
<code>ySize</code>	Vertical size of the LISTBOX widget (in pixels).
<code>Flags</code>	Window create flags. Typically <code>WM_CF_SHOW</code> in order to make the widget visible immediately (refer to <i>Window create flags</i> on page 1146 for a list of available parameter values).

#### Return value

Handle of the created LISTBOX widget; 0 if the function fails.

#### Additional information

If the parameter `ySize` is greater than the required space for drawing the content of the widget, the y-size will be reduced to the required value. The same applies to the `xSize` parameter.

### 7.2.16.5.1.4 LISTBOX\_CreateAsChild()

#### Note

This function is **deprecated**, `LISTBOX_CreateEx()` should be used instead.

#### Description

Creates a LISTBOX widget as a child window.

#### Prototype

```
LISTBOX_Handle LISTBOX_CreateAsChild(const GUI_ConstString * ppText,
                                     WM_HWIN          hWinParent,
                                     int                x0,
                                     int                y0,
                                     int                xSize,
                                     int                ySize,
                                     int                Flags);
```

#### Parameters

Parameter	Description
<code>ppText</code>	Pointer to an array of string pointers containing the elements to be displayed.
<code>hParent</code>	Handle of parent window.
<code>x0</code>	X-position of the LISTBOX widget relative to the parent window.
<code>y0</code>	Y-position of the LISTBOX widget relative to the parent window.
<code>xSize</code>	Horizontal size of the LISTBOX widget (in pixels).
<code>ySize</code>	Vertical size of the LISTBOX widget (in pixels).
<code>Flags</code>	Window create flags (see <i>Window create flags</i> on page 1146).

#### Return value

Handle of the created LISTBOX widget; 0 if the function fails.

#### Additional information

If the parameter `ySize` is greater than the space required for drawing the content of the widget, the Y-size will be reduced to the required value. If `ySize` = 0 the Y-size of the widget will be set to the Y-size of the client area from the parent window. The same applies for the `xSize` parameter.

### 7.2.16.5.1.5 LISTBOX\_CreateEx()

#### Description

Creates a LISTBOX widget of a specified size at a specified location.

#### Prototype

```
LISTBOX_Handle LISTBOX_CreateEx(    int        x0,
                                   int        y0,
                                   int        xSize,
                                   int        ySize,
                                   WM_HWIN   hParent,
                                   int        WinFlags,
                                   int        ExFlags,
                                   int        Id,
                                   const GUI_ConstString * ppText);
```

#### Parameters

Parameter	Description
<code>x0</code>	Leftmost pixel of the widget (in parent coordinates).
<code>y0</code>	Topmost pixel of the widget (in parent coordinates).
<code>xSize</code>	Horizontal size of the widget (in pixels).
<code>ySize</code>	Vertical size of the widget (in pixels).
<code>hParent</code>	Handle of parent window. If 0, the new HEADER widget will be a child of the desktop (top-level window).
<code>WinFlags</code>	Window create flags. Typically <code>WM_CF_SHOW</code> in order to make the widget visible immediately (refer to <i>Window create flags</i> on page 1146 for a list of available parameter values).
<code>ExFlags</code>	Not used, reserved for future use.
<code>Id</code>	Window ID of the widget.
<code>ppText</code>	Pointer to an array of string pointers containing the elements to be displayed. The last entry of this array has to be <code>NULL</code> .

#### Return value

Handle of the created LISTBOX widget; 0 if the function fails.

#### Additional information

If an array of string pointers is set as last parameter, please make sure that the last entry in this array is `NULL`.

### 7.2.16.5.1.6 LISTBOX\_CreateIndirect()

#### Description

The prototype of this function is explained at the beginning of this chapter. Details can be found in the description of the function `<WIDGET>_CreateIndirect()` on page 1161. The element `Para` of the according `GUI_WIDGET_CREATE_INFO` structure is not used. The element `Flags` is used according to the parameter `ExFlags` of the function `LISTBOX_CreateEx()`.

### 7.2.16.5.1.7 LISTBOX\_CreateUser()

#### Description

Prototype explained at the beginning of the chapter as `<WIDGET>_CreateUser()` on page 1162. For a detailed description of the parameters the function `LISTBOX_CreateEx()` can be referred to.

### 7.2.16.5.1.8 LISTBOX\_DecSel()

#### Description

Decrement the selection of the LISTBOX widget (moves the selection bar of a specified LISTBOX widget up by one item).

#### Prototype

```
void LISTBOX_DecSel(LISTBOX_Handle hObj);
```

#### Parameters

Parameter	Description
<code>hObj</code>	Handle of LISTBOX widget.

#### Additional information

Note that the numbering of items always starts from the top with a value of 0; therefore, decrementing the selection will actually move the selection one row up.

### 7.2.16.5.1.9 LISTBOX\_DeleteItem()

#### Description

Deletes an element from a LISTBOX widget.

#### Prototype

```
void LISTBOX_DeleteItem(LISTBOX_Handle hObj,  
                        unsigned      Index);
```

#### Parameters

Parameter	Description
<a href="#">hObj</a>	Handle of LISTBOX widget.
<a href="#">Index</a>	Zero-based index of element to be deleted.

### 7.2.16.5.1.10 LISTBOX\_EnableMotion()

#### Description

Enables motion support for the given LISTBOX widget.

#### Prototype

```
void LISTBOX_EnableMotion(LISTBOX_Handle hObj,
                          int           Flags);
```

#### Parameters

Parameter	Description
<a href="#">hObj</a>	Handle of LISTBOX widget.
<a href="#">Flags</a>	See table below.

Permitted values for parameter <a href="#">Flags</a>	
0	Disables motion support.
LISTBOX_CF_MOTION_H	Enables horizontal motion support.
LISTBOX_CF_MOTION_V	Enables vertical motion support.

#### Additional information

If motion support isn't enabled for the window manager, it will be activated automatically.

Note that motion support cannot be used in conjunction with scrollbars. This means that enabling motion support on one axis will remove a scrollbar attached to the same axis.



### 7.2.16.5.1.11 LISTBOX\_EnableWrapMode()

#### Description

Enables scrolling from the end to the beginning and vice versa. That avoids scrolling from the end through the whole content of the list. If for example the last set of items of the LISTBOX are currently visible and the user attempts scrolling to the next element the beginning of the list will be shown.

#### Prototype

```
void LISTBOX_EnableWrapMode(LISTBOX_Handle hObj,  
                             int           OnOff);
```

#### Parameters

Parameter	Description
<code>hObj</code>	Handle of LISTBOX widget.
<code>OnOff</code>	1 for enabling wrap mode, 0 (default) for disabling.

### 7.2.16.5.1.12 LISTBOX\_GetBkColor()

#### Description

Returns the background color of the widget.

#### Prototype

```
GUI_COLOR LISTBOX_GetBkColor(LISTBOX_Handle hObj,  
                             unsigned      Index);
```

#### Parameters

Parameter	Description
<a href="#">hObj</a>	Handle of LISTBOX widget.
<a href="#">Index</a>	See <i>LISTBOX color indexes</i> on page 1772 for a full list of permitted values.

#### Return value

The background color of the given widget.

### 7.2.16.5.1.13 LISTBOX\_GetDefaultBkColor()

#### Description

Returns the default background color for new LISTBOX widgets.

#### Prototype

```
GUI_COLOR LISTBOX_GetDefaultBkColor(unsigned Index);
```

#### Parameters

Parameter	Description
<a href="#">Index</a>	See <i>LISTBOX color indexes</i> on page 1772 for a full list of permitted values.

#### Return value

Default background color for new LISTBOX widgets.

#### 7.2.16.5.1.14 LISTBOX\_GetDefaultFont()

##### Description

Returns the default font used for creating LISTBOX widgets.

##### Prototype

```
GUI_FONT *LISTBOX_GetDefaultFont(void);
```

##### Return value

Pointer to the default font.

### 7.2.16.5.1.15 LISTBOX\_GetDefaultScrollStepH()

#### Description

Returns the default horizontal scroll step used for creating LISTBOX widgets. The horizontal scroll step defines the number of pixels to be scrolled if needed.

#### Prototype

```
int LISTBOX_GetDefaultScrollStepH(void);
```

#### Return value

Default horizontal scroll step.

### 7.2.16.5.1.16 LISTBOX\_GetDefaultTextAlign()

#### Description

Returns the default text alignment for new LISTBOX widgets.

#### Prototype

```
int LISTBOX_GetDefaultTextAlign(void);
```

#### Return value

Default text alignment for new LISTBOX widgets.

#### Additional information

For more information, refer to LISTBOX\_SetTextAlign().

### 7.2.16.5.1.17 LISTBOX\_GetDefaultTextColor()

#### Description

Returns the default text color for new LISTBOX widgets.

#### Prototype

```
GUI_COLOR LISTBOX_GetDefaultTextColor(unsigned Index);
```

#### Parameters

Parameter	Description
<a href="#">Index</a>	See <i>LISTBOX color indexes</i> on page 1772 for a full list of permitted values.

#### Return value

Default text color for new LISTBOX widgets.

### 7.2.16.5.1.18 LISTBOX\_GetFixedScrollPos()

#### Description

Returns the currently set fixed scroll position value in pixels. It makes sense to use this function to retrieve the fixed scroll position if `LISTBOX_FM_CENTER` was previously used with `LISTBOX_SetFixedScrollPos()`.

#### Prototype

```
U16 LISTBOX_GetFixedScrollPos(LISTBOX_Handle hObj);
```

#### Parameters

Parameter	Description
<code>hObj</code>	Handle of LISTBOX widget.

#### Return value

Currently set fixed scroll position of the LISTBOX.



### 7.2.16.5.1.19 LISTBOX\_GetFont()

#### Description

Returns a pointer to the font used to display the text of the LISTBOX widget.

#### Prototype

```
GUI_FONT *LISTBOX_GetFont(LISTBOX_Handle hObj);
```

#### Parameters

Parameter	Description
<a href="#">hObj</a>	Handle of LISTBOX widget.

#### Return value

Pointer to the font used to display the text of the LISTBOX widget.

### 7.2.16.5.1.20 LISTBOX\_GetItemDisabled()

#### Description

Returns if the given item of the LISTBOX widget has been disabled.

#### Prototype

```
int LISTBOX_GetItemDisabled(LISTBOX_Handle hObj,  
                           unsigned Index);
```

#### Parameters

Parameter	Description
<a href="#">hObj</a>	Handle of LISTBOX widget.
<a href="#">Index</a>	Zero based index of item.

#### Return value

1 if item has been disabled  
0 if not.

### 7.2.16.5.1.21 LISTBOX\_GetItemSel()

#### Description

Returns the selection state of the given LISTBOX item. The selection state of a LISTBOX item can be modified in multi selection mode only.

#### Prototype

```
int LISTBOX_GetItemSel(LISTBOX_Handle hObj,  
                      unsigned Index);
```

#### Parameters

Parameter	Description
<code>hObj</code>	Handle of LISTBOX widget.
<code>Index</code>	Zero based index of item.

#### Return value

1 if item has been selected  
0 if not.

### 7.2.16.5.1.22 LISTBOX\_GetItemSpacing()

#### Description

This function returns the distance between the different items of a LISTBOX.

#### Prototype

```
unsigned LISTBOX_GetItemSpacing(LISTBOX_Handle hObj);
```

#### Parameters

Parameter	Description
<a href="#">hObj</a>	Handle of LISTBOX widget.

#### Return value

The distance between the items in pixel.

### 7.2.16.5.1.23 LISTBOX\_GetItemText()

#### Description

Returns the text of the given item of the LISTBOX widget.

#### Prototype

```
void LISTBOX_GetItemText(LISTBOX_Handle hObj,  
                        unsigned Index,  
                        char * pBuffer,  
                        int MaxSize);
```

#### Parameters

Parameter	Description
<a href="#">hObj</a>	Handle of LISTBOX widget.
<a href="#">Index</a>	Zero based item index.
<a href="#">pBuffer</a>	Pointer to buffer to store the item text.
<a href="#">MaxSize</a>	Size of the buffer.

#### Additional information

The function copies the text of the given LISTBOX item into the given buffer.

### 7.2.16.5.1.24 LISTBOX\_GetMulti()

#### Description

Returns if the multi selection mode of the given LISTBOX widget is active.

#### Prototype

```
int LISTBOX_GetMulti(LISTBOX_Handle hObj);
```

#### Parameters

Parameter	Description
<a href="#">hObj</a>	Handle of LISTBOX widget.

#### Additional information

1        if active  
0        if not.

### 7.2.16.5.1.25 LISTBOX\_GetNumItems()

#### Description

Returns the number of items in a specified LISTBOX widget.

#### Prototype

```
unsigned LISTBOX_GetNumItems(LISTBOX_Handle hObj);
```

#### Parameters

Parameter	Description
<a href="#">hObj</a>	Handle of LISTBOX widget.

#### Return value

Number of items in the LISTBOX widget.

### 7.2.16.5.1.26 LISTBOX\_GetOwner()

#### Description

Returns the 'owner' of the widget. If it does not have an 'owner' it returns its parent.

#### Prototype

```
WM_HWIN LISTBOX_GetOwner(LISTBOX_Handle hObj);
```

#### Parameters

Parameter	Description
<a href="#">hObj</a>	Handle of LISTBOX widget.

#### Return value

Owner or parent of the widget.

#### Additional information

A LISTBOX is used to represent the list of a DROPDOWN widget in expanded state. In that case the 'owner' is the DROPDOWN widget.



### 7.2.16.5.1.27 LISTBOX\_GetScrollStepH()

#### Description

Returns the horizontal scroll step of the given LISTBOX widget.

#### Prototype

```
int LISTBOX_GetScrollStepH(LISTBOX_Handle hObj);
```

#### Parameters

Parameter	Description
<a href="#">hObj</a>	Handle of LISTBOX widget.

#### Return value

Horizontal scroll step of the given LISTBOX widget.

### 7.2.16.5.1.28 LISTBOX\_GetSel()

#### Description

Returns the zero based index of the currently selected item in a specified LISTBOX widget. In multi selection mode the function returns the index of the focused element.

#### Prototype

```
int LISTBOX_GetSel(LISTBOX_Handle hObj);
```

#### Parameters

Parameter	Description
<code>hObj</code>	Handle of LISTBOX widget.

#### Return value

Zero-based index of the currently selected item.

#### Additional information

If no element has been selected the function returns -1.

### 7.2.16.5.1.29 LISTBOX\_GetTextAlign()

#### Description

Returns the text alignment of the given LISTBOX widget.

#### Prototype

```
int LISTBOX_GetTextAlign(LISTBOX_Handle hObj);
```

#### Parameters

Parameter	Description
<a href="#">hObj</a>	Handle of LISTBOX widget.

#### Return value

Text alignment of the given LISTBOX widget.

#### Additional information

For more information, refer to [LISTBOX\\_SetTextAlign\(\)](#).

### 7.2.16.5.1.30 LISTBOX\_GetTextColor()

#### Description

Returns the text color of the widget.

#### Prototype

```
GUI_COLOR LISTBOX_GetTextColor(LISTBOX_Handle hObj,  
                               unsigned Index);
```

#### Parameters

Parameter	Description
<a href="#">hObj</a>	Handle of LISTBOX widget.
<a href="#">Index</a>	See <i>LISTBOX color indexes</i> on page 1772 for a full list of permitted values.

#### Return value

The text color of the given widget.

### 7.2.16.5.1.31 LISTBOX\_GetUserData()

#### Description

Prototype explained at the beginning of the chapter as `<WIDGET>_GetUserData()` on page 1165.

### 7.2.16.5.1.32 LISTBOX\_GetVisItemIndices()

#### Description

Retrieves the index of the first and last visible item. The function also returns the total number of visible items.

#### Prototype

```
U32 LISTBOX_GetVisItemIndices(LISTBOX_Handle hObj,
                              int           * pFirst,
                              int           * pLast);
```

#### Parameters

Parameter	Description
<code>hObj</code>	Handle to a LISTBOX widget.
<code>pFirst</code>	<b>out</b> Pointer to an integer that stores the zero-based index of the first visible row of the LISTBOX.
<code>pLast</code>	<b>out</b> Pointer to an integer that stores the zero-based index of the last visible row of the LISTBOX.

#### Return value

= -1     Error.  
 ≠ -1     Number of visible items.

#### Additional information

This function also takes partially visible items into account. By using the function `LISTBOX_IsItemPartiallyVisible()`, it can be checked if a row is only partially visible, fully visible or not visible at all.

### 7.2.16.5.1.33 LISTBOX\_IncSel()

#### Description

Increment the selection of the LISTBOX widget (moves the selection bar of a specified LISTBOX widget down by one item).

#### Prototype

```
void LISTBOX_IncSel(LISTBOX_Handle hObj);
```

#### Parameters

Parameter	Description
<a href="#">hObj</a>	Handle of LISTBOX widget.
<a href="#">Index</a>	See table below.

#### Additional information

Note that the numbering of items always starts from the top with a value of 0; therefore incrementing the selection will actually move the selection one row down.

### 7.2.16.5.1.34 LISTBOX\_InsertString()

#### Description

Inserts an element into a LISTBOX widget.

#### Prototype

```
void LISTBOX_InsertString(    LISTBOX_Handle  hObj,  
                             const char      * s,  
                             unsigned        Index);
```

#### Parameters

Parameter	Description
<a href="#">hObj</a>	Handle of LISTBOX widget.
<a href="#">s</a>	Pointer to string to be inserted.
<a href="#">Index</a>	Zero based index of element to be inserted.



### 7.2.16.5.1.35 LISTBOX\_InvalidateItem()

#### Description

Invalidates an item of a owner drawn LISTBOX widget.

#### Prototype

```
void LISTBOX_InvalidateItem(LISTBOX_Handle hObj,
                           int Index);
```

#### Parameters

Parameter	Description
<a href="#">hObj</a>	Handle of LISTBOX widget.
<a href="#">Index</a>	Zero based index of element to be invalidated or LISTBOX_ALL_ITEMS if all items should be invalidated.

#### Additional information

This function only needs to be called if an item of an owner drawn LISTBOX widget has been changed. If a LISTBOX API function (like `LISTBOX_SetString()`) has been used to modify a LISTBOX item `LISTBOX_InvalidateItem()` does not need to be called. It needs to be called if the user decides, that for example the vertical size of an item has been changed. With other words if no LISTBOX API function has been used to modify the item this function needs to be called.

#### LISTBOX\_ALL\_ITEMS

If all items of a LISTBOX should be invalidated use this define as [Index](#) parameter.

### 7.2.16.5.1.36 LISTBOX\_IsItemPartiallyVisible()

#### Description

Returns if an item of the LISTBOX is partially visible, fully visible or not visible at all.

#### Prototype

```
U32 LISTBOX_IsItemPartiallyVisible(LISTBOX_Handle hObj,  
                                   int Index);
```

#### Parameters

Parameter	Description
<a href="#">hObj</a>	Handle to a LISTBOX widget.
<a href="#">Index</a>	Zero-based index of the row to be checked.

#### Return value

- 1 Item is fully visible.
- 0 Item is not visible at all.
- 1 Item is partially visible.

### 7.2.16.5.1.37 LISTBOX\_OwnerDraw()

#### Description

Default function to handle a LISTBOX entry.

#### Prototype

```
int LISTBOX_OwnerDraw(const WIDGET_ITEM_DRAW_INFO * pDrawItemInfo);
```

#### Parameters

Parameter	Description
<code>pDrawItemInfo</code>	Pointer to a WIDGET_ITEM_DRAW_INFO structure.

#### Additional information

This function is useful if `LISTBOX_SetOwnerDraw()` has been used. It can be used from your drawing function to retrieve the original x size of a LISTBOX entry and/or to display the text of a LISTBOX entry and should be called for all unhandled commands. For more information, refer to the section explaining user drawn widgets, `LISTBOX_SetOwnerDraw()` and to the provided example.

### 7.2.16.5.1.38 LISTBOX\_SetAutoScrollH()

#### Description

Enables/disables the automatic use of a horizontal scroll bar.

#### Prototype

```
void LISTBOX_SetAutoScrollH(LISTBOX_Handle hObj,  
                           int State);
```

#### Parameters

Parameter	Description
<a href="#">hObj</a>	Handle of LISTBOX widget.
<a href="#">OnOff</a>	See table below.

Permitted values for parameter <a href="#">OnOff</a>	
0	Disable automatic use of a horizontal scroll bar.
1	Enable automatic use of a horizontal scroll bar.

#### Additional information

If enabled the LISTBOX widget checks if all elements fits into the LISTBOX widget. If not a horizontal scroll bar will be attached to the window.

### 7.2.16.5.1.39 LISTBOX\_SetAutoScrollV()

#### Description

Enables/disables the automatic use of a vertical scroll bar.

#### Prototype

```
void LISTBOX_SetAutoScrollV(LISTBOX_Handle hObj,  
                           int State);
```

#### Parameters

Parameter	Description
<a href="#">hObj</a>	Handle of LISTBOX widget.
<a href="#">OnOff</a>	See table below.

Permitted values for parameter <a href="#">OnOff</a>	
0	Disable automatic use of a vertical scroll bar.
1	Enable automatic use of a vertical scroll bar.

#### Additional information

If enabled the LISTBOX widget checks if all elements fits into the LISTBOX widget. If not a vertical scroll bar will be added.

### 7.2.16.5.1.40 LISTBOX\_SetBkColor()

#### Description

Sets the background color of the LISTBOX widget.

#### Prototype

```
void LISTBOX_SetBkColor(LISTBOX_Handle hObj,  
                        unsigned      Index,  
                        GUI_COLOR     color);
```

#### Parameters

Parameter	Description
<a href="#">hObj</a>	Handle of LISTBOX widget.
<a href="#">Index</a>	See <i>LISTBOX color indexes</i> on page 1772 for a full list of permitted values.
<a href="#">Color</a>	<a href="#">Color</a> to be set.

### 7.2.16.5.1.41 LISTBOX\_SetDefaultBkColor()

#### Description

Sets the default background color for new LISTBOX widgets.

#### Prototype

```
void LISTBOX_SetDefaultBkColor(unsigned Index,  
                               GUI_COLOR Color);
```

#### Parameters

Parameter	Description
<a href="#">Index</a>	See <i>LISTBOX color indexes</i> on page 1772 for a full list of permitted values.
<a href="#">Color</a>	Desired background color.

### 7.2.16.5.1.42 LISTBOX\_SetDefaultFont()

#### Description

Sets the default font used for creating LISTBOX widgets.

#### Prototype

```
void LISTBOX_SetDefaultFont(const GUI_FONT * pFont);
```

#### Parameters

Parameter	Description
<code>pFont</code>	Pointer to the font.



### 7.2.16.5.1.43 LISTBOX\_SetDefaultScrollStepH()

#### Description

Sets the default horizontal scroll step used when creating a LISTBOX widget.

#### Prototype

```
void LISTBOX_SetDefaultScrollStepH(int Value);
```

#### Parameters

Parameter	Description
Value	Number of pixels to be scrolled.

#### 7.2.16.5.1.44 LISTBOX\_SetDefaultTextAlign()

##### Description

Sets the default text alignment for new LISTBOX widgets.

##### Prototype

```
void LISTBOX_SetDefaultTextAlign(int Align);
```

##### Parameters

Parameter	Description
<a href="#">Align</a>	Default text alignment for new LISTBOX widgets.

##### Additional information

For more information, refer to `LISTBOX_SetTextAlign()`.

### 7.2.16.5.1.45 LISTBOX\_SetDefaultTextColor()

#### Description

Sets the default text color for new LISTBOX widgets.

#### Prototype

```
void LISTBOX_SetDefaultTextColor(unsigned Index,  
                                GUI_COLOR Color);
```

#### Parameters

Parameter	Description
<a href="#">Index</a>	See <i>LISTBOX color indexes</i> on page 1772 for a full list of permitted values.
<a href="#">Color</a>	Desired text color.

### 7.2.16.5.1.46 LISTBOX\_SetFixedScrollPos()

#### Description

Enables the fixed scroll mode for the given LISTBOX widget.

#### Prototype

```
void LISTBOX_SetFixedScrollPos(LISTBOX_Handle hObj,
                               U16           FixedScrollPos,
                               U8           Mode);
```

#### Parameters

Parameter	Description
<code>hObj</code>	Handle of LISTBOX widget.
<code>FixedScrollPos</code>	Scroll position the LISTBOX should be fixed to (in pixels, only used if <code>Mode = LISTBOX_FM_ON</code> ).
<code>Mode</code>	Sets the desired mode. See <i>LISTBOX fixed scroll mode flags</i> on page 1773.

#### Additional information

If `Mode = LISTBOX_FM_CENTER`, a fixed scroll position will be calculated so that the item is in the middle of the widget. The calculated value can be retrieved with `LISTBOX_GetFixedScrollPos()`.

### 7.2.16.5.1.47 LISTBOX\_SetFont()

#### Description

Sets the font of the LISTBOX widget.

#### Prototype

```
void LISTBOX_SetFont(      LISTBOX_Handle  hObj,  
                        const GUI_FONT    * pFont);
```

#### Parameters

Parameter	Description
<code>hObj</code>	Handle of LISTBOX widget.
<code>pFont</code>	Pointer to the font.

### 7.2.16.5.1.48 LISTBOX\_SetItemDisabled()

#### Description

Modifies the disable state of the given list item of the LISTBOX widget.

#### Prototype

```
void LISTBOX_SetItemDisabled(LISTBOX_Handle hObj,  
                             unsigned      Index,  
                             int           OnOff);
```

#### Parameters

Parameter	Description
<a href="#">hObj</a>	Handle of LISTBOX widget.
<a href="#">Index</a>	Zero based index of the LISTBOX item.
<a href="#">OnOff</a>	1 for disabled, 0 for not disabled.

#### Additional information

When scrolling through a LISTBOX widget disabled items will be skipped. You can not scroll to a disabled item of a LISTBOX widget.

### 7.2.16.5.1.49 LISTBOX\_SetItemSel()

#### Description

Modifies the selection state of the given item of the LISTBOX widget.

#### Prototype

```
void LISTBOX_SetItemSel(LISTBOX_Handle hObj,  
                        unsigned Index,  
                        int OnOff);
```



#### Parameters

Parameter	Description
<a href="#">hObj</a>	Handle of LISTBOX widget.
<a href="#">Index</a>	Zero based index of the LISTBOX item.
<a href="#">OnOff</a>	1 for selected, 0 for not selected.

#### Additional information

Setting the selection state of a LISTBOX item makes only sense when using the multi selection mode. See also `LISTBOX_SetMulti()`.

### 7.2.16.5.1.50 LISTBOX\_SetItemSpacing()

Before	After
	

#### Description

Sets an additional spacing below the items of a LISTBOX widget.

#### Prototype

```
void LISTBOX_SetItemSpacing(LISTBOX_Handle hObj,
                           unsigned      Value);
```

#### Parameters

Parameter	Description
<code>hObj</code>	Handle of LISTBOX widget.
<code>Value</code>	Number of pixels used as additional spacing between the items.



### 7.2.16.5.1.51 LISTBOX\_SetMulti()

#### Description

Switches the multi selection mode of a LISTBOX on or off.

#### Prototype

```
void LISTBOX_SetMulti(LISTBOX_Handle hObj,  
                     int Mode);
```

#### Parameters

Parameter	Description
<code>hObj</code>	Handle of LISTBOX widget.
<code>Mode</code>	0 for off, 1 for on.

#### Additional information

The multi selection mode enables the LISTBOX widget to have more than one selected element. Using the space key would toggle the selection state of a LISTBOX item.

### 7.2.16.5.1.52 LISTBOX\_SetOwnerDraw()

#### Description

Sets the LISTBOX widget to be owner drawn.

#### Prototype

```
void LISTBOX_SetOwnerDraw(LISTBOX_Handle      hObj,
                          WIDGET_DRAW_ITEM_FUNC * pfDrawItem);
```

#### Parameters

Parameter	Description
<code>hObj</code>	Handle of LISTBOX widget.
<code>pfDrawItem</code>	Pointer to owner draw function.

#### Supported commands

- WIDGET\_ITEM\_GET\_XSIZE
- WIDGET\_ITEM\_GET\_YSIZE
- WIDGET\_ITEM\_DRAW (draws item background and item text, only sent for compatibility reasons).
- WIDGET\_ITEM\_DRAW\_BACKGROUND
- WIDGET\_ITEM\_DRAW\_TEXT
- WIDGET\_ITEM\_DRAW\_FOCUS (draws the focus rectangle in multi selection mode).

#### Additional information

This function sets a function pointer to a function which will be called by the widget if a LISTBOX item has to be drawn and when the x or y size of a item is needed. It gives you the possibility to draw anything as LISTBOX item, not just plain text. `pfDrawItem` is a pointer to a application-defined function of type `WIDGET_DRAW_ITEM_FUNC` which is explained at the beginning of the chapter.

#### Note

If `ItemIndex < 0`, the command refers to the empty area where no items of the LISTBOX are drawn.

#### Structure of the user defined owner draw function

The following shows the structure of a typical owner draw function. It assumes that your LISTBOX entries are 30 pixels wider than and have the same height as the item drawn by the default function:

```
static int _OwnerDraw(const WIDGET_DRAW_ITEM_FUNC * pDrawItemInfo) {
    switch (pDrawItemInfo->Cmd) {
        case WIDGET_ITEM_GET_XSIZE:
            return LISTBOX_OwnerDraw(pDrawItemInfo) + 30; /* Returns the default xSize+10
            */
        case WIDGET_ITEM_DRAW:

            /* Your code to be added to draw the LISTBOX item */

            return 0;
    }
    return LISTBOX_OwnerDraw(pDrawItemInfo); /* Def. function for unhandled cmds
    */
}
```

## Example



The source code of this example is available in the examples as `WIDGET_ListBoxOwner-Draw.c`.

### 7.2.16.5.1.53 LISTBOX\_SetScrollbarColor()

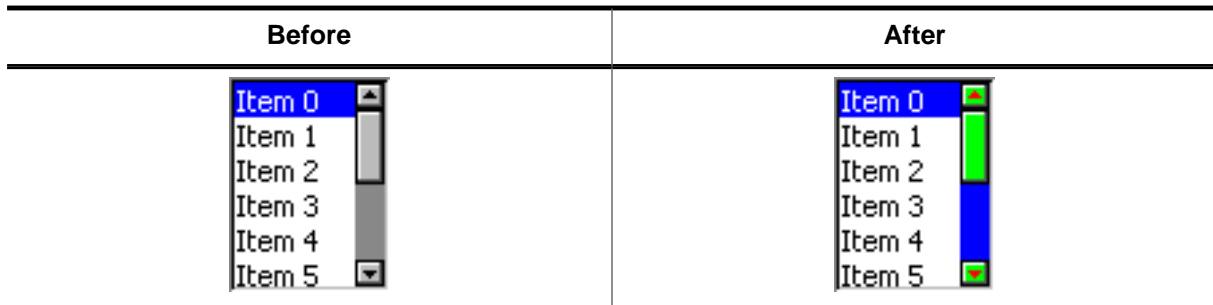

#### Description

Sets the colors of the optional scroll bar.

#### Prototype

```
void LISTBOX_SetScrollbarColor(LISTBOX_Handle hObj,
                               unsigned      Index,
                               GUI_COLOR     Color);
```

#### Parameters

Parameter	Description
<code>hObj</code>	Handle of LISTBOX widget.
<code>Index</code>	<code>Index</code> of desired item. See <i>SCROLLBAR color indexes</i> on page 2212 for a full list of permitted values.
<code>Color</code>	<code>Color</code> to be used.

### 7.2.16.5.1.54 LISTBOX\_SetScrollbarWidth()

#### Description

Sets the width of the scroll bars used by the given LISTBOX widget.

#### Prototype

```
void LISTBOX_SetScrollbarWidth(LISTBOX_Handle hObj,  
                               unsigned      Width);
```

#### Parameters

Parameter	Description
<code>hObj</code>	Handle of LISTBOX widget.
<code>Width</code>	<code>Width</code> of the scroll bar(s) used by the given LISTBOX widget.

### 7.2.16.5.1.55 LISTBOX\_SetScrollStepH()

#### Description

Sets the horizontal scroll step of the given LISTBOX widget. The horizontal scroll step defines the number of pixels to be scrolled if needed.

#### Prototype

```
void LISTBOX_SetScrollStepH(LISTBOX_Handle hObj,  
                           int Value);
```

#### Parameters

Parameter	Description
<a href="#">hObj</a>	Handle of LISTBOX widget.
<a href="#">Value</a>	Number of pixels to be scrolled.

### 7.2.16.5.1.56 LISTBOX\_SetSel()

#### Description

Sets the selected item of a specified LISTBOX widget.

#### Prototype

```
void LISTBOX_SetSel(LISTBOX_Handle hObj,  
                   int NewSel);
```

#### Parameters

Parameter	Description
<code>hObj</code>	Handle of LISTBOX widget.
<code>Sel</code>	Element to be selected.

### 7.2.16.5.1.57 LISTBOX\_SetString()

#### Description

Sets the content of the given item.

#### Prototype

```
void LISTBOX_SetString(    LISTBOX_Handle  hObj,  
                          const char      * s,  
                          unsigned        Index);
```

#### Parameters

Parameter	Description
<a href="#">hObj</a>	Handle of LISTBOX widget.
<a href="#">s</a>	Pointer to string containing the new content.
<a href="#">Index</a>	Zero-based index of element to be changed.

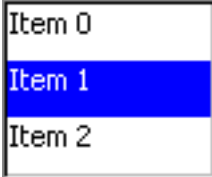
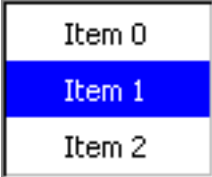

### 7.2.16.5.1.58 LISTBOX\_SetTextAlign()

Before	After
	

#### Description

The function sets the text alignment used to display each item of the LISTBOX widget.

#### Prototype

```
void LISTBOX_SetTextAlign(LISTBOX_Handle hObj,
                          int           Align);
```

#### Parameters

Parameter	Description
<code>hObj</code>	Handle of LISTBOX widget.
<code>Align</code>	Text alignment to be used. List of flags can be found under <i>Text alignment flags</i> on page 286.

#### Additional information

The default alignment of list boxes is `GUI_TA_LEFT`. Per default the height of each item depends on the height of the font used to render the LISTBOX items. So vertical text alignment makes only sense if the function `LISTBOX_SetItemSpacing()` is used to set an additional spacing below the items.

### 7.2.16.5.1.59 LISTBOX\_SetTextColor()

#### Description

Sets the text color of the LISTBOX widget.

#### Prototype

```
GUI_COLOR LISTBOX_SetTextColor(LISTBOX_Handle hObj,  
                               unsigned       Index,  
                               GUI_COLOR     Color);
```

#### Parameters

Parameter	Description
<a href="#">hObj</a>	Handle of LISTBOX widget.
<a href="#">Index</a>	<a href="#">Index</a> for text color (see <a href="#">LISTBOX_SetBackColor</a> on page ).
<a href="#">Color</a>	<a href="#">Color</a> to be set.

### 7.2.16.5.1.60 LISTBOX\_SetUserData()

#### Description

Prototype explained at the beginning of the chapter as `<WIDGET>_SetUserData()` on page 1166.

## 7.2.16.5.2 Defines

### 7.2.16.5.2.1 LISTBOX color indexes

#### Description

Color indexes used by the LISTBOX widget.

#### Definition

```
#define LISTBOX_CI_UNSEL      0
#define LISTBOX_CI_SEL       1
#define LISTBOX_CI_SELFOCUS  2
#define LISTBOX_CI_DISABLED  3
```

#### Symbols

Definition	Description
<a href="#">LISTBOX_CI_UNSEL</a>	Color of unselected element.
<a href="#">LISTBOX_CI_SEL</a>	Color of selected element.
<a href="#">LISTBOX_CI_SELFOCUS</a>	Color of selected element with focus.
<a href="#">LISTBOX_CI_DISABLED</a>	Color of disabled element.

### 7.2.16.5.2 LISTBOX fixed scroll mode flags

#### Description

Defines used for the fixed scroll mode of the widget. Refer to `LISTBOX_SetFixedScrollPos()` for more information.

#### Definition

```
#define LISTBOX_FM_OFF      0
#define LISTBOX_FM_ON      1
#define LISTBOX_FM_CENTER  2
```

#### Symbols

Definition	Description
<a href="#">LISTBOX_FM_OFF</a>	Disables the fixed scroll mode.
<a href="#">LISTBOX_FM_ON</a>	Enables the fixed scroll mode.
<a href="#">LISTBOX_FM_CENTER</a>	Tries to keep the selected item in the center.

## 7.2.16.6 Examples

The `Sample` folder contains the following examples which show how the widget can be used:

- `WIDGET_SimpleListBox.c`
- `WIDGET_ListBox.c`

Note that several other examples also make use of this widget and may also be helpful to get familiar with the widget.

### Screenshot of `WIDGET_SimpleListBox.c`



### Screenshot(s) of `WIDGET_ListBox.c`



## 7.2.17 LISTVIEW: Listview widget

LISTVIEW widgets are used to select one element of a list with several columns. To manage the columns a LISTVIEW widget contains a HEADER widget. A LISTVIEW can be created without a surrounding frame window or as a child window of a FRAMEWIN widget. As items in a listview are selected, they appear highlighted. Note that the background color of a selected item depends on whether the LISTVIEW window has input focus. The table below shows the appearance of the LISTVIEW widget:

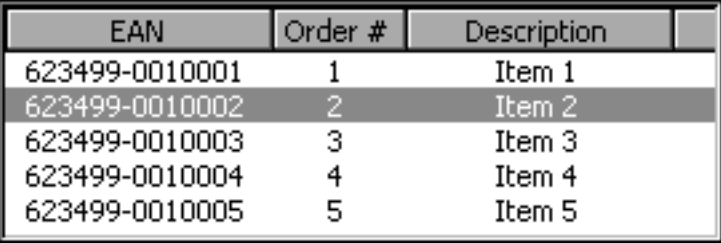
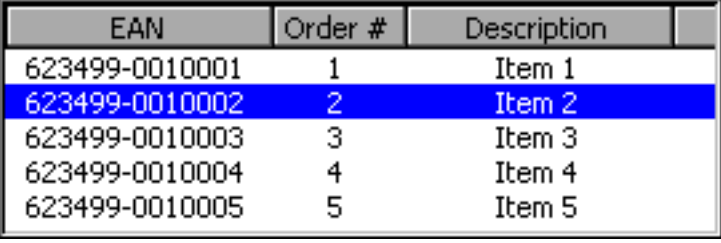
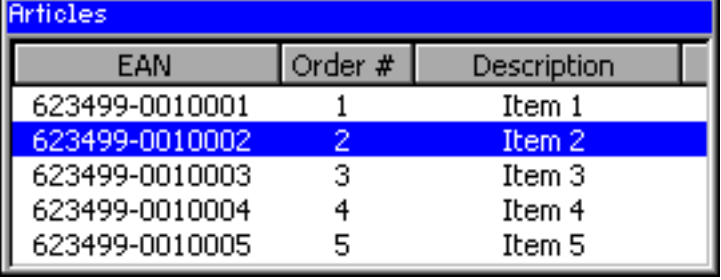
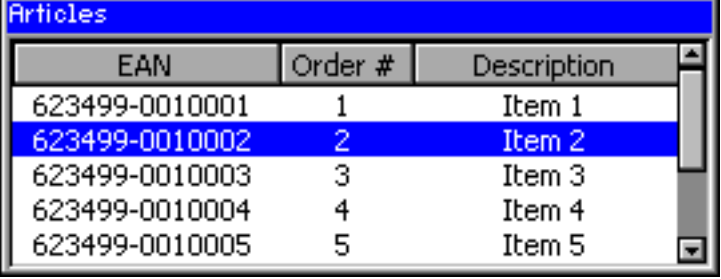
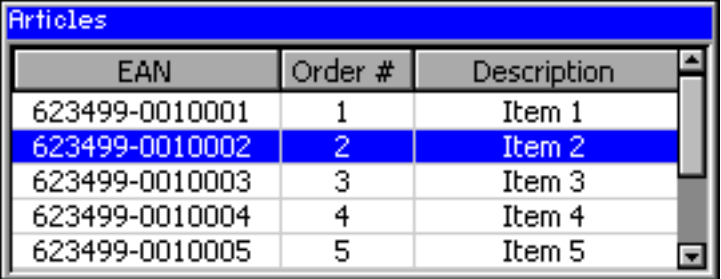
Description	LISTVIEW widget																					
No focus No surrounding FRAMEWIN No SCROLLBAR attached Grid lines not visible	 <table border="1" data-bbox="619 501 1343 743"> <thead> <tr> <th>EAN</th> <th>Order #</th> <th>Description</th> </tr> </thead> <tbody> <tr> <td>623499-0010001</td> <td>1</td> <td>Item 1</td> </tr> <tr> <td>623499-0010002</td> <td>2</td> <td>Item 2</td> </tr> <tr> <td>623499-0010003</td> <td>3</td> <td>Item 3</td> </tr> <tr> <td>623499-0010004</td> <td>4</td> <td>Item 4</td> </tr> <tr> <td>623499-0010005</td> <td>5</td> <td>Item 5</td> </tr> </tbody> </table>	EAN	Order #	Description	623499-0010001	1	Item 1	623499-0010002	2	Item 2	623499-0010003	3	Item 3	623499-0010004	4	Item 4	623499-0010005	5	Item 5			
EAN	Order #	Description																				
623499-0010001	1	Item 1																				
623499-0010002	2	Item 2																				
623499-0010003	3	Item 3																				
623499-0010004	4	Item 4																				
623499-0010005	5	Item 5																				
Has input focus No surrounding FRAMEWIN No SCROLLBAR attached Grid lines not visible	 <table border="1" data-bbox="619 770 1343 1012"> <thead> <tr> <th>EAN</th> <th>Order #</th> <th>Description</th> </tr> </thead> <tbody> <tr> <td>623499-0010001</td> <td>1</td> <td>Item 1</td> </tr> <tr> <td>623499-0010002</td> <td>2</td> <td>Item 2</td> </tr> <tr> <td>623499-0010003</td> <td>3</td> <td>Item 3</td> </tr> <tr> <td>623499-0010004</td> <td>4</td> <td>Item 4</td> </tr> <tr> <td>623499-0010005</td> <td>5</td> <td>Item 5</td> </tr> </tbody> </table>	EAN	Order #	Description	623499-0010001	1	Item 1	623499-0010002	2	Item 2	623499-0010003	3	Item 3	623499-0010004	4	Item 4	623499-0010005	5	Item 5			
EAN	Order #	Description																				
623499-0010001	1	Item 1																				
623499-0010002	2	Item 2																				
623499-0010003	3	Item 3																				
623499-0010004	4	Item 4																				
623499-0010005	5	Item 5																				
Has input focus With surrounding FRAMEWIN No SCROLLBAR attached Grid lines not visible	 <table border="1" data-bbox="619 1039 1343 1317"> <thead> <tr> <th colspan="3">Articles</th> </tr> <tr> <th>EAN</th> <th>Order #</th> <th>Description</th> </tr> </thead> <tbody> <tr> <td>623499-0010001</td> <td>1</td> <td>Item 1</td> </tr> <tr> <td>623499-0010002</td> <td>2</td> <td>Item 2</td> </tr> <tr> <td>623499-0010003</td> <td>3</td> <td>Item 3</td> </tr> <tr> <td>623499-0010004</td> <td>4</td> <td>Item 4</td> </tr> <tr> <td>623499-0010005</td> <td>5</td> <td>Item 5</td> </tr> </tbody> </table>	Articles			EAN	Order #	Description	623499-0010001	1	Item 1	623499-0010002	2	Item 2	623499-0010003	3	Item 3	623499-0010004	4	Item 4	623499-0010005	5	Item 5
Articles																						
EAN	Order #	Description																				
623499-0010001	1	Item 1																				
623499-0010002	2	Item 2																				
623499-0010003	3	Item 3																				
623499-0010004	4	Item 4																				
623499-0010005	5	Item 5																				
Has input focus With surrounding FRAMEWIN SCROLLBAR attached Grid lines not visible	 <table border="1" data-bbox="619 1344 1343 1621"> <thead> <tr> <th colspan="3">Articles</th> </tr> <tr> <th>EAN</th> <th>Order #</th> <th>Description</th> </tr> </thead> <tbody> <tr> <td>623499-0010001</td> <td>1</td> <td>Item 1</td> </tr> <tr> <td>623499-0010002</td> <td>2</td> <td>Item 2</td> </tr> <tr> <td>623499-0010003</td> <td>3</td> <td>Item 3</td> </tr> <tr> <td>623499-0010004</td> <td>4</td> <td>Item 4</td> </tr> <tr> <td>623499-0010005</td> <td>5</td> <td>Item 5</td> </tr> </tbody> </table>	Articles			EAN	Order #	Description	623499-0010001	1	Item 1	623499-0010002	2	Item 2	623499-0010003	3	Item 3	623499-0010004	4	Item 4	623499-0010005	5	Item 5
Articles																						
EAN	Order #	Description																				
623499-0010001	1	Item 1																				
623499-0010002	2	Item 2																				
623499-0010003	3	Item 3																				
623499-0010004	4	Item 4																				
623499-0010005	5	Item 5																				
Has input focus With surrounding FRAMEWIN SCROLLBAR attached Grid lines visible	 <table border="1" data-bbox="619 1644 1343 1921"> <thead> <tr> <th colspan="3">Articles</th> </tr> <tr> <th>EAN</th> <th>Order #</th> <th>Description</th> </tr> </thead> <tbody> <tr> <td>623499-0010001</td> <td>1</td> <td>Item 1</td> </tr> <tr> <td>623499-0010002</td> <td>2</td> <td>Item 2</td> </tr> <tr> <td>623499-0010003</td> <td>3</td> <td>Item 3</td> </tr> <tr> <td>623499-0010004</td> <td>4</td> <td>Item 4</td> </tr> <tr> <td>623499-0010005</td> <td>5</td> <td>Item 5</td> </tr> </tbody> </table>	Articles			EAN	Order #	Description	623499-0010001	1	Item 1	623499-0010002	2	Item 2	623499-0010003	3	Item 3	623499-0010004	4	Item 4	623499-0010005	5	Item 5
Articles																						
EAN	Order #	Description																				
623499-0010001	1	Item 1																				
623499-0010002	2	Item 2																				
623499-0010003	3	Item 3																				
623499-0010004	4	Item 4																				
623499-0010005	5	Item 5																				

**Note**

All LISTVIEW-related routines are located in the file(s) LISTVIEW\*.c, LISTVIEW.h. All identifiers are prefixed LISTVIEW.

**7.2.17.1 Configuration options**

Type	Macro	Default	Description
N	LISTVIEW_ALIGN_DEFAULT	GUI_TA_VCENTER   GUI_TA_HCENTER	Default text alignment.
N	LISTVIEW_BKCOLOR0_DEFAULT	GUI_WHITE	Background color, unselected state.
N	LISTVIEW_BKCOLOR1_DEFAULT	GUI_GRAY	Background color, selected state without focus.
N	LISTVIEW_BKCOLOR2_DEFAULT	GUI_BLUE	Background color, selected state with focus.
N	LISTVIEW_BKCOLOR3_DEFAULT	GUI_LIGHTGRAY	Background color, disabled state.
S	LISTVIEW_FONT_DEFAULT	&GUI_Font13_1	Default font.
N	LISTVIEW_GRIDCOLOR_DEFAULT	GUI_LIGHTGRAY	Color of grid lines (if shown).
N	LISTVIEW_SCROLLSTEP_H_DEFAULT	10	Defines the number of pixels to be scrolled if needed.
N	LISTVIEW_TEXTCOLOR0_DEFAULT	GUI_BLACK	Text color, unselected state.
N	LISTVIEW_TEXTCOLOR1_DEFAULT	GUI_WHITE	Text color, selected state without focus.
N	LISTVIEW_TEXTCOLOR2_DEFAULT	GUI_WHITE	Text color, selected state with focus.
N	LISTVIEW_TEXTCOLOR3_DEFAULT	GUI_GRAY	Text color, disabled state.
N	LISTVIEW_WRAPMODE_DEFAULT	GUI_WRAPMODE_NONE	Wrapping mode.

**7.2.17.2 Predefined IDs**

The following symbols define IDs which may be used to make LISTVIEW widgets distinguishable from creation.

```
#define GUI_ID_LISTVIEW0    0x200
#define GUI_ID_LISTVIEW1    0x201
#define GUI_ID_LISTVIEW2    0x202
#define GUI_ID_LISTVIEW3    0x203
#define GUI_ID_LISTVIEW4    0x204
#define GUI_ID_LISTVIEW5    0x205
#define GUI_ID_LISTVIEW6    0x206
#define GUI_ID_LISTVIEW7    0x207
#define GUI_ID_LISTVIEW8    0x208
#define GUI_ID_LISTVIEW9    0x209
```



### 7.2.17.3 Notification codes

The following events are sent from a LISTVIEW widget to its parent window as part of a WM\_NOTIFY\_PARENT message:

Message	Description
WM_NOTIFICATION_CLICKED	Widget has been clicked.
WM_NOTIFICATION_RELEASED	Widget has been released.
WM_NOTIFICATION_MOVED_OUT	Widget has been clicked and pointer has been moved out of the widget without releasing.
WM_NOTIFICATION_SCROLL_CHANGED	The scroll position has changed either through an attached scrollbar or through motion support (see LISTVIEW_EnableMotion()).
WM_NOTIFICATION_SEL_CHANGED	The selection of the list box has changed.
WM_NOTIFICATION_OVERLAP_TOP_ENTERED	Sent when the overlap area was entered at the top of the LISTVIEW.
WM_NOTIFICATION_OVERLAP_BOTTOM_ENTERED	Sent when the overlap area was entered at the bottom of the LISTVIEW.
WM_NOTIFICATION_OVERLAP_RELEASED	Sent after a dragged overlap area has been released.

### 7.2.17.4 Keyboard reaction

The widget reacts to the following keys if it has the input focus:

Key	Reaction
GUI_KEY_UP	Moves the selection bar up.
GUI_KEY_DOWN	Moves the selection bar down.
GUI_KEY_RIGHT	If the total amount of the column width is > than the inside area of the listview, the content scrolls to the left.
GUI_KEY_LEFT	If the total amount of the column width is > than the inside area of the listview, the content scrolls to the right.
GUI_KEY_PGUP	Moves the selection one page up.
GUI_KEY_PGDOWN	Moves the selection one page down.
GUI_KEY_HOME	Moves the selection to the first element of the list.
GUI_KEY_END	Moves the selection to the last element of the list.

### 7.2.17.5 LISTVIEW API

The table below lists the available emWin LISTVIEW-related routines in alphabetical order. Detailed descriptions of the routines follow.

#### Functions

Routine	Description
<a href="#">LISTVIEW_AddColumn()</a>	Adds a column to a LISTVIEW.
<a href="#">LISTVIEW_AddRow()</a>	Adds a row to a LISTVIEW.
<a href="#">LISTVIEW_Clear()</a>	Removes all items from the LISTVIEW.
<a href="#">LISTVIEW_CompareDec()</a>	Compare function for comparing 2 integer values.
<a href="#">LISTVIEW_CompareText()</a>	Compare function for comparing 2 strings.
<a href="#">LISTVIEW_Create()</a>	Creates a LISTVIEW widget. (Obsolete)

Routine	Description
<code>LISTVIEW_CreateAttached()</code>	Creates a LISTVIEW widget attached to a window.
<code>LISTVIEW_CreateEx()</code>	Creates a LISTVIEW widget.
<code>LISTVIEW_CreateIndirect()</code>	Creates a LISTVIEW widget from a resource table entry.
<code>LISTVIEW_CreateUser()</code>	Creates a LISTVIEW widget using extra bytes as user data.
<code>LISTVIEW_DecSel()</code>	Decrements selection.
<code>LISTVIEW_DeleteAllRows()</code>	Deletes all rows from the given LISTVIEW widget.
<code>LISTVIEW_DeleteColumn()</code>	Deletes the given column.
<code>LISTVIEW_DeleteRow()</code>	Deletes the given row.
<code>LISTVIEW_DisableRow()</code>	Sets the state of the given row to disabled.
<code>LISTVIEW_DisableSort()</code>	Disables sorting of the given LISTVIEW widget.
<code>LISTVIEW_EnableCellSelect()</code>	Enables or disables cell selection mode of the given LISTVIEW widget.
<code>LISTVIEW_EnableMotion()</code>	Enables motion support for the given LISTVIEW widget.
<code>LISTVIEW_EnableRow()</code>	The function sets the state of the given row to enabled.
<code>LISTVIEW_EnableSort()</code>	Enables sorting for the given LISTVIEW widget.
<code>LISTVIEW_GetBkColor()</code>	Returns the background color of the given LISTVIEW widget.
<code>LISTVIEW_GetDefaultBkColor()</code>	Gets the default background color for new LISTVIEW widgets.
<code>LISTVIEW_GetDefaultFont()</code>	Gets the default font for new LISTVIEW widgets.
<code>LISTVIEW_GetDefaultGridColor()</code>	Gets the default color of the grid lines for new LISTVIEW widgets.
<code>LISTVIEW_GetDefaultScrollStepH()</code>	Gets the default scrolling distance for horizontal scrolling.
<code>LISTVIEW_GetDefaultTextColor()</code>	Gets the default text color for new LISTVIEW widgets.
<code>LISTVIEW_GetFont()</code>	Returns a pointer to the font used to display the text of the LISTVIEW widget.
<code>LISTVIEW_GetGridColor()</code>	Returns the grid color of the LISTVIEW.
<code>LISTVIEW_GetHeader()</code>	Returns the handle of the HEADER widget.
<code>LISTVIEW_GetItemRect()</code>	Returns the rectangle of the given LISTVIEW cell by copying the coordinates to the given <code>GUI_RECT</code> structure.
<code>LISTVIEW_GetItemText()</code>	Copies the text of the specified item to the given buffer.
<code>LISTVIEW_GetItemTextLen()</code>	Returns the length in characters of the given text item.
<code>LISTVIEW_GetItemTextSorted()</code>	Copies the text of the specified item to the given buffer.
<code>LISTVIEW_GetLBorder()</code>	Returns the size of the left border within a cell of a LISTVIEW.

Routine	Description
<code>LISTVIEW_GetNumColumns()</code>	Returns the number of columns of the given LISTVIEW widget.
<code>LISTVIEW_GetNumRows()</code>	Returns the number of rows of the given LISTVIEW widget.
<code>LISTVIEW_GetOverlap()</code>	Returns the overlap parameters of the given LISTVIEW widget.
<code>LISTVIEW_GetRBorder()</code>	Returns the size of the right border within a cell of a LISTVIEW.
<code>LISTVIEW_GetScrollStepH()</code>	Returns the currently set horizontal scrolling distance.
<code>LISTVIEW_GetSel()</code>	Returns the index of the currently selected row in a specified LISTVIEW widget.
<code>LISTVIEW_GetSelCol()</code>	Returns the index of the currently selected column.
<code>LISTVIEW_GetSelUnsorted()</code>	Returns the index of the currently selected row in unsorted state.
<code>LISTVIEW_GetTextAlign()</code>	Returns the currently set text alignment for the given column.
<code>LISTVIEW_GetTextColor()</code>	Returns the text color of the given LISTVIEW widget.
<code>LISTVIEW_GetUserData()</code>	Retrieves the data set with <code>LISTVIEW_SetUserData()</code> .
<code>LISTVIEW_GetUserDataRow()</code>	Returns the user data of the given row.
<code>LISTVIEW_GetVisRowIndices()</code>	Retrieves the index of the first and last visible item.
<code>LISTVIEW_GetWrapMode()</code>	Returns the currently used mode for wrapping text.
<code>LISTVIEW_IncSel()</code>	Increments selection.
<code>LISTVIEW_InsertRow()</code>	Inserts a new row into the LISTVIEW at the given position.
<code>LISTVIEW_IsRowPartiallyVisible()</code>	Returns if a row of the LISTVIEW is partially visible, fully visible or not visible at all.
<code>LISTVIEW_OwnerDraw()</code>	Default function for managing drawing operations of one cell.
<code>LISTVIEW_RowIsDisabled()</code>	Returns if a row has been disabled.
<code>LISTVIEW_SetAutoScrollH()</code>	Enables/disables the automatic use of a horizontal scroll bar.
<code>LISTVIEW_SetAutoScrollV()</code>	Enables/disables the automatic use of a vertical scroll bar.
<code>LISTVIEW_SetBkColor()</code>	Sets the background color of the given LISTVIEW widget.
<code>LISTVIEW_SetColumnWidth()</code>	Sets the width of the given column.
<code>LISTVIEW_SetCompareFunc()</code>	Sets the compare function for the given column.
<code>LISTVIEW_SetDefaultBkColor()</code>	Sets the default background color for new LISTVIEW widgets.
<code>LISTVIEW_SetDefaultFont()</code>	Sets the default font for new LISTVIEW widgets.

Routine	Description
<code>LISTVIEW_SetDefaultGridColor()</code>	Sets the default color of the grid lines for new LISTVIEW widgets.
<code>LISTVIEW_SetDefaultScrollStepH()</code>	Sets the default scrolling distance for horizontal scrolling.
<code>LISTVIEW_SetDefaultTextColor()</code>	Sets the default text color for new LISTVIEW widgets.
<code>LISTVIEW_SetFixed()</code>	Fixes the given number of columns at their horizontal positions.
<code>LISTVIEW_SetFont()</code>	Sets the font of the LISTVIEW widget.
<code>LISTVIEW_SetGridColor()</code>	Sets the grid color of the LISTVIEW.
<code>LISTVIEW_SetGridVis()</code>	Sets the visibility flag of the grid lines.
<code>LISTVIEW_SetHeaderHeight()</code>	Sets the height of the attached HEADER widget.
<code>LISTVIEW_SetItemBitmap()</code>	Sets a bitmap as background of the given cell.
<code>LISTVIEW_SetItemBkColor()</code>	Sets the background color of the given cell.
<code>LISTVIEW_SetItemText()</code>	Sets the text of one cell of the LISTVIEW widget specified by row and column.
<code>LISTVIEW_SetItemTextColor()</code>	Sets the text color of the given cell.
<code>LISTVIEW_SetLBorder()</code>	Sets the number of pixels used for the left border within each cell of the LISTVIEW widget.
<code>LISTVIEW_SetOverlap()</code>	Enables motion overlapping for the given LISTVIEW widget.
<code>LISTVIEW_SetOwnerDraw()</code>	Sets an application defined owner draw function for the widget which is responsible for drawing a cell.
<code>LISTVIEW_SetRBorder()</code>	Sets the number of pixels used for the right border within each cell of the LISTVIEW widget.
<code>LISTVIEW_SetRowHeight()</code>	Sets a constant row height.
<code>LISTVIEW_SetScrollPos()</code>	Scrolls the LISTVIEW to a given column and row.
<code>LISTVIEW_SetScrollStepH()</code>	Sets a distance in pixels for horizontal scrolling.
<code>LISTVIEW_SetSel()</code>	Sets the current selected row.
<code>LISTVIEW_SetSelCol()</code>	Sets the current selected column.
<code>LISTVIEW_SetSelUnsorted()</code>	Sets the current selection in unsorted state.
<code>LISTVIEW_SetSort()</code>	Sets the column and sorting order to be sorted by.
<code>LISTVIEW_SetTextAlign()</code>	Sets the alignment for the given column.
<code>LISTVIEW_SetTextColor()</code>	Sets the text color of the given LISTVIEW widget.
<code>LISTVIEW_SetUserData()</code>	Sets the extra data of a LISTVIEW widget.
<code>LISTVIEW_SetUserDataRow()</code>	Sets the user data of the given row.
<code>LISTVIEW_SetWrapMode()</code>	Sets the wrapping mode which should be used for the cells of the given LISTVIEW widget.

## Defines

Group of defines	Description
<code>LISTVIEW_color_indexes</code>	Color indexes used by the LISTVIEW widget.

## 7.2.17.5.1 Functions

### 7.2.17.5.1.1 LISTVIEW\_AddColumn()

#### Description

Adds a new column to a LISTVIEW widget.

#### Prototype

```
int LISTVIEW_AddColumn(    LISTVIEW_Handle  hObj,
                          int                Width,
                          const char        * s,
                          int                Align);
```

#### Parameters

Parameter	Description
<code>hObj</code>	Handle to a LISTVIEW widget
<code>Width</code>	<code>Width</code> of the new column
<code>s</code>	Text to be displayed in the HEADER widget
<code>Align</code>	Text alignment mode to set. In case of -1 the default alignment for LISTVIEW widgets is used. List of flags can be found under <i>Text alignment flags</i> on page 286.

#### Additional information

The `Width`-parameter can be 0. If `Width = 0` the width of the new column will be calculated by the given text and by the default value of the horizontal spacing. You can only add columns to an 'empty' LISTVIEW widget. If it contains 1 or more rows you can not add a new column.

### 7.2.17.5.1.2 LISTVIEW\_AddRow()

#### Description

Adds a new row to a LISTVIEW widget.

#### Prototype

```
int LISTVIEW_AddRow(          LISTVIEW_Handle  hObj,  
                           const GUI_ConstString * ppText);
```

#### Parameters

Parameter	Description
<a href="#">hObj</a>	Handle to a LISTVIEW widget
<a href="#">ppText</a>	Pointer to array containing the text of the LISTVIEW cells

#### Additional information

The [ppText](#)-array should contain one item for each column. If it contains less items the remaining cells left blank.

### 7.2.17.5.1.3 LISTVIEW\_Clear()

#### Description

Removes all items from the LISTVIEW.

#### Prototype

```
void LISTVIEW_Clear(LISTVIEW_Handle hObj);
```

#### Parameters

Parameter	Description
<a href="#">hObj</a>	Handle to a LISTVIEW widget

#### 7.2.17.5.1.4 LISTVIEW\_CompareDec()

##### Description

Compare function for comparing 2 integer values.

##### Prototype

```
int LISTVIEW_CompareDec(const void * p0,  
                       const void * p1);
```

##### Parameters

Parameter	Description
<a href="#">p0</a>	Void pointer to first value.
<a href="#">p1</a>	Void pointer to second value.

##### Return value

< 0     if value of cell 0 greater than value of cell 1.  
= 0     if value of cell 0 identical to value of cell 1.  
> 0     if value of cell 0 less than value of cell 1.

##### Additional information

The purpose of this function is to be used by the listviews sorting algorithm if the cell text represents integer values. For details about how to use this function for sorting, refer also to `LISTVIEW_SetCompareFunc()`. The `Sample` folder contains the example `WIDGET_SortedListView.c` which shows how to use the function.



### 7.2.17.5.1.5 LISTVIEW\_CompareText()

#### Description

Function for comparison of 2 strings.

#### Prototype

```
int LISTVIEW_CompareText(const void * p0,  
                        const void * p1);
```

#### Parameters

Parameter	Description
<code>p0</code>	Void pointer to first text.
<code>p1</code>	Void pointer to second text.

#### Return value

> 0     if text of cell 0 greater than text of cell 1.  
= 0     if text of cell 0 identical to text of cell 1.  
< 0     if text of cell 0 less than text of cell 1.

#### Additional information

The purpose of this function is to be used by the listviews sorting algorithm. For details about how to use this function for sorting, refer also to `LISTVIEW_SetCompareFunc()`. The `Sample` folder contains the example `WIDGET_SortedListview.c` which shows how to use the function.

### 7.2.17.5.1.6 LISTVIEW\_Create()

#### Note

This function is **deprecated**, `LISTVIEW_CreateEx()` should be used instead.

#### Description

Creates a LISTVIEW widget of a specified size at a specified location.

#### Prototype

```
LISTVIEW_Handle LISTVIEW_Create(int    x0,
                                int    y0,
                                int    xSize,
                                int    ySize,
                                WM_HWIN hParent,
                                int    Id,
                                int    Flags,
                                int    ExFlags);
```

#### Parameters

Parameter	Description
<code>x0</code>	Leftmost pixel of the widget (in parent coordinates).
<code>y0</code>	Topmost pixel of the widget (in parent coordinates).
<code>xSize</code>	Horizontal size of the widget (in pixels).
<code>ySize</code>	Vertical size of the widget (in pixels).
<code>hParent</code>	Handle of the parent window
<code>Id</code>	<code>Id</code> of the new widget
<code>Flags</code>	Window create flags. Typically <code>WM_CF_SHOW</code> in order to make the widget visible immediately (refer to <i>Window create flags</i> on page 1146 for a list of available parameter values).
<code>SpecialFlags</code>	(Reserved for later use)

#### Return value

Handle of the created LISTVIEW widget; 0 if the function fails.

### 7.2.17.5.1.7 LISTVIEW\_CreateAttached()

#### Description

Creates a LISTVIEW widget which is attached to an existing window.

#### Prototype

```
LISTVIEW_Handle LISTVIEW_CreateAttached(WM_HWIN hParent,  
                                         int      Id,  
                                         int      SpecialFlags);
```

#### Parameters

Parameter	Description
<a href="#">hObj</a>	Handle to a LISTVIEW widget
<a href="#">Id</a>	<a href="#">Id</a> of the new LISTVIEW widget
<a href="#">SpecialFlags</a>	(Not used, reserved for later use)

#### Return value

Handle of the created LISTVIEW widget; 0 if the function fails.

#### Additional information

An attached LISTVIEW widget is essentially a child window which will position itself on the parent window and operate accordingly.

### 7.2.17.5.1.8 LISTVIEW\_CreateEx()

#### Description

Creates a LISTVIEW widget of a specified size at a specified location.

#### Prototype

```
LISTVIEW_Handle LISTVIEW_CreateEx(int    x0,
                                   int    y0,
                                   int    xSize,
                                   int    ySize,
                                   WM_HWIN hParent,
                                   int    WinFlags,
                                   int    ExFlags,
                                   int    Id);
```

#### Parameters

Parameter	Description
<code>x0</code>	Leftmost pixel of the widget (in parent coordinates).
<code>y0</code>	Topmost pixel of the widget (in parent coordinates).
<code>xSize</code>	Horizontal size of the widget (in pixels).
<code>ySize</code>	Vertical size of the widget (in pixels).
<code>hParent</code>	Handle of parent window. If 0, the new LISTVIEW widget will be a child of the desktop (top-level window).
<code>WinFlags</code>	Window create flags. Typically <code>WM_CF_SHOW</code> in order to make the widget visible immediately (refer to <i>Window create flags</i> on page 1146 for a list of available parameter values).
<code>ExFlags</code>	Not used, reserved for future use.
<code>Id</code>	Window ID of the widget.

#### Return value

Handle of the created LISTVIEW widget; 0 if the function fails.

### 7.2.17.5.1.9 LISTVIEW\_CreateIndirect()

#### Description

The prototype of this function is explained at the beginning of this chapter. Details can be found in the description of the function `<WIDGET>_CreateIndirect()` on page 1161. The element `Para` of the according `GUI_WIDGET_CREATE_INFO` structure is not used. The element `Flags` is used according to the parameter `ExFlags` of the function `LISTVIEW_CreateEx()`.

### 7.2.17.5.1.10 LISTVIEW\_CreateUser()

#### Description

Prototype explained at the beginning of the chapter as `<WIDGET>_CreateUser()` on page 1162. For a detailed description of the parameters the function `LISTVIEW_CreateEx()` can be referred to.

### 7.2.17.5.1.11 LISTVIEW\_DecSel()

#### Description

Decrement the listview selection (moves the selection bar of a specified listview up by one item, if possible).

#### Prototype

```
void LISTVIEW_DecSel(LISTVIEW_Handle hObj);
```

#### Parameters

Parameter	Description
<code>hObj</code>	Handle to a LISTVIEW widget

#### Additional information

Note that the numbering of items always starts from the top with a value of 0; therefore, decrementing the selection will actually move the selection one row up.

### 7.2.17.5.1.12 LISTVIEW\_DeleteAllRows()

#### Description

Deletes all rows from the given LISTVIEW widget.

#### Prototype

```
void LISTVIEW_DeleteAllRows(LISTVIEW_Handle hObj);
```

#### Parameters

Parameter	Description
<a href="#">hObj</a>	Handle to a LISTVIEW widget.



### 7.2.17.5.1.13 LISTVIEW\_DeleteColumn()

#### Description

Deletes the specified column of the LISTVIEW widget.

#### Prototype

```
void LISTVIEW_DeleteColumn(LISTVIEW_Handle hObj,  
                           unsigned Index);
```

#### Parameters

Parameter	Description
<code>hObj</code>	Handle to a LISTVIEW widget
<code>Index</code>	Zero-based index of column to be deleted.

#### Additional information

Note that the numbering of items always starts from the left with a value of 0.

### 7.2.17.5.1.14 LISTVIEW\_DeleteRow()

#### Description

Deletes the specified row of the LISTVIEW widget.

#### Prototype

```
void LISTVIEW_DeleteRow(LISTVIEW_Handle hObj,  
                        unsigned Index);
```

#### Parameters

Parameter	Description
<a href="#">hObj</a>	Handle to a LISTVIEW widget
<a href="#">Index</a>	Zero-based index of row to be deleted.

#### Additional information

Note that the numbering of items always starts from the top with a value of 0.

### 7.2.17.5.1.15 LISTVIEW\_DisableRow()

Before				After			
EAN	Order #	Description		EAN	Order #	Description	
623499-0010001	1	Item 1		623499-0010001	1	Item 1	
623499-0010002	2	Item 2		623499-0010002	2	Item 2	
623499-0010003	3	Item 3		623499-0010003	3	Item 3	
623499-0010004	4	Item 4		623499-0010004	4	Item 4	
623499-0010005	5	Item 5		623499-0010005	5	Item 5	

#### Description

The function sets the state of the given row to disabled.

#### Prototype

```
void LISTVIEW_DisableRow(LISTVIEW_Handle hObj,
                        unsigned Row);
```

#### Parameters

Parameter	Description
<code>hObj</code>	Handle to a LISTVIEW widget.
<code>Row</code>	Zero-based index of the row to be disabled.

#### Additional information

When scrolling through a LISTVIEW widget disabled items will be skipped. You can not scroll to a disabled listview item.

### 7.2.17.5.1.16 LISTVIEW\_DisableSort()

#### Description

Disables sorting of the given LISTVIEW widget. After calling this function the content of the LISTVIEW widget will be shown unsorted.

#### Prototype

```
void LISTVIEW_DisableSort(LISTVIEW_Handle hObj);
```

#### Parameters

Parameter	Description
<code>hObj</code>	Handle to a LISTVIEW widget

#### Additional information

For details about how to use sorting in LISTVIEW widgets, refer to `LISTVIEW_SetCompareFunc()` and `LISTVIEW_SetSort()`. The `Sample` folder contains the example `WIDGET_SortedListView.c` which shows how to use the function.

### 7.2.17.5.1.17 LISTVIEW\_EnableCellSelect()

Before				After			
EAN	Order #	Description		EAN	Order #	Description	
623499-0010001	1	Item 1		623499-0010001	1	Item 1	
623499-0010002	2	Item 2		623499-0010002	2	Item 2	
623499-0010003	3	Item 3		623499-0010003	3	Item 3	
623499-0010004	4	Item 4		623499-0010004	4	Item 4	
623499-0010005	5	Item 5		623499-0010005	5	Item 5	

#### Description

Enables or disables cell selection mode of the given LISTVIEW widget. If cell selection is enabled it is possible to select a cell via the keys up, down, left and right.

#### Prototype

```
void LISTVIEW_EnableCellSelect(LISTVIEW_Handle hObj,
                               unsigned      OnOff);
```

#### Parameters

Parameter	Description
<code>hObj</code>	Handle to a LISTVIEW widget.
<code>OnOff</code>	1 to enable and 0 to disable cell selection mode.

### 7.2.17.5.1.18 LISTVIEW\_EnableMotion()

#### Description

Enables motion support for the given LISTVIEW widget.

#### Prototype

```
void LISTVIEW_EnableMotion(LISTVIEW_Handle hObj,
                           int             Flags);
```

#### Parameters

Parameter	Description
<a href="#">hObj</a>	Handle of LISTVIEW widget.
<a href="#">Flags</a>	See table below.

Permitted values for parameter <a href="#">Flags</a>	
0	Disables motion support.
LISTVIEW_CF_MOTION_H	Enables horizontal motion support.
LISTVIEW_CF_MOTION_V	Enables vertical motion support.

#### Additional information

If motion support isn't enabled for the window manager, it will be activated automatically.

Note that motion support cannot be used in conjunction with SCROLLBAR widgets. This means that enabling motion support on one axis will remove a scrollbar attached to the same axis. This does however **not** apply to SCROLLER widgets.

### 7.2.17.5.1.19 LISTVIEW\_EnableRow()

Before				After			
EAN	Order #	Description		EAN	Order #	Description	
623499-0010001	1	Item 1		623499-0010001	1	Item 1	
623499-0010002	2	Item 2		623499-0010002	2	Item 2	
623499-0010003	3	Item 3		623499-0010003	3	Item 3	
623499-0010004	4	Item 4		623499-0010004	4	Item 4	
623499-0010005	5	Item 5		623499-0010005	5	Item 5	

#### Description

The function sets the state of the given row to enabled.

#### Prototype

```
void LISTVIEW_EnableRow(LISTVIEW_Handle hObj,
                       unsigned Row);
```

#### Parameters

Parameter	Description
<code>hObj</code>	Handle to a LISTVIEW widget.
<code>Row</code>	Zero-based index of the row to be disabled.

#### Additional information

Refer to `LISTVIEW_DisableRow()`.

### 7.2.17.5.1.20 LISTVIEW\_EnableSort()

#### Description

Enables sorting for the given LISTVIEW widget. After calling this function the content of the listview can be rendered sorted after clicking on the header item of the desired column, by which the LISTVIEW widget should sort its data. Note that this works only after a compare function for the desired column has been set.

#### Prototype

```
void LISTVIEW_EnableSort(LISTVIEW_Handle hObj);
```

#### Parameters

Parameter	Description
<a href="#">hObj</a>	Handle to a LISTVIEW widget

#### Additional information

For details about how to set a compare function, refer to `LISTVIEW_SetCompareFunc()`. The `Sample` folder contains the example `WIDGET_SortedListview.c` which shows how to use the function.



### 7.2.17.5.1.21 LISTVIEW\_GetBkColor()

#### Description

Returns the background color of the given LISTVIEW widget.

#### Prototype

```
GUI_COLOR LISTVIEW_GetBkColor(LISTVIEW_Handle hObj,  
                               unsigned Index);
```

#### Parameters

Parameter	Description
<a href="#">hObj</a>	Handle to a LISTVIEW widget
<a href="#">Index</a>	Color index. See <i>LISTVIEW color indexes</i> on page 1870 for a full list of permitted values.

#### Return value

Background color of the given LISTVIEW widget.

### 7.2.17.5.1.22 LISTVIEW\_GetDefaultBkColor()

#### Description

Gets the default background color for new LISTVIEW widgets.

#### Prototype

```
GUI_COLOR LISTVIEW_GetDefaultBkColor(unsigned Index);
```

#### Parameters

Parameter	Description
<a href="#">Index</a>	<a href="#">Index</a> of default background color. See <i>LISTVIEW color indexes</i> on page 1870 for a full list of permitted values.

#### Return value

Default background color.

### 7.2.17.5.1.23 LISTVIEW\_GetDefaultFont()

#### Description

Gets the default font for new LISTVIEW widgets.

#### Prototype

```
GUI_FONT *LISTVIEW_GetDefaultFont(void);
```

#### Return value

Pointer to the default font.

#### 7.2.17.5.1.24 LISTVIEW\_GetDefaultGridColor()

##### Description

Gets the default color of the grid lines for new LISTVIEW widgets.

##### Prototype

```
GUI_COLOR LISTVIEW_GetDefaultGridColor(void);
```

##### Return value

Default grid color.

### 7.2.17.5.1.25 LISTVIEW\_GetDefaultScrollStepH()

#### Description

Gets the default scrolling distance for horizontal scrolling.

#### Prototype

```
int LISTVIEW_GetDefaultScrollStepH(void);
```

#### Return value

Default scrolling distance.

### 7.2.17.5.1.26 LISTVIEW\_GetDefaultTextColor()

#### Description

Gets the default text color for new LISTVIEW widgets.

#### Prototype

```
GUI_COLOR LISTVIEW_GetDefaultTextColor(unsigned Index);
```

#### Parameters

Parameter	Description
<a href="#">Index</a>	<a href="#">Index</a> of default text color. See <i>LISTVIEW color indexes</i> on page 1870 for a full list of permitted values.

#### Return value

Default text color.

### 7.2.17.5.1.27 LISTVIEW\_GetFont()

#### Description

Returns a pointer to the font used to display the text of the LISTVIEW widget.

#### Prototype

```
GUI_FONT *LISTVIEW_GetFont(LISTVIEW_Handle hObj);
```

#### Parameters

Parameter	Description
<a href="#">hObj</a>	Handle to a LISTVIEW widget

#### Return value

Pointer to the font used to display the text of the LISTVIEW widget.

### 7.2.17.5.1.28 LISTVIEW\_GetGridColor()

#### Description

Returns the grid color of the LISTVIEW.

#### Prototype

```
GUI_COLOR LISTVIEW_GetGridColor(LISTVIEW_Handle hObj);
```

#### Parameters

Parameter	Description
<a href="#">hObj</a>	Handle to a LISTVIEW widget

#### Return value

Grid color of the LISTVIEW.



### 7.2.17.5.1.29 LISTVIEW\_GetHeader()

#### Description

Returns the handle of the HEADER widget.

#### Prototype

```
HEADER_Handle LISTVIEW_GetHeader(LISTVIEW_Handle hObj);
```

#### Parameters

Parameter	Description
<a href="#">hObj</a>	Handle to a LISTVIEW widget

#### Return value

Handle of the HEADER widget.

#### Additional information

Each LISTVIEW widget contains a HEADER widget to manage the columns. You can use this handle to change the properties of the LISTVIEW-HEADER, for example to change the text color of the HEADER widget.

#### Example

```
LISTVIEW_Handle hListView = LISTVIEW_Create(10, 80, 270, 89, 0, 1234, WM_CF_SHOW, 0);  
HEADER_Handle  hHeader   = LISTVIEW_GetHeader(hListView);  
HEADER_SetTextColor(hHeader, GUI_GREEN);
```

### 7.2.17.5.1.30 LISTVIEW\_GetItemRect()

#### Description

Returns the rectangle of the given LISTVIEW cell by copying the coordinates to the given GUI\_RECT structure.

#### Prototype

```
void LISTVIEW_GetItemRect(LISTVIEW_Handle  hObj,  
                          U32             Col,  
                          U32             Row,  
                          GUI_RECT        * pRect);
```

#### Parameters

Parameter	Description
<a href="#">hObj</a>	Handle to a LISTVIEW widget
<a href="#">Col</a>	Zero-based index of the cell's column.
<a href="#">Row</a>	Zero-based index of the cell's row
<a href="#">pRect</a>	Pointer to a rectangle to be filled with the item coordinates.

### 7.2.17.5.1.31 LISTVIEW\_GetItemText()

#### Description

Copies the text of the specified item to the given buffer.

#### Prototype

```
void LISTVIEW_GetItemText(LISTVIEW_Handle hObj,
                          unsigned Column,
                          unsigned Row,
                          char * pBuffer,
                          unsigned MaxSize);
```

#### Parameters

Parameter	Description
<code>hObj</code>	Handle to a LISTVIEW widget
<code>Column</code>	Zero-based index of the cell's column.
<code>Row</code>	Zero-based index of the cell's row
<code>pBuffer</code>	Pointer to a buffer to be filled by the routine.
<code>MaxSize</code>	Size in bytes of the buffer.

#### Additional information

If the text of the cell does not fit into the buffer, the number of bytes specified by the parameter `MaxSize` will be copied to the buffer.

### 7.2.17.5.1.32 LISTVIEW\_GetItemTextLen()

#### Description

Returns the length in characters of the given text item.

#### Prototype

```
unsigned LISTVIEW_GetItemTextLen(LISTVIEW_Handle hObj,  
                                unsigned         Column,  
                                unsigned         Row);
```

#### Parameters

Parameter	Description
<a href="#">hObj</a>	Handle to a LISTVIEW widget
<a href="#">Column</a>	Zero-based index of the cell's column.
<a href="#">Row</a>	Zero-based index of the cell's row

#### Return value

Length in characters of the given text item.

### 7.2.17.5.1.33 LISTVIEW\_GetItemTextSorted()

#### Description

Copies the text of the specified item to the given buffer. Parameter [Row](#) specifies the index of the sorted LISTVIEW widget.

#### Prototype

```
void LISTVIEW_GetItemTextSorted(LISTVIEW_Handle hObj,
                                unsigned Column,
                                unsigned Row,
                                char * pBuffer,
                                unsigned MaxSize);
```

#### Parameters

Parameter	Description
<a href="#">hObj</a>	Handle to a LISTVIEW widget
<a href="#">Column</a>	Zero-based index of the cell's column.
<a href="#">Row</a>	Zero-based sorted index of the cell's row.
<a href="#">pBuffer</a>	Pointer to a buffer to be filled by the routine.
<a href="#">MaxSize</a>	Size in bytes of the buffer.

#### Additional information

If the text of the cell does not fit into the buffer, the number of bytes specified by the parameter [MaxSize](#) will be copied to the buffer.

### 7.2.17.5.1.34 LISTVIEW\_GetLBorder()

#### Description

Returns the size of the left border within a cell of a LISTVIEW. This value can be set with `LISTVIEW_SetLBorder()`.

#### Prototype

```
unsigned LISTVIEW_GetLBorder(LISTVIEW_Handle hObj);
```

#### Parameters

Parameter	Description
<code>hObj</code>	Handle to a LISTVIEW widget.

#### Return value

Size of left border.

### 7.2.17.5.1.35 LISTVIEW\_GetNumColumns()

#### Description

Returns the number of columns of the given LISTVIEW widget.

#### Prototype

```
unsigned LISTVIEW_GetNumColumns(LISTVIEW_Handle hObj);
```

#### Parameters

Parameter	Description
<a href="#">hObj</a>	Handle to a LISTVIEW widget

#### Return value

Number of columns of the given LISTVIEW widget.

### 7.2.17.5.1.36 LISTVIEW\_GetNumRows()

#### Description

Returns the number of rows of the given LISTVIEW widget.

#### Prototype

```
unsigned LISTVIEW_GetNumRows(LISTVIEW_Handle hObj);
```

#### Parameters

Parameter	Description
<a href="#">hObj</a>	Handle to a LISTVIEW widget

#### Return value

Number of rows of the given LISTVIEW widget.



### 7.2.17.5.1.37 LISTVIEW\_GetOverlap()

#### Description

Returns the overlap parameters of the given LISTVIEW widget.

#### Prototype

```
unsigned LISTVIEW_GetOverlap(LISTVIEW_Handle  hObj,
                             int             * pPeriod,
                             U8              * pFlags);
```

#### Parameters

Parameter	Description
<code>hObj</code>	Handle of LISTVIEW widget.
<code>pPeriod</code>	<b>out</b> Pointer to store the currently set moving back period.
<code>pFlags</code>	<b>out</b> Pointer to store the currently set overlap flags.

#### Return value

Overlapping value in pixels.

#### Additional information

See `LISTVIEW_SetOverlap()` for additional information on overlapping distance.

### 7.2.17.5.1.38 LISTVIEW\_GetRBorder()

#### Description

Returns the size of the right border within a cell of a LISTVIEW. This value can be set with `LISTVIEW_SetRBorder()`.

#### Prototype

```
unsigned LISTVIEW_GetRBorder(LISTVIEW_Handle hObj);
```

#### Parameters

Parameter	Description
<code>hObj</code>	Handle to a LISTVIEW widget.

#### Return value

Size of right border.

### 7.2.17.5.1.39 LISTVIEW\_GetScrollStepH()

#### Description

Returns the currently set horizontal scrolling distance.

#### Prototype

```
int LISTVIEW_GetScrollStepH(LISTVIEW_Handle hObj);
```

#### Parameters

Parameter	Description
<a href="#">hObj</a>	Handle to a LISTVIEW widget

#### Return value

- > 0 Distance in px for horizontal scrolling.
- = 0 Column-wise scrolling is active.
- = -1 Invalid handle.

#### 7.2.17.5.1.40 LISTVIEW\_GetSel()

##### Description

Returns the index of the currently selected row in a specified LISTVIEW widget.

##### Prototype

```
int LISTVIEW_GetSel(LISTVIEW_Handle hObj);
```

##### Parameters

Parameter	Description
<a href="#">hObj</a>	Handle to a LISTVIEW widget

##### Return value

Index of the currently selected row.

#### 7.2.17.5.1.41 LISTVIEW\_GetSelCol()

##### Description

Returns the index of the currently selected column.

##### Prototype

```
int LISTVIEW_GetSelCol(LISTVIEW_Handle hObj);
```

##### Parameters

Parameter	Description
<a href="#">hObj</a>	Handle to a LISTVIEW widget

##### Return value

Index of the currently selected column.

### 7.2.17.5.1.42 LISTVIEW\_GetSelUnsorted()

#### Description

Returns the index of the currently selected row in unsorted state.

#### Prototype

```
int LISTVIEW_GetSelUnsorted(LISTVIEW_Handle hObj);
```

#### Parameters

Parameter	Description
<a href="#">hObj</a>	Handle to a LISTVIEW widget

#### Return value

Index of the currently selected row in unsorted state.

#### Additional information

This function returns the actual index of the selected row, whereas the function `LISTVIEW_GetSel()` only returns the index of the sorted row. The actual (unsorted) row index should be used in function calls as row index. The `Sample` folder contains the example `WIDGET_SortedListview.c` which shows how to use the function.

### 7.2.17.5.1.43 LISTVIEW\_GetTextAlign()

#### Description

Returns the currently set text alignment for the given column.

#### Prototype

```
int LISTVIEW_GetTextAlign(LISTVIEW_Handle hObj,  
                          unsigned ColIndex);
```

#### Parameters

Parameter	Description
<code>hObj</code>	Handle to a LISTVIEW widget.
<code>ColIndex</code>	Zero-based index of column.

#### Return value

- = -1 On error.
- ≠ -1 Text alignment of given column. Refer to *Text alignment flags* on page 286.

#### 7.2.17.5.1.44 LISTVIEW\_GetTextColor()

##### Description

Returns the text color of the given LISTVIEW widget.

##### Prototype

```
GUI_COLOR LISTVIEW_GetTextColor(LISTVIEW_Handle hObj,  
                                unsigned Index);
```

##### Parameters

Parameter	Description
<a href="#">hObj</a>	Handle to a LISTVIEW widget.
<a href="#">Index</a>	<a href="#">Index</a> of color. See <i>LISTVIEW color indexes</i> on page 1870 for a full list of permitted values.

##### Return value

Text color of the given LISTVIEW widget.



#### 7.2.17.5.1.45 LISTVIEW\_GetUserData()

##### Description

Prototype explained at the beginning of the chapter as `<WIDGET>_GetUserData()` on page 1165.

### 7.2.17.5.1.46 LISTVIEW\_GetUserDataRow()

#### Description

Returns the user data of the given row.

#### Prototype

```
U32 LISTVIEW_GetUserDataRow(LISTVIEW_Handle hObj,  
                           unsigned Row);
```

#### Parameters

Parameter	Description
<a href="#">hObj</a>	Handle to a LISTVIEW widget.
<a href="#">Row</a>	Zero-based index of row.

#### Return value

User data of the given row.

#### Additional information

Details on how to set user data for a row can be found in the description of the function `LISTVIEW_SetUserDataRow()`.

### 7.2.17.5.1.47 LISTVIEW\_GetVisRowIndices()

#### Description

Retrieves the index of the first and last visible item. The function also returns the total number of visible items.

#### Prototype

```
int LISTVIEW_GetVisRowIndices(LISTVIEW_Handle hObj,
                             int * pFirst,
                             int * pLast);
```

#### Parameters

Parameter	Description
<code>hObj</code>	Handle to a LISTVIEW widget
<code>pFirst</code>	Pointer to an integer that stores the zero-based index of the first visible row of the LISTVIEW.
<code>pLast</code>	Pointer to an integer that stores the zero-based index of the last visible row of the LISTVIEW.

#### Return value

= -1 Error.  
 ≠ -1 Number of visible items.

#### Additional information

This function also takes partially visible rows into account. By using the function `LISTVIEW_IsRowPartiallyVisible()`, it can be checked if a row is only partially visible, fully visible or not visible at all.

### 7.2.17.5.1.48 LISTVIEW\_GetWrapMode()

#### Description

Returns the currently used mode for wrapping text.

#### Prototype

```
GUI_WRAPMODE LISTVIEW_GetWrapMode(LISTVIEW_Handle hObj);
```

#### Parameters

Parameter	Description
<a href="#">hObj</a>	Handle to a LISTVIEW widget.

#### Return value

Currently used wrap mode.

#### Additional information

Details on how to use text wrapping can be found in the description of the function `LISTVIEW_SetWrapMode()`.

### 7.2.17.5.1.49 LISTVIEW\_IncSel()

#### Description

Increment the selection of the LISTVIEW widget (moves the selection bar of a specified LISTVIEW down by one item).

#### Prototype

```
void LISTVIEW_IncSel(LISTVIEW_Handle hObj);
```

#### Parameters

Parameter	Description
<code>hObj</code>	Handle to a LISTVIEW widget.

### 7.2.17.5.1.50 LISTVIEW\_InsertRow()

#### Description

Inserts a new row into the LISTVIEW at the given position.

#### Prototype

```
int LISTVIEW_InsertRow(    LISTVIEW_Handle  hObj,
                          unsigned         Index,
                          const GUI_ConstString * ppText);
```

#### Parameters

Parameter	Description
<code>hObj</code>	Handle to a LISTVIEW widget.
<code>Index</code>	<code>Index</code> of the new row.
<code>ppText</code>	Pointer to a string array containing the cell data of the new row.

#### Return value

0        if function succeed  
1        if an error occurs.

#### Additional information

The `ppText`-array should contain one item for each column. If it contains less items the remaining cells left blank.

If the given index is  $\geq$  the current number of rows, the function `LISTVIEW_AddRow()` will be used to add the new row.

The `Sample` folder contains the example `WIDGET_SortedListview.c` which shows how to use the function.

### 7.2.17.5.1.51 LISTVIEW\_IsRowPartiallyVisible()

#### Description

Returns if a row of the LISTVIEW is partially visible, fully visible or not visible at all.

#### Prototype

```
int LISTVIEW_IsRowPartiallyVisible(LISTVIEW_Handle hObj,  
                                   unsigned Index);
```

#### Parameters

Parameter	Description
<code>hObj</code>	Handle to a LISTVIEW widget
<code>Index</code>	Zero-based index of the row to be checked.

#### Return value

- 1 Error.
- 0 Row is not visible at all.
- 1 Row is partially visible.
- 2 Row is fully visible.

### 7.2.17.5.1.52 LISTVIEW\_OwnerDraw()

#### Description

Default function for managing drawing operations of one cell.

#### Prototype

```
int LISTVIEW_OwnerDraw(const WIDGET_ITEM_DRAW_INFO * pDrawItemInfo);
```

#### Parameters

Parameter	Description
<code>pDrawItemInfo</code>	Pointer to a <code>WIDGET_ITEM_DRAW_INFO</code> structure.

#### Return value

Depends on the command in the `Cmd` element of the `WIDGET_ITEM_DRAW_INFO` structure pointed by `pDrawItemInfo`.

#### Additional information

This function is useful if `LISTVIEW_SetOwnerDraw()` is used. It can be used to retrieve the original size of a data item and/or to draw the text of a data item and should be called for all commands which are not managed by the application defined owner draw function.

The following commands are managed by the default function:

- `WIDGET_ITEM_GET_XSIZE`
- `WIDGET_ITEM_GET_YSIZE`
- `WIDGET_ITEM_DRAW`
- `WIDGET_DRAW_BACKGROUND`



### 7.2.17.5.1.53 LISTVIEW\_RowsDisabled()

#### Description

Returns if a row has been disabled.

#### Prototype

```
unsigned LISTVIEW_RowsDisabled(LISTVIEW_Handle hObj,  
                               unsigned Row);
```

#### Parameters

Parameter	Description
<code>hObj</code>	Handle to a LISTVIEW widget.
<code>Row</code>	Zero-based index of the row to be checked.

#### Return value

- 0 `Row` is not disabled.
- 1 `Row` is disabled.

#### Additional information

Rows of a LISTVIEW widget can be disabled using `LISTVIEW_DisableRow()` and enabled with `LISTVIEW_EnableRow()`.

### 7.2.17.5.1.54 LISTVIEW\_SetAutoScrollH()

#### Description

Enables/disables the automatic use of a horizontal scroll bar.

#### Prototype

```
void LISTVIEW_SetAutoScrollH(LISTVIEW_Handle hObj,
                             int State);
```

#### Parameters

Parameter	Description
<a href="#">hObj</a>	Handle to a LISTVIEW widget.
<a href="#">State</a>	See table below.

Permitted values for parameter <a href="#">OnOff</a>	
0	Disable automatic use of a horizontal scroll bar.
1	Enable automatic use of a horizontal scroll bar.

#### Additional information

If enabled the LISTVIEW checks if all columns fit into the widgets area. If not a horizontal scroll bar will be added.

### 7.2.17.5.1.55 LISTVIEW\_SetAutoScrollV()

#### Description

Enables/disables the automatic use of a vertical scroll bar.

#### Prototype

```
void LISTVIEW_SetAutoScrollV(LISTVIEW_Handle hObj,  
                             int State);
```

#### Parameters

Parameter	Description
<a href="#">hObj</a>	Handle to a LISTVIEW widget.
<a href="#">State</a>	See table below.

Permitted values for parameter <a href="#">OnOff</a>	
0	Disable automatic use of a vertical scroll bar.
1	Enable automatic use of a vertical scroll bar.

#### Additional information

If enabled the LISTVIEW checks if all rows fit into the widgets area. If not a vertical scroll bar will be added.

### 7.2.17.5.1.56 LISTVIEW\_SetBkColor()

#### Description

Sets the background color of the given LISTVIEW widget.

#### Prototype

```
void LISTVIEW_SetBkColor(LISTVIEW_Handle hObj,  
                        unsigned int   Index,  
                        GUI_COLOR     Color);
```

#### Parameters

Parameter	Description
<a href="#">hObj</a>	Handle to a LISTVIEW widget.
<a href="#">Index</a>	<a href="#">Index</a> for background color. See <i>LISTVIEW color indexes</i> on page 1870 for a full list of permitted values.
<a href="#">Color</a>	<a href="#">Color</a> to be set.

#### Additional information

To set the background color for a single cell the function `LISTVIEW_SetItemBkColor()` should be used. The `Sample` folder contains the example `WIDGET_SortedListview.c` which shows how to use the function.

### 7.2.17.5.1.57 LISTVIEW\_SetColumnWidth()

#### Description

Sets the width of the given column.

#### Prototype

```
void LISTVIEW_SetColumnWidth(LISTVIEW_Handle hObj,  
                             unsigned int   Index,  
                             int           Width);
```

#### Parameters

Parameter	Description
<a href="#">hObj</a>	Handle to a LISTVIEW widget.
<a href="#">Index</a>	Number of column
<a href="#">Width</a>	New width

### 7.2.17.5.1.58 LISTVIEW\_SetCompareFunc()

#### Description

Sets the compare function for the given column. A compare function needs to be set if the LISTVIEW widget should be sorted by the given column.

#### Prototype

```
void LISTVIEW_SetCompareFunc
    (LISTVIEW_Handle hObj,
     unsigned        Column,
     int             (*fpCompare)(const void * p0 , const void * p1 ));
```

#### Parameters

Parameter	Description
hObj	Handle to a LISTVIEW widget.
Column	Index of the desired column for which the compare function should be set.
fpCompare	Function pointer to compare function.

#### Additional information

If the sorting feature of the listview widget is used, the widget uses a compare function to decide if the content of one cell is greater, equal or less than the content of the other cell.

Per default no compare function is set for the LISTVIEW columns. For each column which should be used for sorting, a compare function needs to be set. The cells of the LISTVIEW widget contain text. But sometimes the text represents data of other types like dates, integers or others. So different compare functions are required for sorting. emWin provides 2 compare functions:

- LISTVIEW\_CompareText()      Function can be used for comparing cells containing text.
- LISTVIEW\_CompareDec()      Function can be used for comparing cells which text, where the content represents integer values.

The compare function should return a value >0, if the content of the second cell is greater than the content of the first cell and <0, if the content of the second cell is less than the content of the first cell or 0 if equal.

Also user defined compare functions can be used. The prototype of a application-defined function should be defined as follows:

#### Prototype

```
int APPLICATION_Compare(const void * p0,
                       const void * p1);
```

Parameter	Description
p0	Pointer to NULL terminated string data of the first cell.
p1	Pointer to NULL terminated string data of the second cell.

#### Example

```
int APPLICATION_Compare(const void * p0, const void * p1) {
    return strcmp((const char *)p1, (const char *)p0);
}
void SetAppCompareFunc(WM_HWIN hListView, int Column) {
    LISTVIEW_SetCompareFunc(hListView, Column, APPLICATION_Compare);
}
```

The `Sample` folder contains the example `WIDGET_SortedListview.c` which shows how to use the function.

### 7.2.17.5.1.59 LISTVIEW\_SetDefaultBkColor()

#### Description

Sets the default background color for new LISTVIEW widgets.

#### Prototype

```
GUI_COLOR LISTVIEW_SetDefaultBkColor(unsigned Index,  
                                     GUI_COLOR Color);
```

#### Parameters

Parameter	Description
<a href="#">Index</a>	<a href="#">Index</a> of default background color. See <i>LISTVIEW color indexes</i> on page 1870 for a full list of permitted values.
<a href="#">Color</a>	<a href="#">Color</a> to be set as default

#### Return value

Previous default background color.



### 7.2.17.5.1.60 LISTVIEW\_SetDefaultFont()

#### Description

Sets the default font for new LISTVIEW widgets.

#### Prototype

```
GUI_FONT *LISTVIEW_SetDefaultFont(const GUI_FONT * pFont);
```

#### Parameters

Parameter	Description
<code>pFont</code>	Pointer to font used for new LISTVIEW widgets.

#### Return value

Pointer to the previous default font.

### 7.2.17.5.1.61 LISTVIEW\_SetDefaultGridColor()

#### Description

Sets the default color of the grid lines for new LISTVIEW widgets.

#### Prototype

```
GUI_COLOR LISTVIEW_SetDefaultGridColor(GUI_COLOR Color);
```

#### Parameters

Parameter	Description
Color	New default value.

#### Return value

Previous default grid color.

### 7.2.17.5.1.62 LISTVIEW\_SetDefaultScrollStepH()

#### Description

Sets the default scrolling distance for horizontal scrolling.

#### Prototype

```
int LISTVIEW_SetDefaultScrollStepH(int Dist);
```

#### Parameters

Parameter	Description
<code>Dist</code>	New default value.

#### Return value

Previous default scrolling distance.

### 7.2.17.5.1.63 LISTVIEW\_SetDefaultTextColor()

#### Description

Sets the default text color for new LISTVIEW widgets.

#### Prototype

```
GUI_COLOR LISTVIEW_SetDefaultTextColor(unsigned Index,  
                                       GUI_COLOR Color);
```

#### Parameters

Parameter	Description
<a href="#">Index</a>	<a href="#">Index</a> of default text color. See <i>LISTVIEW color indexes</i> on page 1870 for a full list of permitted values.
<a href="#">Color</a>	<a href="#">Color</a> to be set as default.

#### Return value

Previous default text color.

### 7.2.17.5.1.64 LISTVIEW\_SetFixed()

#### Description

Fixes the given number of columns at their horizontal positions.

#### Prototype

```
unsigned LISTVIEW_SetFixed(LISTVIEW_Handle hObj,  
                           unsigned Fixed);
```

#### Parameters

Parameter	Description
<code>hObj</code>	Handle to a LISTVIEW widget.
<code>Fixed</code>	Number of columns to be fixed at their horizontal positions.

#### Return value

Old number of fixed columns.

#### Additional information

Using this function makes sense if one or more columns should remain at their horizontal positions during scrolling operations.

### 7.2.17.5.1.65 LISTVIEW\_SetFont()

#### Description

Sets the font of the LISTVIEW widget.

#### Prototype

```
void LISTVIEW_SetFont(      LISTVIEW_Handle  hObj,  
                          const GUI_FONT    * pFont);
```

#### Parameters

Parameter	Description
<code>hObj</code>	Handle to a LISTVIEW widget.
<code>pFont</code>	Pointer to the font.

### 7.2.17.5.1.66 LISTVIEW\_SetGridVis()

#### Description

Sets the visibility flag of the grid lines. When creating a LISTVIEW the grid lines are disabled per default.

#### Prototype

```
int LISTVIEW_SetGridVis(LISTVIEW_Handle hObj,  
                        int Show);
```

#### Parameters

Parameter	Description
<a href="#">hObj</a>	Handle to a LISTVIEW widget.
<a href="#">Show</a>	Sets the visibility of the grid lines.

Permitted values for parameter <a href="#">Show</a>	
0	Not visible.
1	Visible

#### Return value

Previous value of the visibility flag.

### 7.2.17.5.1.67 LISTVIEW\_SetHeaderHeight()

#### Description

Sets the height of the attached HEADER widget.

#### Prototype

```
void LISTVIEW_SetHeaderHeight(LISTVIEW_Handle hObj,  
                             unsigned HeaderHeight);
```

#### Parameters

Parameter	Description
<a href="#">hObj</a>	Handle to a LISTVIEW widget.
<a href="#">Show</a>	Height of the attached HEADER widget to be set.

#### Additional information

Setting the height to 0 causes the HEADER widget not to be displayed.



### 7.2.17.5.1.68 LISTVIEW\_SetItemBitmap()

Before			After		
Column 1	Column 2	Column 3	Column 1	Column 2	Column 3
Cell 1	Cell 2	Cell 3	Cell 1	Cell 2	Cell 3
Cell 4	Cell 5	Cell 6	Cell 4	Cell 5	Cell 6
Cell 7	Cell 8	Cell 9	Cell 7	Cell 8	Cell 9

#### Description

Sets a bitmap as background of the given cell.

#### Prototype

```
void LISTVIEW_SetItemBitmap(    LISTVIEW_Handle  hObj,
                               unsigned    Column,
                               unsigned    Row,
                               int         xOff,
                               int         yOff,
                               const GUI_BITMAP * pBitmap);
```

#### Parameters

Parameter	Description
<a href="#">hObj</a>	Handle to a LISTVIEW widget.
<a href="#">Column</a>	Number of column.
<a href="#">Row</a>	Number of row.
<a href="#">xOff</a>	Offset for the leftmost pixel of the bitmap to be drawn.
<a href="#">yOff</a>	Offset for the topmost pixel of the bitmap to be drawn.
<a href="#">pBitmap</a>	Pointer to the bitmap.

### 7.2.17.5.1.69 LISTVIEW\_SetItemBkColor()

Before				After			
Col 0	Col 1	Col 2	Col 3	Col 0	Col 1	Col 2	Col 3
Item 0/0	Item 1/0	Item 2/0	Item 3/0	Item 0/0	Item 1/0	Item 2/0	Item 3/0
Item 0/1	Item 1/1	Item 2/1	Item 3/1	Item 0/1	Item 1/1	Item 2/1	Item 3/1
Item 0/2	Item 1/2	Item 2/2	Item 3/2	Item 0/2	Item 1/2	Item 2/2	Item 3/2
Item 0/3	Item 1/3	Item 2/3	Item 3/3	Item 0/3	Item 1/3	Item 2/3	Item 3/3

#### Description

Sets the background color of the given cell.

#### Prototype

```
void LISTVIEW_SetItemBkColor(LISTVIEW_Handle hObj,
                             unsigned Column,
                             unsigned Row,
                             unsigned Index,
                             GUI_COLOR Color);
```

#### Parameters

Parameter	Description
<code>hObj</code>	Handle to a LISTVIEW widget
<code>Column</code>	Number of columns.
<code>Row</code>	Number of rows.
<code>Index</code>	<code>Index</code> of background color. See <i>LISTVIEW color indexes</i> on page 1870 for a full list of permitted values.
<code>Color</code>	<code>Color</code> to be used.

#### Additional information

This function overwrites the default background color for the given cell set by `LISTVIEW_SetBkColor()`.

### 7.2.17.5.1.70 LISTVIEW\_SetItemText()

#### Description

Sets the text of one cell of the LISTVIEW widget specified by row and column.

#### Prototype

```
void LISTVIEW_SetItemText(    LISTVIEW_Handle  hObj,  
                             unsigned          Column,  
                             unsigned          Row,  
                             const char       * s);
```

#### Parameters

Parameter	Description
<code>hObj</code>	Handle to a LISTVIEW widget
<code>Column</code>	Number of column.
<code>Row</code>	Number of row.
<code>s</code>	Text to be displayed in the table cell.

### 7.2.17.5.1.71 LISTVIEW\_SetItemTextColor()

Before				After			
Col 0	Col 1	Col 2	Col 3	Col 0	Col 1	Col 2	Col 3
Item 0/0	Item 1/0	Item 2/0	Item 3/0	Item 0/0	Item 1/0	Item 2/0	Item 3/0
Item 0/1	Item 1/1	Item 2/1	Item 3/1	Item 0/1	Item 1/1	Item 2/1	Item 3/1
Item 0/2	Item 1/2	Item 2/2	Item 3/2	Item 0/2	Item 1/2	Item 2/2	Item 3/2
Item 0/3	Item 1/3	Item 2/3	Item 3/3	Item 0/3	Item 1/3	Item 2/3	Item 3/3

#### Description

Sets the text color of the given cell.

#### Prototype

```
void LISTVIEW_SetItemTextColor(LISTVIEW_Handle hObj,
                               unsigned Column,
                               unsigned Row,
                               unsigned Index,
                               GUI_COLOR Color);
```

#### Parameters

Parameter	Description
<code>hObj</code>	Handle to a LISTVIEW widget
<code>Column</code>	Number of column.
<code>Row</code>	Number of row.
<code>Index</code>	<code>Index</code> of text color. See <i>LISTVIEW color indexes</i> on page 1870 for a full list of permitted values.
<code>Color</code>	<code>Color</code> to be used.

#### Additional information

This function overwrites the default text color for the given cell set by `LISTVIEW_SetTextColor()`.

### 7.2.17.5.1.72 LISTVIEW\_SetItemTextSorted()

#### Description

Sets the text of the given item in a sorted LISTVIEW widget.

#### Prototype

```
void LISTVIEW_SetItemTextSorted(    LISTVIEW_Handle  hObj,  
                                   unsigned             Column,  
                                   unsigned             Row,  
                                   const char           * pText);
```

#### Parameters

Parameter	Description
<code>hObj</code>	Handle to a LISTVIEW widget
<code>Column</code>	Number of column.
<code>Row</code>	Number of row.
<code>pText</code>	Pointer to the given NULL terminated text.

### 7.2.17.5.1.73 LISTVIEW\_SetLBorder()

Before			After		
Column 0	Column 1	Column 2	Column 0	Column 1	Column 2
Item 0/0	Item 1/0	Item 2/0	Item 0/0	Item 1/0	Item 2/0
Item 0/1	Item 1/1	Item 2/1	Item 0/1	Item 1/1	Item 2/1
Item 0/2	Item 1/2	Item 2/2	Item 0/2	Item 1/2	Item 2/2
Item 0/3	Item 1/3	Item 2/3	Item 0/3	Item 1/3	Item 2/3

#### Description

Sets the number of pixels used for the left border within each cell of the LISTVIEW widget.

#### Prototype

```
void LISTVIEW_SetLBorder(LISTVIEW_Handle hObj,
                        unsigned         BorderSize);
```

#### Parameters

Parameter	Description
<code>hObj</code>	Handle to a LISTVIEW widget
<code>BorderSize</code>	Number of pixels to be used.

#### Additional information

Using this function has no effect to the HEADER widget used by the LISTVIEW widget.

### 7.2.17.5.1.74 LISTVIEW\_SetOverlap()

#### Description

Enables motion overlapping for the given LISTVIEW widget. This requires motion support to be enabled for the widget (see `LISTVIEW_EnableMotion()`).

When active, the widget also sends notifications to its parent window when the overlapping area is entered and left. See *Notification codes* on page 1142.

#### Prototype

```
void LISTVIEW_SetOverlap(LISTVIEW_Handle hObj,
                        unsigned          Overlap,
                        int               Period,
                        U8                Flags);
```

#### Parameters

Parameter	Description
<code>hObj</code>	Handle of LISTVIEW widget.
<code>Overlap</code>	Overlapping distance in pixels.
<code>Period</code>	<code>Period</code> in ms for moving back the list when it was released after it was dragged into the overlap area.
<code>Flags</code>	OR-combination of overlap flags: <code>WM_MOTION_OVERLAP_TOP</code> to enable overlap on the top edge. <code>WM_MOTION_OVERLAP_BOTTOM</code> to enable overlap on the bottom edge.

### 7.2.17.5.1.75 LISTVIEW\_SetOwnerDraw()

#### Description

Sets an application defined owner draw function for the widget which is responsible for drawing a cell.

#### Prototype

```
void LISTVIEW_SetOwnerDraw(LISTVIEW_Handle hObj,
                           WIDGET_DRAW_ITEM_FUNC * pfOwnerDraw);
```

#### Parameters

Parameter	Description
<code>hObj</code>	Handle to a LISTVIEW widget
<code>pfOwnerDraw</code>	Pointer to owner draw function.

#### Supported commands

- WIDGET\_ITEM\_GET\_XSIZE
- WIDGET\_ITEM\_GET\_YSIZE
- WIDGET\_ITEM\_DRAW
- WIDGET\_ITEM\_DRAW\_BACKGROUND

#### Additional information

This function sets a pointer to an application defined function which will be called by the widget when a cell has to be drawn or when the x or y size of a item is needed. It gives you the possibility to draw anything as data item, not just plain text. `pfDrawItem` is a pointer to an application-defined function of type `WIDGET_DRAW_ITEM_FUNC` which is explained at the beginning of the chapter. Also, please refer to `LISTVIEW_OwnerDraw()`.



### 7.2.17.5.1.76 LISTVIEW\_SetRBorder()

Before			After		
Column 0	Column 1	Column 2	Column 0	Column 1	Column 2
Item 0/0	Item 1/0	Item 2/0	Item 0/0	Item 1/0	Item 2/0
Item 0/1	Item 1/1	Item 2/1	Item 0/1	Item 1/1	Item 2/1
Item 0/2	Item 1/2	Item 2/2	Item 0/2	Item 1/2	Item 2/2
Item 0/3	Item 1/3	Item 2/3	Item 0/3	Item 1/3	Item 2/3

#### Description

Sets the number of pixels used for the right border within each cell of the LISTVIEW widget.

#### Prototype

```
void LISTVIEW_SetRBorder(LISTVIEW_Handle hObj,
                        unsigned         BorderSize);
```

#### Parameters

Parameter	Description
<code>hObj</code>	Handle to a LISTVIEW widget
<code>BorderSize</code>	Number of pixels to be used.

#### Additional information

Using this function has no effect to the header widget used by the listview.

### 7.2.17.5.1.77 LISTVIEW\_SetRowHeight()

#### Description

Sets a constant row height.

#### Prototype

```
unsigned LISTVIEW_SetRowHeight(LISTVIEW_Handle hObj,  
                               unsigned RowHeight);
```

#### Parameters

Parameter	Description
<code>hObj</code>	Handle to a LISTVIEW widget
<code>RowHeight</code>	Constant row height to set. In case <code>RowHeight = 0</code> , the height of the current font is used instead.

#### Return value

Previous value of the row height set by this function.

#### Additional information

Per default the height of the rows depends on the height of the used font.

### 7.2.17.5.1.78 LISTVIEW\_SetScrollPos()

#### Description

Scrolls the LISTVIEW to a given column and row. The specified cell will appear in the upper-left corner of the widget.

#### Prototype

```
void LISTVIEW_SetScrollPos(LISTVIEW_Handle hObj,  
                           unsigned Col,  
                           unsigned Row);
```

#### Parameters

Parameter	Description
<code>hObj</code>	Handle to a LISTVIEW widget
<code>Col</code>	Column to scroll to.
<code>Row</code>	Row to scroll to.

### 7.2.17.5.1.79 LISTVIEW\_SetScrollStepH()

#### Description

Sets a distance in pixels for horizontal scrolling. This distance is applied when using arrow keys or clicking the left or right arrows on the scrollbar.

Setting the distance to 0 will enable column-wise scrolling.

#### Prototype

```
int LISTVIEW_SetScrollStepH(LISTVIEW_Handle hObj,  
                             int Dist);
```

#### Parameters

Parameter	Description
<code>hObj</code>	Handle to a LISTVIEW widget
<code>Dist</code>	> 0: Distance in px for horizontal scrolling. = 0: Column-wise scrolling.

#### Return value

≠ -1    Old value.  
= -1    Invalid LISTVIEW handle or invalid `Dist` value.

### 7.2.17.5.1.80 LISTVIEW\_SetSel()

#### Description

Sets the selected row of a specified LISTVIEW widget.

#### Prototype

```
void LISTVIEW_SetSel(LISTVIEW_Handle hObj,  
                    int NewSel);
```

#### Parameters

Parameter	Description
<code>hObj</code>	Handle to a LISTVIEW widget
<code>Sel</code>	Row to be selected.

#### Additional information

Pass -1 as parameter `Sel` to select no row.

### 7.2.17.5.1.81 LISTVIEW\_SetSelCol()

#### Description

Sets the selected column of the given LISTVIEW widget. Makes sense in combination with LISTVIEW\_EnableCellSelect().

#### Prototype

```
void LISTVIEW_SetSelCol(LISTVIEW_Handle hObj,  
                        int NewCol);
```

#### Parameters

Parameter	Description
<a href="#">hObj</a>	Handle to a LISTVIEW widget
<a href="#">NewCol</a>	Column to be selected.

### 7.2.17.5.1.82 LISTVIEW\_SetSelUnsorted()

#### Description

Sets the index of the currently selected row in unsorted state.

#### Prototype

```
void LISTVIEW_SetSelUnsorted(LISTVIEW_Handle hObj,  
                             int Sel);
```

#### Parameters

Parameter	Description
<code>hObj</code>	Handle to a LISTVIEW widget
<code>Sel</code>	Zero-based selection index in unsorted state.

#### Additional information

This function sets the actually index of the selected row, whereas the function `LISTVIEW_SetSel()` sets the index of the sorted row. The actual (unsorted) row index should be used in function calls as row index.

The `Sample` folder contains the example `WIDGET_SortedListview.c` which shows how to use the function.

### 7.2.17.5.1.83 LISTVIEW\_SetSort()

Before				After			
Name	Code	Balance		Name	Code	Balance	
Name 12	OEJUV	-233		Name 56	KASVW	1944	
Name 24	OEFXZ	97		Name 39	ENZKY	-2918	
Name 30	PSFAD	3745		Name 30	PSFAD	3745	
Name 29	FXTLS	-2296		Name 29	FXTLS	-2296	
Name 39	ENZKY	-2918		Name 24	OEFXZ	97	
Name 56	KASVW	1944		Name 12	OEJUV	-233	

#### Description

This function sets the column to be sorted by and the sorting order.

#### Prototype

```
unsigned LISTVIEW_SetSort(LISTVIEW_Handle hObj,
                          unsigned        Column,
                          unsigned        Reverse);
```

#### Parameters

Parameter	Description
<code>hObj</code>	Handle to a LISTVIEW widget
<code>Column</code>	<code>Column</code> to be sorted by.
<code>Reverse</code>	0 for normal sorting order (greatest element at the top), 1 for reverse order.

#### Return value

0 if function was successfully  
1 if not.

#### Additional information

Before calling this function a compare function needs to be set for the desired column. For details about how to set a compare function, refer to `LISTVIEW_SetCompareFunc()`. The `Sample` folder contains the example `WIDGET_SortedListview.c` which shows how to use the function.



### 7.2.17.5.1.84 LISTVIEW\_SetTextAlign()

#### Description

Sets the alignment for the given column.

#### Prototype

```
void LISTVIEW_SetTextAlign(LISTVIEW_Handle hObj,  
                           unsigned int   Index,  
                           int           Align);
```

#### Parameters

Parameter	Description
<code>hObj</code>	Handle to a LISTVIEW widget
<code>Index</code>	Number of column
<code>Align</code>	Text alignment mode to set. List of flags can be found under <i>Text alignment flags</i> on page 286.

### 7.2.17.5.1.85 LISTVIEW\_SetTextColor()

#### Description

Sets the text color of the given LISTVIEW widget.

#### Prototype

```
void LISTVIEW_SetTextColor(LISTVIEW_Handle hObj,  
                           unsigned int   Index,  
                           GUI_COLOR     Color);
```

#### Parameters

Parameter	Description
<a href="#">hObj</a>	Handle to a LISTVIEW widget
<a href="#">Index</a>	<a href="#">Index</a> for text color. See <i>LISTVIEW color indexes</i> on page 1870 for a full list of permitted values.
<a href="#">Color</a>	<a href="#">Color</a> to be set.

### 7.2.17.5.1.86 LISTVIEW\_SetUserData()

#### Description

Prototype explained at the beginning of the chapter as `<WIDGET>_SetUserData()` on page 1166.

### 7.2.17.5.1.87 LISTVIEW\_SetUserDataRow()

#### Description

Sets the user data of the given row.

#### Prototype

```
void LISTVIEW_SetUserDataRow(LISTVIEW_Handle hObj,  
                             unsigned Row,  
                             U32 UserData);
```

#### Parameters

Parameter	Description
<a href="#">hObj</a>	Handle to a LISTVIEW widget
<a href="#">Row</a>	<a href="#">Row</a> for which the user data should be set
<a href="#">UserData</a>	Value to be associated with the row.

#### Additional information

Sets the 32-bit value associated with the row. Each row has a corresponding 32-bit value intended for use by the application.

### 7.2.17.5.1.88 LISTVIEW\_SetWrapMode()

#### Description

Sets the wrapping mode which should be used for the cells of the given LISTVIEW widget.

#### Prototype

```
void LISTVIEW_SetWrapMode(LISTVIEW_Handle hObj,  
                           GUI_WRAPMODE  WrapMode);
```

#### Parameters

Parameter	Description
<a href="#">hObj</a>	Handle to a LISTVIEW widget
<a href="#">WrapMode</a>	See table below.

## 7.2.17.5.2 Defines

### 7.2.17.5.2.1 LISTVIEW color indexes

#### Description

Color indexes to be used by the LISTVIEW widget.

#### Definition

```
#define LISTVIEW_CI_UNSEL      0
#define LISTVIEW_CI_SEL       1
#define LISTVIEW_CI_SELFOCUS  2
#define LISTVIEW_CI_DISABLED  3
```

#### Symbols

Definition	Description
<a href="#">LISTVIEW_CI_UNSEL</a>	Unselected element.
<a href="#">LISTVIEW_CI_SEL</a>	Selected element, without focus.
<a href="#">LISTVIEW_CI_SELFOCUS</a>	Selected element, with focus.
<a href="#">LISTVIEW_CI_DISABLED</a>	Disabled element.

## 7.2.17.6 Example

The `Sample` folder contains the following example which shows how the widget can be used:

- `WIDGET_ListView.c`

Note that several other examples also make use of this widget and may also be helpful to get familiar with the widget.

### Screenshot of `WIDGET_ListView.c`

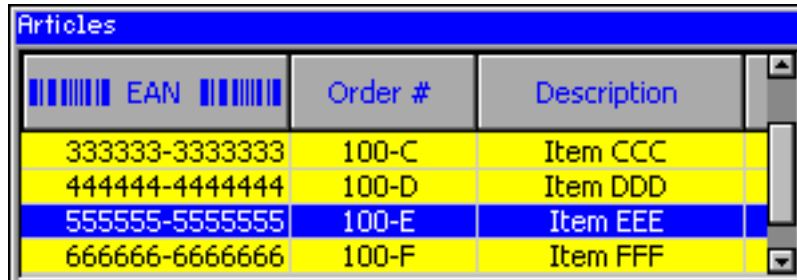

The screenshot shows a ListView widget titled "Articles". It contains a table with three columns: "EAN", "Order #", and "Description". The table has four rows of data. The first row is highlighted in yellow, the second in blue, the third in yellow, and the fourth in blue. The widget has a scroll bar on the right side.

EAN	Order #	Description
333333-3333333	100-C	Item CCC
444444-4444444	100-D	Item DDD
555555-5555555	100-E	Item EEE
666666-6666666	100-F	Item FFF

## 7.2.18 MENU: Menu widget

The MENU widget can be used to create several kinds of MENUs. Each MENU item represents an application command or a submenu. MENUs can be shown horizontally and/or vertically. Menu items can be grouped using separators. Separators are supported for horizontal and vertical MENUs. Selecting a MENU item sends a WM\_MENU message to the owner of the MENU or opens a submenu. If mouse support is enabled the MENU widget reacts on moving the mouse over the items of a MENU widget. The shipment of emWin contains an application example which shows how to use the MENU widget. It can be found under Sample\Application\Reversi.c. The table below shows the appearance of a horizontal MENU widget with a vertical submenu:

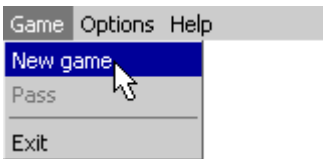
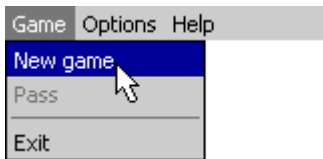
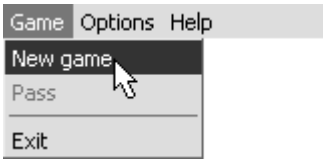
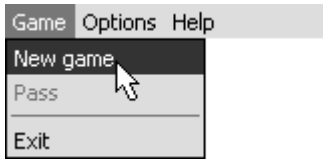
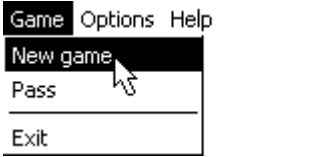
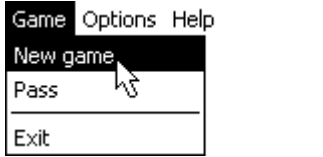
Description	Menu using WIDGET_Effect_3D1L	Menu using WIDGET_Effect_Simple
Color display (8666 mode)		
Monochrome display (16 gray scales)		
Black/white display		

**Note**

All MENU-related routines are located in the file(s) MENU\*.c, MENU.h.  
All identifiers are prefixed MENU.

### Skining...

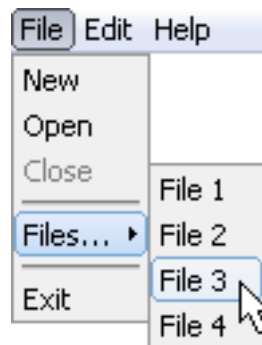

...is available for this widget. The screenshot above shows the widget using the default skin. Details can be found in the chapter *Skining* on page 2800.

**Note**

This widget uses skinning. To change the look it is recommended to use the function `<WIDGET>_SetSkinFlexProps()`. Other functions to change the look might work only with the classic skin.



## 7.2.18.1 Menu messages

To inform its owner about selecting an item or opening a submenu the MENU widget sends a message of type `WM_MENU` to its owner.

### 7.2.18.1.1 WM\_MENU

#### Description

This message is sent to inform the owner of a MENU about selecting an item or opening a submenu. Disabled MENU items will not send this message.

#### Data

The `Data.p` pointer of the message points to a `MENU_MSG_DATA` structure.

#### Example

The following example shows how to react on a `WM_MENU` message:

```
void Callback(WM_MESSAGE * pMsg) {
    MENU_MSG_DATA * pData;
    WM_HWIN hWin = pMsg->hWin;
    switch (pMsg->MsgId) {
    case WM_MENU:
        pData = (MENU_MSG_DATA *)pMsg->Data.p;
        switch (pData->MsgType) {
        case MENU_ON_ITEMACTIVATE:
            _UpdateStatusBar(pData->ItemId);
            break;
        case MENU_ON_INITMENU:
            _OnInitMenu();
            break;
        case MENU_ON_ITEMSELECT:
            switch (pData->ItemId) {
            case ID_MENU_ITEM0:
                ... /* React on selection of menu item 0 */
                break;
            case ID_MENU_ITEM1:
                ... /* React on selection of menu item 1 */
                break;
            case ...
                ...
            }
            break;
        }
        break;
    default:
        MENU_Callback(pMsg);
    }
}
```

## 7.2.18.2 Configuration options

Type	Macro	Default	Description
N	<code>MENU_BKCOLOR0_DEFAULT</code>	<code>GUI_LIGHTGRAY</code>	Background color for enabled and unselected items.
N	<code>MENU_BKCOLOR1_DEFAULT</code>	<code>0x980000</code>	Background color for enabled and selected items.
N	<code>MENU_BKCOLOR2_DEFAULT</code>	<code>GUI_LIGHTGRAY</code>	Background color for disabled items.
N	<code>MENU_BKCOLOR3_DEFAULT</code>	<code>0x980000</code>	Background color for disabled and selected items.

Type	Macro	Default	Description
N	MENU_BKCOLOR4_DEFAULT	0x7C7C7C	Background color for active submenu items.
N	MENU_BORDER_BOTTOM_DEFAULT	2	Border between item text and item bottom.
N	MENU_BORDER_LEFT_DEFAULT	4	Border between item text and left edge of item.
N	MENU_BORDER_RIGHT_DEFAULT	4	Border between item text and right edge of item.
N	MENU_BORDER_TOP_DEFAULT	2	Border between item text and item top.
S	MENU_EFFECT_DEFAULT	WIDGET_Effect_3D1L	Default effect.
S	MENU_FONT_DEFAULT	GUI_Font13_1	Font used.
N	MENU_TEXTCOLOR0_DEFAULT	GUI_BLACK	Text color for enabled and unselected items.
N	MENU_TEXTCOLOR1_DEFAULT	GUI_WHITE	Text color for enabled and selected items.
N	MENU_TEXTCOLOR2_DEFAULT	0x7C7C7C	Text color for disabled items.
N	MENU_TEXTCOLOR3_DEFAULT	GUI_LIGHTGRAY	Text color for disabled and selected items.
N	MENU_TEXTCOLOR4_DEFAULT	GUI_WHITE	Text color for active submenu items.

### 7.2.18.3 Keyboard reaction

The widget reacts to the following keys if it has the input focus:

Key	Reaction
GUI_KEY_RIGHT	<ul style="list-style-type: none"> <li>• If the MENU is horizontal, the selection moves one item to the right.</li> <li>• If the MENU is vertical and the current item is a submenu, the submenu opens and the input focus moves to the submenu.</li> <li>• If the MENU is vertical and the current item is not a submenu and the top level MENU is horizontal, the next item of the top level MENU opens and the input focus moves to it.</li> </ul>
GUI_KEY_LEFT	<ul style="list-style-type: none"> <li>• If the MENU is horizontal the selection moves one item to the left.</li> <li>• If the MENU is vertical and the MENU is not the top level MENU, the current MENU closes and the focus moves to the previous MENU. If the previous MENU is horizontal the previous submenu of it opens and the focus moves to the previous submenu.</li> </ul>
GUI_KEY_DOWN	<ul style="list-style-type: none"> <li>• If the MENU is horizontal and the current MENU item is a submenu this submenu opens.</li> <li>• If the MENU is vertical, the selection moves to the next item.</li> </ul>
GUI_KEY_UP	<ul style="list-style-type: none"> <li>• If the MENU is vertical, the selection moves to the previous item.</li> </ul>
GUI_KEY_ESCAPE	<ul style="list-style-type: none"> <li>• If the MENU is not the top level MENU the current MENU will be closed and the focus moves to the previous MENU.</li> <li>• If the MENU is the top level MENU, the current MENU item becomes unselected.</li> </ul>

Key	Reaction
GUI_KEY_ENTER	<ul style="list-style-type: none"> <li>If the current MENU item is a submenu, the submenu opens and the focus moves to the submenu.</li> <li>If the current MENU item is not a submenu, all submenus of the top level MENU closes and a <code>MENU_ON_ITEMSELECT</code> message will be sent to the owner of the MENU.</li> </ul>

## 7.2.18.4 MENU API

The table below lists the available emWin MENU-related routines in alphabetical order. Detailed descriptions of the routines follow.

### Functions

Routine	Description
<code>MENU_AddItem()</code>	Adds an item to an existing MENU widget.
<code>MENU_Attach()</code>	Attaches the given MENU widget at the given position with the given size to a specified WINDOW.
<code>MENU_CreateEx()</code>	Creates a MENU widget.
<code>MENU_CreateIndirect()</code>	Creates a MENU widget from a resource table entry.
<code>MENU_CreateUser()</code>	Creates a MENU widget using extra bytes as user data.
<code>MENU_DeleteItem()</code>	Deletes a given MENU item from a MENU widget.
<code>MENU_DisableItem()</code>	Disables the given MENU item.
<code>MENU_EnableItem()</code>	Enables the given MENU item.
<code>MENU_GetBkColor()</code>	Returns the background color of the widget.
<code>MENU_GetDefaultBkColor()</code>	Returns the default background color used to draw new MENU items.
<code>MENU_GetDefaultBorderSize()</code>	Returns the default border size used for new MENU widgets.
<code>MENU_GetDefaultEffect()</code>	Returns the default effect for new MENU widgets.
<code>MENU_GetDefaultFont()</code>	Returns a pointer to the default font used to display the MENU item text of new MENU widgets.
<code>MENU_GetDefaultTextColor()</code>	Returns the default text color for new MENU widgets.
<code>MENU_GetFont()</code>	Returns the font of the widget.
<code>MENU_GetItem()</code>	Retrieves information about the given MENU item.
<code>MENU_GetItemText()</code>	Returns the text of the given MENU item.
<code>MENU_GetNumItems()</code>	Returns the number of items of the given MENU widget.
<code>MENU_GetOwner()</code>	Returns the owner WINDOW of the given MENU widget.
<code>MENU_GetTextColor()</code>	Returns the text color of the widget.
<code>MENU_GetUserData()</code>	Retrieves the data set with <code>MENU_SetUserData()</code> .
<code>MENU_InsertItem()</code>	Inserts a MENU item at the given position.
<code>MENU_Popup()</code>	Opens the given MENU at the given position.
<code>MENU_SetBkColor()</code>	Sets the background color of the given MENU widget.
<code>MENU_SetBorderSize()</code>	Sets the border size of the given MENU widget.

Routine	Description
<code>MENU_SetDefaultBkColor()</code>	Sets the default background color used to draw new MENU items.
<code>MENU_SetDefaultBorderSize()</code>	Sets the default border size used for new MENU widgets.
<code>MENU_SetDefaultEffect()</code>	Sets the default effect for new MENU widgets.
<code>MENU_SetDefaultFont()</code>	Sets the pointer to the default font used to display the MENU item text of new MENU widgets.
<code>MENU_SetDefaultTextColor()</code>	Sets the default text color for new MENU widgets.
<code>MENU_SetFont()</code>	Sets the pointer to the font used to display the item text of the MENU widget.
<code>MENU_SetItem()</code>	Sets the item information for the given MENU item.
<code>MENU_SetOwner()</code>	Sets the owner WINDOW of the MENU widget that will be informed with <code>WM_MENU</code> messages.
<code>MENU_SetSel()</code>	Sets the selected item of the given MENU widget.
<code>MENU_SetTextColor()</code>	Sets the text color of the given MENU widget.
<code>MENU_SetUserData()</code>	Sets the extra data of a MENU widget.

### Data structures



Structure	Description
<code>MENU_ITEM_DATA</code>	This structure serves as a container to set or retrieve information about MENU items.
<code>MENU_MSG_DATA</code>	This structure is used in conjunction with the <code>WM_MENU</code> message, specific to the MENU widget.

### Defines

Group of defines	Description
<code>MENU border indexes</code>	Border indexes used by functions to set the border properties of a MENU widget.
<code>MENU color indexes</code>	Color indexes used by the MENU widget.
<code>MENU create flags</code>	Create flags used by <code>MENU_CreateEx()</code> .
<code>MENU item flags</code>	Flags used by the <code>MENU_ITEM_DATA</code> structure.
<code>MENU message types</code>	Types of messages sent via the <code>MENU_MSG_DATA</code> structure with the <code>WM_MENU</code> message.

## 7.2.18.4.1 Functions

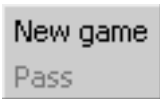
### 7.2.18.4.1.1 MENU\_AddItem()

Before	After
	

#### Description

This function adds a new item to the end of the given MENU widget.

#### Prototype

```
void MENU_AddItem(    MENU_Handle    hObj,
                    const MENU_ITEM_DATA * pItemData);
```

#### Parameters

Parameter	Description
<code>hObj</code>	Handle of LISTWHEEL widget.
<code>pItemData</code>	Pointer to a MENU_ITEM_DATA structure containing the information of the new item.

#### Additional information

If using a MENU widget with several submenus the Id of the MENU items should be unique. Different submenus should not contain MENU items with the same IDs. When adding items to a MENU widget and no fixed sizes are used the size of the MENU will be adapted. Refer to *MENU\_ITEM\_DATA* on page 1913.

### 7.2.18.4.1.2 MENU\_Attach()

#### Description

Attaches the given MENU widget at the given position with the given size to a specified WINDOW.

#### Prototype

```
void MENU_Attach(MENU_Handle hObj,
                 WM_HWIN    hDestWin,
                 int         x,
                 int         y,
                 int         xSize,
                 int         ySize,
                 int         Flags);
```

#### Parameters

Parameter	Description
<code>hObj</code>	Handle of MENU widget.
<code>hDestWin</code>	Handle to the WINDOW to which the MENU widget should be attached.
<code>x</code>	X position in window coordinates of the MENU widget.
<code>y</code>	Y position in window coordinates of the MENU widget.
<code>ySize</code>	Fixed Y size of the MENU. For details, refer to <code>MENU_CreateEx()</code> .
<code>xSize</code>	Fixed X size of the MENU. For details, refer to <code>MENU_CreateEx()</code> .
<code>Flags</code>	Reserved for future use

#### Additional information

After creating a MENU widget this function can be used to attach the MENU widget to an existing window.

### 7.2.18.4.1.3 MENU\_CreateEx()

#### Description

Creates a MENU widget of a specified size at a specified location.

#### Prototype

```
MENU_Handle MENU_CreateEx(int    x0,
                          int    y0,
                          int    xSize,
                          int    ySize,
                          WM_HWIN hParent,
                          int    WinFlags,
                          int    ExFlags,
                          int    Id);
```

#### Parameters

Parameter	Description
<code>x0</code>	Leftmost pixel of the widget (in parent coordinates).
<code>y0</code>	Topmost pixel of the widget (in parent coordinates).
<code>xSize</code>	Fixed horizontal size of the widget (in pixels). 0 if MENU should handle the <code>xSize</code> .
<code>ySize</code>	Fixed vertical size of the widget (in pixels). 0 if MENU should handle the <code>ySize</code> .
<code>hParent</code>	Handle of parent window. If 0, the new widget will be a child of the desktop (top-level window). In some cases it can be useful to create the MENU widget in 'unattached' state and attach it later to an existing window. For this case <code>WM_UNATTACHED</code> can be used as parameter.
<code>WinFlags</code>	Window create flags. Typically <code>WM_CF_SHOW</code> in order to make the widget visible immediately (refer to <i>Window create flags</i> on page 1146 for a list of available parameter values).
<code>ExFlags</code>	See <i>MENU create flags</i> on page 1917.
<code>Id</code>	Window ID of the widget.

#### Return value

Handle of the created MENU widget; 0 if the function fails.

#### Additional information

The parameters `xSize` and/or `ySize` specifies if a fixed width and/or height should be used for the MENU widget.

If these parameters are > 0, fixed sizes should be used. If for example the MENU should be attached as a horizontal MENU to the top of a WINDOW it can be necessary to use a fixed X size which covers the whole top of the window. In this case the parameter `xSize` can be used to set a fixed X size of the MENU. When attaching or deleting items of a MENU with a fixed size the size of the widget does not change. If the values are 0, the MENU handles its size itself. That means the size of the MENU depends on the size of the current MENU items of a MENU widget. If items are added or removed the size of the widget will be adapted.

#### 7.2.18.4.1.4 MENU\_CreateIndirect()

##### Description

The prototype of this function is explained at the beginning of this chapter. Details can be found in the description of the function `<WIDGET>_CreateIndirect()` on page 1161. The element `Para` of the according `GUI_WIDGET_CREATE_INFO` structure is not used. The element `Flags` is used according to the parameter `ExFlags` of the function `MENU_CreateEx()`.





### 7.2.18.4.1.5 MENU\_CreateUser()

#### Description

Prototype explained at the beginning of the chapter as `<WIDGET>_CreateUser()` on page 1162. For a detailed description of the parameters the function `MENU_CreateEx()` can be referred to.

### 7.2.18.4.1.6 MENU\_Deleteltem()

Before	After
	

#### Description

Deletes a given MENU item from a MENU widget.

#### Prototype

```
void MENU_DeleteItem(MENU_Handle hObj,
                    U16          ItemId);
```



#### Parameters

Parameter	Description
<code>hObj</code>	Handle of MENU widget.
<code>ItemId</code>	Id of the MENU item to be deleted.

#### Additional information

If the item does not exist the function returns immediately. When deleting items from a MENU widget and no fixed sizes are used the window size will be adapted.

### 7.2.18.4.1.7 MENU\_DisableItem()

Before	After
	

#### Description

Disables the given MENU item.

#### Prototype

```
void MENU_DisableItem(MENU_Handle hObj,
                     U16          ItemId);
```

#### Parameters

Parameter	Description
<code>hObj</code>	Handle of MENU widget.
<code>ItemId</code>	Id of the MENU item to be disabled.

#### Additional information

If a disabled MENU item is selected, the MENU widget does not send the `WM_MENU` message to the owner. A disabled submenu item can not be opened.

### 7.2.18.4.1.8 MENU\_EnableItem()

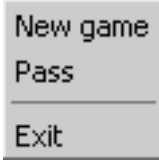
Before	After
	

#### Description

Enables the given MENU item.

#### Prototype

```
void MENU_EnableItem(MENU_Handle hObj,
                    U16          ItemId);
```

#### Parameters

Parameter	Description
<code>hObj</code>	Handle of MENU widget.
<code>ItemId</code>	Id of the MENU item to be enabled.

#### Additional information

For details, refer to `MENU_DisableItem()`.

### 7.2.18.4.1.9 MENU\_GetBkColor()

#### Description

Returns the background color of the widget.

#### Prototype

```
GUI_COLOR MENU_GetBkColor(MENU_Handle hObj,  
                          unsigned      ColorIndex);
```

#### Parameters

Parameter	Description
<a href="#">hObj</a>	Handle of MENU widget.
<a href="#">Index</a>	See <i>MENU color indexes</i> on page 1916 for a full list of permitted values.

#### Return value

The background color of the given widget.

#### 7.2.18.4.1.10 MENU\_GetDefaultBkColor()

##### Description

Returns the default background color used to draw new MENU items.

##### Prototype

```
GUI_COLOR MENU_GetDefaultBkColor(unsigned ColorIndex);
```

##### Parameters

Parameter	Description
<code>ColorIndex</code>	See <i>MENU color indexes</i> on page 1916 for a full list of permitted values.

##### Return value

Default background color used to draw new MENU items.

##### Additional information

For details, refer to `MENU_SetBkColor()`.

### 7.2.18.4.1.11 MENU\_GetDefaultBorderSize()

#### Description

Returns the default border size used for new MENU widgets.

#### Prototype

```
U8 MENU_GetDefaultBorderSize(unsigned BorderIndex);
```

#### Parameters

Parameter	Description
<a href="#">BorderIndex</a>	See <i>MENU border indexes</i> on page 1915 for a full list of permitted values.

#### Return value

Default border size used for new MENU widgets.

#### Additional information

For details, refer to `MENU_SetBorderSize()`.

#### 7.2.18.4.1.12 MENU\_GetDefaultEffect()

##### Description

Returns the default effect for new MENU widgets.

##### Prototype

```
WIDGET_EFFECT *MENU_GetDefaultEffect(void);
```

##### Return value

The result of the function is a pointer to a WIDGET\_EFFECT structure.

##### Additional information

For more information, refer to WIDGET\_SetDefaultEffect().



### 7.2.18.4.1.13 MENU\_GetDefaultFont()

#### Description

Returns a pointer to the default font used to display the MENU item text of new MENU widgets.

#### Prototype

```
GUI_FONT *MENU_GetDefaultFont(void);
```

#### Return value

Pointer to the default font used to display the MENU item text of new MENU widgets.

#### 7.2.18.4.1.14 MENU\_GetDefaultTextColor()

##### Description

Returns the default text color for new MENU widgets.

##### Prototype

```
GUI_COLOR MENU_GetDefaultTextColor(unsigned ColorIndex);
```

##### Parameters

Parameter	Description
<code>ColorIndex</code>	See <i>MENU color indexes</i> on page 1916 for a full list of permitted values.

##### Return value

Default text color for new MENU widgets.

##### Additional information

For details, refer to `MENU_SetDefaultTextColor()`.

### 7.2.18.4.1.15 MENU\_GetFont()

#### Description

Returns the font of the widget.

#### Prototype

```
GUI_FONT *MENU_GetFont(MENU_Handle hObj);
```

#### Parameters

Parameter	Description
<a href="#">hObj</a>	Handle of MENU widget.

#### Return value

Pointer to the font of the given widget.

### 7.2.18.4.1.16 MENU\_GetItem()

#### Description

Retrieves information about the given MENU item.

#### Prototype

```
void MENU_GetItem(MENU_Handle    hObj,
                  U16            ItemId,
                  MENU_ITEM_DATA * pItemData);
```

#### Parameters

Parameter	Description
<code>hObj</code>	Handle of MENU widget.
<code>ItemId</code>	Id of the requested MENU item.
<code>pItemData</code>	Pointer to a MENU_ITEM_DATA structure to be filled by the function.

#### Additional information

If using a MENU widget with several submenus the handle of the widget needs to be the handle of the menu/submenu containing the requested item or the handle of a higher menu/submenu.

The function sets the element `pText` of the MENU\_ITEM\_DATA structure to 0. To retrieve the MENU item text the function `MENU_GetItemText()` should be used. Refer to the beginning of the MENU chapter for details about the MENU\_ITEM\_DATA data structure.

### 7.2.18.4.1.17 MENU\_GetItemText()

#### Description

Returns the text of the given MENU item.

#### Prototype

```
void MENU_GetItemText(MENU_Handle  hObj,  
                     U16          ItemId,  
                     char          * pBuffer,  
                     unsigned      BufferSize);
```

#### Parameters

Parameter	Description
<a href="#">hObj</a>	Handle of MENU widget.
<a href="#">ItemId</a>	Id of the requested MENU item.
<a href="#">pBuffer</a>	Buffer to be filled by the function.
<a href="#">BufferSize</a>	Maximum number of bytes to be retrieved.

### 7.2.18.4.1.18 MENU\_GetNumItems()

#### Description

Returns the number of items of the given MENU widget.

#### Prototype

```
unsigned MENU_GetNumItems(MENU_Handle hObj);
```

#### Parameters

Parameter	Description
<a href="#">hObj</a>	Handle of MENU widget.

#### Return value

Number of items of the given MENU widget.

### 7.2.18.4.1.19 MENU\_GetOwner()

#### Description

Returns the owner WINDOW of the given MENU widget.

#### Prototype

```
WM_HWIN MENU_GetOwner(MENU_Handle hObj);
```

#### Parameters

Parameter	Description
<a href="#">hObj</a>	Handle of MENU widget.

#### Return value

Owner WINDOW of the given MENU widget.

### 7.2.18.4.1.20 MENU\_GetTextColor()

#### Description

Returns the text color of the widget.

#### Prototype

```
GUI_COLOR MENU_GetTextColor(MENU_Handle hObj,  
                             unsigned      ColorIndex);
```

#### Parameters

Parameter	Description
<a href="#">hObj</a>	Handle of MENU widget.
<a href="#">Index</a>	See <i>MENU color indexes</i> on page 1916 for a full list of permitted values.

#### Return value

The text color of the given widget.





#### 7.2.18.4.1.21 MENU\_GetUserData()

##### **Description**

Prototype explained at the beginning of the chapter as `<WIDGET>_GetUserData()` on page 1165.

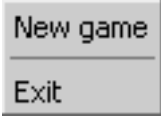
### 7.2.18.4.1.22 MENU\_InsertItem()

Before	After
	

#### Description

Inserts a MENU item at the given position.

#### Prototype

```
void MENU_InsertItem(    MENU_Handle    hObj,
                        U16                ItemId,
                        const MENU_ITEM_DATA * pItemData);
```

#### Parameters

Parameter	Description
<code>hObj</code>	Handle of MENU widget.
<code>ItemId</code>	Id of the MENU item the new item should be inserted before.
<code>pItemData</code>	Pointer to a MENU_ITEM_DATA structure containing the information of the new item.

### 7.2.18.4.1.23 MENU\_Popup()

#### Description

Opens the given MENU at the given position. After selecting a MENU item or after touching the display outside the MENU the popup MENU will be closed.

#### Prototype

```
void MENU_Popup(MENU_Handle hObj,
                WM_HWIN    hDestWin,
                int         x,
                int         y,
                int         xSize,
                int         ySize,
                int         Flags);
```

#### Parameters

Parameter	Description
<code>hObj</code>	Handle of MENU widget.
<code>hDestWin</code>	Handle to the window to which the MENU should be attached.
<code>x</code>	X position in window coordinates of the MENU widget.
<code>y</code>	Y position in window coordinates of the MENU widget.
<code>xSize</code>	Fixed X size of the MENU. For details, refer to <code>MENU_CreateEx()</code> .
<code>ySize</code>	Fixed Y size of the MENU. For details, refer to <code>MENU_CreateEx()</code> .
<code>Flags</code>	Reserved for future use

#### Additional information

After selecting a MENU item or after touching the display outside the popup MENU the MENU will be closed. Note that the MENU will not be deleted automatically. The `Sample` folder contains the example `WIDGET_PopupMenu.c` which shows how to use the function.

#### 7.2.18.4.1.24 MENU\_SetBkColor()

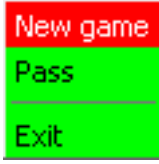
Before	After
	

### Description

Sets the background color of the given MENU widget.

### Prototype

```
void MENU_SetBkColor(MENU_Handle hObj,
                    unsigned   ColorIndex,
                    GUI_COLOR   Color);
```

### Parameters

Parameter	Description
<code>hObj</code>	Handle of MENU widget.
<code>ColorIndex</code>	See <i>MENU color indexes</i> on page 1916 for a full list of permitted values.
<code>Color</code>	<code>Color</code> to be used.

### 7.2.18.4.1.25 MENU\_SetBorderSize()



The following code is executed between the screenshots above:

```
MENU_SetBorderSize(hMenuGame, MENU_BI_LEFT, 20);
```



The following code is executed between the screenshots above:

```
MENU_SetBorderSize(hMenu, MENU_BI_LEFT, 10);
MENU_SetBorderSize(hMenu, MENU_BI_RIGHT, 10);
```

## Description

Sets the border size of the given MENU widget.

## Prototype

```
void MENU_SetBorderSize(MENU_Handle hObj,
                        unsigned      BorderIndex,
                        U8             BorderSize);
```

## Parameters

Parameter	Description
<a href="#">hObj</a>	Handle of MENU widget.
<a href="#">BorderIndex</a>	See <i>MENU border indexes</i> on page 1915 for a full list of permitted values.
<a href="#">BorderSize</a>	Size to be used.

### 7.2.18.4.1.26 MENU\_SetDefaultBkColor()

#### Description

Sets the default background color used to draw new MENU items.

#### Prototype

```
void MENU_SetDefaultBkColor(unsigned ColorIndex,  
                             GUI_COLOR Color);
```

#### Parameters

Parameter	Description
<code>ColorIndex</code>	See <i>MENU color indexes</i> on page 1916 for a full list of permitted values.
<code>Color</code>	<code>Color</code> to be used.

#### Additional information

For details, refer to `MENU_SetBkColor()`.

### 7.2.18.4.1.27 MENU\_SetDefaultBorderSize()

#### Description

Sets the default border size used for new MENU widgets.

#### Prototype

```
void MENU_SetDefaultBorderSize(unsigned BorderIndex,  
                               U8      BorderSize);
```

#### Parameters

Parameter	Description
<a href="#">BorderIndex</a>	See <i>MENU border indexes</i> on page 1915 for a full list of permitted values.
<a href="#">BorderSize</a>	Border size to be used.

#### Additional information

For details, refer to `MENU_SetBorderSize()`.

### 7.2.18.4.1.28 MENU\_SetDefaultEffect()

#### Description

Sets the default effect for new MENU widgets.

#### Prototype

```
void MENU_SetDefaultEffect(const WIDGET_EFFECT * pEffect);
```

#### Parameters

Parameter	Description
<code>pEffect</code>	Pointer to a WIDGET_EFFECT structure.

#### Additional information

For more information, refer to `WIDGET_SetDefaultEffect()`.



### 7.2.18.4.1.29 MENU\_SetDefaultFont()

#### Description

Sets the pointer to the default font used to display the MENU item text of new MENU widgets.

#### Prototype

```
void MENU_SetDefaultFont(const GUI_FONT * pFont);
```

#### Parameters

Parameter	Description
<code>pFont</code>	Pointer to the GUI_FONT structure to be used.

#### Additional information

For details, refer to `MENU_SetFont()`.

### 7.2.18.4.1.30 MENU\_SetDefaultTextColor()

#### Description

Sets the default text color for new MENU widgets.

#### Prototype

```
void MENU_SetDefaultTextColor(unsigned ColorIndex,  
                             GUI_COLOR Color);
```



#### Parameters

Parameter	Description
<code>ColorIndex</code>	See <i>MENU color indexes</i> on page 1916 for a full list of permitted values.
<code>Color</code>	<code>Color</code> to be used

#### Additional information

For details, refer to `MENU_SetTextColor()`.

### 7.2.18.4.1.31 MENU\_SetFont()

Before	After
	

#### Description

Sets the pointer to the font used to display the item text of the MENU widget.

#### Prototype

```
void MENU_SetFont(      MENU_Handle  hObj,
                      const GUI_FONT * pFont);
```

#### Parameters

Parameter	Description
<code>hObj</code>	Handle of MENU widget.
<code>pFont</code>	Pointer to the <code>GUI_FONT</code> structure to be used.

### 7.2.18.4.1.32 MENU\_SetItem()

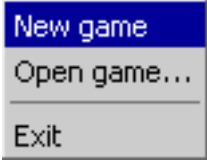
Before	After
	

#### Description

Sets the item information for the given MENU item.

#### Prototype

```
void MENU_SetItem(    MENU_Handle    hObj,
                    U16            ItemId,
                    const MENU_ITEM_DATA * pItemData);
```

#### Parameters

Parameter	Description
<code>hObj</code>	Handle of MENU widget.
<code>ItemId</code>	Id of the MENU item to be changed.
<code>pItemData</code>	Pointer to a MENU_ITEM_DATA structure containing the new information.

### 7.2.18.4.1.33 MENU\_SetOwner()

#### Description

Sets the owner WINDOW of the MENU widget that will be informed with WM\_MENU messages.

#### Prototype

```
void MENU_SetOwner(MENU_Handle hObj,  
                  WM_HWIN      hOwner);
```

#### Parameters

Parameter	Description
<code>hObj</code>	Handle of MENU widget.
<code>hOwner</code>	Handle of the owner WINDOW which should receive the WM_MENU messages of the MENU widget.

#### Additional information

If no owner is set the parent WINDOW of the MENU widget will receive WM\_MENU messages. In case the WM\_MENU messages are not intended to be sent to the parent WINDOW, this function can be used to set another recipient for the messages.

### 7.2.18.4.1.34 MENU\_SetSel()

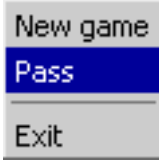
Before	After
 <p>A screenshot of a menu with three items: 'New game', 'Pass', and 'Exit'. The 'New game' item is highlighted with a blue background, indicating it is the selected item.</p>	 <p>A screenshot of a menu with three items: 'New game', 'Pass', and 'Exit'. The 'Pass' item is highlighted with a blue background, indicating it is the selected item.</p>

#### Description

Sets the selected item of the given MENU widget.

#### Prototype

```
int MENU_SetSel(MENU_Handle hObj,
               int Sel);
```

#### Parameters

Parameter	Description
<code>hObj</code>	Handle of MENU widget.
<code>Sel</code>	Zero-based index of MENU item to be selected.



#### Return value

The function returns the zero based index of the previous selected MENU item.

#### Additional information

A value <0 for parameter `Sel` deselects the MENU items.

### 7.2.18.4.1.35 MENU\_SetTextColor()

Before	After
	

#### Description

Sets the text color of the given MENU widget.

#### Prototype

```
void MENU_SetTextColor(MENU_Handle hObj,
                      unsigned   ColorIndex,
                      GUI_COLOR   Color);
```

#### Parameters

Parameter	Description
<code>hObj</code>	Handle of MENU widget.
<code>ColorIndex</code>	See <i>MENU color indexes</i> on page 1916 for a full list of permitted values.
<code>Color</code>	<code>Color</code> to be used.

### 7.2.18.4.1.36 MENU\_SetUserData()

#### Description

Prototype explained at the beginning of the chapter as `<WIDGET>_SetUserData()` on page 1166.



## 7.2.18.4.2 Data structures

### 7.2.18.4.2.1 MENU\_ITEM\_DATA

#### Description

This structure serves as a container to set or retrieve information about MENU items.

#### Type definition

```
typedef struct {  
    const char * pText;  
    U16          Id;  
    U16          Flags;  
    MENU_Handle  hSubmenu;  
} MENU_ITEM_DATA;
```

#### Structure members

Member	Description
<a href="#">pText</a>	MENU item text.
<a href="#">Id</a>	<a href="#">Id</a> of the MENU item.
<a href="#">Flags</a>	See <i>MENU item flags</i> on page 1918.
<a href="#">hSubmenu</a>	If the item represents a submenu this element contains the handle of the submenu.

### 7.2.18.4.2.2 MENU\_MSG\_DATA

#### Description

This structure is used in conjunction with the WM\_MENU message, specific to the MENU widget. The `Data.p` pointer of the message points to a MENU\_MSG\_DATA structure.

#### Type definition

```
typedef struct {  
    U16  MsgType;  
    U16  ItemId;  
} MENU_MSG_DATA;
```

#### Structure members

Member	Description
<a href="#">MsgType</a>	See <i>MENU message types</i> on page 1919.
<a href="#">ItemId</a>	Id of MENU item.

### 7.2.18.4.3 Defines

#### 7.2.18.4.3.1 MENU border indexes

##### Description

Border indexes used by functions to set the border properties of a MENU widget.

##### Definition

```
#define MENU_BI_LEFT      0
#define MENU_BI_RIGHT    1
#define MENU_BI_TOP      2
#define MENU_BI_BOTTOM   3
```

##### Symbols

Definition	Description
<a href="#">MENU_BI_LEFT</a>	Border between item text and left edge of item.
<a href="#">MENU_BI_RIGHT</a>	Border between item text and right edge of item.
<a href="#">MENU_BI_TOP</a>	Border between item text and item top.
<a href="#">MENU_BI_BOTTOM</a>	Border between item text and item bottom.

### 7.2.18.4.3.2 MENU color indexes

#### Description

Color indexes used by the MENU widget.

#### Definition

```
#define MENU_CI_ENABLED          0
#define MENU_CI_SELECTED        1
#define MENU_CI_DISABLED        2
#define MENU_CI_DISABLED_SEL    3
#define MENU_CI_ACTIVE_SUBMENU  4
```

#### Symbols

Definition	Description
<a href="#">MENU_CI_ENABLED</a>	Color of enabled and not selected MENU items.
<a href="#">MENU_CI_SELECTED</a>	Color of enabled and selected MENU items.
<a href="#">MENU_CI_DISABLED</a>	Color of disabled MENU items.
<a href="#">MENU_CI_DISABLED_SEL</a>	Color of disabled and selected MENU items.
<a href="#">MENU_CI_ACTIVE_SUB-MENU</a>	Color of active submenu items.

### 7.2.18.4.3.3 MENU create flags

#### Description

Create flags used when creating a MENU widget. These flags are used for the [ExFlags](#) parameter of `MENU_CreateEx()`.

#### Definition

```
#define MENU_CF_HORIZONTAL    (0 << 0)
#define MENU_CF_VERTICAL     (1 << 0)
```

#### Symbols

Definition	Description
<a href="#">MENU_CF_HORIZONTAL</a>	Creates a horizontal MENU.
<a href="#">MENU_CF_VERTICAL</a>	Creates a vertical MENU.

#### 7.2.18.4.3.4 MENU item flags

##### Description

Flags used by the `MENU_ITEM_DATA` structure.

##### Definition

```
#define MENU_IF_DISABLED      (1 << 0)
#define MENU_IF_SEPARATOR    (1 << 1)
```

##### Symbols

Definition	Description
<code>MENU_IF_DISABLED</code>	Indicates that item is disabled.
<code>MENU_IF_SEPARATOR</code>	Indicates that item is a separator.

### 7.2.18.4.3.5 MENU message types

#### Description

Types of messages sent with the `MsgType` parameter of the `MENU_MSG_DATA` structure. A pointer to this structure is sent via the `Data.p` pointer of a `WM_MENU` message.

#### Definition

```
#define MENU_ON_ITEMSELECT      0
#define MENU_ON_INITMENU       1
#define MENU_ON_ITEMACTIVATE   6
#define MENU_ON_ITEMPRESSED    7
```

#### Symbols

Definition	Description
<code>MENU_ON_ITEMSELECT</code>	This message is sent to the owner of a MENU immediately after a MENU item is selected. The <code>ItemId</code> element of the <code>MENU_MSG_DATA</code> structure contains the Id of the pressed MENU item.
<code>MENU_ON_INITMENU</code>	This message is sent to the owner of MENU immediately before the MENU opens. This enables the application to modify the MENU before it is shown.
<code>MENU_ON_ITEMACTIVATE</code>	The owner window of a MENU will receive this message after a MENU item has been highlighted. The message is not sent after highlighting a submenu.
<code>MENU_ON_ITEMPRESSED</code>	After pressing a MENU item this message will be sent to the owner window of the widget. It will be sent also for disabled MENU items.

## 7.2.18.5 Example

The `sample` folder contains the sample `WIDGET_Menu.c` which shows how the widget can be used. Note that several other examples also make use of this widget and may also be helpful to get familiar with the widget.

### Screenshot of `WIDGET_Menu.c`

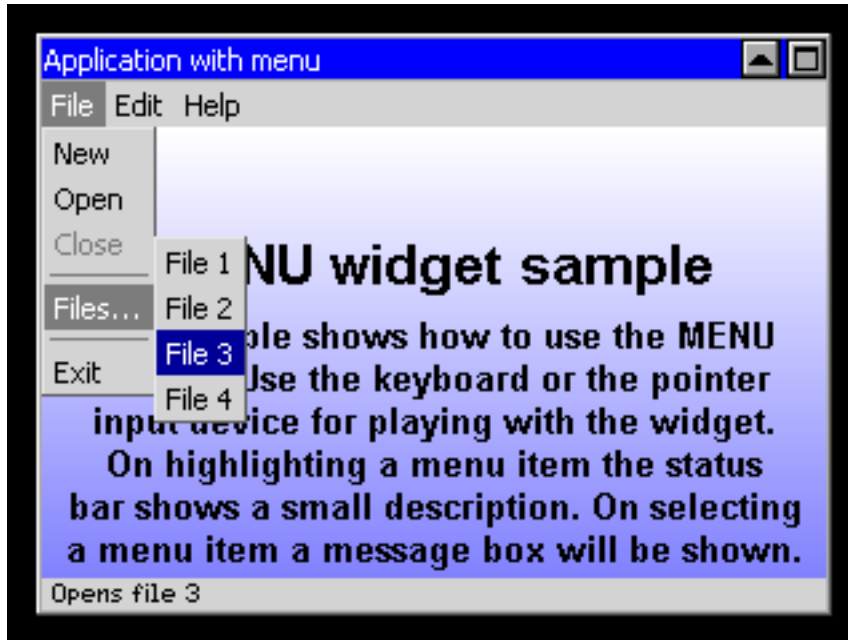



## 7.2.19 MOVIE: Movie widget

The MOVIE widget offers capability to display supported movie formats while also providing basic controls like pause, play and a progress bar.



### Note

All MOVIE-related routines are located in the file(s) `MOVIE*.c`, `MOVIE.h`.  
All identifiers are prefixed `MOVIE`.

### General information

Basic information about emWin movie files can be read in the chapter *Movies* on page 782.

The MOVIE widget supports the following input formats:

- Audio Video Interleave (\*.avi)
- emWin Movie Files (JPEG-based and bitmap-based) (\*.emf)

The **MakeMovie** tool can be used for converting a variety of input video formats into the movie formats that emWin supports. More info can be found under *Creating movies using MakeMovie.exe* on page 784.

### 7.2.19.1 Widget controls

#### Play and pause

The widget can be paused and played by tapping anywhere inside the widget area.

If the control panel is not shown, a click will first open the panel first and a second click will pause the video.

#### Center play button

While the video is paused, the MOVIE widget will show a play symbol if a bitmap has been set with `MOVIE_SetCenterBitmap()`.

#### Control panel

When the widget is clicked, the control panel will move in with an animation. The periods for moving in and out can be set with `MOVIE_SetPeriod()`.

#### Progress bar

The lower part of the control panel contains a progress bar which displays the current frame position of the movie.





Colors can be set for the left and for the right part of the progress bar using `MOVIE_SetColor()`.

By touching the progress bar or within the control panel, the user can move the current frame to a desired position, just like in commonly known video players or apps.

### Control buttons

Control buttons can be added to the control panel. A button is added by setting the corresponding bitmap(s).

The bitmaps can be added using `MOVIE_SetPanelBitmaps()`. We recommend to use alpha bitmaps. In this case the colors for the alpha bitmaps can be set with `MOVIE_SetColor()`.

Button name	Example	Description
Pause/play button		Pauses or plays the video.
Begin button		Jumps to the beginning of the video.

## 7.2.19.2 Configuration options

Type	Macro	Default	Description
N	<code>MOVIE_COLOR_CENTER_DEFAULT</code>	<code>GUI_RED</code>	Color to be used for the center play bitmap. Only used if the set bitmap is an alpha bitmap.
N	<code>MOVIE_COLOR_PANEL_DEFAULT</code>	<code>GUI_RED</code>	Color to be used for panel button bitmaps. Only used for alpha bitmaps.
N	<code>MOVIE_COLOR_PROGBAR_LEFT_DEFAULT</code>	<code>GUI_RED</code>	Color to be used to fill the left part of the progress bar.
N	<code>MOVIE_COLOR_PROGBAR_RIGHT_DEFAULT</code>	<code>GUI_GRAY</code>	Color to be used to fill the right part of the progress bar.
N	<code>MOVIE_COLOR_BK_DEFAULT</code>	<code>GUI_BLACK</code>	Color to be used to fill the background of the widget.
N	<code>MOVIE_PERIOD_SHIFT_IN_DEFAULT</code>	150	Animation period in ms for shifting in the control panel.
N	<code>MOVIE_PERIOD_SHIFT_OUT_DEFAULT</code>	300	Animation period in ms for shifting out the control panel.
N	<code>MOVIE_PERIOD_INACTIVE_DEFAULT</code>	3000	Timer period in ms it takes for the shifting out animation of the control panel to trigger.
N	<code>MOVIE_YSIZE_PANEL_DEFAULT</code>	24	Vertical size of the control panel.
N	<code>MOVIE_YSIZE_PROGBAR_DEFAULT</code>	4	Vertical size of the progress bar.
N	<code>MOVIE_SPACE_DEFAULT</code>	10	Horizontal spacing between the control panel buttons.

## 7.2.19.3 Predefined IDs

The following symbols define IDs which may be used to make MOVIE widgets distinguishable from creation.

```
#define GUI_ID_MOVIE0      0x400
#define GUI_ID_MOVIE1      0x401
#define GUI_ID_MOVIE2      0x402
#define GUI_ID_MOVIE3      0x403
#define GUI_ID_MOVIE4      0x404
#define GUI_ID_MOVIE5      0x405
#define GUI_ID_MOVIE6      0x406
#define GUI_ID_MOVIE7      0x407
#define GUI_ID_MOVIE8      0x408
```

```
#define GUI_ID_MOVIE9    0x409
```

## 7.2.19.4 MOVIE API

The table below lists the available emWin MOVIE-related routines in alphabetical order. Detailed descriptions of the routines follow.

### Functions

Routine	Description
<code>MOVIE_CreateIndirect()</code>	Creates a MOVIE widget from a resource table entry.
<code>MOVIE_CreateUser()</code>	Creates a MOVIE widget of a specified size at a specified location and allocates a given number of additional bytes.
<code>MOVIE_GetBarSize()</code>	Returns the vertical progress bar size of the widget.
<code>MOVIE_GetColor()</code>	Returns the requested color of the widget.
<code>MOVIE_GetDefaultColor()</code>	Returns the default color of the given index used for newly created MOVIE widgets.
<code>MOVIE_GetDefaultPeriod()</code>	Returns the default period of the given index used for newly created MOVIE widgets.
<code>MOVIE_GetDefaultSizeBar()</code>	Returns the default vertical size of the progress bar for newly created MOVIE widgets.
<code>MOVIE_GetDefaultSizePanel()</code>	Returns the default vertical size of the control panel for newly created MOVIE widgets.
<code>MOVIE_GetDefaultSpace()</code>	Returns the default horizontal space between the buttons in the control panel for newly created MOVIE widgets.
<code>MOVIE_GethMovie()</code>	Returns the movie handle associated with the given MOVIE widget.
<code>MOVIE_GetInfo()</code>	Fills the given <code>GUI_MOVIE_INFO</code> structure.
<code>MOVIE_GetPanelSize()</code>	Returns the vertical panel size of the widget.
<code>MOVIE_GetPeriod()</code>	Returns the requested period of the widget.
<code>MOVIE_GetSpace()</code>	Returns the horizontal space between the buttons in the control panel.
<code>MOVIE_GetUserData()</code>	Retrieves the extra data of a MOVIE widget.
<code>MOVIE_GotoFrame()</code>	The movie jumps to a requested frame.
<code>MOVIE_Pause()</code>	Pauses the movie.
<code>MOVIE_Play()</code>	Resumes/plays the movie.
<code>MOVIE_SetBarSize()</code>	Sets the vertical size of the progress bar in the control panel.
<code>MOVIE_SetCenterBitmap()</code>	Sets a new bitmap (play button) to be displayed in the widget's center while the movie is paused.
<code>MOVIE_SetColor()</code>	Sets a new color of the given color index.

Routine	Description
<code>MOVIE_SetColors()</code>	Convenience function for <code>MOVIE_SetColor()</code> that takes in all color values at once.
<code>MOVIE_SetData()</code>	Sets movie file data in ROM to the widget.
<code>MOVIE_SetDataEx()</code>	Sets external movie file data to the widget.
<code>MOVIE_SetDefaultColor()</code>	Sets a new default color of the given index for newly created MOVIE widgets.
<code>MOVIE_SetDefaultPeriod()</code>	Sets a new default period of the given index for newly created MOVIE widgets.
<code>MOVIE_SetDefaultSizeBar()</code>	Sets a new default vertical size of the progress bar for newly created MOVIE widgets.
<code>MOVIE_SetDefaultSizePanel()</code>	Sets a new default size for the control panel for newly created MOVIE widgets.
<code>MOVIE_SetDefaultSpace()</code>	Sets a new default horizontal space between the buttons in the control panel for newly created MOVIE widgets.
<code>MOVIE_SetPanelBitmaps()</code>	Sets the bitmaps displayed in the panel.
<code>MOVIE_SetPeriod()</code>	Sets a period of the given index.
<code>MOVIE_SetPeriods()</code>	Convenience function for <code>MOVIE_SetPeriod()</code> to set all periods at once.
<code>MOVIE_SetPanelSize()</code>	Sets the vertical size of the control panel.
<code>MOVIE_SetSizes()</code>	Convenience function that sets all panel sizes at once.
<code>MOVIE_SetSpace()</code>	Sets the horizontal spacing between the buttons in the control panel.
<code>MOVIE_SetUserData()</code>	Sets the extra data of a MOVIE widget.

## Defines

Group of defines	Description
<code>MOVIE_bitmap_indexes</code>	Bitmap indexes for MOVIE widgets.
<code>MOVIE_color_indexes</code>	Color indexes for MOVIE widgets.
<code>MOVIE_period_indexes</code>	Period indexes for MOVIE widgets.

## 7.2.19.4.1 Functions

### 7.2.19.4.1.1 MOVIE\_CreateIndirect()

#### Description

Prototype explained at the beginning of the chapter as `<WIDGET>_CreateIndirect()` on page 1161.

### 7.2.19.4.1.2 MOVIE\_CreateUser()

#### Description

Creates a MOVIE widget of a specified size at a specified location and allocates a given number of additional bytes.

#### Prototype

```
MOVIE_Handle MOVIE_CreateUser(int    x0,
                              int    y0,
                              int    xSize,
                              int    ySize,
                              WM_HWIN hParent,
                              int    WinFlags,
                              int    ExFlags,
                              int    Id,
                              int    NumExtraBytes);
```

#### Parameters

Parameter	Description
<code>x0</code>	Leftmost pixel of the widget (in parent coordinates).
<code>y0</code>	Topmost pixel of the widget (in parent coordinates).
<code>xSize</code>	Horizontal size of the widget (in pixels).
<code>ySize</code>	Vertical size of the widget (in pixels).
<code>hParent</code>	Handle of parent window. If 0, the new MOVIE widget will be a child of the desktop (top-level window).
<code>WinFlags</code>	Window create flags. Typically <code>WM_CF_SHOW</code> in order to make the widget visible immediately (refer to <i>Window create flags</i> on page 1146 for a list of available parameter values).
<code>ExFlags</code>	Unused, reserved for future use.
<code>Id</code>	Window ID of the widget.
<code>NumExtraBytes</code>	Number of extra bytes to be allocated.

#### Return value

- = 0      Creation of the MOVIE failed.
- ≠ 0     Handle of the created MOVIE widget.

### 7.2.19.4.1.3 MOVIE\_GetBarSize()

#### Description

Returns the vertical progress bar size of the widget.

#### Prototype

```
int MOVIE_GetBarSize(MOVIE_Handle hObj);
```

#### Parameters

Parameter	Description
<a href="#">hObj</a>	Handle to MOVIE widget.

#### Return value

- = -1 On error.
- ≠ -1 Progress bar size of the given MOVIE widget.

#### 7.2.19.4.1.4 MOVIE\_GetColor()

##### Description

Returns the requested color of the widget.

##### Prototype

```
GUI_COLOR MOVIE_GetColor(MOVIE_Handle hObj,  
                        unsigned Index);
```

##### Parameters

Parameter	Description
<a href="#">hObj</a>	Handle to MOVIE widget.
<a href="#">Index</a>	See <i>MOVIE color indexes</i> on page 1962 for a full list of permitted values.

##### Return value

= GUI\_INVALID\_COLOR      On error.  
≠ GUI\_INVALID\_COLOR      Color of the given index.



### 7.2.19.4.1.5 MOVIE\_GetDefaultColor()

#### Description

Returns the default color of the given index used for newly created MOVIE widgets.

#### Prototype

```
GUI_COLOR MOVIE_GetDefaultColor(unsigned ColorIndex);
```

#### Parameters

Parameter	Description
<code>ColorIndex</code>	See <i>MOVIE color indexes</i> on page 1962 for a full list of permitted values.

#### Return value

= GUI\_INVALID\_COLOR      On error.  
≠ GUI\_INVALID\_COLOR      Default color of the given index.

### 7.2.19.4.1.6 MOVIE\_GetDefaultPeriod()

#### Description

Returns the default period of the given index used for newly created MOVIE widgets.

#### Prototype

```
int MOVIE_GetDefaultPeriod(unsigned PeriodIndex);
```

#### Parameters

Parameter	Description
<code>PeriodIndex</code>	See <i>MOVIE period indexes</i> on page 1963 for a full list of permitted values.

#### Return value

- = -1 On error.
- ≠ -1 Default period of the given index.

### 7.2.19.4.1.7 MOVIE\_GetDefaultSizeBar()

#### Description

Returns the default vertical size of the progress bar for newly created MOVIE widgets.

#### Prototype

```
int MOVIE_GetDefaultSizeBar(void);
```

#### Return value

Default vertical size of the progress bar.

### 7.2.19.4.1.8 MOVIE\_GetDefaultSizePanel()

#### Description

Returns the default vertical size of the control panel for newly created MOVIE widgets.

#### Prototype

```
int MOVIE_GetDefaultSizePanel(void);
```

#### Return value

Default vertical size of the control panel.

### 7.2.19.4.1.9 MOVIE\_GetDefaultSpace()

#### Description

Returns the default horizontal space between the buttons in the control panel for newly created MOVIE widgets.

#### Prototype

```
int MOVIE_GetDefaultSpace(void);
```

#### Return value

Default horizontal space between the buttons in the control panel.

### 7.2.19.4.1.10 MOVIE\_GethMovie()

#### Description

Returns the movie handle associated with the given MOVIE widget. The handle can be used for calling general movie functions prefixed with GUI\_MOVIE....

#### Prototype

```
GUI_MOVIE_HANDLE MOVIE_GethMovie(MOVIE_Handle hObj);
```

#### Parameters

Parameter	Description
<a href="#">hObj</a>	Handle to MOVIE widget.

#### Return value

- = 0      On error.
- ≠ 0     Movie handle of the given widget.

### 7.2.19.4.1.11 MOVIE\_GetInfo()

#### Description

Fills the given GUI\_MOVIE\_INFO structure. It contains resolution in pixels, ms per frame and total number of frames.

#### Prototype

```
int MOVIE_GetInfo(MOVIE_Handle hObj,  
                 GUI_MOVIE_INFO * pInfo);
```

#### Parameters

Parameter	Description
<a href="#">hObj</a>	Handle to MOVIE widget.
<a href="#">pInfo</a>	Pointer to a GUI_MOVIE_INFO structure.

#### Return value

= 0      On success.  
≠ 0      On error.

### 7.2.19.4.1.12 MOVIE\_GetPanelSize()

#### Description

Returns the vertical panel size of the widget.

#### Prototype

```
int MOVIE_GetPanelSize(MOVIE_Handle hObj);
```

#### Parameters

Parameter	Description
<a href="#">hObj</a>	Handle to MOVIE widget.

#### Return value

- = -1     On error.
- ≠ -1     Panel size of the MOVIE widget.



### 7.2.19.4.1.13 MOVIE\_GetPeriod()

#### Description

Returns the requested period of the widget.

#### Prototype

```
int MOVIE_GetPeriod(MOVIE_Handle hObj,  
                   unsigned      Index);
```

#### Parameters

Parameter	Description
<a href="#">hObj</a>	Handle to MOVIE widget.
<a href="#">Index</a>	See <i>MOVIE period indexes</i> on page 1963 for a full list of permitted values.

#### Return value

= -1     On error.  
≠ -1     Period of given index.

#### 7.2.19.4.1.14 MOVIE\_GetSpace()

##### Description

Returns the horizontal space between the buttons in the control panel.

##### Prototype

```
int MOVIE_GetSpace(MOVIE_Handle hObj);
```

##### Parameters

Parameter	Description
<code>hObj</code>	Handle to MOVIE widget.

##### Return value

- = -1 On error.
- ≠ -1 Space between the buttons in the control panel.

### 7.2.19.4.1.15 MOVIE\_GetUserData()

#### Description

Prototype explained at the beginning of the chapter as `<WIDGET>_GetUserData()` on page 1165.

### 7.2.19.4.1.16 MOVIE\_GotoFrame()

#### Description

The movie jumps to a requested frame.

#### Prototype

```
void MOVIE_GotoFrame(MOVIE_Handle hObj,  
                    U32          Frame);
```

#### Parameters

Parameter	Description
<code>hObj</code>	Handle to MOVIE widget.
<code>Frame</code>	Zero-based frame index the movie should jump to.

### 7.2.19.4.1.17 MOVIE\_Pause()

#### Description

Pauses the movie.

#### Prototype

```
int MOVIE_Pause(MOVIE_Handle hObj);
```

#### Parameters

Parameter	Description
<a href="#">hObj</a>	Handle to MOVIE widget.

#### Return value

= -1     On error.  
≠ -1    On success.

### 7.2.19.4.1.18 MOVIE\_Play()

#### Description

Resumes/plays the movie.

#### Prototype

```
int MOVIE_Play(MOVIE_Handle hObj);
```

#### Parameters

Parameter	Description
<a href="#">hObj</a>	Handle to MOVIE widget.

#### Return value

= -1     On error.  
≠ -1     On success.

### 7.2.19.4.1.19 MOVIE\_SetBarSize()

#### Description

Sets the vertical size of the progress bar in the control panel.

#### Prototype

```
void MOVIE_SetBarSize(MOVIE_Handle hObj,  
                     int          ySizeBar);
```

#### Parameters

Parameter	Description
<code>hObj</code>	Handle to MOVIE widget.
<code>ySizeBar</code>	New vertical size of the progress bar.

### 7.2.19.4.1.20 MOVIE\_SetCenterBitmap()

#### Description

Sets a new bitmap (play button) to be displayed in the widget's center while the movie is paused.

Typically, this would be a bitmap that shows a "play" icon.

#### Prototype

```
void MOVIE_SetCenterBitmap(    MOVIE_Handle  hObj,  
                             const GUI_BITMAP * pBmPlay);
```

#### Parameters

Parameter	Description
<code>hObj</code>	Handle to MOVIE widget.
<code>pBmPlay</code>	<b>in</b> Pointer to GUI_BITMAP structure to be used as the center play bitmap.



### 7.2.19.4.1.21 MOVIE\_SetColor()

#### Description

Sets a new color of the given color index.

#### Prototype

```
void MOVIE_SetColor(MOVIE_Handle hObj,  
                   unsigned      Index,  
                   GUI_COLOR     Color);
```

#### Parameters

Parameter	Description
<a href="#">hObj</a>	Handle to MOVIE widget.
<a href="#">Index</a>	See <i>MOVIE color indexes</i> on page 1962 for a full list of permitted values.
<a href="#">Color</a>	New color to be set.

### 7.2.19.4.1.22 MOVIE\_SetColors()

#### Description

Convenience function for `MOVIE_SetColor()` that takes in all color values at once.

#### Prototype

```
void MOVIE_SetColors(MOVIE_Handle hObj,
                    GUI_COLOR   ColorCenter,
                    GUI_COLOR   ColorPanel,
                    GUI_COLOR   ColorLeft,
                    GUI_COLOR   ColorRight,
                    GUI_COLOR   ColorBk);
```

#### Parameters

Parameter	Description
<code>hObj</code>	Handle to MOVIE widget.
<code>ColorCenter</code>	New color to be used for center bitmaps (only used for alpha bitmaps). See <code>MOVIE_SetCenterBitmap()</code> .
<code>ColorPanel</code>	New color to be used for panel button bitmaps (only used for alpha bitmaps). See <code>MOVIE_SetPanelBitmaps()</code> .
<code>ColorLeft</code>	Color the left part of the progress bar is drawn.
<code>ColorRight</code>	Color the right part of the progress bar is drawn.
<code>ColorBk</code>	Background color the widget is filled with.

### 7.2.19.4.1.23 MOVIE\_SetData()

#### Description

Sets movie file data in ROM to the widget. The widget will automatically create a movie handle and display it.

To start the movie, the widget can be clicked or `MOVIE_Start()` can be called.

#### Prototype

```
void MOVIE_SetData(    MOVIE_Handle    hObj,
                    const U8          * pData,
                    U32              Size,
                    int              DoLoop,
                    GUI_MOVIE_FUNC * pfNotify);
```

#### Parameters

Parameter	Description
<code>hObj</code>	Handle to a MOVIE widget.
<code>pData</code>	<b>in</b> Pointer to movie file data in ROM.
<code>Size</code>	Number of bytes that <code>pData</code> points to.
<code>DoLoop</code>	1 if the movie should loop, 0 if not.
<code>pfNotify</code>	<b>in</b> Optional pointer to a notification callback as described under <code>GUI_MOVIE_Create()</code> .

### 7.2.19.4.1.24 MOVIE\_SetDataEx()

#### Description

Sets external movie file data to the widget. The widget will automatically create a movie handle and display it.

To start the movie, the widget can be clicked or `MOVIE_Start()` can be called.

#### Prototype

```
void MOVIE_SetDataEx(MOVIE_Handle      hObj,
                    GUI_MOVIE_GET_DATA_FUNC * pfGetData,
                    void                * pVoidImage,
                    void                * pVoidTable,
                    int                 DoLoop,
                    GUI_MOVIE_FUNC     * pfNotify);
```

#### Parameters

Parameter	Description
<code>hObj</code>	Handle to a MOVIE widget.
<code>pfGetData</code>	<b>in</b> Function pointer to a <code>GetData</code> function. For more details, please refer to the chapter <i>FileAccess</i> on page 3219.
<code>pVoidImage</code>	<b>in</b> Void pointer passed to the function pointed by <code>pfGetData</code> . This parameter should point to the movie file data. Typically this could also be a pointer to a file handle if a file system is used.
<code>pVoidTable</code>	<b>in</b> Void pointer passed to the <code>GetData()</code> function when accessing offset table. More information can be found under <code>GUI_MOVIE_SetSecondHandle()</code> .
<code>DoLoop</code>	1 if the movie should loop, 0 if not.
<code>pfNotify</code>	<b>in</b> Optional pointer to a notification callback as described under <code>GUI_MOVIE_Create()</code> .

### 7.2.19.4.1.25 MOVIE\_SetDefaultColor()

#### Description

Sets a new default color of the given index for newly created MOVIE widgets.

#### Prototype

```
void MOVIE_SetDefaultColor(unsigned ColorIndex,  
                           GUI_COLOR Color);
```

#### Parameters

Parameter	Description
<code>ColorIndex</code>	See <i>MOVIE color indexes</i> on page 1962 for a full list of permitted values.
<code>Color</code>	New default color to be set.

### 7.2.19.4.1.26 MOVIE\_SetDefaultPeriod()

#### Description

Sets a new default period of the given index for newly created MOVIE widgets.

#### Prototype

```
void MOVIE_SetDefaultPeriod(unsigned PeriodIndex,  
                           int      Period);
```

#### Parameters

Parameter	Description
<code>PeriodIndex</code>	See <i>MOVIE period indexes</i> on page 1963 for a full list of permitted values.
<code>Period</code>	New default period to be set.

### 7.2.19.4.1.27 MOVIE\_SetDefaultSizeBar()

#### Description

Sets a new default vertical size of the progress bar for newly created MOVIE widgets.

#### Prototype

```
void MOVIE_SetDefaultSizeBar(int SizeBar);
```

#### Parameters

Parameter	Description
<a href="#">SizeBar</a>	New default vertical size of the progress bar.

### 7.2.19.4.1.28 MOVIE\_SetDefaultSizePanel()

#### Description

Sets a new default size for the control panel for newly created MOVIE widgets.

#### Prototype

```
void MOVIE_SetDefaultSizePanel(int SizePanel);
```

#### Parameters

Parameter	Description
<a href="#">SizePanel</a>	New default size for the control panel to be set.



### 7.2.19.4.1.29 MOVIE\_SetDefaultSpace()

#### Description

Sets a new default horizontal space between the buttons in the control panel for newly created MOVIE widgets.

#### Prototype

```
void MOVIE_SetDefaultSpace(int Space);
```

#### Parameters

Parameter	Description
Space	New default horizontal space.

### 7.2.19.4.1.30 MOVIE\_SetPanelBitmaps()

#### Description

Sets the bitmaps displayed in the panel.

If alpha bitmaps are used, a color can be set with `MOVIE_SetColor(MOVIE_CI_PANEL)`.

#### Prototype

```
void MOVIE_SetPanelBitmaps(    MOVIE_Handle  hObj,
                             const GUI_BITMAP * pBmPlay,
                             const GUI_BITMAP * pBmPause,
                             const GUI_BITMAP * pBmStart);
```

#### Parameters

Parameter	Description
<code>hObj</code>	Handle to MOVIE widget.
<code>pBmPlay</code>	<b>in</b> Bitmap used for the play button in the panel.
<code>pBmPause</code>	<b>in</b> Bitmap used for the pause button in the panel.
<code>pBmStart</code>	<b>in</b> Bitmap used for the start button in the panel. Optional, can be <code>NULL</code> .

#### Additional information

The play and pause bitmaps are **both** required, otherwise the panel will not be shown. The start bitmap is optional.

### 7.2.19.4.1.31 MOVIE\_SetPeriod()

#### Description

Sets a period of the given index.

#### Prototype

```
void MOVIE_SetPeriod(MOVIE_Handle hObj,  
                    unsigned      PeriodIndex,  
                    int           Period);
```

#### Parameters

Parameter	Description
<a href="#">hObj</a>	Handle to MOVIE widget.
<a href="#">PeriodIndex</a>	See <i>MOVIE period indexes</i> on page 1963 for a full list of permitted values.
<a href="#">Period</a>	New period to be used.

### 7.2.19.4.1.32 MOVIE\_SetPeriods()

#### Description

Convenience function for `MOVIE_SetPeriod()` to set all periods at once.

#### Prototype

```
void MOVIE_SetPeriods(MOVIE_Handle hObj,  
                    int           PeriodShiftIn,  
                    int           PeriodShiftOut,  
                    int           PeriodInactive);
```

#### Parameters

Parameter	Description
<code>hObj</code>	Handle to MOVIE widget.
<code>PeriodShiftIn</code>	Animation period in ms for shifting in the control panel.
<code>PeriodShiftOut</code>	Animation period in ms for shifting out the control panel.
<code>PeriodInactive</code>	Timer period in ms it takes for the shifting out animation of the control panel to trigger.

### 7.2.19.4.1.33 MOVIE\_SetPanelSize()

#### Description

Sets the vertical size of the control panel.

#### Prototype

```
void MOVIE_SetPanelSize(MOVIE_Handle hObj,  
                        int          ySizePanel);
```

#### Parameters

Parameter	Description
<code>hObj</code>	Handle to MOVIE widget.
<code>ySizePanel</code>	New vertical size of the widget's control panel.

### 7.2.19.4.1.34 MOVIE\_SetSizes()

#### Description

Convenience function that sets all panel sizes at once.

#### Prototype

```
void MOVIE_SetSizes(MOVIE_Handle hObj,  
                   int           ySizePanel,  
                   int           ySizeBar,  
                   int           Space);
```

#### Parameters

Parameter	Description
<a href="#">hObj</a>	Handle to MOVIE widget.
<a href="#">ySizePanel</a>	New vertical size of the widget's control panel.
<a href="#">ySizeBar</a>	New vertical size of the progress bar.
<a href="#">Space</a>	New horizontal spacing value for the buttons.

### 7.2.19.4.1.35 MOVIE\_SetSpace()

#### Description

Sets the horizontal spacing between the buttons in the control panel.

#### Prototype

```
void MOVIE_SetSpace(MOVIE_Handle hObj,  
                   int          Space);
```

#### Parameters

Parameter	Description
<a href="#">hObj</a>	Handle to MOVIE widget.
<a href="#">Space</a>	New horizontal spacing value for the buttons.

### 7.2.19.4.1.36 MOVIE\_SetUserData()

#### Description

Prototype explained at the beginning of the chapter as `<WIDGET>_SetUserData()` on page 1166.



## 7.2.19.4.2 Defines

### 7.2.19.4.2.1 MOVIE bitmap indexes

#### Description

Bitmap indexes for MOVIE widget.

#### Definition

```
#define MOVIE_BI_CENTER_PLAY 0
#define MOVIE_BI_PANEL_PLAY 1
#define MOVIE_BI_PANEL_PAUSE 2
#define MOVIE_BI_PANEL_BEGIN 3
```

#### Symbols

Definition	Description
<a href="#">MOVIE_BI_CENTER_PLAY</a>	Bitmap to be shown as play button in the center of the widget.
<a href="#">MOVIE_BI_PANEL_PLAY</a>	Bitmap for panel play button.
<a href="#">MOVIE_BI_PANEL_PAUSE</a>	Bitmap for panel pause button.
<a href="#">MOVIE_BI_PANEL_BEGIN</a>	Bitmap for panel begin button.

### 7.2.19.4.2.2 MOVIE color indexes

#### Description

Color indexes for MOVIE widget.

#### Definition

```
#define MOVIE_CI_CENTER      0
#define MOVIE_CI_PANEL      1
#define MOVIE_CI_BK         2
#define MOVIE_CI_LEFT       3
#define MOVIE_CI_RIGHT      4
```

#### Symbols

Definition	Description
<a href="#">MOVIE_CI_CENTER</a>	Color for center bitmap.
<a href="#">MOVIE_CI_PANEL</a>	Color for panel bitmaps.
<a href="#">MOVIE_CI_BK</a>	Color for background if MOVIE does not fill the complete widget area.
<a href="#">MOVIE_CI_LEFT</a>	Color for progress bar (left).
<a href="#">MOVIE_CI_RIGHT</a>	Color for progress bar (right).

### 7.2.19.4.2.3 MOVIE period indexes

#### Description

Period indexes for MOVIE widgets.

#### Definition

```
#define MOVIE_PI_SHIFT_IN      0
#define MOVIE_PI_SHIFT_OUT    1
#define MOVIE_PI_INACTIVE     2
```

#### Symbols

Definition	Description
<a href="#">MOVIE_PI_SHIFT_IN</a>	The length in ms for shifting in the panel.
<a href="#">MOVIE_PI_SHIFT_OUT</a>	The length in ms for shifting out the panel.
<a href="#">MOVIE_PI_INACTIVE</a>	Period it takes from releasing the widget until the shifting operation is started.



## 7.2.20 MULTIEDIT: Multi line text widget

The MULTIEDIT widget enables you to edit text with multiple lines. You can use it as a simple text editor or to display static text. The widget supports scrolling with and without scroll bars.

### Note

All MULTIEDIT-related routines are in the file(s) MULTIEDIT\*.c, MULTIEDIT.h. All identifiers are prefixed MULTIEDIT.

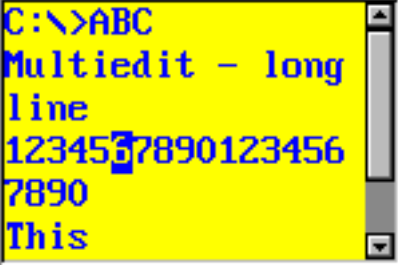
The table below shows the appearance of the MULTIEDIT widget:

Description	Frame window
Edit mode, automatic horizontal scroll bar, non wrapping mode, insert mode	
Edit mode, automatic vertical scroll bar, word wrapping mode, overwrite mode	
Read only mode, word wrapping mode	

### 7.2.20.1 Configuration options

Type	Macro	Default	Description
S	MULTIEDIT_FONT_DEFAULT	GUI_Font13_1	Font used.
N	MULTIEDIT_BKCOLOR0_DEFAULT	GUI_WHITE	Background color.
N	MULTIEDIT_BKCOLOR1_DEFAULT	0xC0C0C0	Background color read only mode.
N	MULTIEDIT_TEXTCOLOR0_DEFAULT	GUI_BLACK	Text color.
N	MULTIEDIT_TEXTCOLOR1_DEFAULT	GUI_BLACK	Text color read only mode.
N	MULTIEDIT_CURSORCOLORBK_DEFAULT	GUI_BLACK	Background cursor color.
N	MULTIEDIT_CURSORCOLORFG_DEFAULT	GUI_WHITE	Foreground cursor color.

Type	Macro	Default	Description
N	MULTIEDIT_ALIGN_DEFAULT	GUI_TA_LEFT   GUI_TA_V- CENTER	Foreground cursor color.
N	MULTIEDIT_HBORDER_DEFAULT	1	Horizontal border between widget edge and text.

### 7.2.20.2 Predefined IDs

The following symbols define IDs which may be used to make MULTIEDIT widgets distinguishable from creation.

```
#define GUI_ID_MULTIEDIT0    0x190
#define GUI_ID_MULTIEDIT1    0x191
#define GUI_ID_MULTIEDIT2    0x192
#define GUI_ID_MULTIEDIT3    0x193
#define GUI_ID_MULTIEDIT4    0x194
#define GUI_ID_MULTIEDIT5    0x195
#define GUI_ID_MULTIEDIT6    0x196
#define GUI_ID_MULTIEDIT7    0x197
#define GUI_ID_MULTIEDIT8    0x198
#define GUI_ID_MULTIEDIT9    0x199
```

### 7.2.20.3 Notification codes

The following events are sent from the widget to its parent window as part of a WM\_NOTIFY\_PARENT message:

Message	Description
WM_NOTIFICATION_CLICKED	Widget has been clicked.
WM_NOTIFICATION_RELEASED	Widget has been released.
WM_NOTIFICATION_MOVED_OUT	Widget has been clicked and pointer has been moved out of the widget without releasing.
WM_NOTIFICATION_SCROLL_CHANGED	The scroll position of the optional scroll bar has been changed.
WM_NOTIFICATION_VALUE_CHANGED	The text of the widget has been changed.

### 7.2.20.4 Keyboard reaction

The widget reacts to the following keys if it has the input focus:

Key	Reaction
GUI_KEY_UP	Moves the cursor one line up.
GUI_KEY_DOWN	Moves the cursor one line down.
GUI_KEY_RIGHT	Moves the cursor one character to the right.
GUI_KEY_LEFT	Moves the cursor one character to the left.
GUI_KEY_END	Moves the cursor to the end of the current row.
GUI_KEY_HOME	Moves the cursor to the begin of the current row.
GUI_KEY_BACKSPACE	If the widget works in read/write mode this key deletes the character before the cursor.
GUI_KEY_DELETE	If the widget works in read/write mode this key deletes the character below the cursor.
GUI_KEY_INSERT	Toggles between insert and overwrite mode.
GUI_KEY_ENTER	If the widget works in read/write mode this key inserts a new line (\n) at the current position. If the widget works in read only mode the cursor will be moved to the beginning of the next line.
GUI_KEY_PGUP	Scrolls the MULTIEDIT page wise up.
GUI_KEY_PGDOWN	Scrolls the MULTIEDIT page wise down.

## 7.2.20.5 MULTIEDIT API

The table below lists the available emWin MULTIEDIT-related routines in alphabetical order. Detailed descriptions of the routines follow.

### Functions

Routine	Description
<code>MULTIEDIT_AddKey()</code>	Adds user input to a specified MULTIEDIT widget.
<code>MULTIEDIT_AddText()</code>	Adds the given text at the current cursor position.
<code>MULTIEDIT_Create()</code>	Creates a MULTIEDIT widget. (Obsolete)
<code>MULTIEDIT_CreateEx()</code>	Creates a MULTIEDIT widget.
<code>MULTIEDIT_CreateIndirect()</code>	Creates a MULTIEDIT widget from a resource table entry.
<code>MULTIEDIT_CreateUser()</code>	Creates a MULTIEDIT widget using extra bytes as user data.
<code>MULTIEDIT_EnableBlink()</code>	Enables/disables a blinking cursor.
<code>MULTIEDIT_EnableMotion()</code>	Enables motion scrolling for the MULTIEDIT widget.
<code>MULTIEDIT_GetBkColor()</code>	Returns the background color of the widget.
<code>MULTIEDIT_GetCursorCharPos()</code>	Returns the number of the character at the cursor position.
<code>MULTIEDIT_GetCursorPixelPos()</code>	Returns the pixel position of the cursor in window coordinates.
<code>MULTIEDIT_GetDefaultAlign()</code>	Returns the default text alignment of new MULTIEDIT widgets.
<code>MULTIEDIT_GetDefaultBkColor()</code>	Returns the default background color for new MULTIEDIT widgets.
<code>MULTIEDIT_GetDefaultCursorColor()</code>	Returns the default foreground or background cursor color for new MULTIEDIT widgets.
<code>MULTIEDIT_GetDefaultFont()</code>	Returns the default font for new MULTIEDIT widgets.
<code>MULTIEDIT_GetDefaultHBorder()</code>	Returns the default horizontal border for new MULTIEDIT widgets.
<code>MULTIEDIT_GetDefaultTextColor()</code>	Returns the default text color for new MULTIEDIT widgets.
<code>MULTIEDIT_GetFont()</code>	Returns the font of the widget.
<code>MULTIEDIT_GetNumChars()</code>	Returns the number of characters of the MULTIEDIT widget.
<code>MULTIEDIT_GetPrompt()</code>	Returns the current prompt text.
<code>MULTIEDIT_GetText()</code>	Returns the current text.
<code>MULTIEDIT_GetTextColor()</code>	Returns the text color of the widget.
<code>MULTIEDIT_GetTextSize()</code>	Returns the buffer size used to store the current text (and prompt).
<code>MULTIEDIT_GetUserData()</code>	Retrieves the data set with <code>MULTIEDIT_SetUserData()</code> .
<code>MULTIEDIT_SetAutoScrollH()</code>	Enables/disables the automatic use of a horizontal scroll bar.
<code>MULTIEDIT_SetAutoScrollV()</code>	Enables/disables the automatic use of a vertical scroll bar.

Routine	Description
<code>MULTIEDIT_SetBkColor()</code>	Sets the background color of the given MULTIEDIT widget.
<code>MULTIEDIT_SetBufferSize()</code>	Sets the maximum number of bytes used by text and prompt.
<code>MULTIEDIT_SetCursorCharPos()</code>	This function sets the cursor to the given position where x is the character in a line and y is line.
<code>MULTIEDIT_SetCursorColor()</code>	Sets the background or foreground cursor color of the given MULTIEDIT widget.
<code>MULTIEDIT_SetCursorOffset()</code>	Sets the cursor position to the given character.
<code>MULTIEDIT_SetCursorPixelPos()</code>	This function sets the cursor to the given position, where x and y are the coordinates in pixels relative to the widget.
<code>MULTIEDIT_SetDefaultAlign()</code>	Sets the default text alignment for new MULTIEDIT widgets.
<code>MULTIEDIT_SetDefaultBkColor()</code>	Sets the default background color for new MULTIEDIT widgets.
<code>MULTIEDIT_SetDefaultCursorColor()</code>	Sets the default cursor color for new MULTIEDIT widgets.
<code>MULTIEDIT_SetDefaultFont()</code>	Sets the default font for new MULTIEDIT widgets.
<code>MULTIEDIT_SetDefaultHBorder()</code>	Sets the default horizontal border for new MULTIEDIT widgets.
<code>MULTIEDIT_SetDefaultTextColor()</code>	Sets the default text color for new MULTIEDIT widgets.
<code>MULTIEDIT_SetFocusable()</code>	Sets the focusability of the given MULTIEDIT widget.
<code>MULTIEDIT_SetFont()</code>	Sets the font.
<code>MULTIEDIT_SetHBorder()</code>	Sets the size of the horizontal border.
<code>MULTIEDIT_SetInsertMode()</code>	Enables/disables the insert mode.
<code>MULTIEDIT_SetInvertCursor()</code>	Enables/disables the inversion mode of cursor.
<code>MULTIEDIT_SetMaxNumChars()</code>	Sets the maximum number of characters used by text and prompt.
<code>MULTIEDIT_SetPasswordMode()</code>	Enables/disables the password mode.
<code>MULTIEDIT_SetPrompt()</code>	Sets the prompt text.
<code>MULTIEDIT_SetReadOnly()</code>	Enables/disables the read only mode.
<code>MULTIEDIT_SetText()</code>	Sets the text.
<code>MULTIEDIT_SetTextAlign()</code>	Sets the text alignment.
<code>MULTIEDIT_SetTextColor()</code>	Sets the text color.
<code>MULTIEDIT_SetUserData()</code>	Sets the extra data of a MULTIEDIT widget.
<code>MULTIEDIT_SetWrapChar()</code>	Enables the char wrapping mode.
<code>MULTIEDIT_SetWrapNone()</code>	Enables the non wrapping mode.
<code>MULTIEDIT_SetWrapWord()</code>	Enables the word wrapping mode.
<code>MULTIEDIT_ShowCursor()</code>	This function enables or disables the cursor of the MULTIEDIT widget.

## Defines

Group of defines	Description
<code>MULTIEDIT_color_indexes</code>	Color indexes used by the MULTIEDIT widget.



Group of defines	Description
<code>MULTIEDIT cursor color indexes</code>	Cursor color indexes used by the MULTIEDIT widget.
<code>MULTIEDIT create flags</code>	Create flags used by <code>MULTIEDIT_CreateEx()</code> .

## 7.2.20.5.1 Functions

### 7.2.20.5.1.1 MULTIEDIT\_AddKey()

#### Description

Adds user input to a specified MULTIEDIT widget.

#### Prototype

```
int MULTIEDIT_AddKey(MULTIEDIT_HANDLE hObj,  
                    U16 Key);
```

#### Parameters

Parameter	Description
<a href="#">hObj</a>	Handle of MULTIEDIT widget.
<a href="#">Key</a>	Character to be added.

#### Return value

1 if [Key](#) has been consumed.  
0 if [Key](#) was not handled.

#### Additional information

The specified character is added to the user input of the MULTIEDIT widget. If the maximum count of characters has been reached, another character will not be added.

### 7.2.20.5.1.2 MULTIEDIT\_AddText()

#### Description

Adds the given text at the current cursor position.

#### Prototype

```
int MULTIEDIT_AddText(      MULTIEDIT_HANDLE  hObj,  
                          const char        * s);
```

#### Parameters

Parameter	Description
<code>hObj</code>	Handle of MULTIEDIT widget.
<code>s</code>	Pointer to a NULL terminated text to be added.

#### Additional information

If the number of characters exceeds the limit set with the function `MULTIEDIT_SetMaxNumChars()` the function will add only the characters of the text which fit into the widget respecting the limit.

If the the function `MULTIEDIT_SetMaxNumChars()` has not been called the `MULTIEDIT` widget increases its buffer automatically to hold the complete text.

### 7.2.20.5.1.3 MULTIEDIT\_Create()

#### Note

This function is **deprecated**, `MULTIEDIT_CreateEx()` should be used instead.

#### Description

Creates a `MULTIEDIT` widget of a specified size at a specified location.

#### Prototype

```
MULTIEDIT_HANDLE MULTIEDIT_Create(
    int         x0,
    int         y0,
    int         xSize,
    int         ySize,
    WM_HWIN    hParent,
    int         Id,
    int         Flags,
    int         ExFlags,
    const char * pText,
    int         MaxLen);
```

#### Parameters

Parameter	Description
<code>x0</code>	Leftmost pixel of the <code>MULTIEDIT</code> widget (in parent coordinates).
<code>y0</code>	Topmost pixel of the <code>MULTIEDIT</code> widget (in parent coordinates).
<code>xSize</code>	Horizontal size of the <code>MULTIEDIT</code> widget (in pixels).
<code>ySize</code>	Vertical size of the <code>MULTIEDIT</code> widget (in pixels).
<code>hParent</code>	Parent window of the <code>MULTIEDIT</code> widget.
<code>Id</code>	ID of the <code>MULTIEDIT</code> widget.
<code>Flags</code>	Window create flags. Typically <code>WM_CF_SHOW</code> in order to make the widget visible immediately (refer to <i>Window create flags</i> on page 1146 in the chapter <i>The Window Manager (WM)</i> on page 960 for a list of available parameter values).
<code>ExFlags</code>	See <i>MULTIEDIT create flags</i> on page 2027.
<code>pText</code>	Text to be used.
<code>MaxLen</code>	Maximum number of bytes for text and prompt.
<code>s</code>	Pointer to a <code>NULL</code> terminated text to be added.

#### Return value

Handle of the created `MULTIEDIT` widget; 0 if the function fails.

### 7.2.20.5.1.4 MULTIEDIT\_CreateEx()

#### Description

Creates a MULTIEDIT widget of a specified size at a specified location.

#### Prototype

```
MULTIEDIT_HANDLE MULTIEDIT_CreateEx(    int        x0,
                                        int        y0,
                                        int        xSize,
                                        int        ySize,
                                        WM_HWIN    hParent,
                                        int        WinFlags,
                                        int        ExFlags,
                                        int        Id,
                                        int        BufferSize,
                                        const char * pText);
```

#### Parameters

Parameter	Description
<code>x0</code>	Leftmost pixel of the widget (in parent coordinates).
<code>y0</code>	Topmost pixel of the widget (in parent coordinates).
<code>xSize</code>	Horizontal size of the widget (in pixels).
<code>ySize</code>	Vertical size of the widget (in pixels).
<code>hParent</code>	Handle of parent window. If 0, the new MULTIEDIT widget will be a child of the desktop (top-level window).
<code>WinFlags</code>	Window create flags. Typically <code>WM_CF_SHOW</code> in order to make the widget visible immediately (refer to <i>Window create flags</i> on page 1146 for a list of available parameter values).
<code>ExFlags</code>	See <i>MULTIEDIT create flags</i> on page 2027.
<code>Id</code>	Window ID of the widget.
<code>BufferSize</code>	Initial text buffer size of the widget. Use <code>MULTIEDIT_SetMaxNumChars()</code> to set the maximum number of characters.
<code>pText</code>	Text to be used.

#### Return value

Handle of the created MULTIEDIT widget; 0 if the function fails.

#### Additional information

If the text set for the MULTIEDIT widget exceeds the number of bytes allocated at creation (`BufferSize`) the widget increases the buffer automatically. To avoid this the user can call `MULTIEDIT_SetMaxNumChars()`.

### 7.2.20.5.1.5 MULTIEDIT\_CreateIndirect()

#### Description

The prototype of this function is explained at the beginning of this chapter. Details can be found in the description of the function `<WIDGET>_CreateIndirect()` on page 1161. The element `Para` of the according `GUI_WIDGET_CREATE_INFO` structure is used according to the parameter `BufferSize` of the function `MULTIEDIT_CreateEx()`. The element `Flags` is used according to the parameter `ExFlags` of the function `MULTIEDIT_CreateEx()`.

### 7.2.20.5.1.6 MULTIEDIT\_CreateUser()

#### Description

Prototype explained at the beginning of the chapter as `<WIDGET>_CreateUser()` on page 1162. For a detailed description of the parameters the function `MULTIEDIT_CreateEx()` can be referred to.

### 7.2.20.5.1.7 MULTIEDIT\_EnableBlink()

#### Description

Enables/disables a blinking cursor.

#### Prototype

```
void MULTIEDIT_EnableBlink(MULTIEDIT_HANDLE hObj,  
                           int             Period,  
                           int             OnOff);
```

#### Parameters

Parameter	Description
<code>hObj</code>	Handle of MULTIEDIT widget.
<code>Period</code>	Blinking period
<code>OnOff</code>	1 enables blinking, 0 disables blinking

#### Additional information

This function calls `GUI_X_GetTime()`.



### 7.2.20.5.1.8 MULTIEDIT\_EnableMotion()

#### Description

Enables motion scrolling for the MULTIEDIT widget.

#### Prototype

```
void MULTIEDIT_EnableMotion(MULTIEDIT_HANDLE hObj,
                             int Flags);
```

#### Parameters

Parameter	Description
<a href="#">hObj</a>	Handle of MULTIEDIT widget.
<a href="#">Flags</a>	See table below.

Permitted values for parameter <a href="#">Flags</a>	
0	Disables motion support.
MULTIEDIT_CF_MOTION_H	Enables horizontal motion support.
MULTIEDIT_CF_MOTION_V	Enables vertical motion support.

#### Additional information

If motion support isn't enabled for the window manager, it will be activated automatically.

Note that motion support cannot be used in conjunction with scrollbars. This means that enabling motion support on one axis will remove a scrollbar attached to the same axis and vice versa.

### 7.2.20.5.1.9 MULTIEDIT\_GetBkColor()

#### Description

Returns the background color of the widget.

#### Prototype

```
GUI_COLOR MULTIEDIT_GetBkColor(MULTIEDIT_HANDLE hObj,  
                                unsigned Index);
```

#### Parameters

Parameter	Description
<a href="#">hObj</a>	Handle of MULTIEDIT widget.
<a href="#">Index</a>	See <i>MULTIEDIT color indexes</i> on page 2025 for a full list of permitted values.

#### Additional information

This function calls `GUI_X_GetTime()`.

### 7.2.20.5.1.10 MULTIEDIT\_GetCursorCharPos()

#### Description

Returns the number of the character at the cursor position.

#### Prototype

```
int MULTIEDIT_GetCursorCharPos(MULTIEDIT_HANDLE hObj);
```

#### Parameters

Parameter	Description
<a href="#">hObj</a>	Handle of MULTIEDIT widget.

#### Return value

Number of the character at the cursor position.

#### Additional information

The widget returns the character position if it has the focus or not. This means the cursor position is also returned, if the cursor is currently not visible in the widget.

### 7.2.20.5.1.11 MULTIEDIT\_GetCursorPixelPos()

#### Description

Returns the pixel position of the cursor in window coordinates.

#### Prototype

```
void MULTIEDIT_GetCursorPixelPos(MULTIEDIT_HANDLE hObj,  
                                int * pxPos,  
                                int * pyPos);
```

#### Parameters

Parameter	Description
<code>hObj</code>	Handle of MULTIEDIT widget.
<code>pxPos</code>	Pointer to integer variable for the X-position in window coordinates.
<code>pyPos</code>	Pointer to integer variable for the Y-position in window coordinates.

#### Additional information

The widget returns the pixel position if it has the focus or not. This means the cursor position is also returned, if the cursor is currently not visible in the widget.

### 7.2.20.5.1.12 MULTIEDIT\_GetDefaultAlign()

#### Description

Returns the default text alignment of new MULTIEDIT widgets.

#### Prototype

```
int MULTIEDIT_GetDefaultAlign(void);
```

#### Return value

Default text alignment of new MULTIEDIT widgets.

### 7.2.20.5.1.13 MULTIEDIT\_GetDefaultBkColor()

#### Description

Returns the default background color for new MULTIEDIT widgets.

#### Prototype

```
GUI_COLOR MULTIEDIT_GetDefaultBkColor(unsigned Index);
```

#### Parameters

Parameter	Description
<a href="#">Index</a>	See <i>MULTIEDIT color indexes</i> on page 2025 for a full list of permitted values.

#### Return value

Default background color for new MULTIEDIT widgets.

### 7.2.20.5.1.14 MULTIEDIT\_GetDefaultCursorColor()

#### Description

Returns the default foreground or background cursor color for new MULTIEDIT widgets.

#### Prototype

```
GUI_COLOR MULTIEDIT_GetDefaultCursorColor(unsigned Index);
```

#### Parameters

Parameter	Description
<a href="#">Index</a>	See <i>MULTIEDIT cursor color indexes</i> on page 2026 for a full list of permitted values.

#### Return value

Default foreground or background cursor color for new MULTIEDIT widgets.

### 7.2.20.5.1.15 MULTIEDIT\_GetDefaultFont()

#### Description

Returns the default font for new MULTIEDIT widgets.

#### Prototype

```
GUI_FONT *MULTIEDIT_GetDefaultFont(void);
```

#### Return value

Default font for new MULTIEDIT widgets.



### 7.2.20.5.1.16 MULTIEDIT\_GetDefaultHBorder()

#### Description

Returns the default horizontal border for new MULTIEDIT widgets.

#### Prototype

```
unsigned MULTIEDIT_GetDefaultHBorder(void);
```

#### Return value

Default horizontal border for new MULTIEDIT widgets.

### 7.2.20.5.1.17 MULTIEDIT\_GetDefaultTextColor()

#### Description

Returns the default text color for new MULTIEDIT widgets.

#### Prototype

```
GUI_COLOR MULTIEDIT_GetDefaultTextColor(unsigned Index);
```

#### Parameters

Parameter	Description
<a href="#">Index</a>	See <i>MULTIEDIT color indexes</i> on page 2025 for a full list of permitted values.

#### Return value

Default text color for new MULTIEDIT widgets.

### 7.2.20.5.1.18 MULTIEDIT\_GetFont()

#### Description

Returns the font of the widget.

#### Prototype

```
GUI_FONT *MULTIEDIT_GetFont(MULTIEDIT_HANDLE hObj);
```

#### Parameters

Parameter	Description
<a href="#">hObj</a>	Handle of MULTIEDIT widget.

#### Return value

Pointer to the font of the given widget.

### 7.2.20.5.1.19 MULTIEDIT\_GetNumChars()

#### Description

Returns the number of characters of the MULTIEDIT widget.

#### Prototype

```
int MULTIEDIT_GetNumChars(MULTIEDIT_HANDLE hObj);
```

#### Parameters

Parameter	Description
<code>hObj</code>	Handle of MULTIEDIT widget.

#### Return value

Number of characters present in the specified MULTIEDIT widget.

### 7.2.20.5.1.20 MULTIEDIT\_GetPrompt()

#### Description

Returns the current prompt text.

#### Prototype

```
void MULTIEDIT_GetPrompt (MULTIEDIT_HANDLE hObj,  
                          char * sDest,  
                          int MaxLen);
```

#### Parameters

Parameter	Description
<a href="#">hObj</a>	Handle of MULTIEDIT widget.
<a href="#">sDest</a>	Buffer for the prompt text to be returned.
<a href="#">MaxLen</a>	Maximum number of bytes to be copied to <a href="#">sDest</a> .

#### Additional information

The function copies the current prompt text to the buffer given by [sDest](#). The maximum number of bytes copied to the buffer is given by [MaxLen](#).

### 7.2.20.5.1.21 MULTIEDIT\_GetText()

#### Description

Returns the current text.

#### Prototype

```
void MULTIEDIT_GetText (MULTIEDIT_HANDLE hObj,  
                        char * sDest,  
                        int MaxLen);
```

#### Parameters

Parameter	Description
<a href="#">hObj</a>	Handle of MULTIEDIT widget.
<a href="#">sDest</a>	Buffer for the text to be returned.
<a href="#">MaxLen</a>	Maximum number of bytes to be copied to <a href="#">sDest</a> .

#### Additional information

The function copies the current text to the buffer given by [sDest](#). The maximum number of bytes copied to the buffer is given by [MaxLen](#).

### 7.2.20.5.1.22 MULTIEDIT\_GetTextColor()

#### Description

Returns the text color of the widget.

#### Prototype

```
GUI_COLOR MULTIEDIT_GetTextColor(MULTIEDIT_HANDLE hObj,  
                                unsigned          Index);
```

#### Parameters

Parameter	Description
<a href="#">hObj</a>	Handle of MULTIEDIT widget.
<a href="#">Index</a>	See <i>MULTIEDIT color indexes</i> on page 2025 for a full list of permitted values.

#### Return value

The text color of the given widget.

### 7.2.20.5.1.23 MULTIEDIT\_GetTextSize()

#### Description

Returns the buffer size used to store the current text (and prompt).

#### Prototype

```
int MULTIEDIT_GetTextSize(MULTIEDIT_HANDLE hObj);
```

#### Parameters

Parameter	Description
<a href="#">hObj</a>	Handle of MULTIEDIT widget.

#### Return value

Buffer size used to store the current text (and prompt).



#### 7.2.20.5.1.24 MULTIEDIT\_GetUserData()

##### **Description**

Prototype explained at the beginning of the chapter as `<WIDGET>_GetUserData()` on page 1165.

### 7.2.20.5.1.25 MULTIEDIT\_SetAutoScrollH()

#### Description

Enables/disables the automatic use of a horizontal scroll bar.

#### Prototype

```
void MULTIEDIT_SetAutoScrollH(MULTIEDIT_HANDLE hObj,  
                               int OnOff);
```

#### Parameters

Parameter	Description
<code>hObj</code>	Handle of MULTIEDIT widget.
<code>OnOff</code>	1 for enabling automatic use of a horizontal scroll bar, 0 for disabling.

#### Additional information

Enabling the use of a automatic horizontal scroll bar only makes sense with the non wrapping mode explained later in this chapter. If enabled the MULTIEDIT widget checks if the width of the non wrapped text fits into the client area. If not a horizontal scroll bar will be attached to the window.

Note that enabling scrollbars will disable motion support for the widget.

### 7.2.20.5.1.26 MULTIEDIT\_SetAutoScrollV()

#### Description

Enables/disables the automatic use of a vertical scroll bar.

#### Prototype

```
void MULTIEDIT_SetAutoScrollV(MULTIEDIT_HANDLE hObj,  
                               int OnOff);
```

#### Parameters

Parameter	Description
<code>hObj</code>	Handle of MULTIEDIT widget.
<code>OnOff</code>	1 for enabling automatic use of a vertical scroll bar, 0 for disabling.

#### Additional information

If enabled the MULTIEDIT widget checks if the height of the text fits into the client area. If not a vertical scroll bar will be attached to the window.

Note that enabling scrollbars will disable motion support for the widget.

### 7.2.20.5.1.27 MULTIEDIT\_SetBkColor()

#### Description

Sets the background color of the given MULTIEDIT widget.

#### Prototype

```
void MULTIEDIT_SetBkColor(MULTIEDIT_HANDLE hObj,  
                          unsigned Index,  
                          GUI_COLOR color);
```

#### Parameters

Parameter	Description
<a href="#">hObj</a>	Handle of MULTIEDIT widget.
<a href="#">Index</a>	See <i>MULTIEDIT color indexes</i> on page 2025 for a full list of permitted values.
<a href="#">Color</a>	Background color to be used.

### 7.2.20.5.1.28 MULTIEDIT\_SetBufferSize()

#### Description

Sets the maximum number of bytes used by text and prompt.

#### Prototype

```
void MULTIEDIT_SetBufferSize(MULTIEDIT_HANDLE hObj,  
                             int BufferSize);
```

#### Parameters

Parameter	Description
<code>hObj</code>	Handle of MULTIEDIT widget.
<code>BufferSize</code>	Maximum number of bytes.

#### Additional information

The function clears the current content of the MULTIEDIT widget and allocates the given number of bytes for the text and for the prompt.

### 7.2.20.5.1.29 MULTIEDIT\_SetCursorCharPos()

#### Description

This function sets the cursor to the given position where **x** is the character in a line and **y** is line. 0, 0 is the very first character. 0, 1 would be the the first character of the second line and so on.

#### Prototype

```
void MULTIEDIT_SetCursorCharPos(MULTIEDIT_HANDLE hObj,  
                                int x,  
                                int y);
```

#### Parameters

Parameter	Description
<b>hObj</b>	Handle of MULTIEDIT widget.
<b>x</b>	X - Character position of the line.
<b>y</b>	Y - Index of line.

### 7.2.20.5.1.30 MULTIEDIT\_SetCursorColor()

#### Description

Sets the background or foreground cursor color of the given MULTIEDIT widget.

#### Prototype

```
void MULTIEDIT_SetCursorColor(MULTIEDIT_HANDLE hObj,  
                             unsigned Index,  
                             GUI_COLOR color);
```

#### Parameters

Parameter	Description
<a href="#">hObj</a>	Handle of MULTIEDIT widget.
<a href="#">Index</a>	See <i>MULTIEDIT color indexes</i> on page 2025 for a full list of permitted values.
<a href="#">Color</a>	<a href="#">Color</a> to be used.

#### Additional information

These colors are taken into account only if the inversion mode of the cursor is disabled.

### 7.2.20.5.1.31 MULTIEDIT\_SetCursorOffset()

#### Description

Sets the cursor position to the given character.

#### Prototype

```
void MULTIEDIT_SetCursorOffset(MULTIEDIT_HANDLE hObj,  
                               int Offset);
```

#### Parameters

Parameter	Description
<code>hObj</code>	Handle of MULTIEDIT widget.
<code>Offset</code>	New cursor position.

#### Additional information

The number of characters used for the prompt has to be added to the parameter `Offset`. If a prompt is used the value for parameter `Offset` should not be smaller than the number of characters used for the prompt.



### 7.2.20.5.1.32 MULTIEDIT\_SetCursorPixelPos()

#### Description

This function sets the cursor to the given position, where x and y are the coordinates in pixels relative to the widget.

#### Prototype

```
void MULTIEDIT_SetCursorPixelPos(MULTIEDIT_HANDLE hObj,  
                                int x,  
                                int y);
```

#### Parameters

Parameter	Description
<code>hObj</code>	Handle of MULTIEDIT widget.
<code>xPos</code>	X position in pixels.
<code>yPos</code>	Y position in pixels.

### 7.2.20.5.1.33 MULTIEDIT\_SetDefaultAlign()

#### Description

Sets the default text alignment for new MULTIEDIT widgets.

#### Prototype

```
void MULTIEDIT_SetDefaultAlign(int Align);
```

#### Parameters

Parameter	Description
<a href="#">Align</a>	See <i>Text alignment flags</i> on page 286. <b>Only horizontal left and right alignment flags are applicable!</b>

### 7.2.20.5.1.34 MULTIEDIT\_SetDefaultBkColor()

#### Description

Sets the default background color for new MULTIEDIT widgets.

#### Prototype

```
void MULTIEDIT_SetDefaultBkColor(GUI_COLOR Color,  
                                unsigned Index);
```

#### Parameters

Parameter	Description
Color	Color to be used.
Index	See <i>MULTIEDIT color indexes</i> on page 2025 for a full list of permitted values.

### 7.2.20.5.1.35 MULTIEDIT\_SetDefaultCursorColor()

#### Description

Sets the default cursor color for new MULTIEDIT widgets.

#### Prototype

```
void MULTIEDIT_SetDefaultCursorColor(GUI_COLOR Color,  
                                     unsigned Index);
```

#### Parameters

Parameter	Description
Color	Color to be used.
Index	See <i>MULTIEDIT color indexes</i> on page 2025 for a full list of permitted values.

### 7.2.20.5.1.36 MULTIEDIT\_SetDefaultFont()

#### Description

Sets the default font for new MULTIEDIT widgets.

#### Prototype

```
void MULTIEDIT_SetDefaultFont(const GUI_FONT * pFont);
```

#### Parameters

Parameter	Description
<code>pFont</code>	Pointer to a GUI_FONT structure to be used.

### 7.2.20.5.1.37 MULTIEDIT\_SetDefaultHBorder()

#### Description

Sets the default horizontal border for new MULTIEDIT widgets.

#### Prototype

```
void MULTIEDIT_SetDefaultHBorder(unsigned HBorder);
```

#### Parameters

Parameter	Description
HBorder	New horizontal border to be used.

### 7.2.20.5.1.38 MULTIEDIT\_SetDefaultTextColor()

#### Description

Sets the default text color for new MULTIEDIT widgets.

#### Prototype

```
void MULTIEDIT_SetDefaultTextColor(GUI_COLOR Color,  
                                   unsigned Index);
```

#### Parameters

Parameter	Description
Color	Color to be used.
Index	See <i>MULTIEDIT color indexes</i> on page 2025 for a full list of permitted values.

### 7.2.20.5.1.39 MULTIEDIT\_SetFocusable()

#### Description

Sets the focusability of the given MULTIEDIT widget.

#### Prototype

```
void MULTIEDIT_SetFocusable(MULTIEDIT_HANDLE hObj,  
                             int State);
```

#### Parameters

Parameter	Description
<code>hObj</code>	Handle of MULTIEDIT widget.
<code>OnOff</code>	1 for enabling focusability, 0 for disabling.

#### Additional information

The text can not be aligned to the center if the widget is focusable. To change text alignment, the function `MULTIEDIT_SetTextAlign()` can be used.



#### 7.2.20.5.1.40 MULTIEDIT\_SetFont()

##### Description

Sets the font used to display the text and the prompt.

##### Prototype

```
void MULTIEDIT_SetFont(      MULTIEDIT_HANDLE  hObj,  
                           const GUI_FONT      * pFont);
```

##### Parameters

Parameter	Description
<code>hObj</code>	Handle of MULTIEDIT widget.
<code>pFont</code>	Pointer to font to be used.

### 7.2.20.5.1.41 MULTIEDIT\_SetHBorder()

#### Description

Sets the size of the border between the text and the widget in horizontal direction.

#### Prototype

```
void MULTIEDIT_SetHBorder(MULTIEDIT_HANDLE hObj,  
                          unsigned         HBorder);
```

#### Parameters

Parameter	Description
<code>hObj</code>	Handle of MULTIEDIT widget.
<code>HBorder</code>	Size of the border in pixels.

### 7.2.20.5.1.42 MULTIEDIT\_SetInsertMode()

#### Description

Enables/disables the insert mode. The default behaviour is overwrite mode.

#### Prototype

```
void MULTIEDIT_SetInsertMode(MULTIEDIT_HANDLE hObj,  
                             int OnOff);
```

#### Parameters

Parameter	Description
<code>hObj</code>	Handle of MULTIEDIT widget.
<code>OnOff</code>	1 for enabling insert mode, 0 for disabling.

### 7.2.20.5.1.43 MULTIEDIT\_SetInvertCursor()

#### Description

Enables/disables the inversion mode of cursor. The default behaviour is invert mode.

#### Prototype

```
void MULTIEDIT_SetInvertCursor(MULTIEDIT_HANDLE hObj,  
                               int OnOff);
```

#### Parameters

Parameter	Description
<a href="#">hObj</a>	Handle of MULTIEDIT widget.
<a href="#">OnOff</a>	1 for enabling invert mode, 0 for disabling.

#### Additional information

Cursor colors need to be set.

#### 7.2.20.5.1.44 MULTIEDIT\_SetMaxNumChars()

##### Description

Sets the maximum number of characters used by text and prompt.

##### Prototype

```
void MULTIEDIT_SetMaxNumChars (MULTIEDIT_HANDLE hObj,  
                               unsigned          MaxNumChars);
```

##### Parameters

Parameter	Description
<code>hObj</code>	Handle of the MULTIEDIT widget.
<code>MaxNumChars</code>	Maximum number of characters.

### 7.2.20.5.1.45 MULTIEDIT\_SetPasswordMode()

#### Description

Enables/disables the password mode.

#### Prototype

```
void MULTIEDIT_SetPasswordMode(MULTIEDIT_HANDLE hObj,  
                               int OnOff);
```

#### Parameters

Parameter	Description
<code>hObj</code>	Handle of the MULTIEDIT widget.
<code>OnOff</code>	1 for enabling password mode, 0 for disabling.

#### Additional information

The password mode enables you to conceal the user input.

### 7.2.20.5.1.46 MULTIEDIT\_SetPrompt()

#### Description

Sets the prompt text.

#### Prototype

```
void MULTIEDIT_SetPrompt(      MULTIEDIT_HANDLE  hObj,  
                             const char          * pPrompt);
```

#### Parameters

Parameter	Description
<code>hObj</code>	Handle of the MULTIEDIT widget.
<code>sPrompt</code>	Pointer to the new prompt text.

#### Additional information

The prompt text is displayed first. The cursor can not be moved into the prompt.

### 7.2.20.5.1.47 MULTIEDIT\_SetReadOnly()

#### Description

Enables/disables the read only mode.

#### Prototype

```
void MULTIEDIT_SetReadOnly(MULTIEDIT_HANDLE hObj,  
                           int OnOff);
```

#### Parameters

Parameter	Description
<code>hObj</code>	Handle of the MULTIEDIT widget.
<code>OnOff</code>	1 for enabling read-only mode, 0 for disabling.

#### Additional information

If the read only mode has been set the widget does not change the text. Only the cursor will be moved.



### 7.2.20.5.1.48 MULTIEDIT\_SetText()

#### Description

Sets the text to be handled by the MULTIEDIT widget.

#### Prototype

```
void MULTIEDIT_SetText(      MULTIEDIT_HANDLE  hObj,  
                           const char        * pNew);
```

#### Parameters

Parameter	Description
<code>hObj</code>	Handle of the MULTIEDIT widget.
<code>pNew</code>	Pointer to the text to be handled by the MULTIEDIT widget.

#### Additional information

The function copies the given text to the buffer allocated when creating the widget. The current text can be retrieved by `MULTIEDIT_GetText()`.

### 7.2.20.5.1.49 MULTIEDIT\_SetTextAlign()

#### Description

Sets the text alignment for the given MULTIEDIT widget.

#### Prototype

```
void MULTIEDIT_SetTextAlign(MULTIEDIT_HANDLE hObj,  
                             int Align);
```

#### Parameters

Parameter	Description
<code>hObj</code>	Handle of the MULTIEDIT widget.
<code>Align</code>	See <i>Text alignment flags</i> on page 286. <b>Only horizontal left and right alignment flags are applicable!</b>

#### Additional information

The text can not be horizontally centered if the widget is focusable. To change focusability of the widget, the function `MULTIEDIT_SetFocusable()` can be used.

### 7.2.20.5.1.50 MULTIEDIT\_SetTextColor()

#### Description

Sets the text color.

#### Prototype

```
void MULTIEDIT_SetTextColor(MULTIEDIT_HANDLE hObj,  
                           unsigned Index,  
                           GUI_COLOR color);
```

#### Parameters

Parameter	Description
<a href="#">hObj</a>	Handle of the MULTIEDIT widget.
<a href="#">Index</a>	See <i>MULTIEDIT color indexes</i> on page 2025 for a full list of permitted values.
<a href="#">Color</a>	Text color to be used.

### 7.2.20.5.1.51 MULTIEDIT\_SetUserData()

#### Description

Prototype explained at the beginning of the chapter as `<WIDGET>_SetUserData()` on page 1166.

### 7.2.20.5.1.52 MULTIEDIT\_SetWrapChar()

#### Description

Enables the char wrapping mode.

#### Prototype

```
void MULTIEDIT_SetWrapChar(MULTIEDIT_HANDLE hObj);
```

#### Parameters

Parameter	Description
<a href="#">hObj</a>	Handle of MULTIEDIT widget.

#### Additional information

If the char wrapping mode has been set the text will be wrapped at the last character that still fits in the line.

### 7.2.20.5.1.53 MULTIEDIT\_SetWrapNone()

#### Description

Enables the non wrapping mode.

#### Prototype

```
void MULTIEDIT_SetWrapNone (MULTIEDIT_HANDLE hObj) ;
```

#### Parameters

Parameter	Description
<a href="#">hObj</a>	Handle of MULTIEDIT widget.

#### Additional information

'Non wrapping' means line wrapping would be done only at new lines. If the horizontal size of the text exceeds the size of the client area the text will be scrolled.

### 7.2.20.5.1.54 MULTIEDIT\_SetWrapWord()

#### Description

Enables the word wrapping mode.

#### Prototype

```
void MULTIEDIT_SetWrapWord(MULTIEDIT_HANDLE hObj);
```

#### Parameters

Parameter	Description
<a href="#">hObj</a>	Handle of MULTIEDIT widget.

#### Additional information

If the word wrapping mode has been set the text at the end of a line will be wrapped at the beginning of the last word (if possible).

### 7.2.20.5.1.55 MULTIEDIT\_ShowCursor()

#### Description

This function enables or disables the cursor of the MULTIEDIT widget.

#### Prototype

```
int MULTIEDIT_ShowCursor(MULTIEDIT_HANDLE hObj,  
                        unsigned OnOff);
```

#### Parameters

Parameter	Description
<code>hObj</code>	Handle of MULTIEDIT widget.
<code>OnOff</code>	0 hide cursor, 1 show cursor

#### Return value

This function returns the previous state of the cursor.



## 7.2.20.5.2 Defines

### 7.2.20.5.2.1 MULTIEDIT color indexes

#### Description

Color indexes used by the MULTIEDIT widget.

#### Definition

```
#define MULTIEDIT_CI_EDIT      0
#define MULTIEDIT_CI_READONLY 1
```

#### Symbols

Definition	Description
<a href="#">MULTIEDIT_CI_EDIT</a>	Color in edit mode.
<a href="#">MULTIEDIT_CI_READONLY</a>	Color in read-only mode.

### 7.2.20.5.2.2 MULTIEDIT cursor color indexes

#### Description

Color indexes used for the cursor of the MULTIEDIT widget.

#### Definition

```
#define MULTIEDIT_CI_CURSOR_BK      0
#define MULTIEDIT_CI_CURSOR_FG      1
#define GUI_MULTIEDIT_SHOWCURSOR    (1 << 10)
#define GUI_MULTIEDIT_CURSORBLINK    (1 << 11)
```

#### Symbols

Definition	Description
MULTIEDIT_CI_CURSOR_BK	Background color for cursor
MULTIEDIT_CI_CURSOR_FG	Foreground color for cursor
GUI_MULTIEDIT_SHOWCURSOR	Internal use.
GUI_MULTIEDIT_CURSORBLINK	Internal use.

### 7.2.20.5.2.3 MULTIEDIT create flags

#### Description

Create flags that define the behavior of the FRAMEWIN widget. These flags are OR-combinable and can be specified upon creation of the widget via the `ExFlags` parameter of `MULTIEDIT_CreateEx()`.

#### Definition

```
#define MULTIEDIT_CF_READONLY      (1 << 0)
#define MULTIEDIT_CF_INSERT      (1 << 2)
#define MULTIEDIT_CF_AUTOSCROLLBAR_V (1 << 3)
#define MULTIEDIT_CF_AUTOSCROLLBAR_H (1 << 4)
#define MULTIEDIT_CF_PASSWORD    (1 << 5)
#define MULTIEDIT_CF_SHOWCURSOR (1 << 6)
#define MULTIEDIT_CF_MOTION_H    (1 << 7)
#define MULTIEDIT_CF_MOTION_V    (1 << 8)
#define MULTIEDIT_CF_USE_COPY    (1 << 9)
```

#### Symbols

Definition	Description
<code>MULTIEDIT_CF_READONLY</code>	Enables read only mode.
<code>MULTIEDIT_CF_INSERT</code>	Enables insert mode.
<code>MULTIEDIT_CF_AUTOSCROLLBAR_V</code>	Automatic use of a vertical scroll bar.
<code>MULTIEDIT_CF_AUTOSCROLLBAR_H</code>	Automatic use of a horizontal scroll bar.
<code>MULTIEDIT_CF_PASSWORD</code>	Enables password mode.
<code>MULTIEDIT_CF_SHOWCURSOR</code>	Shows the cursor.
<code>MULTIEDIT_CF_MOTION_H</code>	Enables motion support on X-axis.
<code>MULTIEDIT_CF_MOTION_V</code>	Enables motion support on Y-axis.
<code>MULTIEDIT_CF_USE_COPY</code>	Enables copyrect optimization

## 7.2.20.6 Example

The `Sample` folder contains the following example which shows how the widget can be used:

- `WIDGET_MultiEdit.c`

Note that several other examples also make use of this widget and may also be helpful to get familiar with it.

### Screenshot of `WIDGET_Multiedit.c`

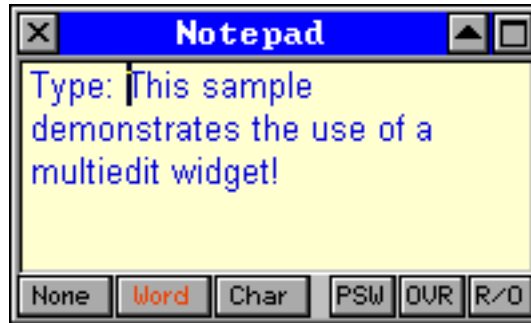

## 7.2.21 MULTIPAGE: Multiple page widget

A MULTIPAGE widget is analogous to the dividers in a notebook or the labels in a file cabinet. By using a MULTIPAGE widget, an application can define multiple pages for the same area of a window or dialog box. Each page consists of a certain type of information or a group of widgets that the application displays when the user selects the corresponding page. To select a page the tab of the page has to be clicked. If not all tabs can be displayed, the MULTIPAGE widget automatically shows a small scroll bar at the edge to scroll the pages. The `Sample` folder contains the file `WIDGET_Multipage.c` which shows how to create and use the MULTIPAGE widget.

### Note

All MULTIPAGE-related routines are located in the file(s) `MULTIPAGE*.c`, `MULTIPAGE.h`. All identifiers are prefixed `MULTIPAGE`.

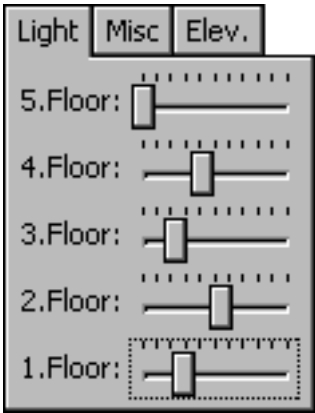
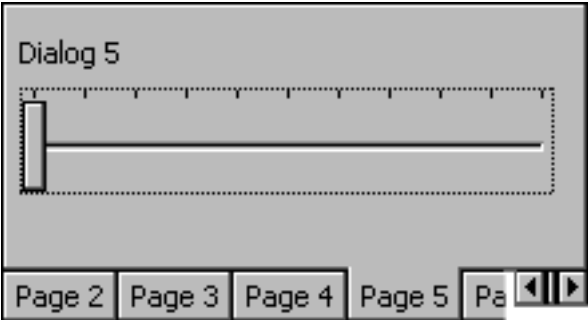
Description	MULTIPAGE widget
<p>MULTIPAGE widget with 3 pages, alignment top/left.</p>	
<p>MULTIPAGE widget with 6 pages, alignment bottom/right.</p>	

### Skining...

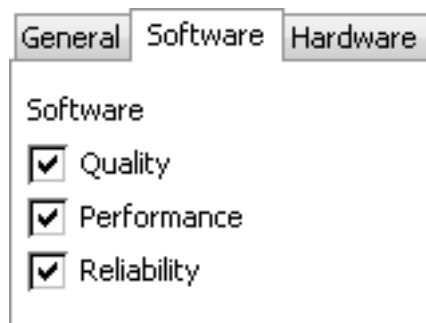

...is available for this widget. The screenshot above shows the widget using the default skin. Details can be found in the chapter *Skining* on page 2800.

### Note

This widget uses skinning. To change the look it is recommended to use the function `<WIDGET>_SetSkinFlexProps()`. Other functions to change the look might work only with the classic skin.

## Structure of MULTIPAGE widget

A MULTIPAGE widget with n pages consists of n+2 windows:

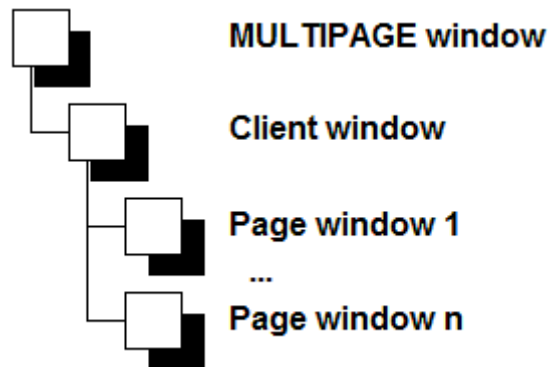

- 1 MULTIPAGE window
- 1 Client window
- n Page windows

The page windows will be added to the client window of the widget. The diagram at the right side shows the structure of the widget.

### 7.2.21.1 Configuration options

Type	Macro	Default	Description
N	MULTIPAGE_ALIGN_DEFAULT	MULTIPAGE_ALIGN_LEFT   MULTIPAGE_ALIGN_TOP	Default alignment.
N	MULTIPAGE_BKCOLOR0_DEFAULT	0xD0D0D0	Default background color of pages in disabled state.
N	MULTIPAGE_BKCOLOR1_DEFAULT	0xC0C0C0	Default background color of pages in enabled state.
S	MULTIPAGE_FONT_DEFAULT	&GUI_Font13_1	Default font used by the widget.
N	MULTIPAGE_TEXTCOLOR0_DEFAULT	0x808080	Default text color of pages in disabled state.
N	MULTIPAGE_TEXTCOLOR1_DEFAULT	0x000000	Default text color of pages in enabled state.

### 7.2.21.2 Predefined IDs

The following symbols define IDs which may be used to make MULTIPAGE widgets distinguishable from creation.

```
#define GUI_ID_MULTIPAGE0    0x230
#define GUI_ID_MULTIPAGE1    0x231
#define GUI_ID_MULTIPAGE2    0x232
#define GUI_ID_MULTIPAGE3    0x233
#define GUI_ID_MULTIPAGE4    0x234
#define GUI_ID_MULTIPAGE5    0x235
#define GUI_ID_MULTIPAGE6    0x236
#define GUI_ID_MULTIPAGE7    0x237
#define GUI_ID_MULTIPAGE8    0x238
#define GUI_ID_MULTIPAGE9    0x239
```

### 7.2.21.3 Notification codes

The following events are sent from the widget to its parent window as part of a WM\_NOTIFY\_PARENT message:

Message	Description
WM_NOTIFICATION_CLICKED	Widget has been clicked.
WM_NOTIFICATION_RELEASED	Widget has been released.
WM_NOTIFICATION_MOVED_OUT	Widget has been clicked and pointer has been moved out of the widget without releasing.
WM_NOTIFICATION_VALUE_CHANGED	The text of the widget has been changed.

### 7.2.21.4 Keyboard reaction

The widget reacts to the following keys if it has the input focus:

Key	Reaction
GUI_KEY_PGUP	Switches to the next page.
GUI_KEY_PGDOWN	Switches to the previous page.

### 7.2.21.5 MULTIPAGE API

The table below lists the available emWin MULTIPAGE-related routines in alphabetical order. Detailed descriptions of the routines follow.

#### Functions

Routine	Description
<code>MULTIPAGE_AddEmptyPage()</code>	Adds a page to a MULTIPAGE widget without the requirement to attach a window.
<code>MULTIPAGE_AddPage()</code>	Adds a page to a MULTIPAGE widget.
<code>MULTIPAGE_AttachWindow()</code>	Attaches a window to a certain page of the MULTIPAGE widget.
<code>MULTIPAGE_CreateEx()</code>	Creates a MULTIPAGE widget.
<code>MULTIPAGE_CreateIndirect()</code>	Creates a MULTIPAGE widget from a resource table entry.
<code>MULTIPAGE_CreateUser()</code>	Creates a MULTIPAGE widget using extra bytes as user data.
<code>MULTIPAGE_DeletePage()</code>	Deletes a page from a MULTIPAGE widget.
<code>MULTIPAGE_DisablePage()</code>	Disables a page from a MULTIPAGE widget.
<code>MULTIPAGE_EnablePage()</code>	Enables a page from a MULTIPAGE widget.
<code>MULTIPAGE_EnableScrollbar()</code>	Configures the given MULTIPAGE widget to make use of an automatic scroll bar.
<code>MULTIPAGE_GetBkColor()</code>	Returns the background color.
<code>MULTIPAGE_GetDefaultAlign()</code>	Returns the default tab alignment for new MULTIPAGE widgets.
<code>MULTIPAGE_GetDefaultBkColor()</code>	Returns the default background color for new MULTIPAGE widgets.
<code>MULTIPAGE_GetDefaultFont()</code>	Returns a pointer to the font used to display the text in the tabs of new MULTIPAGE widgets.



Routine	Description
<code>MULTIPAGE_GetDefaultTextColor()</code>	Returns the default text color used to display the text in the tabs of new MULTIPAGE widgets.
<code>MULTIPAGE_GetFont()</code>	Returns the font of the widget.
<code>MULTIPAGE_GetNumTabs()</code>	Returns the number of all tabs in a MULTIPAGE widget.
<code>MULTIPAGE_GetPageText()</code>	Returns the text of the given page.
<code>MULTIPAGE_GetSelection()</code>	Returns the current selection.
<code>MULTIPAGE_GetTabHeight()</code>	Returns the height for all tabs.
<code>MULTIPAGE_GetTabWidth()</code>	Returns the width for the given tab.
<code>MULTIPAGE_GetTextColor()</code>	Returns the text color of the widget.
<code>MULTIPAGE_GetUserData()</code>	Retrieves the data set with <code>MULTIPAGE_SetUserData()</code> .
<code>MULTIPAGE_GetWindow()</code>	Returns the handle of the window displayed in the given page.
<code>MULTIPAGE_IsPageEnabled()</code>	Returns if the given page of a MULTIEDIT widget is enabled or not.
<code>MULTIPAGE_SelectPage()</code>	Sets the currently selected page of a MULTIPAGE widget.
<code>MULTIPAGE_SetAlign()</code>	Sets the alignment for the tabs.
<code>MULTIPAGE_SetBitmap()</code>	Sets a bitmap to be displayed on the given tab.
<code>MULTIPAGE_SetBitmapEx()</code>	Sets a bitmap to be displayed at the specified position on the given tab.
<code>MULTIPAGE_SetBkColor()</code>	Sets the background color of the given MULTIPAGE widget.
<code>MULTIPAGE_SetDefaultAlign()</code>	Sets the default tab alignment for new MULTIPAGE widgets.
<code>MULTIPAGE_SetDefaultBkColor()</code>	Sets the default background color used for new MULTIPAGE widgets.
<code>MULTIPAGE_SetDefaultBorderSizeX()</code>	Sets the default border size on the x-axis.
<code>MULTIPAGE_SetDefaultBorderSizeY()</code>	Sets the default border size on the y-axis.
<code>MULTIPAGE_SetDefaultFont()</code>	Sets the default font used by new MULTIPAGE widgets.
<code>MULTIPAGE_SetDefaultTextColor()</code>	Sets the default text color used by new MULTIPAGE widgets.
<code>MULTIPAGE_SetFont()</code>	Selects the font for the widget.
<code>MULTIPAGE_SetRotation()</code>	Sets the rotation mode of the given widget.
<code>MULTIPAGE_SetTabHeight()</code>	Sets the height for all tabs.
<code>MULTIPAGE_SetTabWidth()</code>	Sets the width for the given tab.
<code>MULTIPAGE_SetText()</code>	Sets the text displayed in the tab of a given page.
<code>MULTIPAGE_SetTextAlign()</code>	Sets the text alignment for the given MULTIPAGE widget.
<code>MULTIPAGE_SetTextColor()</code>	Sets the text color.
<code>MULTIPAGE_SetUserData()</code>	Sets the extra data of a MULTIPAGE widget.

## Defines

Group of defines	Description
<a href="#">MULTIPAGE alignment flags</a>	Alignment flags used by <code>MULTIPAGE_SetAlign()</code> .
<a href="#">MULTIPAGE bitmap indexes</a>	Bitmap indexes used by the MULTIPAGE widget.
<a href="#">MULTIPAGE color indexes</a>	Color indexes used by the MULTIPAGE widget.
<a href="#">MULTIPAGE create flags</a>	Create flags used by the MULTIPAGE widget.

## 7.2.21.5.1 Functions

### 7.2.21.5.1.1 MULTIPAGE\_AddEmptyPage()

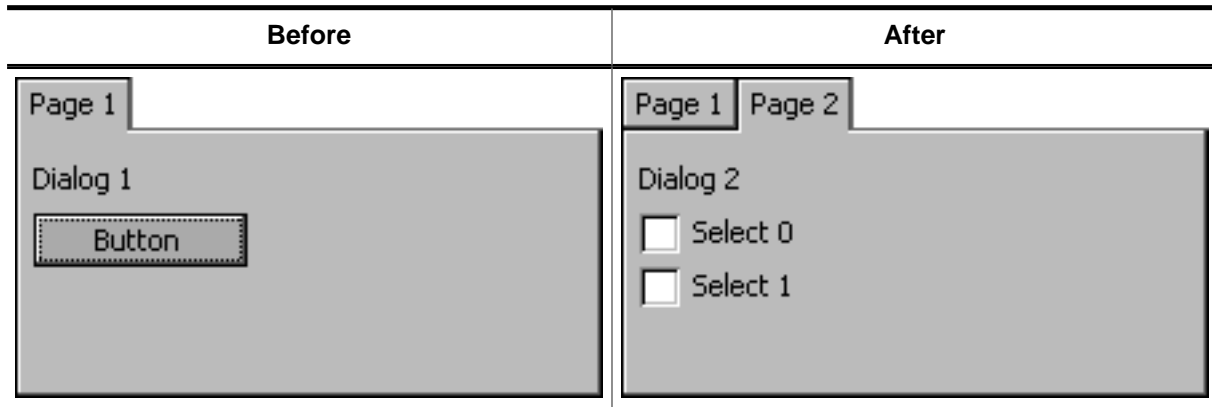

#### Description

Adds a new page to a given MULTIPAGE widget.

#### Prototype

```
void MULTIPAGE_AddEmptyPage(    MULTIPAGE_Handle  hObj,
                               WM_HWIN                  hWin,
                               const char                 * pText);
```

#### Parameters

Parameter	Description
<code>hObj</code>	Handle of MULTIPAGE widget.
<code>hWin</code>	Handle of window to be shown in the given page.
<code>pText</code>	Pointer to text to be displayed in the tab of the page.

#### Additional information

It is recommended, that all windows added to a MULTIPAGE widget handle the complete client area of the MULTIPAGE widget when processing the WM\_PAINT message. If no window has to be added, `hWin` can be specified with 0.

### 7.2.21.5.1.2 MULTIPAGE\_AddPage()

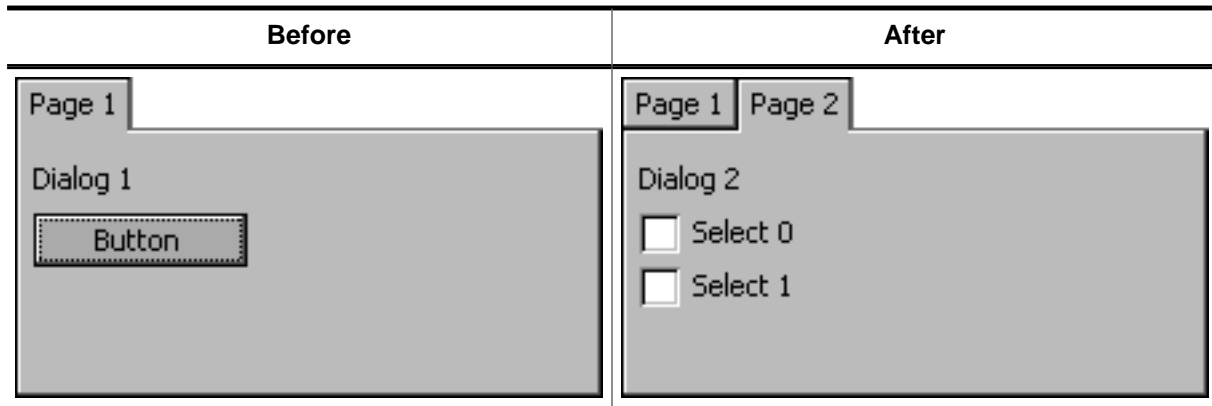

#### Description

Adds a new page to a given MULTIPAGE widget.

#### Prototype

```
void MULTIPAGE_AddPage(    MULTIPAGE_Handle  hObj,
                          WM_HWIN                hWin,
                          const char                * pText);
```

#### Parameters

Parameter	Description
<code>hObj</code>	Handle of MULTIPAGE widget.
<code>hWin</code>	Handle of window to be shown in the given page.
<code>pText</code>	Pointer to text to be displayed in the tab of the page.

#### Additional information

It is recommended, that all windows added to a MULTIPAGE widget handle the complete client area of the MULTIPAGE widget when processing the `WM_PAINT` message.

### 7.2.21.5.1.3 MULTIPAGE\_AttachWindow()

#### Description

Attaches a window to a certain page of the MULTIPAGE widget.

#### Prototype

```
WM_HWIN MULTIPAGE_AttachWindow(MULTIPAGE_Handle hObj,
                                unsigned         Index,
                                WM_HWIN         hWin);
```

#### Parameters

Parameter	Description
<a href="#">hObj</a>	Handle of MULTIPAGE widget.
<a href="#">Index</a>	<a href="#">Index</a> of the page the window has to be added to.
<a href="#">pText</a>	Pointer to text to be displayed in the tab of the page.

#### Additional information

It is recommended, that all windows added to a MULTIPAGE widget handle the complete client area of the MULTIPAGE widget when processing the `WM_PAINT` message.

### 7.2.21.5.1.4 MULTIPAGE\_CreateEx()

#### Description

Creates a MULTIPAGE widget of a specified size at a specified position.

#### Prototype

```
MULTIPAGE_Handle MULTIPAGE_CreateEx(int    x0,
                                     int    y0,
                                     int    xSize,
                                     int    ySize,
                                     WM_HWIN hParent,
                                     int    WinFlags,
                                     int    ExFlags,
                                     int    Id);
```

#### Parameters

Parameter	Description
<code>x0</code>	X-position of the MULTIPAGE widget (in parent coordinates).
<code>y0</code>	Y-position of the MULTIPAGE widget (in parent coordinates).
<code>xSize</code>	Horizontal size of the MULTIPAGE widget (in pixels).
<code>ySize</code>	Vertical size of the MULTIPAGE widget (in pixels).
<code>hParent</code>	Handle of parent window. If 0, the new widget will be a child of the desktop (top-level window).
<code>WinFlags</code>	Window create flags. Typically <code>WM_CF_SHOW</code> in order to make the widget visible immediately (refer to <i>Window create flags</i> on page 1146 for a list of available parameter values).
<code>ExFlags</code>	Not used yet, reserved for future use.
<code>Id</code>	Window ID of the MULTIPAGE widget.

#### Return value

Handle of the new MULTIPAGE widget.

#### Additional information

The size of the tabs depends on the size of the font used for the MULTIPAGE widget.

### 7.2.21.5.1.5 MULTIPAGE\_CreateIndirect()

#### Description

The prototype of this function is explained at the beginning of this chapter. Details can be found in the description of the function `<WIDGET>_CreateIndirect()` on page 1161. The element `Para` of the according `GUI_WIDGET_CREATE_INFO` structure is not used. The element `Flags` is used according to the parameter `ExFlags` of the function `MULTIPAGE_CreateEx()`.

### 7.2.21.5.1.6 MULTIPAGE\_CreateUser()

#### Description

Prototype explained at the beginning of the chapter as `<WIDGET>_CreateUser()` on page 1162. For a detailed description of the parameters the function `MULTIPAGE_CreateEx()` can be referred to.



### 7.2.21.5.1.7 MULTIPAGE\_DeletePage()

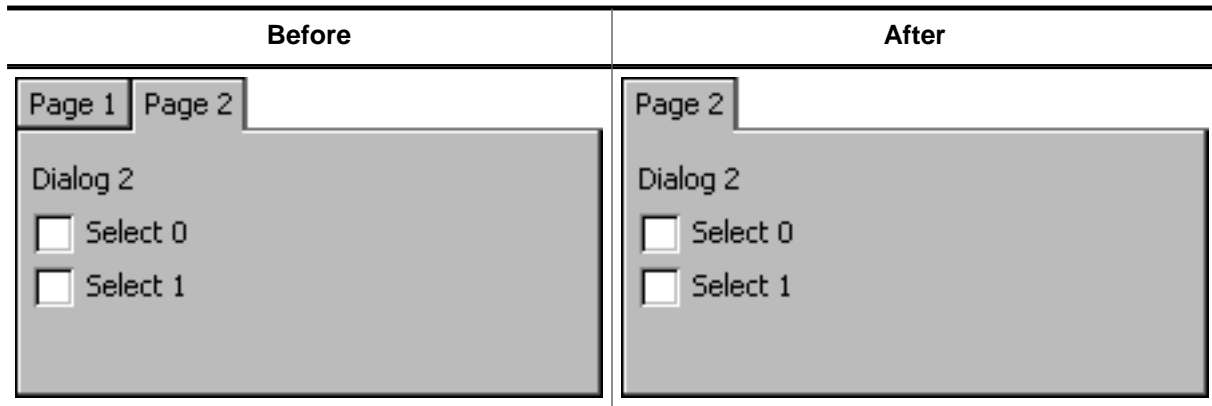

#### Description

Removes a page from a MULTIPAGE widget and optional deletes the window.

#### Prototype

```
void MULTIPAGE_DeletePage(MULTIPAGE_Handle hObj,
                          unsigned Index,
                          int Delete);
```

#### Parameters

Parameter	Description
<code>hObj</code>	Handle of MULTIPAGE widget.
<code>Index</code>	Zero based index of the page to be removed from the MULTIPAGE widget.
<code>Delete</code>	If >0 the window attached to the page will be deleted.

### 7.2.21.5.1.8 MULTIPAGE\_DisablePage()

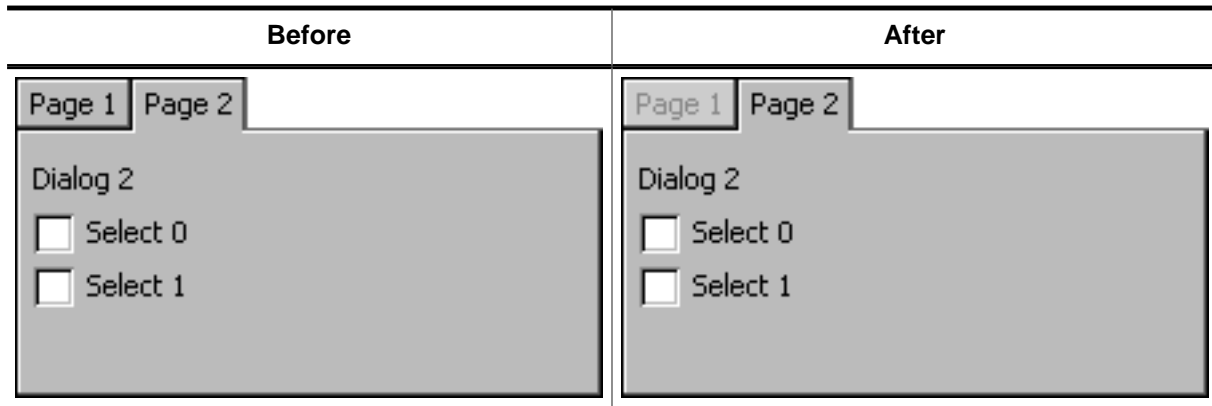

#### Description

Disables a page from a MULTIPAGE widget.

#### Prototype

```
void MULTIPAGE_DisablePage(MULTIPAGE_Handle hObj,
                           unsigned Index);
```

#### Parameters

Parameter	Description
<code>hObj</code>	Handle of MULTIPAGE widget.
<code>Index</code>	Zero based index of the page to be disabled.

#### Additional information

A disabled page of a window can not be selected by clicking the tab of the page. The default state of MULTIEDIT pages is 'enabled'.

### 7.2.21.5.1.9 MULTIPAGE\_EnablePage()

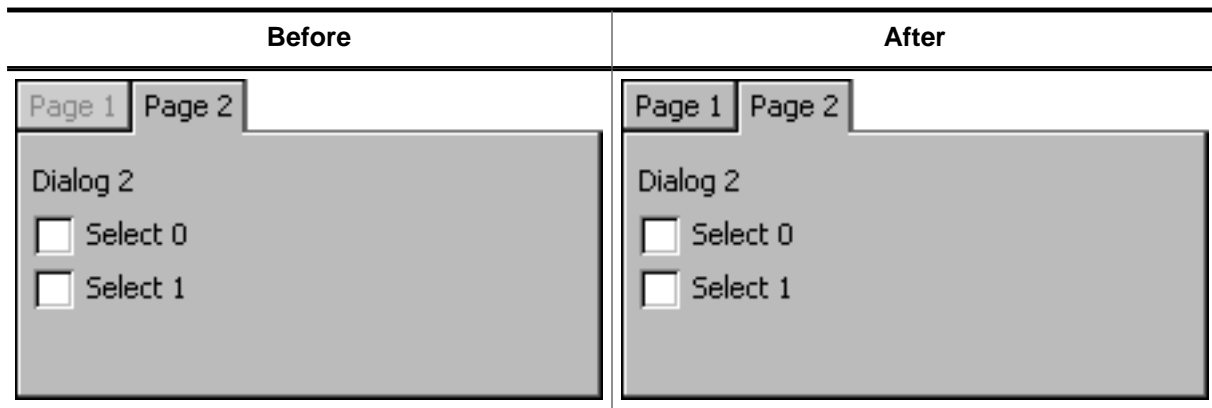

#### Description

Enables a page of a MULTIPAGE widget.

#### Prototype

```
void MULTIPAGE_EnablePage(MULTIPAGE_Handle hObj,
                          unsigned          Index);
```

#### Parameters

Parameter	Description
<code>hObj</code>	Handle of MULTIPAGE widget.

#### Additional information

The default state of MULTIPAGE pages is 'enabled'.

### 7.2.21.5.1.10 MULTIPAGE\_EnableScrollbar()

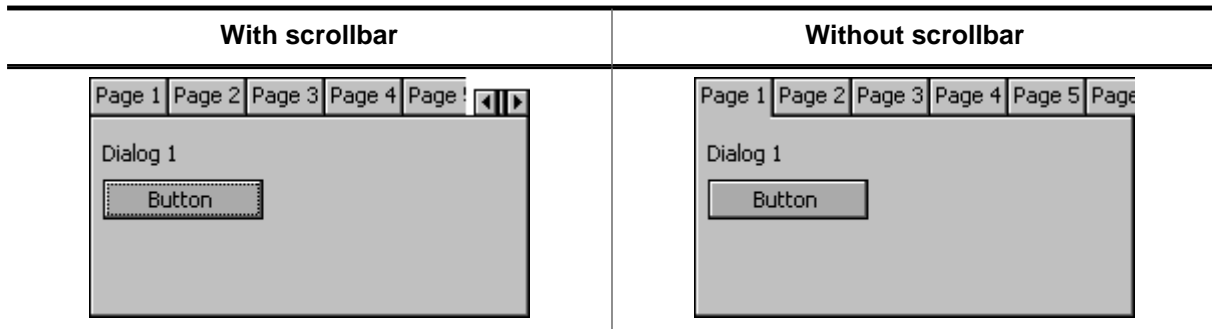

#### Description

Configures the given MULTIPAGE widget to make use of an automatic scroll bar.

#### Prototype

```
void MULTIPAGE_EnableScrollbar(MULTIPAGE_Handle hObj,
                               unsigned         OnOff);
```

#### Parameters

Parameter	Description
<code>hObj</code>	Handle of MULTIPAGE widget.
<code>OnOff</code>	1 = Enable automatic scroll bar. 0 = Disable automatic scroll bar.

#### Additional information

Calling this function takes effect only before the first page has been added to the widget. The automatic scroll bar is enabled by default.

### 7.2.21.5.1.11 MULTIPAGE\_GetBkColor()

#### Description

Returns the background color of the widget.

#### Prototype

```
GUI_COLOR MULTIPAGE_GetBkColor(MULTIPAGE_Handle hObj,  
                                unsigned Index);
```

#### Parameters

Parameter	Description
<a href="#">hObj</a>	Handle of MULTIPAGE widget.
<a href="#">Index</a>	See <i>MULTIPAGE color indexes</i> on page 2081 for a full list of permitted values.

#### Return value

The background color of the given widget.

### 7.2.21.5.1.12 MULTIPAGE\_GetDefaultAlign()

#### Description

Returns the default tab alignment for new MULTIPAGE widgets.

#### Prototype

```
unsigned MULTIPAGE_GetDefaultAlign(void);
```

#### Return value

Default tab alignment for new MULTIPAGE widgets.

#### Additional information

The following table shows the alignment values returned by this function:

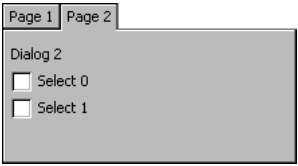
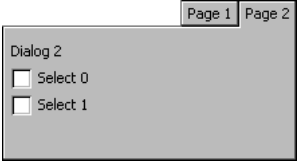
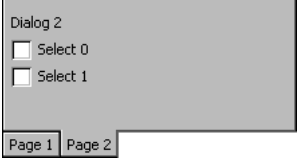
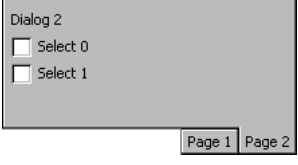
Alignment	Appearance of MULTIPAGE widget
MULTIPAGE_ALIGN_LEFT   MULTIPAGE_ALIGN_TOP	
MULTIPAGE_ALIGN_RIGHT   MULTIPAGE_ALIGN_TOP	
MULTIPAGE_ALIGN_LEFT   MULTIPAGE_ALIGN_BOTTOM	
MULTIPAGE_ALIGN_RIGHT   MULTIPAGE_ALIGN_BOTTOM	

### 7.2.21.5.1.13 MULTIPAGE\_GetDefaultBkColor()

#### Description

Returns the default background color for new MULTIPAGE widgets.

#### Prototype

```
GUI_COLOR MULTIPAGE_GetDefaultBkColor(unsigned Index);
```

#### Parameters

Parameter	Description
<a href="#">Index</a>	See <i>MULTIPAGE color indexes</i> on page 2081 for a full list of permitted values.

#### Return value

Default background color for new MULTIPAGE widgets.

#### 7.2.21.5.1.14 MULTIPAGE\_GetDefaultFont()

##### Description

Returns a pointer to the font used to display the text in the tabs of new MULTIPAGE widgets.

##### Prototype

```
GUI_FONT *MULTIPAGE_GetDefaultFont(void);
```

##### Return value

Pointer to the font used to display the text in the tabs of new MULTIPAGE widgets.



### 7.2.21.5.1.15 MULTIPAGE\_GetDefaultTextColor()

#### Description

Returns the default text color used to display the text in the tabs of new MULTIPAGE widgets.

#### Prototype

```
GUI_COLOR MULTIPAGE_GetDefaultTextColor(unsigned Index);
```

#### Parameters

Parameter	Description
<a href="#">Index</a>	See <i>MULTIPAGE color indexes</i> on page 2081 for a full list of permitted values.

#### Return value

Default text color used to display the text in the tabs of new MULTIPAGE widgets.

### 7.2.21.5.1.16 MULTIPAGE\_GetFont()

#### Description

Returns the font of the widget.

#### Prototype

```
GUI_FONT *MULTIPAGE_GetFont(MULTIPAGE_Handle hObj);
```

#### Parameters

Parameter	Description
<a href="#">hObj</a>	Handle of MULTIPAGE widget.

#### Return value

A pointer to the font of the given widget.

### 7.2.21.5.1.17 MULTIPAGE\_GetNumTabs()

#### Description

Returns the number of all tabs in a MULTIPAGE widget.

#### Prototype

```
int MULTIPAGE_GetNumTabs(MULTIPAGE_Handle hObj);
```

#### Parameters

Parameter	Description
<a href="#">hObj</a>	Handle of MULTIPAGE widget.

#### Return value

Number of all tabs in a MULTIPAGE widget.

### 7.2.21.5.1.18 MULTIPAGE\_GetPageText()

#### Description

Returns the text of the given page.

#### Prototype

```
int MULTIPAGE_GetPageText (MULTIPAGE_Handle hObj,  
                           unsigned Index,  
                           char * pBuffer,  
                           int MaxLen);
```

#### Parameters

Parameter	Description
<a href="#">hObj</a>	Handle of MULTIPAGE widget.
<a href="#">Index</a>	<a href="#">Index</a> of the page.
<a href="#">pBuffer</a>	User defined buffer which is filled with the page text.
<a href="#">MaxLen</a>	Maximum length of the text to be copied.

#### Return value

Length of the copied text.

### 7.2.21.5.1.19 MULTIPAGE\_GetSelection()

#### Description

Returns the zero based index of the currently selected page of a MULTIPAGE widget.

#### Prototype

```
int MULTIPAGE_GetSelection(MULTIPAGE_Handle hObj);
```

#### Parameters

Parameter	Description
<a href="#">hObj</a>	Handle of MULTIPAGE widget.

#### Return value

Zero-based index of the currently selected page of a MULTIPAGE widget.

### 7.2.21.5.1.20 MULTIPAGE\_GetTabHeight()

#### Description

Returns the height for all tabs.

#### Prototype

```
int MULTIPAGE_GetTabHeight(MULTIPAGE_Handle hObj);
```

#### Parameters

Parameter	Description
<a href="#">hObj</a>	Handle of MULTIPAGE widget.

#### Return value

Height for all tabs in a MULTIPAGE widget.

### 7.2.21.5.1.21 MULTIPAGE\_GetTabWidth()

#### Description

Returns the width for the given tab.

#### Prototype

```
int MULTIPAGE_GetTabWidth(MULTIPAGE_Handle hObj,  
                           int Index);
```

#### Parameters

Parameter	Description
<a href="#">hObj</a>	Handle of MULTIPAGE widget.
<a href="#">Index</a>	<a href="#">Index</a> of the tab.

#### Return value

Width of a specific tab in a MULTIPAGE widget.

### 7.2.21.5.1.22 MULTIPAGE\_GetTextColor()

#### Description

Returns the text color of the widget.

#### Prototype

```
GUI_COLOR MULTIPAGE_GetTextColor(MULTIPAGE_Handle hObj,  
                                unsigned          Index);
```

#### Parameters

Parameter	Description
<a href="#">hObj</a>	Handle of MULTIPAGE widget.
<a href="#">Index</a>	See <i>MULTIPAGE color indexes</i> on page 2081 for a full list of permitted values.

#### Return value

The text color of the given widget.



### 7.2.21.5.1.23 MULTIPAGE\_GetUserData()

#### Description

Prototype explained at the beginning of the chapter as `<WIDGET>_GetUserData()` on page 1165.

### 7.2.21.5.1.24 MULTIPAGE\_GetWindow()

#### Description

Returns the handle of the window displayed in the given page.

#### Prototype

```
WM_HWIN MULTIPAGE_GetWindow(MULTIPAGE_Handle hObj,  
                             unsigned Index);
```

#### Parameters

Parameter	Description
<a href="#">hObj</a>	Handle of MULTIPAGE widget.
<a href="#">Index</a>	Zero-based index of page.

#### Return value

Handle of the window displayed in the given page.

### 7.2.21.5.1.25 MULTIPAGE\_IsPageEnabled()

#### Description

Returns if the given page of a MULTIEDIT widget is enabled or not.

#### Prototype

```
int MULTIPAGE_IsPageEnabled(MULTIPAGE_Handle hObj,  
                             unsigned Index);
```

#### Parameters

Parameter	Description
<a href="#">hObj</a>	Handle of MULTIPAGE widget.
<a href="#">Index</a>	Zero-based index of requested page.

#### Return value

- 1 if the given page is enabled.
- 0 if the given page is disabled.

### 7.2.21.5.1.26 MULTIPAGE\_SelectPage()

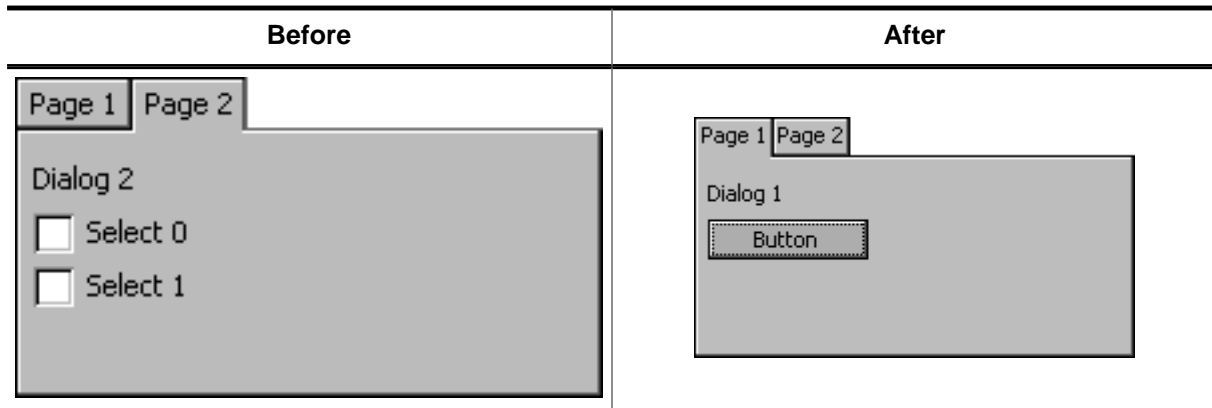

#### Description

Sets the currently selected page of a MULTIPAGE widget.

#### Prototype

```
void MULTIPAGE_SelectPage(MULTIPAGE_Handle hObj,
                          unsigned Index);
```

#### Parameters

Parameter	Description
<code>hObj</code>	Handle of MULTIPAGE widget.
<code>Index</code>	Zero-based index of page to be selected.

### 7.2.21.5.1.27 MULTIPAGE\_SetAlign()

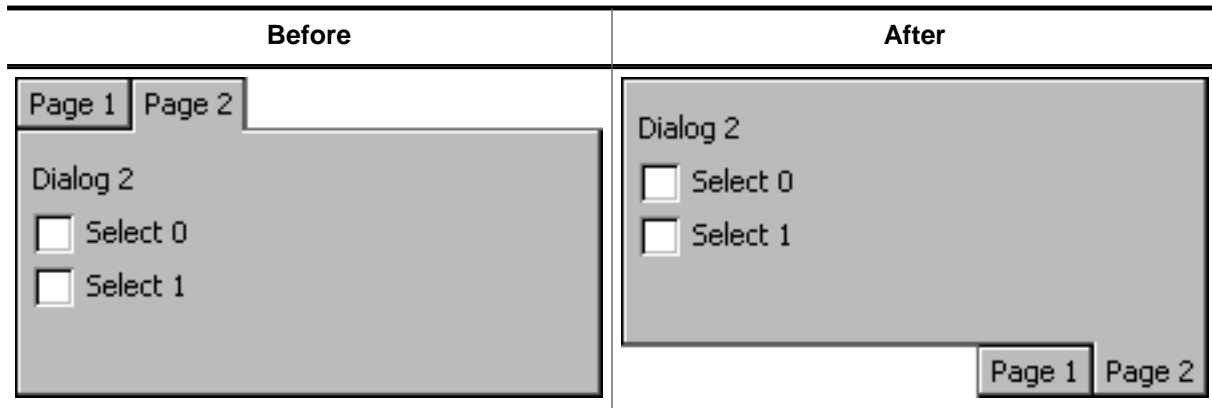

#### Description

Sets the tab alignment for the given MULTIPAGE widget.

#### Prototype

```
void MULTIPAGE_SetAlign(MULTIPAGE_Handle hObj,
                        unsigned          Align);
```

#### Parameters

Parameter	Description
<code>hObj</code>	Handle of MULTIPAGE widget.
<code>Align</code>	See <i>MULTIPAGE alignment flags</i> on page 2079 for a full list of permitted values.

#### Additional information

For more information, refer to `MULTIPAGE_GetDefaultAlign()`.

### 7.2.21.5.1.28 MULTIPAGE\_SetBitmap()

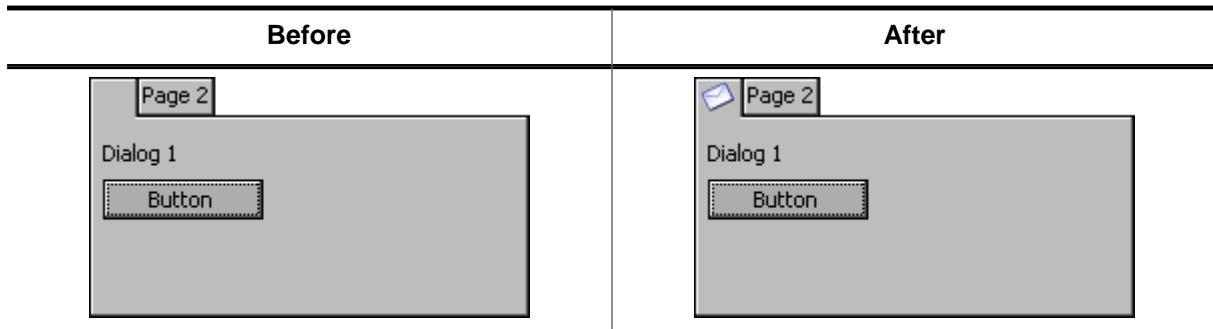

#### Description

Sets a bitmap to be displayed on the given tab. The bitmap is horizontally and vertically aligned to the center of the tab.

#### Prototype

```
int MULTIPAGE_SetBitmap(    MULTIPAGE_Handle  hObj,
                           const GUI_BITMAP  * pBitmap,
                           int                Index,
                           int                State);
```

#### Parameters

Parameter	Description
<code>hObj</code>	Handle of MULTIPAGE widget.
<code>pBitmap</code>	Pointer to the bitmap to be used for the given tab.
<code>Index</code>	<code>Index</code> of the tab.
<code>State</code>	<code>State</code> of the tab for which the bitmap has to be used. See <i>MULTIPAGE bitmap indexes</i> on page 2080 for a full list of permitted values.

#### Return value

0        on success  
1        on error.

### 7.2.21.5.1.29 MULTIPAGE\_SetBitmapEx()

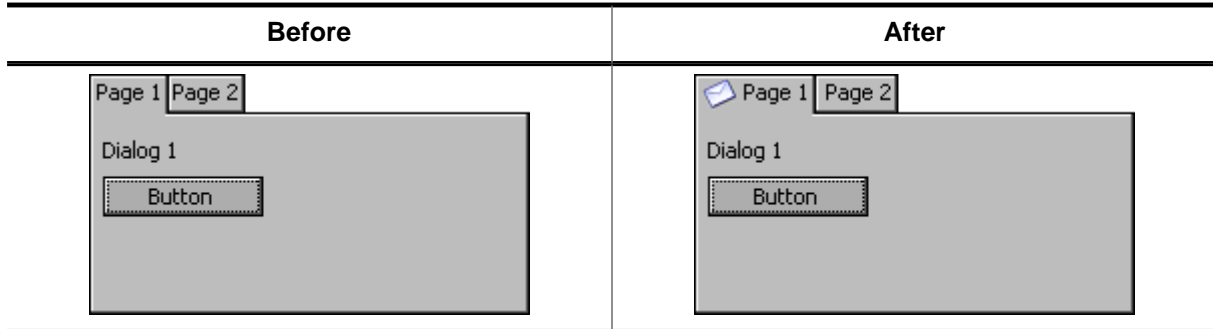

#### Description

Sets a bitmap to be displayed on the given tab adjusting the position from the center to the right, left, top and bottom according to the *x* and *y* values.

#### Prototype

```
int MULTIPAGE_SetBitmapEx(    MULTIPAGE_Handle  hObj,
                             const GUI_BITMAP    * pBitmap,
                             int                 x,
                             int                 y,
                             int                 Index,
                             int                 State);
```

#### Parameters

Parameter	Description
<i>hObj</i>	Handle of the MULTIPAGE widget.
<i>pBitmap</i>	Pointer to the bitmap to be used for the given tab.
<i>x</i>	Adjustment value for the <i>x</i> position of the bitmap. 0 means horizontally centered.
<i>y</i>	Adjustment value for the <i>y</i> position of the bitmap. 0 means vertically centered.
<i>Index</i>	<i>Index</i> of the tab.
<i>State</i>	<i>State</i> of the tab for which the bitmap has to be used. See <i>MULTIPAGE bitmap indexes</i> on page 2080 for a full list of permitted values.

#### Return value

0        on success  
1        on error.

### 7.2.21.5.1.30 MULTIPAGE\_SetBkColor()

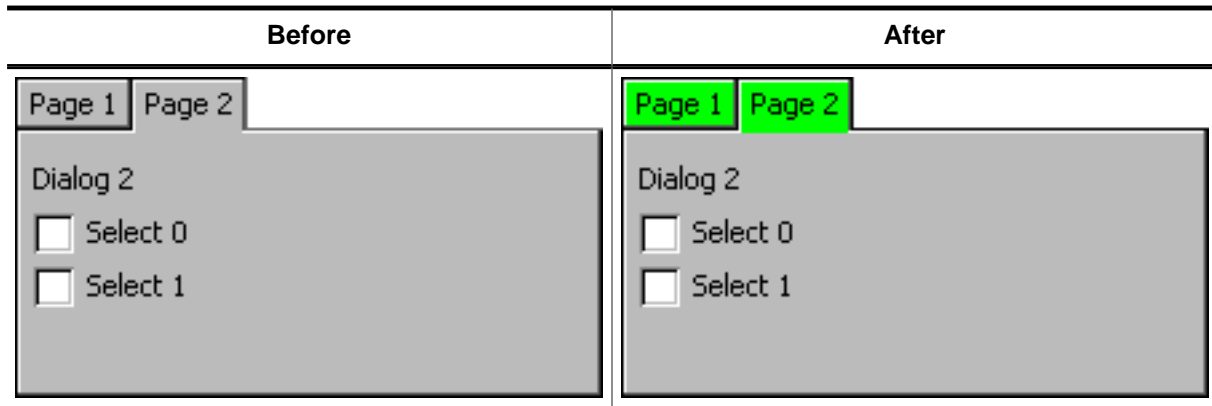

#### Description

Sets the background color of the given MULTIPAGE widget.

#### Prototype

```
void MULTIPAGE_SetBkColor(MULTIPAGE_Handle hObj,
                          GUI_COLOR       Color,
                          unsigned        Index);
```

#### Parameters

Parameter	Description
<code>hObj</code>	Handle of MULTIPAGE widget.
<code>Color</code>	<code>Color</code> to be used.
<code>Index</code>	See <i>MULTIPAGE color indexes</i> on page 2081 for a full list of permitted values.

#### Additional information

The function only sets the background color for the MULTIPAGE widget. The child windows added to the widget are not affected. That means if the complete client area is drawn by windows added to the widget, only the background color of the tabs changes.



### 7.2.21.5.1.31 MULTIPAGE\_SetDefaultAlign()

#### Description

Sets the default tab alignment for new MULTIPAGE widgets.

#### Prototype

```
void MULTIPAGE_SetDefaultAlign(unsigned Align);
```

#### Parameters

Parameter	Description
<a href="#">Align</a>	Tab alignment used for new MULTIPAGE widgets.

#### Additional information

For more information about the tab alignment, refer to `MULTIPAGE_GetDefaultAlign()` and `MULTIPAGE_SetAlign()`.

### 7.2.21.5.1.32 MULTIPAGE\_SetDefaultBkColor()

#### Description

Sets the default background color used for new MULTIPAGE widgets.

#### Prototype

```
void MULTIPAGE_SetDefaultBkColor(GUI_COLOR Color,  
                                unsigned Index);
```

#### Parameters

Parameter	Description
Color	Color to be used.
Index	See <i>MULTIPAGE color indexes</i> on page 2081 for a full list of permitted values.

### 7.2.21.5.1.33 MULTIPAGE\_SetDefaultBorderSizeX()

#### Description

Sets the default border size on the x-axis.

#### Prototype

```
void MULTIPAGE_SetDefaultBorderSizeX(unsigned Size);
```

#### Parameters

Parameter	Description
Size	Border size to be used.

### 7.2.21.5.1.34 MULTIPAGE\_SetDefaultBorderSizeY()

#### Description

Sets the default border size on the y-axis.

#### Prototype

```
void MULTIPAGE_SetDefaultBorderSizeY(unsigned Size);
```

#### Parameters

Parameter	Description
Size	Border size to be used.

### 7.2.21.5.1.35 MULTIPAGE\_SetDefaultFont()

#### Description

Sets the default font used to display the text in the tabs of new MULTIPAGE widgets.

#### Prototype

```
void MULTIPAGE_SetDefaultFont(const GUI_FONT * pFont);
```

#### Parameters

Parameter	Description
<code>pFont</code>	Pointer to GUI_FONT structure to be used.

#### Additional information

The horizontal and vertical size of the tabs depends on the size of the used font.

### 7.2.21.5.1.36 MULTIPAGE\_SetDefaultTextColor()

#### Description

Sets the default text color used to display the text in the tabs of new MULTIPAGE widgets.

#### Prototype

```
void MULTIPAGE_SetDefaultTextColor(GUI_COLOR Color,  
                                   unsigned Index);
```

#### Parameters

Parameter	Description
Color	Color to be used.
Index	See <i>MULTIPAGE color indexes</i> on page 2081 for a full list of permitted values.

### 7.2.21.5.1.37 MULTIPAGE\_SetFont()

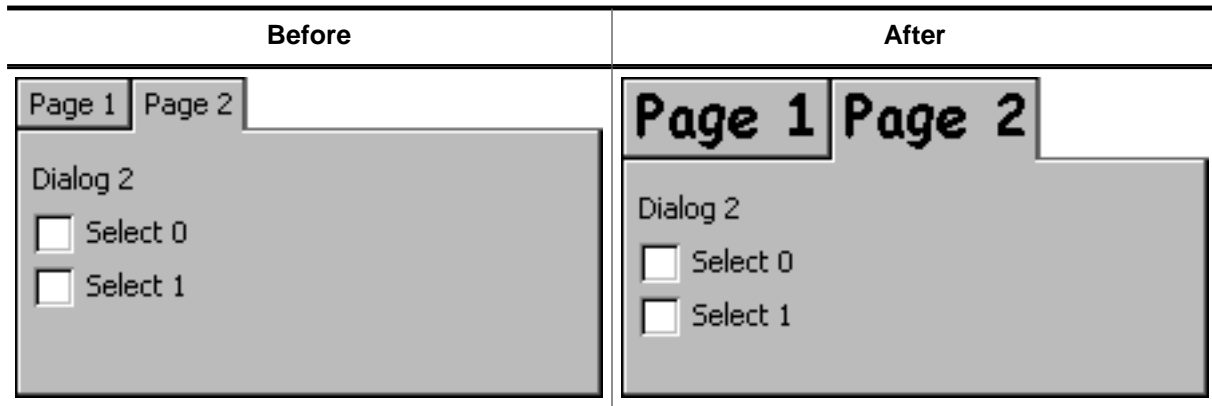

#### Description

Sets the font used to display the text in the tabs of a given MULTIPAGE widget.

#### Prototype

```
void MULTIPAGE_SetFont(      MULTIPAGE_Handle  hObj,
                           const GUI_FONT      * pFont);
```

#### Parameters

Parameter	Description
<code>hObj</code>	Handle of MULTIPAGE widget.
<code>pFont</code>	Pointer to GUI_FONT structure used to display the text in the tabs.

#### Additional information

The vertical and horizontal size of the tabs depend on the size of the used font and the text shown in the tabs.

### 7.2.21.5.1.38 MULTIPAGE\_SetRotation()

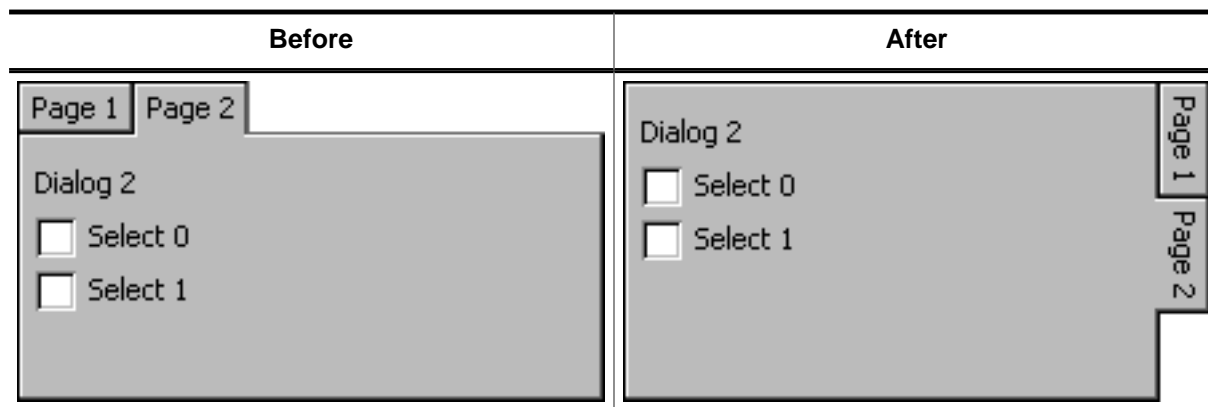

#### Description

Sets the rotation mode of the given widget.

#### Prototype

```
void MULTIPAGE_SetRotation(MULTIPAGE_Handle hObj,
                           unsigned Rotation);
```

#### Parameters

Parameter	Description
<code>hObj</code>	Handle of MULTIPAGE widget.
<code>Rotation</code>	<code>Rotation</code> mode. See <i>MULTIPAGE create flags</i> on page 2082.



### 7.2.21.5.1.39 MULTIPAGE\_SetTabHeight()

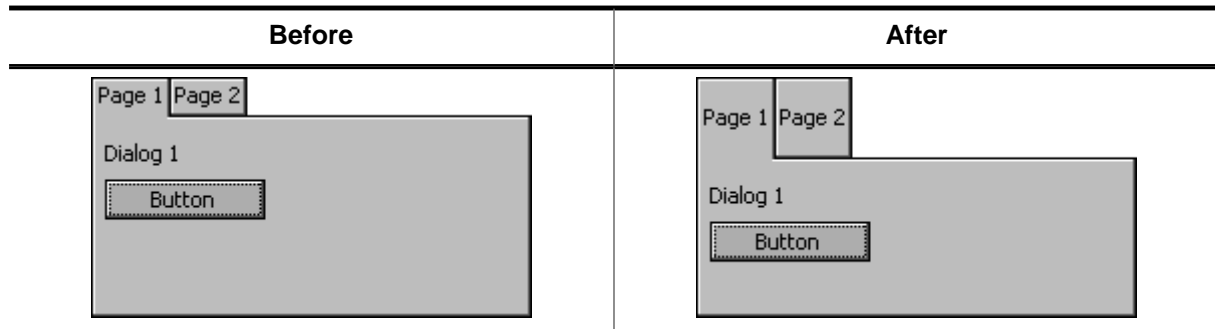

#### Description

Sets the height for all tabs.

#### Prototype

```
void MULTIPAGE_SetTabHeight(MULTIPAGE_Handle hObj,
                           int Height);
```

#### Parameters

Parameter	Description
<code>hObj</code>	Handle of MULTIPAGE widget.
<code>Height</code>	<code>Height</code> to be set.

### 7.2.21.5.1.40 MULTIPAGE\_SetTabWidth()

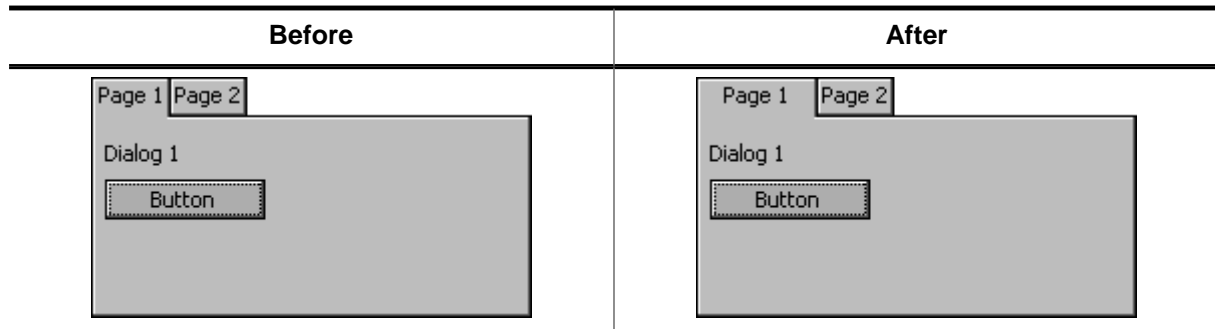

#### Description

Sets the width for the given tab.

#### Prototype

```
void MULTIPAGE_SetTabWidth(MULTIPAGE_Handle hObj,
                           int Width,
                           int Index);
```

#### Parameters

Parameter	Description
<code>hObj</code>	Handle of MULTIPAGE widget.
<code>Width</code>	<code>Width</code> to be set.
<code>Index</code>	<code>Index</code> of the tab.

### 7.2.21.5.1.41 MULTIPAGE\_SetText()

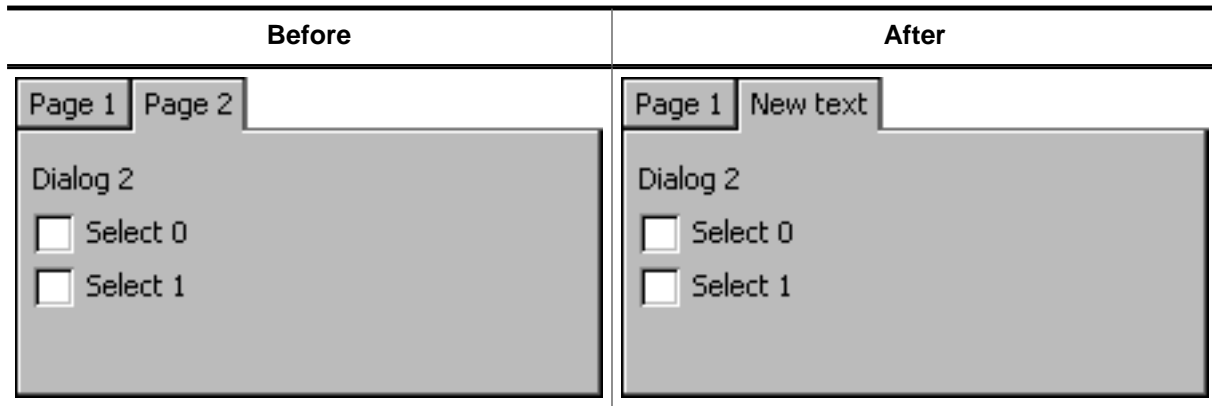

#### Description

Sets the text displayed in the tab of a given page.

#### Prototype

```
void MULTIPAGE_SetText(    MULTIPAGE_Handle  hObj,
                          const char          * s,
                          unsigned           Index);
```

#### Parameters

Parameter	Description
<code>hObj</code>	Handle of MULTIPAGE widget.
<code>pText</code>	Pointer to the text to be displayed.
<code>Index</code>	Zero based index of the page.

### 7.2.21.5.1.42 MULTIPAGE\_SetTextAlign()

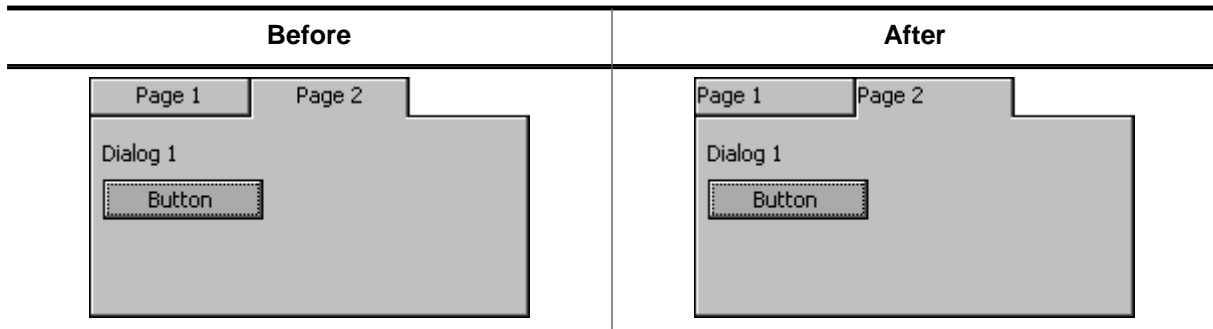

#### Description

Sets the text alignment for the given MULTIPAGE widget.

#### Prototype

```
void MULTIPAGE_SetTextAlign(MULTIPAGE_Handle hObj,
                           unsigned        Align);
```

#### Parameters

Parameter	Description
<code>hObj</code>	Handle of MULTIPAGE widget.
<code>Align</code>	Text alignment. See table below.

#### Additional information

Setting the text alignment can have a visual impact only in case the tab width was changed. Otherwise the width is set according to the width of the text.

### 7.2.21.5.1.43 MULTIPAGE\_SetTextColor()

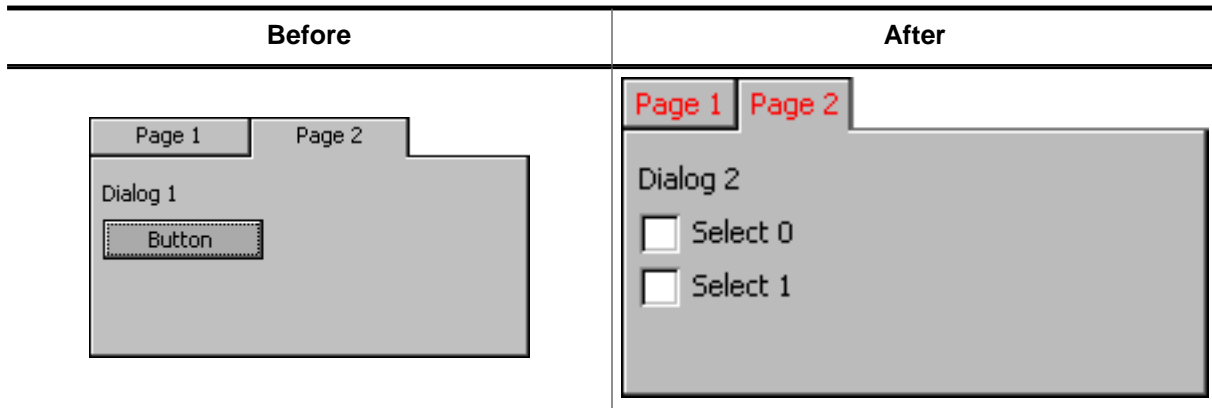

#### Description

Sets the color used to display the text in the tabs of a MULTIPAGE widget.

#### Prototype

```
void MULTIPAGE_SetTextColor(MULTIPAGE_Handle hObj,
                           GUI_COLOR        Color,
                           unsigned        Index);
```

#### Parameters

Parameter	Description
<code>hObj</code>	Handle of MULTIPAGE widget.
<code>Color</code>	<code>Color</code> to be used.
<code>Index</code>	See <i>MULTIPAGE color indexes</i> on page 2081 for a full list of permitted values.

#### Additional information

Setting the text alignment can have a visual impact only in case the tab width was changed. Otherwise the width is set according to the width of the text.

#### 7.2.21.5.1.44 MULTIPAGE\_SetUserData()

##### Description

Prototype explained at the beginning of the chapter as `<WIDGET>_SetUserData()` on page 1166.

## 7.2.21.5.2 Defines

### 7.2.21.5.2.1 MULTIPAGE alignment flags

#### Description

These flags are used by `MULTIPAGE_SetAlign()` and define the tab alignment of a MULTIPAGE widget. Horizontal and vertical flags are OR-combinable.

#### Definition

```
#define MULTIPAGE_ALIGN_LEFT      (0 << 0)
#define MULTIPAGE_ALIGN_RIGHT    (1 << 0)
#define MULTIPAGE_ALIGN_TOP      (0 << 2)
#define MULTIPAGE_ALIGN_BOTTOM  (1 << 2)
```

#### Symbols

Definition	Description
<code>MULTIPAGE_ALIGN_LEFT</code>	Aligns the tabs at the left side.
<code>MULTIPAGE_ALIGN_RIGHT</code>	Aligns the tabs at the right side.
<code>MULTIPAGE_ALIGN_TOP</code>	Aligns the tabs at the top of the widget.
<code>MULTIPAGE_ALIGN_BOTTOM</code>	Aligns the tabs at the bottom of the widget.

### 7.2.21.5.2.2 MULTIPAGE bitmap indexes

#### Description

Bitmap indexes used by the MULTIPAGE widget.

#### Definition

```
#define MULTIPAGE_BI_SELECTED      0
#define MULTIPAGE_BI_UNSELECTED   1
#define MULTIPAGE_BI_DISABLED     2
```

#### Symbols

Definition	Description
<a href="#">MULTIPAGE_BI_SELECTED</a>	Selected state.
<a href="#">MULTIPAGE_BI_UNSELECTED</a>	Unselected state.
<a href="#">MULTIPAGE_BI_DISABLED</a>	Disabled state.



### 7.2.21.5.2.3 MULTIPAGE color indexes

#### Description

Color indexes used by the MULTIPAGE widget.

#### Definition

```
#define MULTIPAGE_CI_DISABLED    0
#define MULTIPAGE_CI_ENABLED    1
```

#### Symbols

Definition	Description
<a href="#">MULTIPAGE_CI_DISABLED</a>	Color for disabled pages.
<a href="#">MULTIPAGE_CI_ENABLED</a>	Color for enabled pages.

#### 7.2.21.5.2.4 MULTIPAGE create flags

##### Description

Create flags used when creating a MULTIPAGE widget or when using the routine `MULTIPAGE_SetRotation()`.

##### Definition

```
#define MULTIPAGE_CF_ROTATE_CW    (1 << 3)
```

##### Symbols

Definition	Description
<code>MULTIPAGE_CF_ROTATE_CW</code>	Arranges the tabs at the vertical side and rotates the tab text by 90 degrees clockwise.

##### Note

When specifying **0** instead of a flag, the widget is displayed in default horizontal mode.

## 7.2.21.6 Example

The `Sample` folder contains the following example which shows how the widget can be used:

- `WIDGET_Multipage.c`

Note that several other examples also make use of this widget and may also be helpful to get familiar with the widget.

### Screenshot of `WIDGET_Multipage.c`

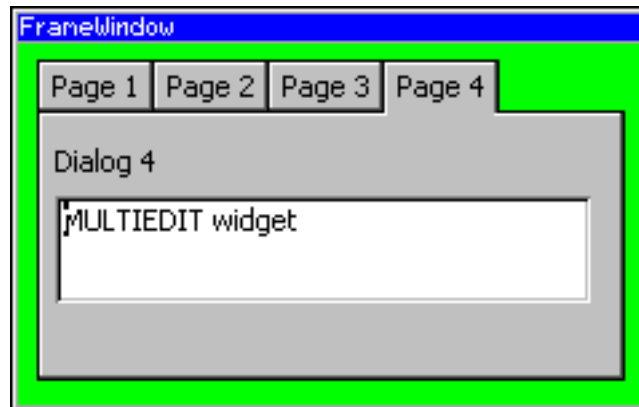

## 7.2.22 PROGBAR: Progress bar widget

PROGBAR widgets are commonly used in applications for visualization; for example, a tank fill-level indicator or an oil-pressure indicator. Example screenshots can be found at the beginning of the chapter and at end of this section.

### Note

All PROGBAR-related routines are in the file(s) `PROGBAR*.c`, `PROGBAR.h`. All identifiers are prefixed `PROGBAR`.

### Skinning...

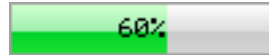

...is available for this widget. The screenshot above shows the widget using the default skin. Details can be found in the chapter *Skinning* on page 2800.

### Note

This widget uses skinning. To change the look it is recommended to use the function `<WIDGET>_SetSkinFlexProps()`. Other functions to change the look might work only with the classic skin.

### 7.2.22.1 Configuration options

Type	Macro	Default	Description
S	<code>PROGBAR_DEFAULT_FONT</code>	<code>GUI_DEFAULT_FONT</code>	Font used.
N	<code>PROGBAR_DEFAULT_BARCOLOR0</code>	<code>0x555555</code> (dark gray)	Left bar color.
N	<code>PROGBAR_DEFAULT_BARCOLOR1</code>	<code>0xAAAAAA</code> (light gray)	Right bar color.
N	<code>PROGBAR_DEFAULT_TEXTCOLOR0</code>	<code>0xFFFFFFFF</code>	Text color, left bar.
N	<code>PROGBAR_DEFAULT_TEXTCOLOR1</code>	<code>0x000000</code>	Text color, right bar.

### 7.2.22.2 Predefined IDs

The following symbols define IDs which may be used to make PROGBAR widgets distinguishable from creation.

```
#define GUI_ID_PROGBAR0    0x210
#define GUI_ID_PROGBAR1    0x211
#define GUI_ID_PROGBAR2    0x212
#define GUI_ID_PROGBAR3    0x213
#define GUI_ID_PROGBAR4    0x214
#define GUI_ID_PROGBAR5    0x215
#define GUI_ID_PROGBAR6    0x216
#define GUI_ID_PROGBAR7    0x217
#define GUI_ID_PROGBAR8    0x218
#define GUI_ID_PROGBAR9    0x219
```

### 7.2.22.3 Notification codes

The following events are sent from a PROGBAR widget to its parent window as part of a `WM_NOTIFY_PARENT` message:

Message	Description
WM_NOTIFICATION_VALUE_CHANGED	Value of the PROGBAR widget has changed.

#### 7.2.22.4 Keyboard reaction

The widget can not gain the input focus and does not react on keyboard input.

## 7.2.22.5 PROGBAR API

The table below lists the available emWin PROGBAR-related routines in alphabetical order. Detailed descriptions of the routines follow.

### Functions

Routine	Description
<code>PROGBAR_Create()</code>	Creates a PROGBAR widget. (Obsolete)
<code>PROGBAR_CreateAsChild()</code>	Creates a PROGBAR widget as a child window. (Obsolete)
<code>PROGBAR_CreateEx()</code>	Creates a PROGBAR widget.
<code>PROGBAR_CreateIndirect()</code>	Creates a PROGBAR widget from resource table entry.
<code>PROGBAR_CreateUser()</code>	Creates a PROGBAR widget using extra bytes as user data.
<code>PROGBAR_GetBarColor()</code>	Returns the color(s) of the PROGBAR widget.
<code>PROGBAR_GetFont()</code>	Returns the font of the PROGBAR widget.
<code>PROGBAR_GetMinMax()</code>	Returns the minimum and maximum values of the PROGBAR.
<code>PROGBAR_GetTextColor()</code>	Returns the text color(s) of the PROGBAR widget.
<code>PROGBAR_GetUserData()</code>	Retrieves the data set with <code>PROGBAR_SetUserData()</code> .
<code>PROGBAR_GetValue()</code>	Returns the current value of the given PROGBAR widget.
<code>PROGBAR_SetBarColor()</code>	Sets the color(s) of the PROGBAR widget.
<code>PROGBAR_SetFont()</code>	Select the font for the text.
<code>PROGBAR_SetMinMax()</code>	Set the minimum and maximum values used for the bar.
<code>PROGBAR_SetText()</code>	Sets the text displayed inside the PROGBAR widget.
<code>PROGBAR_SetTextAlign()</code>	Sets the text alignment.
<code>PROGBAR_SetTextColor()</code>	Sets the text color of the PROGBAR widget.
<code>PROGBAR_SetTextPos()</code>	Sets the text position in pixels.
<code>PROGBAR_SetUserData()</code>	Sets the extra data of a PROGBAR widget.
<code>PROGBAR_SetValue()</code>	Sets the value of the PROGBAR widget.

### Defines

Group of defines	Description
<code>PROGBAR create flags</code>	Create flags used by the PROGBAR widget.

## 7.2.22.5.1 Functions

### 7.2.22.5.1.1 PROGBAR\_Create()

#### Note

This function is **deprecated**, `PROGBAR_CreateEx()` should be used instead.

#### Description

Creates a PROGBAR widget of a specified size at a specified location.

#### Prototype

```
PROGBAR_Handle PROGBAR_Create(int x0,
                              int y0,
                              int xSize,
                              int ySize,
                              int Flags);
```

#### Parameters

Parameter	Description
<code>x0</code>	Leftmost pixel of the PROGBAR widget (in parent coordinates).
<code>y0</code>	Topmost pixel of the PROGBAR widget (in parent coordinates).
<code>xSize</code>	Horizontal size of the PROGBAR widget (in pixels).
<code>ySize</code>	Vertical size of the PROGBAR widget (in pixels).
<code>Flags</code>	Window create flags. Typically <code>WM_CF_SHOW</code> in order to make the widget visible immediately (refer to <i>Window create flags</i> on page 1146 for a list of available parameter values).

#### Return value

Handle of the created PROGBAR widget; 0 if the function fails.

### 7.2.22.5.1.2 PROGBAR\_CreateAsChild()

#### Note

This function is **deprecated**, `PROGBAR_CreateEx()` should be used instead.

#### Description

Creates a PROGBAR widget as a child window.

#### Prototype

```
PROGBAR_Handle PROGBAR_CreateAsChild(int    x0 ,
                                       int    y0 ,
                                       int    xSize ,
                                       int    ySize ,
                                       WM_HWIN hParent ,
                                       int    Id ,
                                       int    Flags);
```

#### Parameters

Parameter	Description
<code>x0</code>	X-position of the PROGBAR widget relative to the parent window.
<code>y0</code>	Y-position of the PROGBAR widget relative to the parent window.
<code>xSize</code>	Horizontal size of the PROGBAR widget (in pixels).
<code>ySize</code>	Vertical size of the PROGBAR widget (in pixels).
<code>hParent</code>	Handle of parent window.
<code>Id</code>	ID to be returned.
<code>Flags</code>	Window create flags (see <i>Window create flags</i> on page 1146).

#### Return value

Handle of the created PROGBAR widget; 0 if the function fails.



### 7.2.22.5.1.3 PROGBAR\_CreateEx()

#### Description

Creates a PROGBAR widget of a specified size at a specified location.

#### Prototype

```
PROGBAR_Handle PROGBAR_CreateEx(int    x0,
                                int    y0,
                                int    xSize,
                                int    ySize,
                                WM_HWIN hParent,
                                int    WinFlags,
                                int    ExFlags,
                                int    Id);
```

#### Parameters

Parameter	Description
<code>x0</code>	Leftmost pixel of the PROGBAR widget (in parent coordinates).
<code>y0</code>	Topmost pixel of the PROGBAR widget (in parent coordinates).
<code>xSize</code>	Horizontal size of the PROGBAR widget (in pixels).
<code>ySize</code>	Vertical size of the PROGBAR widget (in pixels).
<code>hParent</code>	Handle of parent window. If 0, the new PROGBAR widget will be a child of the desktop (top-level window).
<code>WinFlags</code>	Window create flags. Typically <code>WM_CF_SHOW</code> in order to make the widget visible immediately (refer to <i>Window create flags</i> on page 1146 for a list of available parameter values).
<code>ExFlags</code>	See <i>PROGBAR create flags</i> on page 2107.
<code>Id</code>	Window ID of the PROGBAR widget.

#### Return value

Handle of the created PROGBAR widget; 0 if the function fails.

#### 7.2.22.5.1.4 PROGBAR\_CreateIndirect()

##### Description

The prototype of this function is explained at the beginning of this chapter. Details can be found in the description of the function `<WIDGET>_CreateIndirect()` on page 1161. The element `Para` of the according `GUI_WIDGET_CREATE_INFO` structure is not used. The element `Flags` is used according to the parameter `ExFlags` of the function `PROGBAR_CreateEx()`.

### 7.2.22.5.1.5 PROGBAR\_CreateUser()

#### Description

Prototype explained at the beginning of the chapter as `<WIDGET>_CreateUser()` on page 1162. For a detailed description of the parameters the function `PROGBAR_CreateEx()` can be referred to.

### 7.2.22.5.1.6 PROGBAR\_GetBarColor()

#### Description

Returns the color(s) of the PROGBAR widget.

#### Prototype

```
GUI_COLOR PROGBAR_GetBarColor(PROGBAR_Handle hObj,  
                               unsigned int   Index);
```

#### Parameters

Parameter	Description
<a href="#">hObj</a>	Handle of PROGBAR widget.
<a href="#">Index</a>	See table below. Other values are not permitted.

Permitted values for parameter <a href="#">Index</a>	
0	Left/lower portion of the PROGBAR widget.
1	Right/upper portion of the PROGBAR widget.

#### Return value

The color(s) of the PROGBAR widget.

### 7.2.22.5.1.7 PROGBAR\_GetFont()

#### Description

Returns the font of the PROGBAR widget.

#### Prototype

```
GUI_FONT *PROGBAR_GetFont(PROGBAR_Handle hObj);
```

#### Parameters

Parameter	Description
<a href="#">hObj</a>	Handle of PROGBAR widget.

#### Return value

The font of the PROGBAR widget.

### 7.2.22.5.1.8 PROGBAR\_GetMinMax()

#### Description

Copies the minimum value and maximum value of the given PROGBAR widget to the given integer pointers.

#### Prototype

```
void PROGBAR_GetMinMax(PROGBAR_Handle hObj,  
                       int * pMin,  
                       int * pMax);
```

#### Parameters

Parameter	Description
<a href="#">hObj</a>	Handle of PROGBAR widget.
<a href="#">pMin</a>	Minimum value (Range: $-16383 < \text{Min} \leq 16383$ ).
<a href="#">pMax</a>	Maximum value (Range: $-16383 < \text{Max} \leq 16383$ ).

### 7.2.22.5.1.9 PROGBAR\_GetTextColor()

#### Description

Returns the text color(s) of the PROGBAR widget.

#### Prototype

```
GUI_COLOR PROGBAR_GetTextColor(PROGBAR_Handle hObj,  
                                unsigned int   Index);
```

#### Parameters

Parameter	Description
<a href="#">hObj</a>	Handle of PROGBAR widget.
<a href="#">Index</a>	See table below. Other values are not permitted.

Permitted values for parameter <a href="#">Index</a>	
0	Left/lower portion of the text.
1	Right/upper portion of the text.

#### Return value

The text color(s) of the PROGBAR widget.

### 7.2.22.5.1.10 PROGBAR\_GetUserData()

#### Description

Prototype explained at the beginning of the chapter as `<WIDGET>_GetUserData()` on page 1165.



### 7.2.22.5.1.11 PROGBAR\_GetValue()

#### Description

Returns the current value of the given PROGBAR widget.

#### Prototype

```
int PROGBAR_GetValue(PROGBAR_Handle hObj);
```

#### Parameters

Parameter	Description
<a href="#">hObj</a>	Handle of PROGBAR widget.

#### Return value

Current value of the PROGBAR widget.

### 7.2.22.5.1.12 PROGBAR\_SetBarColor()

#### Description

Sets the color(s) of the PROGBAR widget.

#### Prototype

```
void PROGBAR_SetBarColor(PROGBAR_Handle hObj,
                        unsigned int   Index,
                        GUI_COLOR      color);
```

#### Parameters

Parameter	Description
<a href="#">hObj</a>	Handle of PROGBAR widget.
<a href="#">Index</a>	See table below. Other values are not permitted.
<a href="#">Color</a>	<a href="#">Color</a> to set (24-bit RGB value).

Permitted values for parameter <a href="#">Index</a>	
0	Left/lower portion of the PROGBAR widget.
1	Right/upper portion of the PROGBAR widget.

### 7.2.22.5.1.13 PROGBAR\_SetFont()

#### Description

Selects the font for the text display inside the PROGBAR widget.

#### Prototype

```
void PROGBAR_SetFont(      PROGBAR_Handle  hObj,  
                          const GUI_FONT   * pfont);
```

#### Parameters

Parameter	Description
<a href="#">hObj</a>	Handle of PROGBAR widget.
<a href="#">Index</a>	See table below. Other values are not permitted.
<a href="#">Color</a>	<a href="#">Color</a> to set (24-bit RGB value).

#### Additional information

If this function is not called, the default font for PROGBAR widgets (the GUI default font) will be used. However, the default font of the PROGBAR widget may be changed in the `GUIConf.h` file. Simply define the default font as follows (example):

```
#define PROGBAR_DEFAULT_FONT &GUI_Font13_ASCII
```

### 7.2.22.5.1.14 PROGBAR\_SetMinMax()

#### Description

Sets the minimum and maximum values used for the PROGBAR widget.

#### Prototype

```
void PROGBAR_SetMinMax(PROGBAR_Handle hObj,  
                        int           Min,  
                        int           Max);
```

#### Parameters

Parameter	Description
<a href="#">hObj</a>	Handle of PROGBAR widget.
<a href="#">Min</a>	Minimum value (Range: $-16383 < \text{Min} \leq 16383$ ).
<a href="#">Max</a>	Maximum value (Range: $-16383 < \text{Max} \leq 16383$ ).

#### Additional information

If this function is not called, the default values of [Min](#) = 0, [Max](#) = 100 will be used.

### 7.2.22.5.1.15 PROGBAR\_SetText()

#### Description

Sets the text displayed inside the PROGBAR widget.

#### Prototype

```
void PROGBAR_SetText(      PROGBAR_Handle  hObj,  
                          const char      * s);
```

#### Parameters

Parameter	Description
<code>hObj</code>	Handle of PROGBAR widget.
<code>s</code>	Text to display. A <code>NULL</code> pointer is permitted; in this case a percentage value will be displayed.

#### Additional information

If this function is not called, a percentage value will be displayed as the default. If you do not want to display any text at all, you should set an empty string.

### 7.2.22.5.1.16 PROGBAR\_SetTextAlign()

#### Description

Sets the text alignment.

#### Prototype

```
void PROGBAR_SetTextAlign(PROGBAR_Handle hObj,  
                           int           Align);
```

#### Parameters

Parameter	Description
<code>hObj</code>	Handle of PROGBAR widget.
<code>Align</code>	See <i>Text alignment flags</i> on page 286. <b>Only horizontal flags are applicable!</b>

#### Additional information

If this function is not called, the default behavior is to display the text centered.

### 7.2.22.5.1.17 PROGBAR\_SetTextColor()

#### Description

Sets the text color of the PROGBAR widget.

#### Prototype

```
void PROGBAR_SetTextColor(PROGBAR_Handle hObj,
                          unsigned int   Index,
                          GUI_COLOR      color);
```

#### Parameters

Parameter	Description
<a href="#">hObj</a>	Handle of PROGBAR widget.
<a href="#">Index</a>	See table below. Other values are not permitted.
<a href="#">Color</a>	<a href="#">Color</a> to set (24-bit RGB value).

Permitted values for parameter <a href="#">Index</a>	
0	Left portion of the text.
1	Right portion of the text.

### 7.2.22.5.1.18 PROGBAR\_SetTextPos()

#### Description

Sets the text position in pixels.

#### Prototype

```
void PROGBAR_SetTextPos(PROGBAR_Handle hObj,  
                        int             XOff,  
                        int             YOff);
```

#### Parameters

Parameter	Description
<code>hObj</code>	Handle of PROGBAR widget.
<code>XOff</code>	Number of pixels to move text in horizontal direction. Positive number will move text to the right.
<code>YOff</code>	Number of pixels to move text in vertical direction. Positive number will move text down.

#### Additional information

The values move the text the specified number of pixels within the widget. Normally, the default of (0,0) should be sufficient.



### 7.2.22.5.1.19 PROGBAR\_SetUserData()

#### Description

Prototype explained at the beginning of the chapter as `<WIDGET>_SetUserData()` on page 1166.

### 7.2.22.5.1.20 PROGBAR\_SetValue()

#### Description

Sets the value of the PROGBAR widget.

#### Prototype

```
void PROGBAR_SetValue(PROGBAR_Handle hObj,  
                      int v);
```

#### Parameters

Parameter	Description
hObj	Handle of PROGBAR widget.
v	Value to set.

#### Additional information

The bar indicator will be calculated with regard to the max/min values. If a percentage is automatically displayed, the percentage will also be calculated using the given min/max values as follows:

$$p = 100\% * (v - \text{Min}) / (\text{Max} - \text{Min})$$

The default value after creation of the widget is 0.

## 7.2.22.5.2 Defines

### 7.2.22.5.2.1 PROGBAR create flags

#### Description

Create flags used for the PROGBAR widget. These flags are specified when creating the widget with `PROGBAR_CreateEx()`.

#### Definition

```
#define PROGBAR_CF_HORIZONTAL (0 << 0)
#define PROGBAR_CF_VERTICAL (1 << 0)
```

#### Symbols

Definition	Description
<code>PROGBAR_CF_VERTICAL</code>	A vertical PROGBAR widget will be created. Vertical PROGBAR widgets do not show any text.
<code>PROGBAR_CF_HORIZONTAL</code>	A horizontal PROGBAR widget will be created (default).

## 7.2.22.6 Examples

The `Sample` folder contains the following examples which show how the widget can be used:

- `WIDGET_SimpleProgbar.c`
- `WIDGET_Progbar.c`

Note that several other examples also make use of this widget and may also be helpful to get familiar with the widget.

### Screenshot of `WIDGET_SimpleProgbar.c`

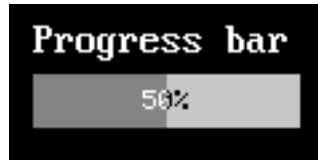

### Screenshot of `WIDGET_Progbar.c`

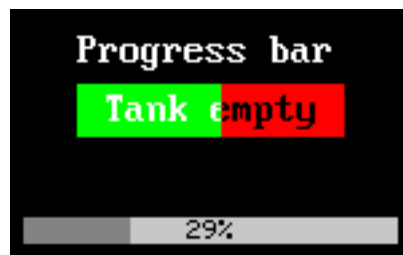

## 7.2.23 QRCODE: QR code widget

The QRCODE widget is used for displaying QR codes. The widget draws a QR code with the given parameters and also adds a white frame around the code which is necessary for scanning.

### Note

All QRCODE-related routines are located in the file(s) `QRCODE.c`, `QRCODE.h`.



### 7.2.23.1 Configuration options

Type	Macro	Default	Description
N	QRCODE_COLOR_DEFAULT	GUI_WHITE	Default color to draw the bright pixels.
N	QRCODE_BKCOLOR_DEFAULT	GUI_BLACK	Default default color to draw the dark pixels.

### 7.2.23.2 Predefined IDs

The following symbols define IDs which may be used to make QRCODE widgets distinguishable from creation.

```
#define GUI_ID_QRCODE0    0x350
#define GUI_ID_QRCODE1    0x351
#define GUI_ID_QRCODE2    0x352
#define GUI_ID_QRCODE3    0x353
#define GUI_ID_QRCODE4    0x354
#define GUI_ID_QRCODE5    0x355
#define GUI_ID_QRCODE6    0x356
#define GUI_ID_QRCODE7    0x357
#define GUI_ID_QRCODE8    0x358
#define GUI_ID_QRCODE9    0x359
```

### 7.2.23.3 Keyboard reaction

The widget can not gain the input focus and does not react on keyboard input.

## 7.2.23.4 QR CODE API

The table below lists the available emWin QR CODE-related routines in alphabetical order. Detailed descriptions of the routines follow.

### Functions

Routine	Description
<a href="#">QR_CODE_CreateIndirect()</a>	Creates a QR CODE widget from a resource table entry.
<a href="#">QR_CODE_CreateUser()</a>	Creates a QR CODE widget.
<a href="#">QR_CODE_SetEccLevel()</a>	Sets the error correction level of a QR CODE widget.
<a href="#">QR_CODE_SetVersion()</a>	Sets the version of the QR code.
<a href="#">QR_CODE_SetPixelSize()</a>	Sets the size of one pixel in the QR CODE widget.
<a href="#">QR_CODE_SetText()</a>	Sets the text to be used to draw the QR CODE widget.
<a href="#">QR_CODE_SetWiFiText()</a>	Sets the text of a QR CODE widget told hold WiFi login data.

### Defines

Group of defines	Description
<a href="#">QR_CODE_WiFi_encryption_types</a>	Macros for WiFi password encryption types.

## 7.2.23.4.1 Functions

### 7.2.23.4.1.1 QRCODE\_CreateIndirect()

#### Description

The prototype of this function is explained at the beginning of this chapter. Details can be found in the description of the function `<WIDGET>_CreateIndirect()` on page 1161. The elements `Flags` and `Para` of the resource passed as parameter are not used.

### 7.2.23.4.1.2 QRCODE\_CreateUser()

#### Description

Creates a QRCODE widget.

#### Prototype

```
QRCODE_Handle QRCODE_CreateUser(    int        x0,
                                     int        y0,
                                     int        xSize,
                                     int        ySize,
                                     WM_HWIN   hParent,
                                     U32       WinFlags,
                                     int        ExFlags,
                                     int        Id,
                                     const char * pText,
                                     int        PixelSize,
                                     int        EccLevel,
                                     int        Version,
                                     int        NumExtraBytes);
```

#### Parameters

Parameter	Description
<code>x0</code>	Leftmost pixel of the QRCODE widget (in parent coordinates).
<code>y0</code>	Topmost pixel of the QRCODE widget (in parent coordinates).
<code>xSize</code>	Horizontal size of the QRCODE widget (in pixels).
<code>ySize</code>	Vertical size of the QRCODE widget (in pixels).
<code>hParent</code>	Parent window of the QRCODE widget.
<code>WinFlags</code>	Window create flags. Typically <code>WM_CF_SHOW</code> in order to make the widget visible immediately (refer to <i>Window create flags</i> on page 1146 for a list of available parameter values).
<code>ExFlags</code>	Not used yet, reserved for future use.
<code>Id</code>	ID of the QRCODE widget.
<code>pText</code>	UTF-8 text to be used for the QR-code.
<code>PixelSize</code>	Size in pixels of one 'Module'.
<code>EccLevel</code>	Error correction level to be used. See full list of available values under <i>ECC levels for QR codes</i> on page 443.
<code>NumModules</code>	Desired size in modules of the QR-code. If set to 0 (recommended) the size will be calculated automatically. Must be between 1 and 40. If it is less than required for the given text with the given <code>EccLevel</code> , the function fails.
<code>NumExtraBytes</code>	Number of extra bytes to be allocated.

#### Return value

Handle of the QRCODE widget.



### 7.2.23.4.1.3 QRCODE\_SetEccLevel()

#### Description

Sets the error correction level of a QRCODE widget.

#### Prototype

```
void QRCODE_SetEccLevel(QRCODE_Handle hObj,  
                        int EccLevel);
```

#### Parameters

Parameter	Description
<code>hObj</code>	Handle of QRCODE widget.
<code>EccLevel</code>	Error correction level to be used. See full list of available values under <i>ECC levels for QR codes</i> on page 443.

#### 7.2.23.4.1.4 QRCODE\_SetVersion()

##### Description

Sets the version of the QR code. The version indicates the size of the total code.

##### Prototype

```
void QRCODE_SetVersion(QRCODE_Handle hObj,  
                       int           Version);
```

##### Parameters

Parameter	Description
<code>hObj</code>	Handle of QRCODE widget.
<code>Version</code>	Should be between 1 and 40. If set to 0, the size will be calculated automatically.

### 7.2.23.4.1.5 QRCODE\_SetPixelSize()

#### Description

Sets the size of one pixel in the QRCODE widget.

#### Prototype

```
void QRCODE_SetPixelSize(QRCODE_Handle hObj,  
                          int          PixelSize);
```

#### Parameters

Parameter	Description
<code>hObj</code>	Handle of QRCODE widget.
<code>PixelSize</code>	Size of one pixel to be used.

### 7.2.23.4.1.6 QRCODE\_SetText()

#### Description

Sets the text to be used to draw the QRCODE widget.

#### Prototype

```
void QRCODE_SetText(      QRCODE_Handle  hObj,  
                        const char      * pText);
```

#### Parameters

Parameter	Description
<code>hObj</code>	Handle of QRCODE widget.
<code>pText</code>	Text to be used for the widget.

### 7.2.23.4.1.7 QRCODE\_SetWiFiText()

#### Description

Sets the text of a QRCODE widget told hold WiFi login data. When scanning the QR code with a smartphone, the phone will try to log into the specified WiFi network.

#### Prototype

```
void QRCODE_SetWiFiText(    QRCODE_Handle  hObj,
                           const char      * pSSID,
                           U8              Encryption,
                           const char      * pPassword,
                           U8              Hidden);
```

#### Parameters

Parameter	Description
<a href="#">hObj</a>	Handle of QRCODE widget.
<a href="#">pSSID</a>	SSID of the network.
<a href="#">Encryption</a>	See <i>QRCODE WiFi encryption types</i> on page 2118.
<a href="#">pPassword</a>	Password of the network.
<a href="#">Hidden</a>	0 if the network is not hidden, 1 if it is hidden.

## 7.2.23.4.2 Defines

### 7.2.23.4.2.1 QRCODE WiFi encryption types

#### Description

These macros are to be used for the [Encryption](#) parameter of `QRCODE_SetWiFiText()`.

#### Definition

```
#define QRCODE_WIFI_WPA    0
#define QRCODE_WIFI_WEP    1
```

#### Symbols

Definition	Description
<a href="#">QRCODE_WIFI_WPA</a>	If the WiFi password is WPA encrypted.
<a href="#">QRCODE_WIFI_WEP</a>	If the WiFi password is WEP encrypted.





## 7.2.24 RADIO: Radio button widget

Radio buttons, like check boxes, are used for selecting choices. A dot appears when a RADIO button is turned on or selected. The difference from check boxes is that the user can only select one RADIO button at a time. When a button is selected, the other buttons in the widget are turned off, as shown to the right. One RADIO button widget may contain any number of buttons, which are always arranged vertically.

### Note

All RADIO-related routines are located in the file(s) `RADIO*.c`, `RADIO.h`. All identifiers are prefixed `RADIO`.

The table below shows the classic appearances of a RADIO widget. The default appearance of the widget uses the newer skin, as seen below the table.

	Enabled	Disabled
<b>Selected</b>	 Radio button	 Radio button
<b>Unselected</b>	 Radio button	 Radio button

### Skinning...

- Option 1
- Option 2
- Option 3

...is available for this widget. The screenshot above shows the widget using the default skin. Details can be found in the chapter *Skinning* on page 2800.

### Note

This widget uses skinning. To change the look it is recommended to use the function `<WIDGET>_SetSkinFlexProps()`. Other functions to change the look might work only with the classic skin.

### 7.2.24.1 Configuration options

Type	Macro	Default	Description
S	<code>RADIO_IMAGE0_DEFAULT</code>	(see table above)	Default outer image used to show a disabled RADIO button.
S	<code>RADIO_IMAGE1_DEFAULT</code>	(see table above)	Default outer image used to show a enabled RADIO button.
S	<code>RADIO_IMAGE_CHECK_DEFAULT</code>	(see table above)	Default inner image used to mark the selected item.
N	<code>RADIO_FONT_DEFAULT</code>	<code>&amp;GUI_Font13_1</code>	Default font used to render the text of the RADIO widget.
N	<code>RADIO_DEFAULT_TEXT_COLOR</code>	<code>GUI_BLACK</code>	Default text color of RADIO widget.
N	<code>RADIO_DEFAULT_BKCOLOR</code>	<code>0xC0C0C0</code>	Default background color of RADIO buttons if no transparency is used.
N	<code>RADIO_FOCUSCOLOR_DEFAULT</code>	<code>GUI_BLACK</code>	Default color for rendering the focus rectangle.

## 7.2.24.2 Predefined IDs

The following symbols define IDs which may be used to make RADIO widgets distinguishable from creation.

```
#define GUI_ID_RADIO0    0x150
#define GUI_ID_RADIO1    0x151
#define GUI_ID_RADIO2    0x152
#define GUI_ID_RADIO3    0x153
#define GUI_ID_RADIO4    0x154
#define GUI_ID_RADIO5    0x155
#define GUI_ID_RADIO6    0x156
#define GUI_ID_RADIO7    0x157
#define GUI_ID_RADIO8    0x158
#define GUI_ID_RADIO9    0x159
```

## 7.2.24.3 Notification codes

The following events are sent from a RADIO widget to its parent window as part of a WM\_NOTIFY\_PARENT message:

Message	Description
WM_NOTIFICATION_CLICKED	RADIO button has been clicked.
WM_NOTIFICATION_RELEASED	RADIO button has been released.
WM_NOTIFICATION_MOVED_OUT	RADIO button has been clicked and pointer has been moved out of the button without releasing.
WM_NOTIFICATION_VALUE_CHANGED	Value (selection) of the RADIO widget has changed.

## 7.2.24.4 Keyboard reaction

The widget reacts to the following keys if it has the input focus:

Key	Reaction
GUI_KEY_RIGHT	Increments the selection by 1.
GUI_KEY_DOWN	Increments the selection by 1.
GUI_KEY_LEFT	Decrements the selection by 1.
GUI_KEY_UP	Decrements the selection by 1.



## 7.2.24.5 RADIO API

The table below lists the available emWin RADIO-related routines in alphabetical order. Detailed descriptions of the routines follow.

### Functions

Routine	Description
<code>RADIO_Create()</code>	Creates a RADIO widget. (Obsolete)
<code>RADIO_CreateEx()</code>	Creates a RADIO widget.
<code>RADIO_CreateIndirect()</code>	Creates a RADIO widget from resource table entry.
<code>RADIO_CreateUser()</code>	Creates a RADIO widget using extra bytes as user data.
<code>RADIO_Dec()</code>	Decrements the selection by 1.
<code>RADIO_GetBkColor()</code>	Returns the background color of the RADIO widget.
<code>RADIO_GetDefaultFont()</code>	Returns the default font used to display the optional text next to new RADIO buttons.
<code>RADIO_GetDefaultTextColor()</code>	Returns the default text color used to display the optional text next to new RADIO buttons.
<code>RADIO_GetFocusColor()</code>	Returns the color used to render the focus rectangle of the RADIO button.
<code>RADIO_GetFont()</code>	Returns the font set for this widget.
<code>RADIO_GetImage()</code>	Returns a pointer to the set image of a RADIO.
<code>RADIO_GetNumItems()</code>	Returns the number of items in a RADIO widget.
<code>RADIO_GetSpacing()</code>	Returns the vertical spacing between the items.
<code>RADIO_GetText()</code>	Returns the optional text of the given RADIO widget.
<code>RADIO_GetTextColor()</code>	Returns the text color of the RADIO widget.
<code>RADIO_GetUserData()</code>	Retrieves the data set with <code>RADIO_SetUserData()</code> .
<code>RADIO_GetValue()</code>	Returns the currently selected button.
<code>RADIO_Inc()</code>	Increments the selection by a value of 1.
<code>RADIO_SetBkColor()</code>	Sets the background color of the RADIO widget.
<code>RADIO_SetDefaultFocusColor()</code>	Sets the default focus rectangle color for new RADIO buttons.
<code>RADIO_SetDefaultFont()</code>	Sets the default font used to display the optional text next to new RADIO buttons.
<code>RADIO_SetDefaultImage()</code>	Sets the images used to draw new RADIO buttons.
<code>RADIO_SetDefaultTextColor()</code>	Sets the default text color used to display the optional text next to new RADIO buttons.
<code>RADIO_SetFocusColor()</code>	Sets the color used to render the focus rectangle of the RADIO button.
<code>RADIO_SetFont()</code>	Sets the font used to display the optional text next to the RADIO buttons.
<code>RADIO_SetGroupId()</code>	Sets the group ID of the RADIO widget.
<code>RADIO_SetImage()</code>	Sets the images used to draw the RADIO button.
<code>RADIO_SetSpacing()</code>	Sets the vertical spacing between the items.
<code>RADIO_SetText()</code>	Sets the text.
<code>RADIO_SetTextColor()</code>	Sets the text color used to show the optional text beside the RADIO buttons.

Routine	Description
<code>RADIO_SetUserData()</code>	Sets the extra data of a RADIO widget.
<code>RADIO_SetValue()</code>	Sets the current button selection.

## Defines

Group of defines	Description
<code>RADIO bitmap indexes</code>	Bitmap indexes used for setting the bitmaps of a RADIO widget.

## 7.2.24.5.1 Functions

### 7.2.24.5.1.1 RADIO\_Create()

#### Note

This function is **deprecated**, `RADIO_CreateEx()` should be used instead.

#### Description

Creates a RADIO widget of a specified size at a specified location.

#### Prototype

```
RADIO_Handle RADIO_Create(int    x0,
                          int    y0,
                          int    xSize,
                          int    ySize,
                          WM_HWIN hParent,
                          int    Id,
                          int    Flags,
                          unsigned Para);
```

#### Parameters

Parameter	Description
<code>x0</code>	Leftmost pixel of the RADIO widget (in parent coordinates).
<code>y0</code>	Topmost pixel of the RADIO widget (in parent coordinates).
<code>xSize</code>	Horizontal size of the RADIO widget (in pixels).
<code>ySize</code>	Vertical size of the RADIO widget (in pixels).
<code>hParent</code>	Handle of parent window.
<code>Id</code>	ID to be returned.
<code>Flags</code>	Window create flags. Typically <code>WM_CF_SHOW</code> in order to make the widget visible immediately (refer to <i>Window create flags</i> on page 1146 for a list of available parameter values).
<code>Para</code>	Number of buttons in the group.
<code>v</code>	Value to set.

#### Return value

Handle of the created RADIO widget; 0 if the function fails.

### 7.2.24.5.1.2 RADIO\_CreateEx()

#### Description

Creates a RADIO widget of a specified size at a specified location.

#### Prototype

```
RADIO_Handle RADIO_CreateEx(int    x0,
                             int    y0,
                             int    xSize,
                             int    ySize,
                             WM_HWIN hParent,
                             int    WinFlags,
                             int    ExFlags,
                             int    Id,
                             int    NumItems,
                             int    Spacing);
```

#### Parameters

Parameter	Description
<code>x0</code>	Leftmost pixel of the widget (in parent coordinates).
<code>y0</code>	Topmost pixel of the widget (in parent coordinates).
<code>xSize</code>	Horizontal size of the widget (in pixels).
<code>ySize</code>	Vertical size of the widget (in pixels).
<code>hParent</code>	Handle of parent window. If 0, the new RADIO widget will be a child of the desktop (top-level window).
<code>WinFlags</code>	Window create flags. Typically <code>WM_CF_SHOW</code> in order to make the widget visible immediately (refer to <i>Window create flags</i> on page 1146 for a list of available parameter values).
<code>ExFlags</code>	Not used, reserved for future use.
<code>Id</code>	Window ID of the widget.
<code>NumItems</code>	Number of items contained by the RADIO widget. (default is 2)
<code>Spacing</code>	Number of vertical pixels used for each item of the RADIO widget.

#### Return value

Handle of the created RADIO widget; 0 if the function fails.

#### Additional information

If creating a RADIO widget make sure, that the given `ySize` is enough to show all items. The value should be at least `NumItems * Spacing`. If the given value of `NumItems` is  $\leq 0$  a default value of 2 is used.

### 7.2.24.5.1.3 RADIO\_CreateIndirect()

#### Description

The prototype of this function is explained at the beginning of this chapter. For details the function `<WIDGET>_CreateIndirect()` on page 1161 should be referred to. The element Flags of the according `GUI_WIDGET_CREATE_INFO` structure is not used. The following table shows the use of the element `Para`:

Bits	Description
0 - 7	Number of items of the RADIO widget. If 0, a default value of 2 items is used.
8 - 15	Number of vertical pixels used for each item. If 0 the height of the default image is used.
16 - 23	Not used, reserved for future use.
24 - 31	Not used, reserved for future use.

#### 7.2.24.5.1.4 RADIO\_CreateUser()

##### Description

Prototype explained at the beginning of the chapter as `<WIDGET>_CreateUser()` on page 1162. For a detailed description of the parameters the function `RADIO_CreateEx()` can be referred to.

### 7.2.24.5.1.5 RADIO\_Dec()

Before	After
<input type="radio"/> Red <input checked="" type="radio"/> Green <input type="radio"/> Blue	<input checked="" type="radio"/> Red <input type="radio"/> Green <input type="radio"/> Blue

#### Description

Decrements the selection by 1.

#### Prototype

```
void RADIO_Dec(RADIO_Handle hObj);
```

#### Parameters

Parameter	Description
<code>hObj</code>	Handle of RADIO widget.

#### Additional information

Note that the numbering of the buttons always starts from the top with a value of 0; therefore, decrementing the selection will actually move the selection one button up.

### 7.2.24.5.1.6 RADIO\_GetBkColor()

#### Description

Returns the background color of the RADIO widget.

#### Prototype

```
GUI_COLOR RADIO_GetBkColor(RADIO_Handle hObj);
```

#### Parameters

Parameter	Description
<a href="#">hObj</a>	Handle of RADIO widget.

#### Return value

The background color of the widget.



### 7.2.24.5.1.7 RADIO\_GetDefaultFont()

#### Description

Returns the default font used to display the optional text next to new RADIO buttons.

#### Prototype

```
GUI_FONT *RADIO_GetDefaultFont(void);
```

#### Return value

Default font used to display the optional text next to the RADIO buttons.

#### Additional information

For information about how to add text to a RADIO widget, refer to `RADIO_SetText()`.

### 7.2.24.5.1.8 RADIO\_GetDefaultTextColor()

#### Description

Returns the default text color used to display the optional text next to new RADIO buttons.

#### Prototype

```
GUI_COLOR RADIO_GetDefaultTextColor(void);
```

#### Return value

Default text color used to display the optional text next to new RADIO buttons.

#### Additional information

For information about how to add text to a RADIO widget, refer to `RADIO_SetText()`.

### 7.2.24.5.1.9 RADIO\_GetFocusColor()

#### Description

Returns the color used to render the focus rectangle of the RADIO button.

#### Prototype

```
GUI_COLOR RADIO_GetFocusColor(RADIO_Handle hObj);
```

#### Parameters

Parameter	Description
<a href="#">hObj</a>	Handle of RADIO widget.

#### Return value

The color of the focus rectangle.

### 7.2.24.5.1.10 RADIO\_GetFont()

#### Description

Returns the font set for this widget.

#### Prototype

```
GUI_FONT *RADIO_GetFont(RADIO_Handle hObj);
```

#### Parameters

Parameter	Description
<a href="#">hObj</a>	Handle of RADIO widget.

#### Return value

A pointer to the font of the widget.

### 7.2.24.5.1.11 RADIO\_GetImage()

#### Description

Returns a pointer to the set image of a RADIO.

#### Prototype

```
GUI_BITMAP *RADIO_GetImage(RADIO_Handle hObj,  
                           unsigned int Index);
```

#### Parameters

Parameter	Description
<a href="#">hObj</a>	Handle to RADIO widget.
<a href="#">Index</a>	See <i>RADIO bitmap indexes</i> on page 2155 for a full list of permitted values.

#### Return value

Pointer to a GUI\_BITMAP structure of the set image.

### 7.2.24.5.1.12 RADIO\_GetNumItems()

#### Description

Returns the number of items in a RADIO widget.

#### Prototype

```
int RADIO_GetNumItems(RADIO_Handle hObj);
```

#### Parameters

Parameter	Description
<a href="#">hObj</a>	Handle of RADIO widget.

#### Return value

Number of items in the RADIO widget.

### 7.2.24.5.1.13 RADIO\_GetSpacing()

#### Description

Returns the vertical spacing between the items.

#### Prototype

```
U16 RADIO_GetSpacing(RADIO_Handle hObj);
```

#### Parameters

Parameter	Description
<a href="#">hObj</a>	Handle of RADIO widget.

#### Return value

Vertical spacing between the items.

### 7.2.24.5.1.14 RADIO\_GetText()

#### Description

Returns the optional text of the given RADIO widget.

#### Prototype

```
int RADIO_GetText(RADIO_Handle hObj,  
                 unsigned Index,  
                 char * pBuffer,  
                 int MaxLen);
```

#### Parameters

Parameter	Description
<a href="#">hObj</a>	Handle of RADIO widget.
<a href="#">Index</a>	<a href="#">Index</a> of the desired item.
<a href="#">pBuffer</a>	Pointer to buffer to which the text will be copied.
<a href="#">MaxLen</a>	Buffer size in bytes.

#### Return value

Length of the text copied into the buffer.

#### Additional information

If the desired item of the RADIO widget contains no text the function returns 0 and the buffer remains unchanged.



### 7.2.24.5.1.15 RADIO\_GetTextColor()

#### Description

Returns the text color of the RADIO widget.

#### Prototype

```
GUI_COLOR RADIO_GetTextColor(RADIO_Handle hObj);
```

#### Parameters

Parameter	Description
<a href="#">hObj</a>	Handle of RADIO widget.

#### Return value

The text color of the widget.

### 7.2.24.5.1.16 RADIO\_GetUserData()

#### Description

Prototype explained at the beginning of the chapter as `<WIDGET>_GetUserData()` on page 1165.

### 7.2.24.5.1.17 RADIO\_GetValue()

#### Description

Returns the currently selected button.

#### Prototype

```
int RADIO_GetValue(RADIO_Handle hObj);
```

#### Parameters

Parameter	Description
<code>hObj</code>	Handle of RADIO widget.

#### Return value

The value of the currently selected button. If no button is selected (in case of using a RADIO button group) the return value is -1.

#### Additional information

For information about how to use groups of RADIO buttons, refer to `RADIO_SetGroupId()`.

### 7.2.24.5.1.18 RADIO\_Inc()

Before	After
<input checked="" type="radio"/> Red <input type="radio"/> Green <input type="radio"/> Blue	<input type="radio"/> Red <input checked="" type="radio"/> Green <input type="radio"/> Blue

#### Description

Increments the selection by a value of 1.

#### Prototype

```
void RADIO_Inc(RADIO_Handle hObj);
```

#### Parameters

Parameter	Description
<code>hObj</code>	Handle of RADIO widget.

#### Additional information

Note that the numbering of the buttons always starts from the top with a value of 0; therefore, incrementing the selection will actually move the selection one button down.

### 7.2.24.5.1.19 RADIO\_SetBkColor()

Before	After
	

#### Description

Sets the background color of the RADIO widget.

#### Prototype

```
void RADIO_SetBkColor(RADIO_Handle hObj,
                     GUI_COLOR Color);
```

#### Parameters

Parameter	Description
<code>hObj</code>	Handle of RADIO widget.
<code>Color</code>	<code>Color</code> to be used for the background. (range 0x000000 and 0xFFFFFFFF or a valid color define) <code>GUI_INVALID_COLOR</code> to make background transparent

#### Additional information

The background of this widget can either be filled with any available color or transparent. If a valid RGB color is specified, the background is filled with the color, otherwise the background (typically the content of the parent window) is visible. If the background is transparent, the widget is treated as transparent window, otherwise as non-transparent window. Note that using a background color allows more efficient (faster) rendering. If skinning is active this function should not be used.

### 7.2.24.5.1.20 RADIO\_SetDefaultFocusColor()

#### Description

Sets the default focus rectangle color for new RADIO buttons.

#### Prototype

```
GUI_COLOR RADIO_SetDefaultFocusColor(GUI_COLOR Color);
```

#### Parameters

Parameter	Description
<code>hObj</code>	Handle of RADIO widget.
<code>Color</code>	<code>Color</code> to be used for the background. (range 0x000000 and 0xFFFFFFFF or a valid color define) <code>GUI_INVALID_COLOR</code> to make background transparent

#### Return value

Previous default focus rectangle color.

#### Additional information

For more information, refer to `RADIO_SetFocusColor()`.

### 7.2.24.5.1.21 RADIO\_SetDefaultFont()

#### Description

Sets the default font used to display the optional text next to new RADIO buttons.

#### Prototype

```
void RADIO_SetDefaultFont(const GUI_FONT * pFont);
```

#### Parameters

Parameter	Description
<code>pFont</code>	Pointer to GUI_FONT structure used to show the text of new RADIO widgets.

#### Additional information

For information about how to add text to a RADIO widget, refer to `RADIO_SetText()`.

### 7.2.24.5.1.22 RADIO\_SetDefaultImage()

#### Description

Sets the images used to draw new RADIO buttons.

#### Prototype

```
void RADIO_SetDefaultImage(const GUI_BITMAP * pBitmap,  
                           unsigned int   Index);
```

#### Parameters

Parameter	Description
<a href="#">pBitmap</a>	Pointer to the bitmap.
<a href="#">Index</a>	See <i>RADIO bitmap indexes</i> on page 2155 for a full list of permitted values.

#### Additional information

Two images are used to display a RADIO button. One image is used to draw the outer frame used to display a unselected RADIO button. In dependence of the current state it will be the bitmap referenced by `RADIO_BI_ACTIVE` (default) or by `RADIO_BI_ACTIVE`. The second image (referenced by `RADIO_BI_CHECK`) is used to mark the currently selected button.



### 7.2.24.5.1.23 RADIO\_SetDefaultTextColor()

#### Description

Sets the default text color used to display the optional text next to new RADIO buttons.

#### Prototype

```
void RADIO_SetDefaultTextColor(GUI_COLOR TextColor);
```



#### Parameters

Parameter	Description
<code>TextColor</code>	New color to be used.

#### Additional information

For information about how to add text to a RADIO widget, refer to `RADIO_SetText()`.

### 7.2.24.5.1.24 RADIO\_SetFocusColor()

Before	After
	

#### Description

Sets the color used to render the focus rectangle of the RADIO button.

#### Prototype

```
GUI_COLOR RADIO_SetFocusColor(RADIO_Handle hObj,
                               GUI_COLOR   Color);
```

#### Parameters

Parameter	Description
<code>hObj</code>	Handle of RADIO widget.
<code>Color</code>	<code>Color</code> to be used for the focus rectangle.

#### Return value

Previous color of the focus rectangle.

#### Additional information

The focus rectangle is only visible if the widget has the input focus.

### 7.2.24.5.1.25 RADIO\_SetFont()

Before	After
	

#### Description

Sets the font used to display the optional text next to the RADIO buttons.

#### Prototype

```
void RADIO_SetFont(      RADIO_Handle  hObj,
                       const GUI_FONT  * pFont);
```

#### Parameters

Parameter	Description
<code>hObj</code>	Handle of RADIO widget.
<code>pFont</code>	Pointer to GUI_FONT structure to be used to display the text.

#### Additional information

For information about how to add text to a RADIO widget, refer to `RADIO_SetText()`.

### 7.2.24.5.1.26 RADIO\_SetGroupId()



#### Description

Sets the group ID of the RADIO widget.

#### Prototype

```
void RADIO_SetGroupId(RADIO_Handle hObj,
                    U8 NewGroupId);
```

#### Parameters

Parameter	Description
<code>hObj</code>	Handle of RADIO widget.
<code>GroupId</code>	ID of the RADIO button group. Must be between 1 and 255. If the value is 0 the RADIO widget is not assigned to a RADIO button group.

#### Additional information

This command can be used to create groups of RADIO buttons. The behavior of one group is the same as the behavior of one RADIO button. This makes it possible to create for example 2 RADIO widgets side by side with 3 buttons each and build one group of them.

#### Example

The following example shows how to create a group of 2 RADIO widgets as shown in the screenshot at the beginning of the function description:

```
hRadio_0 = RADIO_CreateEx(10, 10, 60, 0, WM_HBKWIN, WM_CF_SHOW, 0, 1234, 3, 20);
RADIO_SetText(hRadio_0, "Red", 0);
RADIO_SetText(hRadio_0, "Green", 1);
RADIO_SetText(hRadio_0, "Blue", 2);
hRadio_1 = RADIO_CreateEx(65, 10, 60, 0, WM_HBKWIN, WM_CF_SHOW, 0, 1234, 3, 20);
RADIO_SetText(hRadio_1, "Magenta", 0);
RADIO_SetText(hRadio_1, "Cyan", 1);
RADIO_SetText(hRadio_1, "Yellow", 2);
RADIO_SetGroupId(hRadio_0, 1);
RADIO_SetGroupId(hRadio_1, 1);
```

### 7.2.24.5.1.27 RADIO\_SetImage()

#### Description

Sets the images used to draw the RADIO button.

#### Prototype

```
void RADIO_SetImage(    RADIO_Handle  hObj,  
                       const GUI_BITMAP * pBitmap,  
                       unsigned int   Index);
```

#### Parameters

Parameter	Description
<a href="#">hObj</a>	Handle of RADIO widget.
<a href="#">pBitmap</a>	Pointer to the bitmap.
<a href="#">Index</a>	See <i>RADIO bitmap indexes</i> on page 2155.

#### Additional information

See `RADIO_SetDefaultImage()`.

### 7.2.24.5.1.28 RADIO\_SetSpacing()

#### Description

Sets the vertical spacing between the items.

#### Prototype

```
void RADIO_SetSpacing(RADIO_Handle hObj,  
                     U16          Spacing);
```

#### Parameters

Parameter	Description
<code>hObj</code>	Handle of RADIO widget.
<code>Spacing</code>	<code>Spacing</code> between items in pixels.

### 7.2.24.5.1.29 RADIO\_SetText()

#### Description

Sets the optional text shown next to the RADIO buttons.

#### Prototype

```
void RADIO_SetText(      RADIO_Handle  hObj,
                        const char    * s,
                        unsigned      Index);
```

#### Parameters

Parameter	Description
<code>hObj</code>	Handle of RADIO widget.
<code>pText</code>	Pointer to the text to be shown next to the specified RADIO button.
<code>Index</code>	Zero based index of the RADIO button.

Before	After
	

#### Additional information

If using a RADIO widget without text (old style) the focus rectangle is drawn around the buttons of the widget. If using RADIO button text the focus rectangle is shown around the text of the currently selected RADIO button of the widget.

#### Example

The following example shows how to add the text shown in the screenshot above:

```
RADIO_SetText(hRadio_0, "Red", 0);
RADIO_SetText(hRadio_0, "Green", 1);
RADIO_SetText(hRadio_0, "Blue", 2);
```

### 7.2.24.5.1.30 RADIO\_SetTextColor()

Before	After
	

#### Description

Sets the text color used to show the optional text beside the RADIO buttons.

#### Prototype

```
void RADIO_SetTextColor(RADIO_Handle hObj,
                       GUI_COLOR   Color);
```

#### Parameters

Parameter	Description
<code>hObj</code>	Handle of RADIO widget.
<code>Color</code>	<code>Color</code> used to show the text.

#### Additional information

For information about how to add text to a RADIO widget, refer to `RADIO_SetText()`.



### 7.2.24.5.1.31 RADIO\_SetUserData()

#### Description

Prototype explained at the beginning of the chapter as `<WIDGET>_SetUserData()` on page 1166.

### 7.2.24.5.1.32 RADIO\_SetValue()

#### Description

Sets the current button selection.

#### Prototype

```
void RADIO_SetValue(RADIO_Handle hObj,  
                   int           v);
```

#### Parameters

Parameter	Description
<code>hObj</code>	Handle of RADIO widget.
<code>v</code>	Value to be set.

#### Additional information

The topmost RADIO button in a RADIO widget always has the 0 value, the next button down is always 1, the next is 2, etc.

## 7.2.24.5.2 Defines

### 7.2.24.5.2.1 RADIO bitmap indexes

#### Description

Bitmap indexes used by routines to change the bitmaps of a RADIO widget.

#### Definition

```
#define RADIO_BI_INACTIVE    0
#define RADIO_BI_ACTIVE     1
#define RADIO_BI_CHECK      2
```

#### Symbols

Definition	Description
<a href="#">RADIO_BI_INACTIVE</a>	Outer image used to show a disabled RADIO button.
<a href="#">RADIO_BI_ACTIVE</a>	Outer image used to show a enabled RADIO button.
<a href="#">RADIO_BI_CHECK</a>	Inner image used to mark the selected item.

## 7.2.24.6 Examples

The `Sample` folder contains the following example which shows how the widget can be used:

- `DIALOG_Radio.c`

Note that several other examples also make use of this widget and may also be helpful to get familiar with the widget.

### Screenshot of `DIALOG_Radio.c`

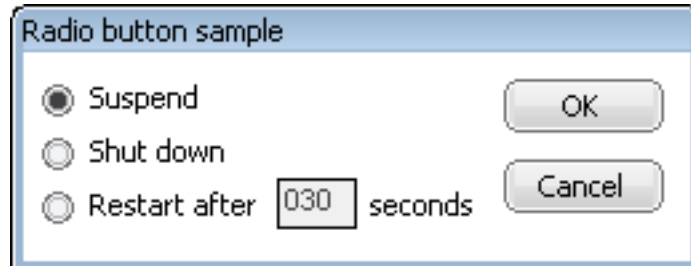

## 7.2.25 ROTARY: Rotary widget

The ROTARY widget is a reworked version of the KNOB widget, therefore they share some similarities. Just as the KNOB, the ROTARY is a widget the user can rotate. From the rotation degree values are determined which can be used within the application.

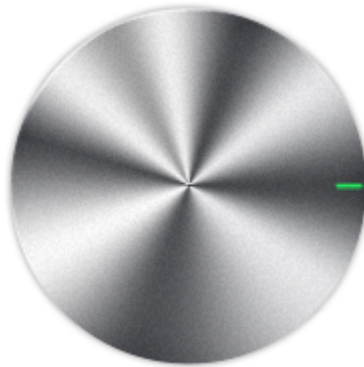

A ROTARY widget consists of a background bitmap and a marker bitmap. Optionally, the marker bitmap can be rotated while the widget is rotating, but the background bitmap does not rotate.

### Note

All ROTARY-related routines are located in the file(s) `ROTARY.c` and `ROTARY.h`. All identifiers are prefixed with `ROTARY`.

### Ticks and tick size

Just as with the KNOB widget, a ROTARY is divided into ticks. A tick describes the smallest range of movement of a ROTARY widget. The smallest size of one tick (tick size = 1) equates to 1/10 of a degree. Therefore it takes 3600 ticks to fulfill one round. The size of one tick can be set with the function `ROTARY_SetTickSize()`.

Examples	
Ticksize	Ticks for one round
60	60
36	100
300	12

### Memory requirements

While the KNOB widget uses a memory device for the entire background, the ROTARY widget doesn't. This is not necessary since the background of the ROTARY is not rotated. Only the marker of a ROTARY can be rotated. If the user chooses to rotate the marker, the memory usage will be a bit higher, depending on the size of the marker bitmap.

### 7.2.25.1 Configuration options

Type	Macro	Default	Description
N	<code>ROTARY_PERIOD_DEFAULT</code>	1500	Period in ms it takes the ROTARY to stop.
N	<code>ROTARY_TICKSIZE_DEFAULT</code>	1	Size of one tick in 1/10 of degree.

## 7.2.25.2 Predefined IDs

The following symbols define IDs which may be used to make ROTARY widgets distinguishable from creation.

```
#define GUI_ID_ROTARY0    0x310
#define GUI_ID_ROTARY1    0x311
#define GUI_ID_ROTARY2    0x312
#define GUI_ID_ROTARY3    0x313
#define GUI_ID_ROTARY4    0x314
#define GUI_ID_ROTARY5    0x315
#define GUI_ID_ROTARY6    0x316
#define GUI_ID_ROTARY7    0x317
#define GUI_ID_ROTARY8    0x318
#define GUI_ID_ROTARY9    0x319
```

## 7.2.25.3 Notification codes

The following events are sent from a ROTARY widget to its parent window as part of a WM\_NOTIFY\_PARENT message:

Message	Description
WM_NOTIFICATION_CLICKED	ROTARY has been clicked.
WM_NOTIFICATION_RELEASED	ROTARY has been released.
WM_NOTIFICATION_MOTION_STOPPED	Movement of the ROTARY has stopped.
WM_NOTIFICATION_MOVED_OUT	ROTARY has been clicked and pointer has been moved out of the ROTARY area without releasing.
WM_NOTIFICATION_VALUE_CHANGED	The value of the ROTARY widget has been changed.

## 7.2.25.4 Keyboard reaction

The widget reacts to the following keys if it has the input focus. Depending on the arrow key, per press the size of one tick is either added or subtracted to the ROTARY's angle.

Key	Reaction
GUI_KEY_RIGHT	The ROTARY rotates CW.
GUI_KEY_LEFT	The ROTARY rotates CCW.
GUI_KEY_DOWN	The ROTARY rotates CW.
GUI_KEY_UP	The ROTARY rotates CCW.

## 7.2.25.5 ROTARY API

Routine	Description
<code>ROTARY_AddAngle()</code>	Adds an angle to a ROTARY widget.
<code>ROTARY_AddValue()</code>	Adds a given value to a ROTARY widget.
<code>ROTARY_CreateEx()</code>	Creates a ROTARY widget.
<code>ROTARY_CreateIndirect()</code>	Creates a ROTARY widget from a resource table entry.
<code>ROTARY_CreateUser()</code>	Creates a ROTARY widget using extra bytes as user data.
<code>ROTARY_GetAngle()</code>	Returns the current angle of a ROTARY widget.
<code>ROTARY_GetImageSize()</code>	Returns the size of the background image.
<code>ROTARY_GetMarkerSize()</code>	Returns the size of the marker bitmap.
<code>ROTARY_GetUserData()</code>	Retrieves the data set with <code>ROTARY_SetUserData()</code> .
<code>ROTARY_GetValue()</code>	Returns the value of a ROTARY widget.
<code>ROTARY_SetAngle()</code>	Sets the current angle of a ROTARY widget.
<code>ROTARY_SetBitmap()</code>	Sets the background bitmap of a ROTARY widget.
<code>ROTARY_SetDoRotate()</code>	Sets the marker image of a ROTARY widget to be rotated.
<code>ROTARY_SetMarker()</code>	Sets the marker bitmap of a ROTARY widget.
<code>ROTARY_SetOffset()</code>	Sets the offset of a ROTARY widget.
<code>ROTARY_SetPeriod()</code>	Sets the period of a ROTARY widget.
<code>ROTARY_SetRadius()</code>	Sets the radius of a ROTARY widget.
<code>ROTARY_SetRange()</code>	Sets the usable range of a ROTARY widget.
<code>ROTARY_SetSnap()</code>	Sets a snap position for a ROTARY widget.
<code>ROTARY_SetTickSize()</code>	Sets the tick size of a ROTARY widget.
<code>ROTARY_SetUserData()</code>	Sets the extra data of a ROTARY widget.
<code>ROTARY_SetValue()</code>	Sets the value of a ROTARY widget.
<code>ROTARY_SetValueRange()</code>	Sets the usable range of values of a ROTARY widget.

### 7.2.25.5.1 ROTARY\_AddAngle()

#### Description

Adds an angle to a ROTARY widget.

#### Prototype

```
void ROTARY_AddAngle(ROTARY_Handle hObj,  
                    I32             Delta);
```

#### Parameters

Parameter	Description
<a href="#">hObj</a>	Handle of a ROTARY widget.
<a href="#">Delta</a>	Angle in 10ths of degrees to be added.



### 7.2.25.5.2 ROTARY\_AddValue()

#### Description

Adds a given value to a ROTARY widget.

#### Prototype

```
void ROTARY_AddValue(ROTARY_Handle hObj,  
                    I32           Delta);
```

#### Parameters

Parameter	Description
<code>hObj</code>	Handle of a ROTARY widget.
<code>Delta</code>	Value to be added.

### 7.2.25.5.3 ROTARY\_CreateEx()

#### Description

Creates a ROTARY widget.

#### Prototype

```
ROTARY_Handle ROTARY_CreateEx(int    x0,
                              int    y0,
                              int    xSize,
                              int    ySize,
                              WM_HWIN hParent,
                              int    WinFlags,
                              int    Id);
```

#### Parameters

Parameter	Description
<code>x0</code>	Leftmost pixel of the ROTARY widget (in parent coordinates).
<code>y0</code>	Topmost pixel of the ROTARY widget (in parent coordinates).
<code>xSize</code>	Horizontal size of the ROTARY widget (in pixels).
<code>ySize</code>	Vertical size of the ROTARY widget (in pixels).
<code>hParent</code>	Parent window of the ROTARY widget.
<code>WinFlags</code>	Window create flags. Typically <code>WM_CF_SHOW</code> in order to make the widget visible immediately (refer to <i>Window create flags</i> on page 1146 for a list of available parameter values).
<code>Id</code>	ID of the ROTARY widget.

#### Return value

Handle of ROTARY widget.

#### 7.2.25.5.4 ROTARY\_CreateIndirect()

##### Description

Prototype explained at the beginning of the chapter as `<WIDGET>_CreateIndirect()` on page 1161. The elements `Flags` and `Para` of the resource passed as parameter are not used.

### 7.2.25.5.5 ROTARY\_CreateUser()

#### Description

Prototype explained at the beginning of the chapter as `<WIDGET>_CreateUser()` on page 1162. For a detailed description of the parameters the function `KNOB_CreateEx()` can be referred to.

### 7.2.25.5.6 ROTARY\_GetAngle()

#### Description

Returns the current angle of a ROTARY widget.

#### Prototype

```
I32 ROTARY_GetAngle(ROTARY_Handle hObj);
```

#### Parameters

Parameter	Description
<a href="#">hObj</a>	Handle of a ROTARY widget.

#### Return value

Angle of the ROTARY widget.

### 7.2.25.5.7 ROTARY\_GetImageSize()

#### Description

Returns the size of the background image.

#### Prototype

```
int ROTARY_GetImageSize(ROTARY_Handle  hObj,  
                        int            * pxSize,  
                        int            * pySize);
```

#### Parameters

Parameter	Description
<code>hObj</code>	Handle of a ROTARY widget.
<code>pxSize</code>	Pointer to an integer to store the x-size.
<code>pySize</code>	Pointer to an integer to store the y-size.

#### Return value

- 0        If the routine succeeds.
- 1        If the routine fails.

### 7.2.25.5.8 ROTARY\_GetMarkerSize()

#### Description

Returns the size of the marker bitmap.

#### Prototype

```
int ROTARY_GetMarkerSize(ROTARY_Handle  hObj,  
                        int             * pxSize,  
                        int             * pySize);
```

#### Parameters

Parameter	Description
<code>hObj</code>	Handle of a ROTARY widget.
<code>pxSize</code>	Pointer to an integer to store the x-size.
<code>pySize</code>	Pointer to an integer to store the y-size.

#### Return value

- 0        If the routine succeeds.
- 1        If the routine fails.

### 7.2.25.5.9 ROTARY\_GetUserData()

#### Description

Prototype explained at the beginning of the chapter as `<WIDGET>_GetUserData()` on page 1165.



### 7.2.25.5.10 ROTARY\_GetValue()

#### Description

Returns the value of a ROTARY widget. This value depends on the set range of the widget.

#### Prototype

```
I32 ROTARY_GetValue(ROTARY_Handle hObj);
```

#### Parameters

Parameter	Description
<a href="#">hObj</a>	Handle of a ROTARY widget.

#### Return value

Value of the ROTARY widget.

### 7.2.25.5.11 ROTARY\_SetAngle()

#### Description

Sets the current angle of a ROTARY widget. The angle has to be within the valid range.

#### Prototype

```
void ROTARY_SetAngle(ROTARY_Handle hObj,  
                    I32 Pos);
```

#### Parameters

Parameter	Description
<code>hObj</code>	Handle of a ROTARY widget.
<code>Pos</code>	Angle in 10ths of degrees to be added.

### 7.2.25.5.12 ROTARY\_SetBitmap()

#### Description

Sets the background bitmap of a ROTARY widget. This bitmap won't be rotated.

#### Prototype

```
void ROTARY_SetBitmap(    ROTARY_Handle  hObj,  
                        const GUI_BITMAP * pBitmap);
```

#### Parameters

Parameter	Description
<code>hObj</code>	Handle of a ROTARY widget.
<code>pBitmap</code>	Pointer to a bitmap.

### 7.2.25.5.13 ROTARY\_SetDoRotate()

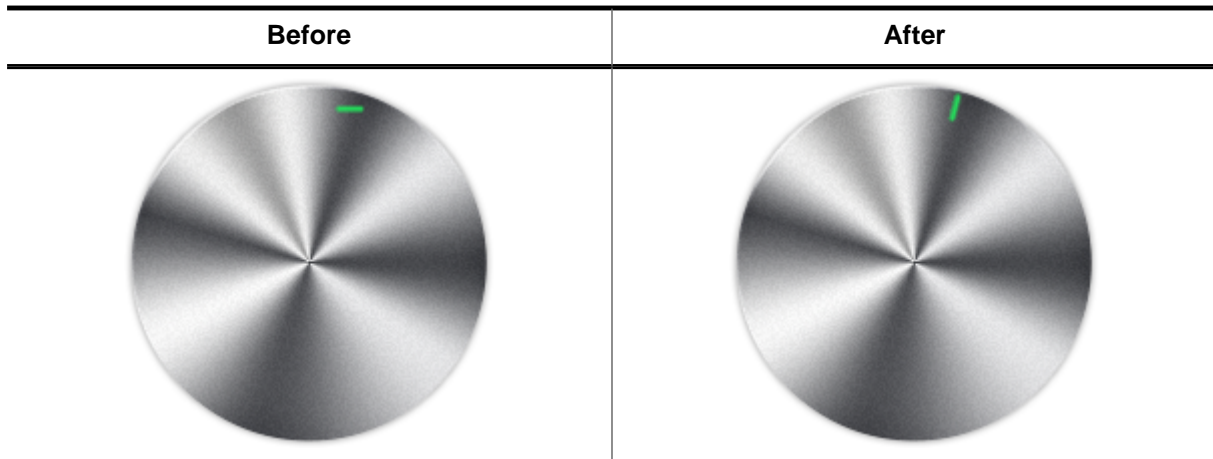

#### Description

Sets the marker image of a ROTARY widget to be rotated.

#### Prototype

```
void ROTARY_SetDoRotate(ROTARY_Handle hObj,  
                        U8 DoRotate);
```

#### Parameters

Parameter	Description
hObj	Handle of a ROTARY widget.
DoRotate	If the marker bitmap should be rotated.

### 7.2.25.5.14 ROTARY\_SetMarker()

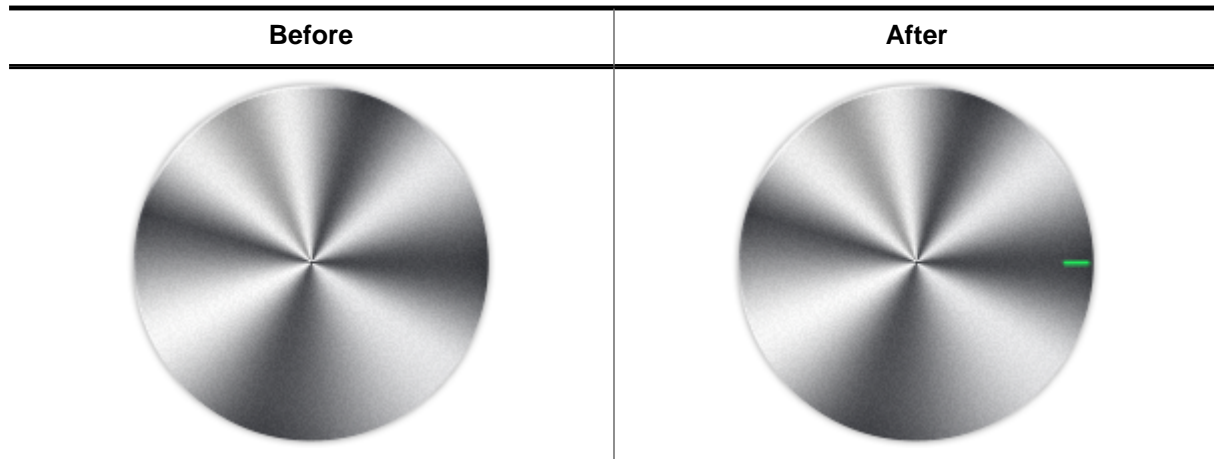

#### Description

Sets the marker bitmap of a ROTARY widget.

#### Prototype

```
void ROTARY_SetMarker(    ROTARY_Handle  hObj,
                        const GUI_BITMAP * pBitmap,
                        int           Radius,
                        I32           Offset,
                        U8            DoRotate);
```

#### Parameters

Parameter	Description
<a href="#">hObj</a>	Handle of a ROTARY widget.
<a href="#">pBitmap</a>	Pointer to a bitmap to be set as marker.
<a href="#">Radius</a>	Mid-point difference between widget and marker bitmap.
<a href="#">Offset</a>	Angle offset in 10ths of degrees for drawing marker.
<a href="#">DoRotate</a>	If the marker bitmap should be rotated.

### 7.2.25.5.15 ROTARY\_SetOffset()

#### Description

Sets the offset of a ROTARY widget.

#### Prototype

```
void ROTARY_SetOffset(ROTARY_Handle hObj,  
                      int           Offset);
```

#### Parameters

Parameter	Description
<code>hObj</code>	Handle of a ROTARY widget.
<code>Offset</code>	<code>Offset</code> to be set.

### 7.2.25.5.16 ROTARY\_SetPeriod()

#### Description

Sets the period of a ROTARY widget. This period determines when the rotation of the widget stops.

#### Prototype

```
void ROTARY_SetPeriod(ROTARY_Handle hObj,  
                     I32             Period);
```

#### Parameters

Parameter	Description
<code>hObj</code>	Handle of a ROTARY widget.
<code>Period</code>	<code>Period</code> to be set.

#### Additional information

The default period is 1500ms. The maximum value for the period is 46340ms.

### 7.2.25.5.17 ROTARY\_SetRadius()

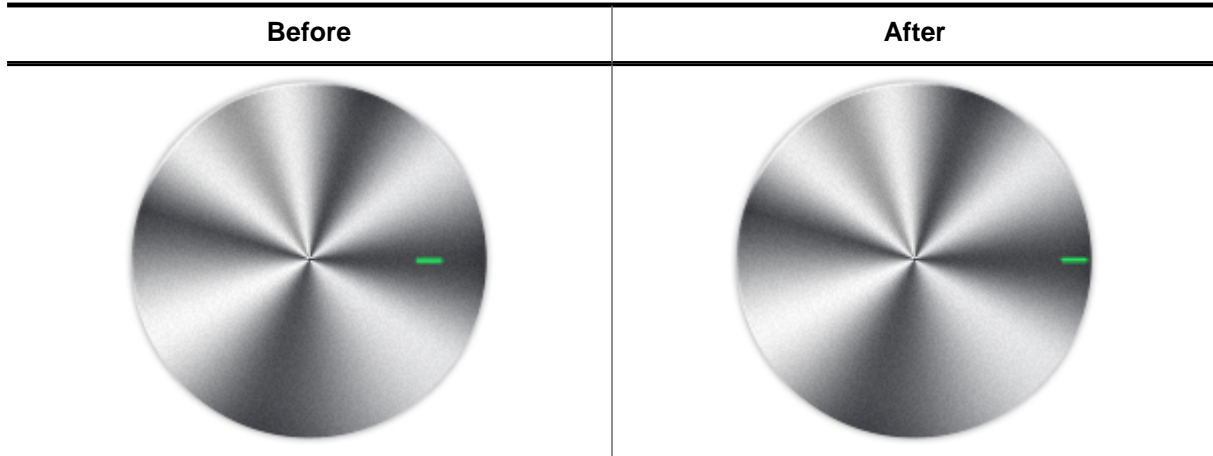

#### Description

Sets the radius of a ROTARY widget.

#### Prototype

```
void ROTARY_SetRadius(ROTARY_Handle hObj,  
                     int           Radius);
```

#### Parameters

Parameter	Description
<code>hObj</code>	Handle of a ROTARY widget.
<code>Radius</code>	<code>Radius</code> of the ROTARY widget.



### 7.2.25.5.18 ROTARY\_SetRange()

#### Description

Sets the usable range of a ROTARY widget.

#### Prototype

```
void ROTARY_SetRange(ROTARY_Handle hObj,  
                    U32           AngPositive,  
                    U32           AngNegative);
```

#### Parameters

Parameter	Description
<a href="#">hObj</a>	Handle of a ROTARY widget.
<a href="#">AngPositive</a>	Starting angle in 10ths of degrees .
<a href="#">AngNegative</a>	Ending angle in 10ths of degrees .

### 7.2.25.5.19 ROTARY\_SetSnap()

#### Description

Sets a snap position for a ROTARY widget. A snap position is a position measured in ticks where the widget automatically stops rotating.

#### Prototype

```
void ROTARY_SetSnap(ROTARY_Handle hObj,  
                   I32           Snap);
```

#### Parameters

Parameter	Description
<a href="#">hObj</a>	Handle of a ROTARY widget.
<a href="#">Snap</a>	<a href="#">Snap</a> position to be set.

#### Additional information

The default value is 0. If set to 0, there is no snap position.

### 7.2.25.5.20 ROTARY\_SetTickSize()

#### Description

Sets the tick size of a ROTARY widget. The tick size is measured in 10th of degrees.

#### Prototype

```
void ROTARY_SetTickSize(ROTARY_Handle hObj,  
                        I32           TickSize);
```

#### Parameters

Parameter	Description
<code>hObj</code>	Handle of a ROTARY widget.
<code>TickSize</code>	Tick size of the ROTARY widget.

#### Additional information

This routine has to be called before any other ROTARY related routines, except any ROTARY\_Create...() routines of course.

### 7.2.25.5.21 ROTARY\_SetUserData()

#### Description

Prototype explained at the beginning of the chapter as `<WIDGET>_SetUserData()` on page 1166.

### 7.2.25.5.22 ROTARY\_SetValue()

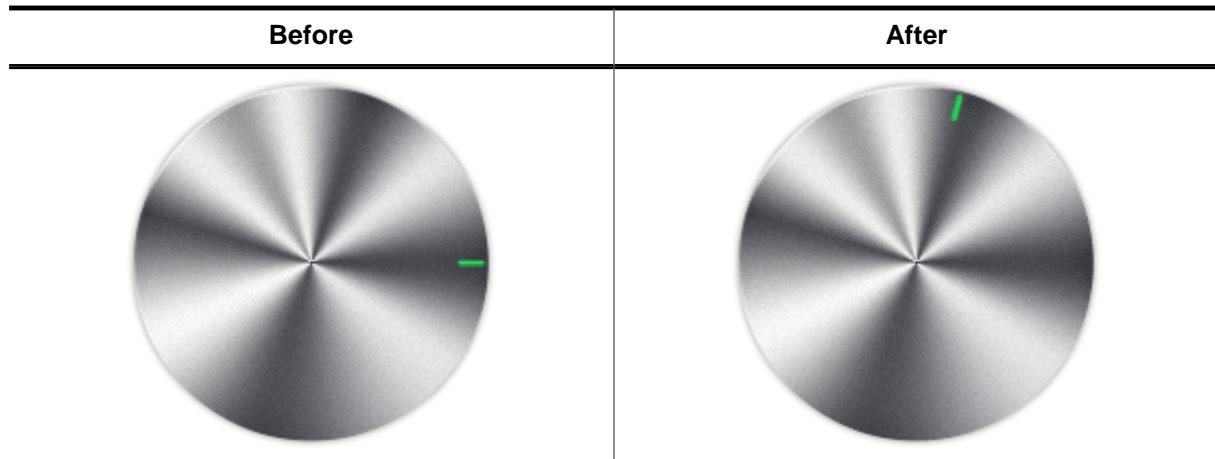

#### Description

Sets the value of a ROTARY widget.

#### Prototype

```
void ROTARY_SetValue(ROTARY_Handle hObj,
                    I32          Value);
```

#### Parameters

Parameter	Description
hObj	Handle of a ROTARY widget.
Value	Value to be added.

#### Additional information

The angle depends on the range set with `ROTARY_SetRange()` and `ROTARY_SetValueRange()`.

### 7.2.25.5.23 ROTARY\_SetValueRange()

#### Description

Sets the usable range of values of a ROTARY widget.

#### Prototype

```
int ROTARY_SetValueRange(ROTARY_Handle hObj,  
                        I32           Min,  
                        I32           Max);
```

#### Parameters

Parameter	Description
<a href="#">hObj</a>	Handle of a ROTARY widget.
<a href="#">Min</a>	Minimum value.
<a href="#">Max</a>	Maximum value.

#### Return value

- 0 If the routine succeeds.
- 1 If the routine fails.

## 7.2.26 SCROLLBAR: Scroll bar widget

### Note

For more modern-looking GUIs the SCROLLER widget may be used instead.

Scroll bars are used for scrolling through list boxes or any other type of window. They may be created horizontally, as shown below, or vertically.



A scroll bar is typically attached to an existing window, for example the list box shown below:



### Note

All SCROLLBAR-related routines are located in the file(s) `SCROLLBAR*.c`, `SCROLLBAR.h`. All identifiers are prefixed `SCROLLBAR`.

### Skining...



...is available for this widget. The screenshot above shows the widget using the default skin. Details can be found in the chapter *Skining* on page 2800.

### Note

This widget uses skinning. To change the look it is recommended to use the function `<WIDGET>_SetSkinFlexProps()`. Other functions to change the look might work only with the classic skin.

### 7.2.26.1 Configuration options

Type	Macro	Default	Description
N	<code>SCROLLBAR_COLOR_SHAFT_DEFAULT</code>	<code>0x808080</code>	Color of the shaft.
N	<code>SCROLLBAR_COLOR_ARROW_DEFAULT</code>	<code>GUI_BLACK</code>	Color of the arrows.
N	<code>SCROLLBAR_COLOR_THUMB_DEFAULT</code>	<code>0xc0c0c0</code>	Color of the thumb area.
N	<code>SCROLLBAR_THUMB_SIZE_MIN_DEFAULT</code>	<code>4</code>	Minimum thumb size.

### 7.2.26.2 Predefined IDs

The following symbols define IDs which may be used to make SCROLLBAR widgets distinguishable from creation.

```
#define GUI_ID_SCROLLBAR0    0x140
#define GUI_ID_SCROLLBAR1    0x141
#define GUI_ID_SCROLLBAR2    0x142
#define GUI_ID_SCROLLBAR3    0x143
#define GUI_ID_SCROLLBAR4    0x144
#define GUI_ID_SCROLLBAR5    0x145
#define GUI_ID_SCROLLBAR5    0x146
#define GUI_ID_SCROLLBAR7    0x147
```

```
#define GUI_ID_SCROLLBAR8 0x148  
#define GUI_ID_SCROLLBAR9 0x149
```



### 7.2.26.3 Notification codes

The following events are sent from a scroll bar widget to its parent window as part of a WM\_NOTIFY\_PARENT message:

Message	Description
WM_NOTIFICATION_CLICKED	SCROLLBAR has been clicked.
WM_NOTIFICATION_RELEASED	SCROLLBAR has been released.
WM_NOTIFICATION_SCROLLBAR_ADDED	SCROLLBAR has just been added (attached) to an existing window. The window needs to be informed so that it can initialize the scroll bar.
WM_NOTIFICATION_VALUE_CHANGED	Value of SCROLLBAR has changed, either by moving the thumb or by pressing the arrow buttons.

### 7.2.26.4 Keyboard reaction

The widget reacts to the following keys if it has the input focus:

Message	Description
GUI_KEY_RIGHT	Increments the current value of the SCROLLBAR widget by 1.
GUI_KEY_DOWN	Increments the current value of the SCROLLBAR widget by 1.
GUI_KEY_PGDOWN	Increments the current value of the SCROLLBAR widget by a value which represents 1 page.
GUI_KEY_LEFT	Decrements the current value of the SCROLLBAR widget by 1.
GUI_KEY_UP	Decrements the current value of the SCROLLBAR widget by 1.
GUI_KEY_PGUP	Decrements the current value of the SCROLLBAR widget by a value which represents 1 page.

## 7.2.26.5 SCROLLBAR API

The table below lists the available emWin SCROLLBAR-related routines in alphabetical order. Detailed descriptions of the routines follow.

### Functions

Routine	Description
<code>SCROLLBAR_AddValue()</code>	Increments or decrements the value of the SCROLLBAR widget by a specified value.
<code>SCROLLBAR_Create()</code>	Creates a SCROLLBAR widget. (Obsolete)
<code>SCROLLBAR_CreateAttached()</code>	Creates a SCROLLBAR widget attached to a window.
<code>SCROLLBAR_CreateEx()</code>	Creates a SCROLLBAR widget.
<code>SCROLLBAR_CreateIndirect()</code>	Creates a SCROLLBAR widget from resource table entry.
<code>SCROLLBAR_CreateUser()</code>	Creates a SCROLLBAR widget using extra bytes as user data.
<code>SCROLLBAR_Dec()</code>	Decrements the current value of the given SCROLLBAR widget by a value of 1.
<code>SCROLLBAR_GetColor()</code>	Returns the color attributes of the SCROLLBAR.
<code>SCROLLBAR_GetDefaultWidth()</code>	Returns the default width of a SCROLLBAR widget.
<code>SCROLLBAR_GetNumItems()</code>	Returns the number of SCROLLBAR items.
<code>SCROLLBAR_GetPageSize()</code>	Returns the page size.
<code>SCROLLBAR_GetThumbSizeMin()</code>	Returns the minimum thumb size in pixels.
<code>SCROLLBAR_GetUserData()</code>	Retrieves the data set with <code>SCROLLBAR_SetUserData()</code> .
<code>SCROLLBAR_GetValue()</code>	Returns the value of the current item.
<code>SCROLLBAR_Inc()</code>	Increments the current value of the given SCROLLBAR widget by a value of 1.
<code>SCROLLBAR_SetColor()</code>	Sets the color of a SCROLLBAR widget.
<code>SCROLLBAR_SetDefaultColor()</code>	Sets the default colors for new SCROLLBAR widgets.
<code>SCROLLBAR_SetDefaultWidth()</code>	Sets the default width of SCROLLBAR widgets.
<code>SCROLLBAR_SetNumItems()</code>	Sets the number of items for scrolling.
<code>SCROLLBAR_SetPageSize()</code>	Sets the page size.
<code>SCROLLBAR_SetState()</code>	Sets the state of a SCROLLBAR widget.
<code>SCROLLBAR_SetThumbSizeMin()</code>	Sets the minimum thumb size in pixels.
<code>SCROLLBAR_SetUserData()</code>	Sets the extra data of a SCROLLBAR widget.
<code>SCROLLBAR_SetValue()</code>	Sets the value of the given SCROLLBAR widget.
<code>SCROLLBAR_SetWidth()</code>	Sets the width of the given SCROLLBAR widget.

### Defines

Group of defines	Description
<code>SCROLLBAR_color_indexes</code>	Color indexes for SCROLLBAR widget.
<code>SCROLLBAR_create_flags</code>	Create flags to be used for creating SCROLLBAR widgets.

## 7.2.26.5.1 Functions

### 7.2.26.5.1.1 SCROLLBAR\_AddValue()

#### Description

Increments or decrements the value of the SCROLLBAR widget by a specified value.

#### Prototype

```
void SCROLLBAR_AddValue(SCROLLBAR_Handle hObj,  
                        int Add);
```

#### Parameters

Parameter	Description
<a href="#">hObj</a>	Handle of SCROLLBAR.
<a href="#">Add</a>	Number of items to increment or decrement at one time.

#### Additional information

The SCROLLBAR widget cannot exceed the value set in `SCROLLBAR_SetNumItems()`. For example, if a window contains 200 items and the scroll bar is currently at value 195, incrementing the bar by 3 items will move it to value 198. However, incrementing by 10 items will only move the bar as far as value 200, which is the maximum value for this particular window.

### 7.2.26.5.1.2 SCROLLBAR\_Create()

#### Note

This function is **deprecated**, `SCROLLBAR_CreateEx()` should be used instead.

#### Description

Creates a SCROLLBAR widget of a specified size at a specified location.

#### Prototype

```
SCROLLBAR_Handle SCROLLBAR_Create(int    x0,
                                   int    y0,
                                   int    xSize,
                                   int    ySize,
                                   WM_HWIN hParent,
                                   int    Id,
                                   int    WinFlags,
                                   int    SpecialFlags);
```

#### Parameters

Parameter	Description
<code>x0</code>	Leftmost pixel of the SCROLLBAR widget (in parent coordinates).
<code>y0</code>	Topmost pixel of the SCROLLBAR widget (in parent coordinates).
<code>xSize</code>	Horizontal size of the SCROLLBAR widget (in pixels).
<code>ySize</code>	Vertical size of the SCROLLBAR widget (in pixels).
<code>hParent</code>	Handle of parent window.
<code>Id</code>	ID to be returned.
<code>WinFlags</code>	Window create flags. Typically <code>WM_CF_SHOW</code> in order to make the widget visible immediately (refer to <i>Window create flags</i> on page 1146 for a list of available parameter values).
<code>SpecialFlags</code>	Special creation flags. Permitted values are listed under <code>SCROLLBAR_CreateEx()</code> .

#### Return value

Handle of the created SCROLLBAR widget; 0 if the function fails.

### 7.2.26.5.1.3 SCROLLBAR\_CreateAttached()

#### Description

Creates a scroll bar which is attached to an existing window.

#### Prototype

```
SCROLLBAR_Handle SCROLLBAR_CreateAttached(WM_HWIN hParent,
                                           int SpecialFlags);
```

#### Parameters

Parameter	Description
hParent	Handle of parent window.
SpecialFlags	Special creation flags. Permitted values are listed under SCROLLBAR_CreateEx().

#### Return value

Handle of the created SCROLLBAR widget; 0 if the function fails.

#### Additional information

An attached SCROLLBAR widget is essentially a child window which will position itself on the parent window and operate accordingly. Vertical attached SCROLLBAR widgets will be automatically placed on the right side of the parent window; horizontal SCROLLBAR widgets on the bottom. Since no more than one horizontal and one vertical SCROLLBAR widget can be attached to a parent window, no ID needs to be passed as parameter. The following fixed ID's will automatically be assigned when an attached SCROLLBAR widget is created: GUI\_ID\_HSCROLL for a horizontal SCROLLBAR widget, and GUI\_ID\_VSCROLL for a vertical SCROLLBAR widget.

#### Example

Creates a list box with an attached SCROLLBAR widget:

```
LISTBOX_Handle hListBox;
hListBox = LISTBOX_Create(ListBox, 50, 50, 100, 100, WM_CF_SHOW);
SCROLLBAR_CreateAttached(hListBox, SCROLLBAR_CF_VERTICAL);
```

#### Screenshots of above example

The picture on the left shows the list box as it appears after creation. On the right it is shown with the attached vertical scroll bar:



### 7.2.26.5.1.4 SCROLLBAR\_CreateEx()

#### Description

Creates a SCROLLBAR widget of a specified size at a specified location.

#### Prototype

```
SCROLLBAR_Handle SCROLLBAR_CreateEx(int    x0,
                                     int    y0,
                                     int    xSize,
                                     int    ySize,
                                     WM_HWIN hParent,
                                     int    WinFlags,
                                     int    ExFlags,
                                     int    Id);
```

#### Parameters

Parameter	Description
<code>x0</code>	Leftmost pixel of the widget (in parent coordinates).
<code>y0</code>	Topmost pixel of the widget (in parent coordinates).
<code>xSize</code>	Horizontal size of the widget (in pixels).
<code>ySize</code>	Vertical size of the widget (in pixels).
<code>hParent</code>	Handle of parent window. If 0, the new SCROLLBAR widget will be a child of the desktop (top-level window).
<code>WinFlags</code>	Window create flags. Typically <code>WM_CF_SHOW</code> in order to make the widget visible immediately (refer to <i>Window create flags</i> on page 1146 for a list of available parameter values).
<code>ExFlags</code>	OR-combination of special creation flags. See <i>SCROLLBAR create flags</i> on page 2213 for a list of permitted values.
<code>Id</code>	Window ID of the widget.

#### Return value

Handle of the created SCROLLBAR widget; 0 if the function fails.

### 7.2.26.5.1.5 SCROLLBAR\_CreateIndirect()

#### Description

The prototype of this function is explained at the beginning of this chapter. Details can be found in the description of the function `<WIDGET>_CreateIndirect()` on page 1161. The element `Para` of the according `GUI_WIDGET_CREATE_INFO` structure is not used. The element `Flags` is used according to the parameter `ExFlags` of the function `SCROLLBAR_CreateEx()`.

### 7.2.26.5.1.6 SCROLLBAR\_CreateUser()

#### Description

Prototype explained at the beginning of the chapter as `<WIDGET>_CreateUser()` on page 1162. For a detailed description of the parameters the function `SCROLLBAR_CreateEx()` can be referred to.



### 7.2.26.5.1.7 SCROLLBAR\_Dec()

#### Description

Decrements the current value of the given SCROLLBAR widget by a value of 1.

#### Prototype

```
void SCROLLBAR_Dec(SCROLLBAR_Handle hObj);
```

#### Parameters

Parameter	Description
<a href="#">hObj</a>	Handle of a SCROLLBAR widget.

#### Additional information

The definition of an "item" is application-specific, although in most cases it is equal to one line. Items are numbered top to bottom or left to right, beginning with a value of 0.

### 7.2.26.5.1.8 SCROLLBAR\_GetColor()

#### Description

Returns the color attribute of the given SCROLLBAR widget.

#### Prototype

```
GUI_COLOR SCROLLBAR_GetColor(SCROLLBAR_Handle hObj,  
                              int Index);
```

#### Parameters

Parameter	Description
<a href="#">hObj</a>	Handle of a SCROLLBAR widget.
<a href="#">Index</a>	See <i>SCROLLBAR color indexes</i> on page 2212 for a full list of permitted values.

#### Return value

The color set for the different areas of the SCROLLBAR.

### 7.2.26.5.1.9 SCROLLBAR\_GetDefaultWidth()

#### Description

Returns the default width used to create a SCROLLBAR widget.

#### Prototype

```
int SCROLLBAR_GetDefaultWidth(void);
```

#### Return value

Default width used to create a SCROLLBAR widget.

### 7.2.26.5.1.10 SCROLLBAR\_GetNumItems()

#### Description

Returns the number of SCROLLBAR items.

#### Prototype

```
int SCROLLBAR_GetNumItems(SCROLLBAR_Handle hObj);
```

#### Parameters

Parameter	Description
<a href="#">hObj</a>	Handle of a SCROLLBAR widget.

#### Return value

The number of SCROLLBAR items.

### 7.2.26.5.1.11 SCROLLBAR\_GetPageSize()

#### Description

Returns the page size.

#### Prototype

```
int SCROLLBAR_GetPageSize(SCROLLBAR_Handle hObj);
```

#### Parameters

Parameter	Description
<a href="#">hObj</a>	Handle of a SCROLLBAR widget.

#### Return value

The number of items specified to be one page.

### 7.2.26.5.1.12 SCROLLBAR\_GetThumbSizeMin()

#### Description

Returns the minimum thumb size in pixels.

#### Prototype

```
int SCROLLBAR_GetThumbSizeMin(void);
```

#### Return value

Minimum thumb size in pixels.

### 7.2.26.5.1.13 SCROLLBAR\_GetUserData()

#### Description

Prototype explained at the beginning of the chapter as `<WIDGET>_GetUserData()` on page 1165.

### 7.2.26.5.1.14 SCROLLBAR\_GetValue()

#### Description

Returns the value of the current item.

#### Prototype

```
int SCROLLBAR_GetValue(SCROLLBAR_Handle hObj);
```

#### Parameters

Parameter	Description
<a href="#">hObj</a>	Handle of a SCROLLBAR widget.

#### Return value

The value of the current item.



### 7.2.26.5.1.15 SCROLLBAR\_Inc()

#### Description

Increments the current value of the given SCROLLBAR widget by a value of 1.

#### Prototype

```
void SCROLLBAR_Inc(SCROLLBAR_Handle hObj);
```

#### Parameters

Parameter	Description
<a href="#">hObj</a>	Handle of a SCROLLBAR widget.

#### Additional information

The definition of an "item" is application-specific, although in most cases it is equal to one line. Items are numbered top to bottom or left to right, beginning with a value of 0.

### 7.2.26.5.1.16 SCROLLBAR\_SetColor()

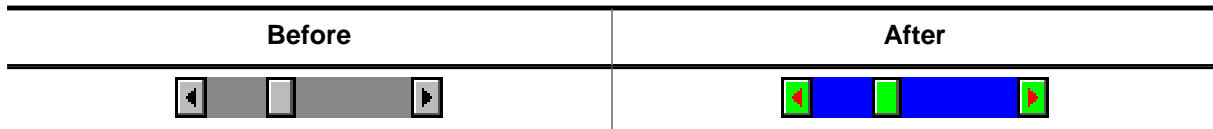

#### Description

Sets the color attribute of the given SCROLLBAR widget.

#### Prototype

```
GUI_COLOR SCROLLBAR_SetColor(SCROLLBAR_Handle hObj,
                              int Index,
                              GUI_COLOR Color);
```

#### Parameters

Parameter	Description
<a href="#">hObj</a>	Handle of a SCROLLBAR widget.
<a href="#">Index</a>	See <i>SCROLLBAR color indexes</i> on page 2212 for a full list of permitted values.
<a href="#">Color</a>	<a href="#">Color</a> to be used.

#### Return value

Previous color used for the given index.

### 7.2.26.5.1.17 SCROLLBAR\_SetDefaultColor()

#### Description

Sets the default color attributes for new SCROLLBAR widgets.

#### Prototype

```
GUI_COLOR SCROLLBAR_SetDefaultColor(GUI_COLOR Color,  
                                     unsigned int Index);
```

#### Parameters

Parameter	Description
<a href="#">Color</a>	<a href="#">Color</a> used as default for newly created SCROLLBAR widgets.
<a href="#">Index</a>	(see table under <i>SCROLLBAR_SetColor</i> on page 2202)

#### Return value

Previous default color.

### 7.2.26.5.1.18 SCROLLBAR\_SetDefaultWidth()

#### Description

Sets the default width used to create a SCROLLBAR widget.

#### Prototype

```
int SCROLLBAR_SetDefaultWidth(int DefaultWidth);
```

#### Parameters

Parameter	Description
DefaultWidth	Default width to use for new SCROLLBAR widgets.

#### Return value

Previous default width.

### 7.2.26.5.1.19 SCROLLBAR\_SetNumItems()

#### Description

Sets the number of items for scrolling.

#### Prototype

```
void SCROLLBAR_SetNumItems(SCROLLBAR_Handle hObj,  
                           int NumItems);
```

#### Parameters

Parameter	Description
<code>hObj</code>	Handle of a SCROLLBAR widget.
<code>NumItems</code>	Number of items to be set.

#### Additional information

The definition of an "item" is application-specific, although in most cases it is equal to one line. The number of items is the maximum value. The SCROLLBAR widget can not go beyond this value.

### 7.2.26.5.1.20 SCROLLBAR\_SetPageSize()

#### Description

Sets the page size.

#### Prototype

```
void SCROLLBAR_SetPageSize(SCROLLBAR_Handle hObj,  
                           int              PageSize);
```

#### Parameters

Parameter	Description
<a href="#">hObj</a>	Handle of a SCROLLBAR widget.
<a href="#">PageSize</a>	Page size (in number of items).

#### Additional information

Page size is specified as the number of items to one page. If the user pages up or down, either with the keyboard or by mouse-clicking in the SCROLLBAR area, the window will be scrolled up or down by the number of items specified as one page.

### 7.2.26.5.1.21 SCROLLBAR\_SetState()

#### Description

Sets the state of a SCROLLBAR widget.

#### Prototype

```
void SCROLLBAR_SetState(      SCROLLBAR_Handle  hObj,  
                             const WM_SCROLL_STATE * pState);
```

#### Parameters

Parameter	Description
<code>hObj</code>	Handle of a SCROLLBAR widget.
<code>pState</code>	Pointer to a data structure of type <code>WM_SCROLL_STATE</code> .

### 7.2.26.5.1.22 SCROLLBAR\_SetThumbSizeMin()

#### Description

Sets the minimum thumb size in pixels.

#### Prototype

```
int SCROLLBAR_SetThumbSizeMin(int ThumbSizeMin);
```

#### Parameters

Parameter	Description
<code>ThumbSizeMin</code>	Minimum thumb size to be set.

#### Return value

Old minimum thumb size in pixels.



### 7.2.26.5.1.23 SCROLLBAR\_SetUserData()

#### Description

Prototype explained at the beginning of the chapter as `<WIDGET>_SetUserData()` on page 1166.

### 7.2.26.5.1.24 SCROLLBAR\_SetValue()

#### Description

Sets the value of the given SCROLLBAR widget.

#### Prototype

```
void SCROLLBAR_SetValue(SCROLLBAR_Handle hObj,  
                        int v);
```

#### Parameters

Parameter	Description
<code>hObj</code>	Handle of a SCROLLBAR widget.
<code>v</code>	Value to be set.

### 7.2.26.5.1.25 SCROLLBAR\_SetWidth()

#### Description

Sets the width of the given SCROLLBAR widget.

#### Prototype

```
int SCROLLBAR_SetWidth(SCROLLBAR_Handle hObj,  
                       int Width);
```

#### Parameters

Parameter	Description
<code>hObj</code>	Handle of a SCROLLBAR widget.
<code>Width</code>	<code>Width</code> to be set.

## 7.2.26.5.2 Defines

### 7.2.26.5.2.1 SCROLLBAR color indexes

#### Description

Color indexes for SCROLLBAR widget.

#### Definition

```
#define SCROLLBAR_CI_THUMB    0
#define SCROLLBAR_CI_SHAFT   1
#define SCROLLBAR_CI_ARROW   2
```

#### Symbols

Definition	Description
<a href="#">SCROLLBAR_CI_THUMB</a>	Color of thumb area.
<a href="#">SCROLLBAR_CI_SHAFT</a>	Color of shaft.
<a href="#">SCROLLBAR_CI_ARROW</a>	Color of arrows.

### 7.2.26.5.2 SCROLLBAR create flags

#### Description

These flags can be used when creating a SCROLLBAR widget via `SCROLLBAR_CreateEx()`. These values can be OR-combined.

#### Definition

```
#define SCROLLBAR_CF_VERTICAL      (1 << 3)
#define SCROLLBAR_CF_FOCUSABLE   (1 << 4)
```

#### Symbols

Definition	Description
<a href="#">SCROLLBAR_CF_VERTICAL</a>	Creates a vertical SCROLLBAR widget.
<a href="#">SCROLLBAR_CF_FOCUSABLE</a>	Creates a focusable SCROLLBAR widget.

## 7.2.26.6 Example

The `Sample` folder contains the following example which shows how the widget can be used:

- `WIDGET_ScrollbarMove.c`

Note that several other examples also make use of this widget and may also be helpful to get familiar with the widget.

### Screenshot of `WIDGET_ScrollbarMove.c`

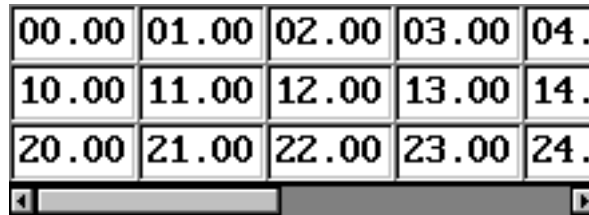

The screenshot displays a widget with a table of numbers and a scrollbar below it. The table has three rows and five columns. The numbers in the table are: 00.00, 01.00, 02.00, 03.00, 04. in the first row; 10.00, 11.00, 12.00, 13.00, 14. in the second row; and 20.00, 21.00, 22.00, 23.00, 24. in the third row. Below the table is a horizontal scrollbar with a left arrow and a right arrow.

00.00	01.00	02.00	03.00	04.
10.00	11.00	12.00	13.00	14.
20.00	21.00	22.00	23.00	24.

### 7.2.27 SCROLLER: Scroll widget

The SCROLLER widget is a newer version of the SCROLLBAR with a more modern UI.

SCROLLERS are used to indicate the scrolling position in a window with scrollable content. This especially makes sense if motion scrolling is enabled. Also, they can optionally be used to scroll through the window the SCROLLER is attached to.

A SCROLLER is typically attached to an existing window or widget, as shown below:

Name	First Name	Ext.	Title	Email
erson	Leslie	x4065	Sales Rep	lthompson@classicmodelcars.com
li	Julie	x2173	Sales Rep	jfirrelli@classicmodelcars.com
erson	Steve	x4334	Sales Rep	spatterson@classicmodelcars.com
g	Foon Yue	x2248	Sales Rep	ftseng@classicmodelcars.com
hy	Diane	x5800	President	dmurphy@classicmodelcars.com
erson	Mary	x4611	VP Sales	mpatterson@classicmodelcars.com
li	Jeff	x9273	VP Marketing	jfirrelli@classicmodelcars.com
erson	William	x4871	Sales Manager (APAC)	wpatterson@classicmodelcars.com
ur	Gerard	x5408	Sale Manager (EMEA)	gbondur@classicmodelcars.com
	Anthony	x5428	Sales Manager (NA)	abow@classicmodelcars.com
ngs	Leslie	x3291	Sales Rep	ljennings@classicmodelcars.com
erson	Leslie	x4065	Sales Rep	lthompson@classicmodelcars.com
li	Julie	x2173	Sales Rep	jfirrelli@classicmodelcars.com
erson	Steve	x4334	Sales Rep	spatterson@classicmodelcars.com
g	Foon Yue	x2248	Sales Rep	ftseng@classicmodelcars.com
hy	Diane	x5800	President	dmurphy@classicmodelcars.com
erson	Mary	x4611	VP Sales	mpatterson@classicmodelcars.com
li	Jeff	x9273	VP Marketing	jfirrelli@classicmodelcars.com
erson	William	x4871	Sales Manager (APAC)	wpatterson@classicmodelcars.com
ur	Gerard	x5408	Sale Manager (EMEA)	gbondur@classicmodelcars.com

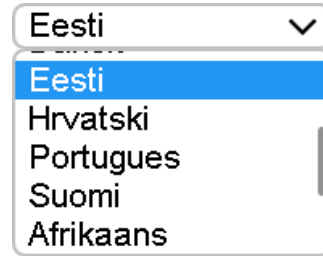

SCROLLERS may be created horizontally or vertically.

SCROLLERS can be attached to certain emWin widgets that have scrollable content and attaching to custom widgets is also possible, as described further below.

#### Note

All SCROLLER-related routines are located in the file(s) SCROLLER\*.c, SCROLLER.h. All identifiers are prefixed SCROLLER.

### 7.2.27.1 Structure of the SCROLLER widget

The following diagram shows the detailed structure and look of the SCROLLER widget:

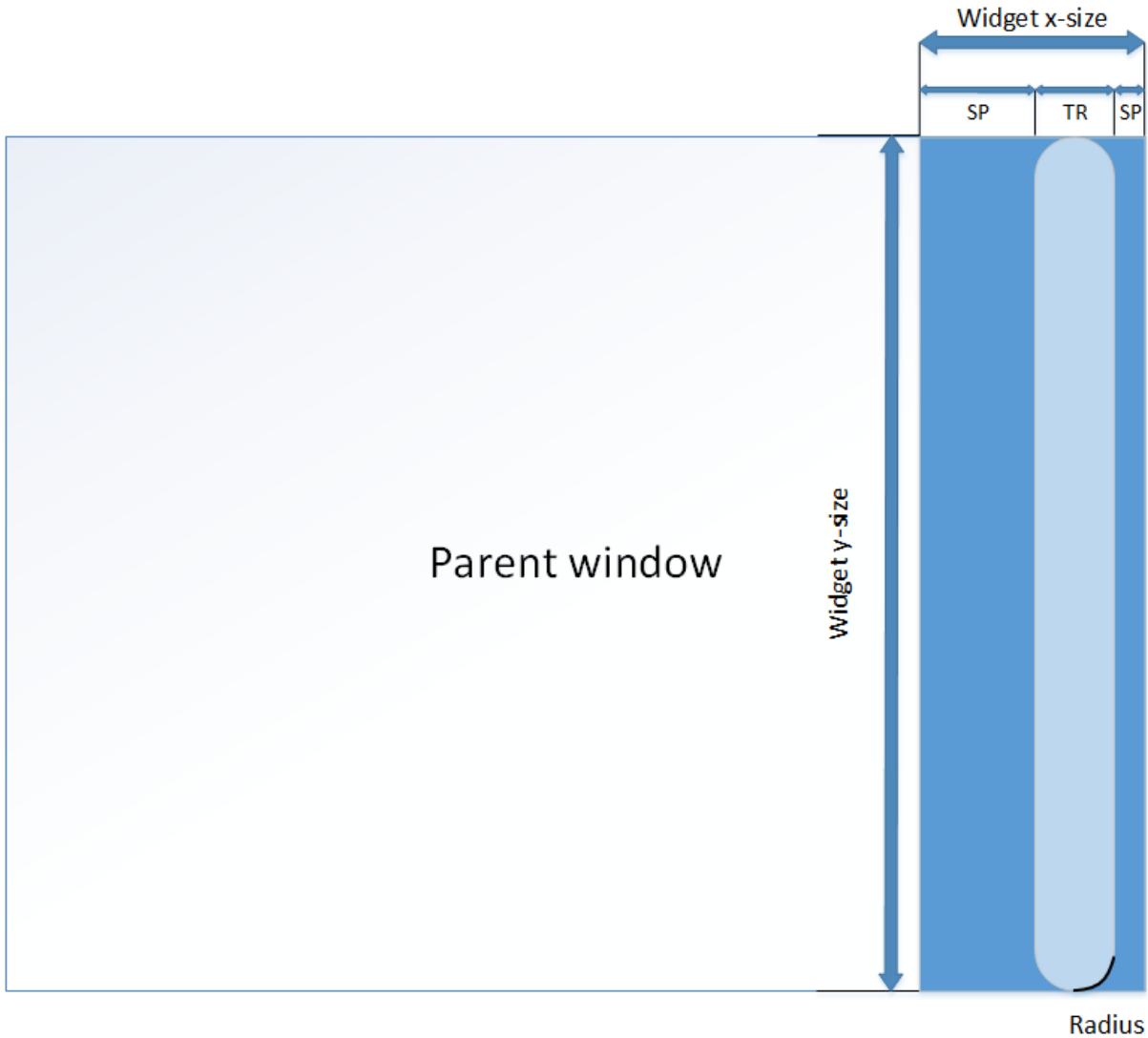

Details	Description
SP	Spacing, can be set with <code>SCROLLER_SetSpacing()</code> .
TR	Width of thumb rectangle, can be set with <code>SCROLLER_SetSize()</code> .
Widget x-size	The SCROLLER widget's x-size is the result of <code>SP + TR</code> .
Widget y-size	The SCROLLER widget's y-size is the y-size of the parent window's content rectangle. The content rectangle can be retrieved using <code>WM_GetContentRectEx()</code> .
Radius	The radius of the thumb rectangle, can be set with <code>SCROLLER_SetRadius()</code> .
Parent window	Parent window the SCROLLER is attached to.

#### Horizontal SCROLLERS

The above diagram is analogous for horizontal SCROLLERS, except that

- TR is the height of the thumb rectangle instead.
- How the widget's x-size and y-size are defined is inverted.



## 7.2.27.2 Configuration options

Type	Macro	Default	Description
N	SCROLLER_COLOR_ACTIVE_DEFAULT	GUI_MAKE_COLOR(0x50606060)	Color of the SCROLLER in its active state.
N	SCROLLER_COLOR_INACTIVE_DEFAULT	GUI_MAKE_COLOR(0x50AAAAAA)	Color of the SCROLLER in its inactive state.
N	SCROLLER_BKCOLOR_ACTIVE_DEFAULT	GUI_TRANSPARENT	Background color of the SCROLLER in its active state.
N	SCROLLER_BKCOLOR_INACTIVE_DEFAULT	GUI_TRANSPARENT	Background color of the SCROLLER in its inactive state.
N	SCROLLER_RADIUS_DEFAULT	3	Radius of the rounded rectangle.
N	SCROLLER_SIZE_DEFAULT	6	<b>Horizontal SCROLLER:</b> Height of the thumb rectangle. <b>Vertical SCROLLER:</b> Width of the thumb rectangle.
N	SCROLLER_SPACING_DEFAULT	24	Spacing to be added to be SCROLLER widget area.
N	SCROLLER_FADE_IN_PERIOD_DEFAULT	200	Period for fading in, from inactive to active state.
N	SCROLLER_FADE_OUT_PERIOD_DEFAULT	200	Period for fading out, from active to inactive state.
N	SCROLLER_INACTIVE_PERIOD_DEFAULT	200	Timer period for when the SCROLLER should become inactive after it stopped moving or has been released.
N	SCROLLER_ANIM_PERIOD_DEFAULT	150	Duration of scrolling animation.
N	SCROLLER_ANIM_EASE_FADE_DEFAULT	ANIM_ACCELDECEL	Animation ease to be used for the fading animation.
N	SCROLLER_ANIM_EASE_SCROLL_DEFAULT	ANIM_ACCELDECEL	Animation ease to be used for the scrolling animation.
N	SCROLLER_ALIGNMENT_WIDGETPOS_DEFAULT	(GUI_ALIGN_RIGHT   GUI_ALIGN_BOTTOM)	Alignment of the SCROLLER within the parent widget.
N	SCROLLER_ALIGNMENT_THUMB_DEFAULT	(GUI_ALIGN_RIGHT   GUI_ALIGN_BOTTOM)	Alignment of the thumb rectangle within the SCROLLER window.
N	SCROLLER_ALIGNMENT_OFFSET_DEFAULT	-3	Offset to SCROLLER_ALIGNMENT_THUMB_DEFAULT.
N	SCROLLER_THUMB_SIZE_MIN_DEFAULT	10	<b>Horizontal SCROLLER:</b> Minimum width of the thumb rectangle. <b>Vertical SCROLLER:</b> Minimum height of the thumb rectangle.

## 7.2.27.3 Predefined IDs

The following symbols define IDs which may be used to make SCROLLER widgets distinguishable from creation.

```
#define GUI_ID_SCROLLER0    0x380
#define GUI_ID_SCROLLER1    0x381
#define GUI_ID_SCROLLER2    0x382
#define GUI_ID_SCROLLER3    0x383
#define GUI_ID_SCROLLER4    0x384
```

```
#define GUI_ID_SCROLLER5    0x385
#define GUI_ID_SCROLLER6    0x386
#define GUI_ID_SCROLLER7    0x387
#define GUI_ID_SCROLLER8    0x388
#define GUI_ID_SCROLLER9    0x389
```

When a SCROLLER is attached to another window, the following IDs are used, based on whether the SCROLLER is vertical or horizontal.

```
#define GUI_ID_VSCROLLER    0xFFE
#define GUI_ID_HSCROLLER    0xFFF
```

### 7.2.27.4 Notification codes

The following events are sent from a SCROLLER widget to its parent window as part of a WM\_NOTIFY\_PARENT message:

Message	Description
WM_NOTIFICATION_CLICKED	SCROLLER has been clicked (only sent if touch mode is active).
WM_NOTIFICATION_RELEASED	SCROLLER has been released (only sent if touch mode is active).
WM_NOTIFICATION_SCROLLER_ADDED	SCROLLER has just been added (attached) to an existing window. The window is notified so that it can initialize the SCROLLER.
WM_NOTIFICATION_VALUE_CHANGED	Value of SCROLLER has been changed.

### 7.2.27.5 Widget behavior

#### Widget states

The SCROLLER is in active state during scrolling and in inactive state when it is not being moved. Both states have their own color.

Most interactions that alter the scrolling position of the SCROLLER's parent widget set the SCROLLERs state to active to indicate the scrolling movement. This can be one of the following movements:

- Motion swiping
- Scrolling by touching the SCROLLER widget itself
- Scrolling by key movements

When the SCROLLER has entered the active state by touch or motion scrolling, it will stay in the active state as long as the touch is not released.

#### Inactive timer

When the touch has been released or movement has stopped, after a given delay the SCROLLER will fade back into the inactive state. This delay can be set with SCROLLER\_SetPeriod() and the period index SCROLLER\_PI\_INACTIVE.

#### Fading

The widget can fade between the active and inactive state. This can be enabled or disabled with SCROLLER\_EnableFade(), or by passing the flag SCROLLER\_CF\_FADING when creating the widget. The fading period can be set using SCROLLER\_SetPeriod() with the period index SCROLLER\_PI\_FADE.

#### Touch input

If touch input is not enabled, the SCROLLER simply acts as an indicator widget that displays the current scroll state. Any touch input gets sent to the below parent widget.

Alternatively, touch can be activated which allows for quick scrolling through the parent's content. Touch can be enabled or disabled by calling `SCROLLER_EnableTouch()` or by passing the flag `SCROLLER_CF_TOUCH` when creating the `SCROLLER`.

When touch is enabled and the user touches outside the thumb rectangle, the thumb and scroll state will be animated to the given position in a given amount of time. The time for this scrolling animation can be set with `SCROLLER_SetPeriod()` and the period index `SCROLLER_PI_ANIM_SCROLL`.

The thumb rectangle can also be clicked and dragged to a new position.

### Automatic resizing

If a vertical and horizontal `SCROLLER` are added to a widget and both have touch input active, one `SCROLLER` will be resized so that there are no conflicts between the two touch areas. This is explained in more detail under `SCROLLER_EnableAutoResize()`.

## 7.2.27.6 Attaching SCROLLERS to widgets

The `SCROLLER` can be attached to all widgets, that provide native motion support. This is typically indicated when the given widget has a routine `<WIDGET>_EnableMotion()`. `SCROLLERS` can be attached to the following widgets:

- DROPDOWN
- LISTBOX
- LISTVIEW
- MULTIEDIT
- SWIPELIST

### Attaching a SCROLLER

A `SCROLLER` can be attached to any of the above mentioned widgets using `SCROLLER_CreateAttached()`.

```
hListview = LISTVIEW_CreateEx(0, 0, LCD_GetXSize(), LCD_GetYSize(), WM_HBKWIN,
                             WM_CF_SHOW, 0, GUI_ID_LISTVIEW0);
LISTVIEW_EnableMotion(hListview, LISTVIEW_CF_MOTION_V);
hScroller = SCROLLER_CreateAttached(hListview, SCROLLER_CF_VERTICAL |
                                     SCROLLER_CF_FADING |
                                     SCROLLER_CF_TOUCH);
```

### Overwritten callbacks

When a custom callback is used for one of the above mentioned widgets, it should be made sure that the custom callback calls the widget's default callback for all messages that are not handled by the custom callback, as well as all unhandled `WM_NOTIFY_PARENT` notifications.

## 7.2.27.7 Attaching SCROLLERS to custom widgets

Before a SCROLLER widget can be attached to a custom widget or window, there are a few steps necessary. These steps are listed below.

### Widget requirements

The widget should store the scrolling information (for horizontal and/or vertical scrolling, as desired) in memory. The widget's content should obviously move based on this scrolling value.

For this, the structure `WM_SCROLL_STATE` can be used. All values should be in pixels. The structure contains the three required values to save the scrolling position:

- **v:** Current scrolling position in pixels.
- **NumItems:** Total number of pixels that can be scrolled through. E.g. for a scrollable list, this would be the height of the entire scrolling area in pixels, from top to bottom. If for example a list had ten items each with a height of 20px, then `NumItems` would be 200.
- **PageSize:** The size in pixels of one page. One page is the area that is visible at once, without scrolling.

### Widget interfacing

Now, a structure of the type `SCROLLER_INTERFACE_API` has to be filled. This structure contains four functions required for the interfacing between the SCROLLER and the custom parent widget:

- **pfUpdateScrollPos():** The scroll state was changed by the parent and the new state is set to the SCROLLER.
- **pfValueChanged():** The SCROLLER changed the scroll state and the new state is set to the parent.
- **pfScrollerAdded():** Called when the SCROLLER is added to the parent widget, can be used to set SCROLLER or window properties.
- **pfGetContentRect():** Returns the content rectangle which is the scrollable area within the parent widget. The SCROLLER's size and position are derived from the content rectangle.

### pfUpdateScrollPos()

The function `pfUpdateScrollPos` should set the current scroll state that is saved in the parent widget to the SCROLLER widget. This can be done like this:

```

/*****
*
*     _UpdateScrollPos
*/
static void _UpdateScrollPos(WM_HWIN hParent, SCROLLER_Handle hScroller) {
    WM_SCROLL_STATE State;

    //
    // Retrieve scroll state from parent widget...
    //
    PARENT_GetScrollState(hParent, &State);
    //
    // Set the scroll state to SCROLLER
    //
    SCROLLER_SetScrollState(hScroller, &State);
}

```

## pfValueChanged()

The function `pfValueChanged` is called when the SCROLLER sends a `WM_NOTIFICATION_VALUE_CHANGED` notification to its parent widget. The parameter `pNewState` contains the new scroll state. The function should set this scroll state to the parent widget. Optionally, the scroll state can be manipulated, before it is set.

```

/*****
 *
 *      _OnValueChanged
 */
static void _OnValueChanged(WM_HWIN hParent, SCROLLER_Handle hScroller, WM_SCROLL_STATE * pNewState) {
    GUI_USE_PARA(hScroller);
    //
    // Set new scroll state to parent and redraw parent.
    //
    PARENT_SetScrollState(pNewState);
    WM_InvalidateWindow(hParent);
}

```

## pfScrollerAdded()

The function `pfScrollerAdded()` gets called right after the SCROLLER has been created and attached to the parent widget. In this function, the parent window should check if the size of the content actually justifies the use of SCROLLERS. If e.g. a list is too short to scroll through, the SCROLLER can be hidden at this point. Below is an example implementation.

```

/*****
 *
 *      _OnScrollerAdded
 */
static void _OnScrollerAdded(WM_HWIN hParent, SCROLLER_Handle hScroller) {
    WM_HWIN hScroller;
    U8      IsRequired;
    int     ListSize;
    int     ySize;

    ySize      = WM_GetYSize(hParent);
    ListSize   = PARENT_GetListSize(hParent);
    IsRequired = (ListSize > ySize) ? 1 : 0;
    if (IsRequired) {
        WM_ShowWindow(hScroller);
    } else {
        WM_HideWindow(hScroller);
    }
}

```

## pfGetContentRect()

The function `pfGetContentRect()` gets called when the parent window receives a `WM_GET_CONTENT_RECT` message. In this function, the parent window should return its content rectangle in client coordinates. The attached SCROLLER's position and size will be derived from the content rectangle.

```

/*****
 *
 *      _GetContentRect
 */
static void _GetContentRect(WM_HWIN hParent, GUI_RECT * pRect) {
    //
    // Reduce client rectangle by 20px on all vertices.
    //
    WM_GetClientRectEx(hParent, pRect);
    GUI_AddRect(pRect, pRect, -20);
}

```

If the content rectangle should be the same as the window's client rectangle, the entry in `SCROLLER_INTERFACE_API` can be left as `NULL`, so that the `WM_GET_CONTENT_RECT` message will be handled by `WM_DefaultProc()`.

### Add the message handler to the parent widget's callback

Now, the message handler `SCROLLER_ParentMsgHandler()` has to be added to the parent window's callback. It has to be made sure of that the following messages are passed to this handler **after** they have been processed by the parent window's callback, but **before** they are being passed to `WM_DefaultProc()`.

- `WM_MOTION` message
- `WM_NOTIFY_PARENT` message with the notifications `WM_NOTIFICATION_VALUE_CHANGED` and `WM_NOTIFICATION_SCROLLER_ADDED`.
- `WM_GET_CONTENT_RECT`

This can be ensured by a callback structure like shown below. If `SCROLLER_ParentMsgHandler()` does not handle the given message, the routine will return 1.

```

/*****
 *
 *      _cb
 */
static void _cb(WM_MESSAGE * pMsg) {
    switch (pMsg->MsgId) {
        //
        // Handle messages.
        // No 'return' statements in the messages WM_MOTION, WM_NOTIFY_PARENT
        // and WM_GET_CONTENT_RECT before SCROLLER_ParentMsgHandler() is called.
        //
        ...
    }
    //
    // Send messages also to the SCROLLER's message handler.
    //
    if (SCROLLER_ParentMsgHandler(pMsg)) {
        WM_DefaultProc(pMsg);
    }
}

```

### Overlap (optional)

If the parent window has motion support active and uses an overlapping value for swiping, two things have to be observed:

- The overlap value has to be set to the `Overlap` element of the `WM_MOTION_INFO` structure sent with the `WM_MOTION` message to the parent window.
- During swiping, the parent window has to set its pixelbased scroll state according to the overlap value. This means for example, if the overlapping area is entered at the top, e.g. by 10 px, then the scroll state should be set to -10. And vice versa, if the overlapping area at the bottom is entered, the overlapped distance is added to the scroll state.

### Manually set the active state (optional)

In some cases it can make sense if the parent widget also manually controls the `SCROLLER`'s active state. This can e.g. be desirable when the parent widget's scroll state can be changed by key inputs and the `SCROLLER` should change its visual state during this event.

To do so, the routine `SCROLLER_SetState()` can be used to manually set the desired state.

## Attach SCROLLER to custom widget

After all these steps have been executed properly, the given widget supports the use of SCROLLER widgets. Now, a SCROLLER widget can be attached to the window and the interface API can be set.

```
static const SCROLLER_INTERFACE_API _InterfaceAPI = {
    _UpdateScrollPos,    // pfUpdateScrollPos
    _OnScrollerAdded,   // pfScrollerAdded
    _OnValueChanged,   // pfValueChanged
    _GetContentRect,    // pfGetContentRect
};

WM_HWIN hParent;
WM_HWIN hScroller;

hScroller = SCROLLER_CreateAttached(hParent, SCROLLER_CF_VERTICAL);
SCROLLER_SetInterfaceAPI(hScroller, &_InterfaceAPI);
```

## 7.2.27.8 SCROLLER API

The table below lists the available emWin SCROLLER-related routines in alphabetical order. Detailed descriptions of the routines follow.

### Functions

Routine	Description
<code>SCROLLER_AttachToWindow()</code>	Attaches the given SCROLLER to a new parent window.
<code>SCROLLER_CreateAttached()</code>	Creates a scroll bar which is attached to an existing window.
<code>SCROLLER_CreateIndirect()</code>	Creates a SCROLLER widget from a resource table entry.
<code>SCROLLER_CreateUser()</code>	Creates a SCROLLER widget of a specified size at a specified location and allocates a given number of additional bytes.
<code>SCROLLER_EnableAutoResize()</code>	Enables or disables automatic resizing of SCROLLER widgets.
<code>SCROLLER_EnableFade()</code>	Enables or disables fading mode for the SCROLLER widget.
<code>SCROLLER_EnableTouch()</code>	Enables or disables touch input for the SCROLLER widget.
<code>SCROLLER_GetAlign()</code>	Returns the given alignment set to the SCROLLER widget.
<code>SCROLLER_GetAlignOffset()</code>	Returns the alignment offset set to the SCROLLER rectangle.
<code>SCROLLER_GetAnimEase()</code>	Returns the animation ease for a given animation of the SCROLLER.
<code>SCROLLER_GetBkColor()</code>	Returns the background color of the SCROLLER widget.
<code>SCROLLER_GetColor()</code>	Returns the given color of the SCROLLER widget.
<code>SCROLLER_GetDefaultAlign()</code>	Returns the given default alignment for SCROLLER widgets.
<code>SCROLLER_GetDefaultAlignOffset()</code>	Returns the default alignment offset for newly created SCROLLER widgets.
<code>SCROLLER_GetDefaultAnimEase()</code>	Returns the default animation ease for a given animation for SCROLLER widgets.
<code>SCROLLER_GetDefaultBkColor()</code>	Returns the default background color of the SCROLLER widget.
<code>SCROLLER_GetDefaultColor()</code>	Returns the given default color for SCROLLER widgets.
<code>SCROLLER_GetDefaultPeriod()</code>	Returns the given default period for SCROLLER widgets.
<code>SCROLLER_GetDefaultRadius()</code>	Returns the default radius used for SCROLLER widgets.
<code>SCROLLER_GetDefaultThumbSizeMin()</code>	Returns the default minimum thumb size used for SCROLLER widgets.
<code>SCROLLER_GetDefaultSize()</code>	Returns the default width/height used for the SCROLLER rectangle.
<code>SCROLLER_GetDefaultSpacing()</code>	Returns the default spacing used for newly created SCROLLER widgets.



Routine	Description
<code>SCROLLER_GetPeriod()</code>	Returns the given period of the SCROLLER widget.
<code>SCROLLER_GetRadius()</code>	Returns the radius of the SCROLLER widget.
<code>SCROLLER_GetScrollState()</code>	Retrieves the current scroll state of the SCROLLER.
<code>SCROLLER_GetSize()</code>	Returns the thickness of the SCROLLER thumb rectangle.
<code>SCROLLER_GetSpacing()</code>	Returns the spacing of the SCROLLER widget.
<code>SCROLLER_GetThumbRect()</code>	Returns the current thumb rectangle in coordinates relative to the SCROLLER.
<code>SCROLLER_GetThumbSizeMin()</code>	Returns the minimum thumb size of the SCROLLER widget.
<code>SCROLLER_GetUserData()</code>	Retrieves the extra data of a SCROLLER widget.
<code>SCROLLER_OwnerDraw()</code>	Default function for managing drawing operations of the SCROLLER widget.
<code>SCROLLER_ParentMsgHandler()</code>	Message handler called from the callback of the SCROLLER's parent widget.
<code>SCROLLER_PreventIntersect()</code>	Automatically limits the movement area both SCROLLERS if a widget has a vertical and horizontal SCROLLER attached.
<code>SCROLLER_SetAlign()</code>	Sets the given alignment of the SCROLLER.
<code>SCROLLER_SetAlignOffset()</code>	Sets the alignment offset to the SCROLLER rectangle in pixels.
<code>SCROLLER_SetAnimEase()</code>	Sets the animation ease for a given animation of the SCROLLER.
<code>SCROLLER_SetBkColor()</code>	Sets the background color of the SCROLLER widget.
<code>SCROLLER_SetColor()</code>	Sets the given color to the SCROLLER widget.
<code>SCROLLER_SetContentRect()</code>	Allows to set a custom rectangle that will be used to determine the size of the SCROLLER.
<code>SCROLLER_SetDefaultAlign()</code>	Set the given default alignment for newly created SCROLLER widgets.
<code>SCROLLER_SetDefaultAlignOffset()</code>	Set the default alignment offset for newly created SCROLLER widgets.
<code>SCROLLER_SetDefaultAnimEase()</code>	Sets the default animation ease for a given animation for SCROLLER widgets.
<code>SCROLLER_SetDefaultBkColor()</code>	Sets the default background color of the SCROLLER widget.
<code>SCROLLER_SetDefaultColor()</code>	Sets the given default color for newly created SCROLLER widgets.
<code>SCROLLER_SetDefaultPeriod()</code>	Sets the given default period for newly created SCROLLER widgets.
<code>SCROLLER_SetDefaultRadius()</code>	Sets the default radius for newly created SCROLLER widgets.

Routine	Description
<code>SCROLLER_SetDefaultThumbSizeMin()</code>	Sets the default minimum thumb size for newly created SCROLLER widgets.
<code>SCROLLER_SetDefaultSize()</code>	Sets the default width/height of the SCROLLER rectangle.
<code>SCROLLER_SetDefaultSpacing()</code>	Sets the default spacing used for newly created SCROLLER widgets.
<code>SCROLLER_SetInterfaceAPI()</code>	Sets the function pointers for the interface between the parent widget and the SCROLLER.
<code>SCROLLER_SetOwnerDraw()</code>	Sets an application defined owner draw function for the widget which is responsible for drawing the SCROLLER bar.
<code>SCROLLER_SetPeriod()</code>	Sets the given color to the SCROLLER widget.
<code>SCROLLER_SetRadius()</code>	Sets the radius of the SCROLLER widget.
<code>SCROLLER_SetScrollState()</code>	Sets the scroll state of the SCROLLER.
<code>SCROLLER_SetSize()</code>	Sets the thickness of the SCROLLER thumb rectangle.
<code>SCROLLER_SetSpacing()</code>	Sets the spacing for the SCROLLER widget.
<code>SCROLLER_SetState()</code>	Manually sets the state of the SCROLLER to active or inactive.
<code>SCROLLER_SetThumbSizeMin()</code>	Sets the minimum thumb size for the SCROLLER widget.
<code>SCROLLER_SetUserData()</code>	Sets the extra data of a SCROLLER widget.

## Data structures

Structure	Description
<code>SCROLLER_INTERFACE_API</code>	Interface API between the SCROLLER and its parent widget.

## Defines

Group of defines	Description
<code>SCROLLER alignment indexes</code>	Alignment indexes for SCROLLER widgets.
<code>SCROLLER animation indexes</code>	Animation indexes used for <code>SCROLLER_SetAnimEase()</code> .
<code>SCROLLER color indexes</code>	Color indexes for SCROLLER widgets.
<code>SCROLLER create flags</code>	Create flags for SCROLLER widgets.
<code>SCROLLER period indexes</code>	Period indexes for SCROLLER widgets.

## 7.2.27.8.1 Functions

### 7.2.27.8.1.1 SCROLLER\_AttachToWindow()

#### Description

Attaches the given SCROLLER to a new parent window. The SCROLLER is resized according to new parent window.

#### Prototype

```
void SCROLLER_AttachToWindow(SCROLLER_Handle hObj,  
                             WM_HWIN        hNewParent);
```

#### Parameters

Parameter	Description
<code>hObj</code>	Handle of SCROLLER widget.
<code>hNewParent</code>	Handle of new parent window.

#### Additional information

The new parent window will receive a `WM_NOTIFY_PARENT` message with `WM_NOTIFICATION_SCROLLER_ADDED` as the notification ID.

### 7.2.27.8.1.2 SCROLLER\_CreateAttached()

#### Description

Creates a scroll bar which is attached to an existing window.

#### Prototype

```
SCROLLER_Handle SCROLLER_CreateAttached(WM_HWIN hParent,
                                         int      ExFlags);
```

#### Parameters

Parameter	Description
<code>hParent</code>	Handle of parent window.
<code>ExFlags</code>	Special creation flags. Permitted values are listed under <i>SCROLLER create flags</i> on page 2291.

#### Return value

- = 0      Creation of the SCROLLER failed e.g. because the parent widget already has a SCROLLER with the same orientation attached.
- ≠ 0     Handle of the created SCROLLER widget.

#### Additional information

An attached SCROLLER widget is essentially a child window which will position itself on the parent window and operate accordingly.

Vertically attached SCROLLER widgets will be automatically placed on the right side of the parent window; horizontal SCROLLER widgets on the bottom. Since no more than one horizontal and one vertical SCROLLER widget can be attached to a parent window, no ID needs to be passed as parameter. The following fixed ID's will automatically be assigned when an attached SCROLLER widget is created:

- `GUI_ID_HSCROLLER` for a horizontal SCROLLER widget
- `GUI_ID_VSCROLLER` for a vertical SCROLLER widget

### 7.2.27.8.1.3 SCROLLER\_CreateIndirect()

#### Description

Prototype explained at the beginning of the chapter as `<WIDGET>_CreateIndirect()` on page 1161.

### 7.2.27.8.1.4 SCROLLER\_CreateUser()

#### Description

Creates a SCROLLER widget of a specified size at a specified location and allocates a given number of additional bytes.

#### Prototype

```
SCROLLER_Handle SCROLLER_CreateUser(int    x0,
                                     int    y0,
                                     int    xSize,
                                     int    ySize,
                                     WM_HWIN hParent,
                                     int    WinFlags,
                                     int    ExFlags,
                                     int    Id,
                                     int    NumExtraBytes);
```

#### Parameters

Parameter	Description
<code>x0</code>	Leftmost pixel of the widget (in parent coordinates).
<code>y0</code>	Topmost pixel of the widget (in parent coordinates).
<code>xSize</code>	Horizontal size of the widget (in pixels).
<code>ySize</code>	Vertical size of the widget (in pixels).
<code>hParent</code>	Handle of parent window. If 0, the new SCROLLER widget will be a child of the desktop (top-level window).
<code>WinFlags</code>	Window create flags. Typically <code>WM_CF_SHOW</code> in order to make the widget visible immediately (refer to <i>Window create flags</i> on page 1146 for a list of available parameter values).
<code>ExFlags</code>	OR-combination of special creation flags. See <i>SCROLLER create flags</i> on page 2291 for a list of permitted values.
<code>Id</code>	Window ID of the widget.
<code>NumExtraBytes</code>	Number of extra bytes to be allocated.

#### Return value

- = 0      Creation of the SCROLLER failed e.g. because the parent widget already has a SCROLLER with the same orientation attached.
- ≠ 0      Handle of the created SCROLLER widget.

### 7.2.27.8.1.5 SCROLLER\_EnableAutoResize()

#### Description

Enables or disables automatic resizing of SCROLLER widgets.

Automatic resizing will come into effect if the two touch areas of a horizontal and vertical SCROLLER would collide. The two touch areas would only collide if the following is true:

- There is a vertical and horizontal SCROLLER attached to the parent widget.
- Both SCROLLERS are visible and have touch input enabled.

According to the given paramters, automatic resizing can be enabled or disabled and the desired SCROLLER to be resized can be set.

#### Prototype

```
void SCROLLER_EnableAutoResize(int EnableAutoResize,
                                int Vertical);
```

#### Parameters

Parameter	Description
EnableAutoResize	1 for enabling, 0 for disabling.
Vertical	1 if vertical SCROLLER should be reduced in size, 0 if horizontal SCROLLER should be reduced in size.

#### Additional information

Automatic resizing is enabled by default. The default is that horizontal SCROLLERS will be reduced in size.

#### Example

The example below demonstrates how SCROLLERS are resized if auto resizing is enabled. The client area of the vertical SCROLLER is marked green while the horizontal SCROLLER is marked red.

Auto resize enabled for horizontal SCROLLER	Auto resize enabled for vertical SCROLLER	Auto resize disabled
<pre>SCROLLER_EnableAutoResize(1, 0);</pre>	<pre>SCROLLER_EnableAutoResize(1, 1);</pre>	<pre>SCROLLER_EnableAutoResize(0, 0);</pre>
The horizontal SCROLLER is reduced in size in favor of the vertical SCROLLER.	The vertical SCROLLER is reduced in size in favor of the horizontal SCROLLER.	Both SCROLLERS are not resized and the widgets overlap.

### 7.2.27.8.1.6 SCROLLER\_EnableFade()

#### Description

Enables or disables fading mode for the SCROLLER widget.

#### Prototype

```
void SCROLLER_EnableFade(SCROLLER_Handle hObj,  
                          U8 OnOff);
```

#### Parameters

Parameter	Description
<code>hObj</code>	SCROLLER handle.
<code>OnOff</code>	1 for enabling, 0 for disabling.



### 7.2.27.8.1.7 SCROLLER\_EnableTouch()

#### Description

Enables or disables touch input for the SCROLLER widget.

#### Prototype

```
void SCROLLER_EnableTouch(SCROLLER_Handle hObj,  
                           U8 OnOff);
```

#### Parameters

Parameter	Description
<code>hObj</code>	SCROLLER handle.
<code>OnOff</code>	1 for enabling, 0 for disabling.

### 7.2.27.8.1.8 SCROLLER\_GetAlign()

#### Description

Returns the given alignment set to the SCROLLER widget.

#### Prototype

```
U8 SCROLLER_GetAlign(SCROLLER_Handle hObj,  
                     unsigned int   AlignIndex);
```

#### Parameters

Parameter	Description
<a href="#">hObj</a>	SCROLLER handle.
<a href="#">AlignIndex</a>	See <i>SCROLLER alignment indexes</i> on page 2288 for a full list of permitted values.

#### Return value

≠ 0    Alignment set to SCROLLER widget.  
= 0    Error.

### 7.2.27.8.1.9 SCROLLER\_GetAlignOffset()

#### Description

Returns the alignment offset set to the SCROLLER rectangle.

#### Prototype

```
I16 SCROLLER_GetAlignOffset(SCROLLER_Handle hObj);
```

#### Parameters

Parameter	Description
<a href="#">hObj</a>	SCROLLER handle.

#### Return value

Alignment offset of the SCROLLER rectangle in pixels.

### 7.2.27.8.1.10 SCROLLER\_GetAnimEase()

#### Description

Returns the animation ease for a given animation of the SCROLLER. More detailed information about animation ease can be read in the chapter "Animations" under *Position calculation* on page 754.

#### Prototype

```
GUI_ANIM_GETPOS_FUNC SCROLLER_GetAnimEase(SCROLLER_Handle hObj,  
                                           unsigned int   AnimIndex);
```

#### Parameters

Parameter	Description
<a href="#">hObj</a>	Handle to a SCROLLER widget.
<a href="#">AnimIndex</a>	See <i>SCROLLER animation indexes</i> on page 2289.

#### Return value

= NULL    Invalid parameters.  
≠ NULL    Pointer to position calculation function.

### 7.2.27.8.1.11 SCROLLER\_GetBkColor()

#### Description

Returns the background color of the SCROLLER widget.

#### Prototype

```
GUI_COLOR SCROLLER_GetBkColor(SCROLLER_Handle hObj,  
                               unsigned int   ColorIndex);
```

#### Parameters

Parameter	Description
<a href="#">hObj</a>	Handle to a SCROLLER widget.
<a href="#">ColorIndex</a>	See <i>SCROLLER color indexes</i> on page 2290 for a full list of permitted values.

#### Return value

Returns the given background color of the SCROLLER widget.

### 7.2.27.8.1.12 SCROLLER\_GetColor()

#### Description

Returns the given color of the SCROLLER widget.

#### Prototype

```
GUI_COLOR SCROLLER_GetColor(SCROLLER_Handle hObj,  
                             unsigned int   ColorIndex);
```

#### Parameters

Parameter	Description
<code>hObj</code>	SCROLLER handle.
<code>ColorIndex</code>	See <i>SCROLLER color indexes</i> on page 2290 for a full list of permitted values.

#### Return value

Given color set to the SCROLLER widget.

### 7.2.27.8.1.13 SCROLLER\_GetDefaultAlign()

#### Description

Returns the given default alignment for SCROLLER widgets.

#### Prototype

```
U8 SCROLLER_GetDefaultAlign(unsigned int AlignIndex);
```

#### Parameters

Parameter	Description
<a href="#">AlignIndex</a>	See <i>SCROLLER alignment indexes</i> on page 2288 for a full list of permitted values.

#### Return value

≠ 0     The given default alignment for SCROLLER widgets.  
= 0     Error.

#### 7.2.27.8.1.14 SCROLLER\_GetDefaultAlignOffset()

##### Description

Returns the default alignment offset for newly created SCROLLER widgets.

##### Prototype

```
I16 SCROLLER_GetDefaultAlignOffset(void);
```

##### Return value

Default alignment offset.



### 7.2.27.8.1.15 SCROLLER\_GetDefaultAnimEase()

#### Description

Returns the default animation ease for a given animation for SCROLLER widgets.

#### Prototype

```
GUI_ANIM_GETPOS_FUNC SCROLLER_GetDefaultAnimEase(unsigned int AnimIndex);
```

#### Parameters

Parameter	Description
<a href="#">AnimIndex</a>	See <i>SCROLLER animation indexes</i> on page 2289.

#### Return value

- = NULL Invalid parameters.
- ≠ NULL Pointer to position calculation function.

### 7.2.27.8.1.16 SCROLLER\_GetDefaultBkColor()

#### Description

Returns the default background color of the SCROLLER widget.

#### Prototype

```
GUI_COLOR SCROLLER_GetDefaultBkColor(unsigned int ColorIndex);
```

#### Parameters

Parameter	Description
<code>ColorIndex</code>	See <i>SCROLLER color indexes</i> on page 2290 for a full list of permitted values.

#### Return value

≠ GUI\_INVALID\_COLOR      Default background color.  
= GUI\_INVALID\_COLOR      Error.

### 7.2.27.8.1.17 SCROLLER\_GetDefaultColor()

#### Description

Returns the given default color for SCROLLER widgets.

#### Prototype

```
GUI_COLOR SCROLLER_GetDefaultColor(unsigned int ColorIndex);
```

#### Parameters

Parameter	Description
<code>ColorIndex</code>	See <i>SCROLLER color indexes</i> on page 2290 for a full list of permitted values.

#### Return value

≠ GUI\_INVALID\_COLOR      The given default color for SCROLLER widgets.  
= GUI\_INVALID\_COLOR      Error.

### 7.2.27.8.1.18 SCROLLER\_GetDefaultPeriod()

#### Description

Returns the given default period for SCROLLER widgets.

#### Prototype

```
int SCROLLER_GetDefaultPeriod(unsigned int PeriodIndex);
```

#### Parameters

Parameter	Description
<a href="#">PeriodIndex</a>	See <i>SCROLLER period indexes</i> on page 2292 for a full list of permitted values.

#### Return value

≠ -1 The given default period for SCROLLER widgets.  
= -1 Error.

### 7.2.27.8.1.19 SCROLLER\_GetDefaultRadius()

#### Description

Returns the default radius used for SCROLLER widgets.

#### Prototype

```
I16 SCROLLER_GetDefaultRadius(void);
```

#### Return value

Default radius for SCROLLER widgets.

### 7.2.27.8.1.20 SCROLLER\_GetDefaultThumbSizeMin()

#### Description

Returns the default minimum thumb size used for SCROLLER widgets.

#### Prototype

```
I16 SCROLLER_GetDefaultThumbSizeMin(void);
```

#### Return value

Default minimum thumb size used for SCROLLER widgets.

### 7.2.27.8.1.21 SCROLLER\_GetDefaultSize()

#### Description

Returns the default width/height used for the SCROLLER rectangle. This depends on whether the widget is vertical or horizontal.

#### Prototype

```
I16 SCROLLER_GetDefaultSize(void);
```

#### Return value

- Default width for the SCROLLER rectangle (if the widget is vertical).
- Default height for the SCROLLER rectangle (if the widget is horizontal).

### 7.2.27.8.1.22 SCROLLER\_GetDefaultSpacing()

#### Description

Returns the default spacing used for newly created SCROLLER widgets.

The spacing and thumb size are added to determine the overall height (if the SCROLLER is horizontal) or the overall width (if the SCROLLER is vertical) and therefore the touch area of the widget.

#### Prototype

```
I16 SCROLLER_GetDefaultSpacing(void);
```

#### Return value

Default spacing used for SCROLLER widgets.



### 7.2.27.8.1.23 SCROLLER\_GetPeriod()

#### Description

Returns the given period of the SCROLLER widget.

#### Prototype

```
int SCROLLER_GetPeriod(SCROLLER_Handle hObj,  
                        unsigned int   PeriodIndex);
```

#### Parameters

Parameter	Description
<a href="#">hObj</a>	SCROLLER handle.
<a href="#">PeriodIndex</a>	See <i>SCROLLER period indexes</i> on page 2292 for a full list of permitted values.

#### Return value

≠ -1 The given period in ms of the SCROLLER widget.  
= -1 Error.

### 7.2.27.8.1.24 SCROLLER\_GetRadius()

#### Description

Returns the radius of the SCROLLER widget.

#### Prototype

```
I16 SCROLLER_GetRadius(SCROLLER_Handle hObj);
```

#### Parameters

Parameter	Description
<a href="#">hObj</a>	SCROLLER handle.

#### Return value

≠ -1     Radius of the SCROLLER widget.  
= -1     Error.

### 7.2.27.8.1.25 SCROLLER\_GetScrollState()

#### Description

Retrieves the current scroll state of the SCROLLER. Under normal circumstances, this routine does not have to be called as the scroll state should be set automatically.

#### Parameters

Parameter	Description
<code>hObj</code>	Handle to a SCROLLER widget.
<code>pState</code>	<code>out</code> New scroll state.

### 7.2.27.8.1.26 SCROLLER\_GetSize()

#### Description

Returns the thickness of the SCROLLER thumb rectangle. Size refers to the width of the SCROLLER rectangle if the widget is vertical or height of the rectangle if the widget is horizontal.

#### Prototype

```
I16 SCROLLER_GetSize(SCROLLER_Handle hObj);
```

#### Parameters

Parameter	Description
<a href="#">hObj</a>	SCROLLER handle.

#### Return value

≠ -1    Size of the SCROLLER widget.  
= -1    Error.

### 7.2.27.8.1.27 SCROLLER\_GetSpacing()

#### Description

Returns the spacing of the SCROLLER widget.

The spacing and thumb size are added to determine the overall height (if the SCROLLER is horizontal) or the overall width (if the SCROLLER is vertical) and therefore the touch area of the widget.

#### Prototype

```
I16 SCROLLER_GetSpacing(SCROLLER_Handle hObj);
```

#### Parameters

Parameter	Description
<a href="#">hObj</a>	Handle to a SCROLLER widget.

#### Return value

= -1     Error.  
≠ -1     Spacing of the SCROLLER.

### 7.2.27.8.1.28 SCROLLER\_GetThumbRect()

#### Description

Returns the current thumb rectangle in coordinates relative to the SCROLLER.

#### Prototype

```
void SCROLLER_GetThumbRect(SCROLLER_Handle hObj,  
                           GUI_RECT * pRect);
```

#### Parameters

Parameter	Description
<code>hObj</code>	Handle to a SCROLLER widget.
<code>pRect</code>	<code>out</code> Pointer to a GUI_RECT structure.

### 7.2.27.8.1.29 SCROLLER\_GetThumbSizeMin()

#### Description

Returns the minimum thumb size of the SCROLLER widget. Thumb size refers to the SCROLLER rectangle length if the widget is horizontal and the rectangle height if the widget is vertical.

#### Prototype

```
I16 SCROLLER_GetThumbSizeMin(SCROLLER_Handle hObj);
```

#### Parameters

Parameter	Description
<a href="#">hObj</a>	SCROLLER handle.

#### Return value

≠ -1 Minimum thumb size of the SCROLLER widget.  
= -1 Error.

### 7.2.27.8.1.30 SCROLLER\_GetUserData()

#### Description

Prototype explained at the beginning of the chapter as `<WIDGET>_GetUserData()` on page 1165.



### 7.2.27.8.1.31 SCROLLER\_OwnerDraw()

#### Description

Default function for managing drawing operations of the SCROLLER widget.

#### Prototype

```
int SCROLLER_OwnerDraw(const WIDGET_ITEM_DRAW_INFO * pDrawItemInfo);
```

#### Parameters

Parameter	Description
<code>pDrawItemInfo</code>	<b>in</b> Pointer to a <code>WIDGET_ITEM_DRAW_INFO</code> structure.

#### Return value

Depends on the command in the `Cmd` element of the `WIDGET_ITEM_DRAW_INFO` structure pointed to by `pDrawItemInfo`.

#### Additional information

This function is useful if `SCROLLER_SetOwnerDraw()` is used. It can be used to draw the thumb and background of the widget manually.

The following commands are managed by the default function (in the order of calling):

- `WIDGET_ITEM_DRAW_BACKGROUND`: Draws the background of the widget area.
- `WIDGET_ITEM_DRAW`: Draws the thumb.

#### WIDGET\_ITEM\_DRAW\_BACKGROUND

The following elements of the `WIDGET_ITEM_DRAW_INFO` structure are usable:

Element	Description
<code>hWin</code>	Handle of SCROLLER widget.
<code>x0</code>	x0 of the background rectangle.
<code>y0</code>	y0 of the background rectangle.
<code>x1</code>	x1 of the background rectangle.
<code>y1</code>	y1 of the background rectangle.
<code>ItemIndex</code>	-1 during fading animation, or color index which is listed under <i>SCROLLER color indexes</i> on page 2290.
<code>P</code>	Only if <code>ItemIndex = -1</code> (during fade animation): Pointer to an <code>I16</code> which contains the current animation position. This value ranges from 0 to <code>GUI_ANIM_RANGE</code> , while 0 equals the inactive state and <code>GUI_ANIM_RANGE</code> equals the active state.

#### WIDGET\_ITEM\_DRAW

The following elements of the `WIDGET_ITEM_DRAW_INFO` structure are usable:

Element	Description
<code>hWin</code>	Handle of SCROLLER widget.
<code>x0</code>	x0 of the thumb rectangle.*
<code>y0</code>	y0 of the thumb rectangle.*
<code>x1</code>	x1 of the thumb rectangle.*
<code>y1</code>	y1 of the thumb rectangle.*
<code>ItemIndex</code>	-1 during fading animation, or color index which is listed under <i>SCROLLER color indexes</i> on page 2290.

Element	Description
P	Only if ItemIndex = -1 (during fade animation): Pointer to an I16 which contains the current animation position. This value ranges from 0 to GUI_ANIM_RANGE, while 0 equals the inactive state and GUI_ANIM_RANGE equals the active state.

\* High resolution coordinates. In order to convert them to pixel coordinates, scale down by 4. To retrieve the thumb rectangle in pixel coordinates, the function `SCROLLER_GetThumbRect()` can also be used.

### 7.2.27.8.1.32 SCROLLER\_ParentMsgHandler()

#### Description

Message handler called from the callback of the SCROLLER's parent widget.

**Note:** This function is only to be called when custom widgets or windows should support SCROLLER widgets.

#### Prototype

```
int SCROLLER_ParentMsgHandler(WM_MESSAGE * pMsg);
```

#### Parameters

Parameter	Description
<code>pMsg</code>	<code>in</code> Pointer to WM_MESSAGE structure.

#### Return value

- 0 Message was handled.
- 1 Message was not handled.

#### Additional information

This routine handles the following messages:

- WM\_MOTION
- WM\_NOTIFY\_PARENT (WM\_NOTIFICATION\_SCROLLER\_ADDED and WM\_NOTIFICATION\_VALUE\_CHANGED).
- WM\_GET\_CONTENT\_RECT

**Important:** This message handler needs to be called **after** the parent widget's callback has handled the above messages. Also make sure that `WM_DefaultProc()` does not handle the messages first.

### 7.2.27.8.1.33 SCROLLER\_PreventIntersect()

#### Description

Automatically limits the movement area both SCROLLERS if a widget has a vertical and horizontal SCROLLER attached. This will prevent over crossing of two SCROLLERS. This limit only comes into effect if both SCROLLER widgets are overlapping.

#### Prototype



```
void SCROLLER_PreventIntersect(int Enable);
```

#### Parameters

Parameter	Description
Enable	1 for enabling, 0 for disabling.

#### Example

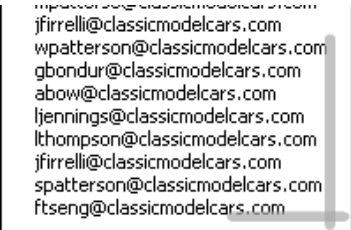
The example below demonstrates how the SCROLLERS are automatically prevented from crossing over each other.

Disabled	Enabled (default)
	

### 7.2.27.8.1.34 SCROLLER\_SetAlign()

#### Description

Sets the given alignment of the SCROLLER.

#### Prototype

```
void SCROLLER_SetAlign(SCROLLER_Handle hObj,  
                       unsigned int   AlignIndex,  
                       U8             Align);
```

#### Parameters

Parameter	Description
<a href="#">hObj</a>	SCROLLER handle.
<a href="#">AlignIndex</a>	See <i>SCROLLER alignment indexes</i> on page 2288 for a full list of permitted values.
<a href="#">Align</a>	New alignment.

### 7.2.27.8.1.35 SCROLLER\_SetAlignOffset()

#### Description

Sets the alignment offset to the SCROLLER rectangle in pixels.

#### Prototype

```
void SCROLLER_SetAlignOffset(SCROLLER_Handle hObj,  
                             I16             Offset);
```

#### Parameters

Parameter	Description
<code>hObj</code>	SCROLLER handle.
<code>Offset</code>	Alignment offset in pixels

### 7.2.27.8.1.36 SCROLLER\_SetAnimEase()

#### Description

Sets the animation ease for a given animation of the SCROLLER. More detailed information about animation ease can be read in the chapter "Animations" under *Position calculation* on page 754.

#### Prototype

```
void SCROLLER_SetAnimEase(SCROLLER_Handle hObj,  
                          unsigned int    AnimIndex,  
                          GUI_ANIM_GETPOS_FUNC pfEase);
```

#### Parameters

Parameter	Description
<a href="#">hObj</a>	Handle to a SCROLLER widget.
<a href="#">AnimIndex</a>	See <i>SCROLLER animation indexes</i> on page 2289.
<a href="#">pfEase</a>	Pointer to position calculation function.

### 7.2.27.8.1.37 SCROLLER\_SetBkColor()

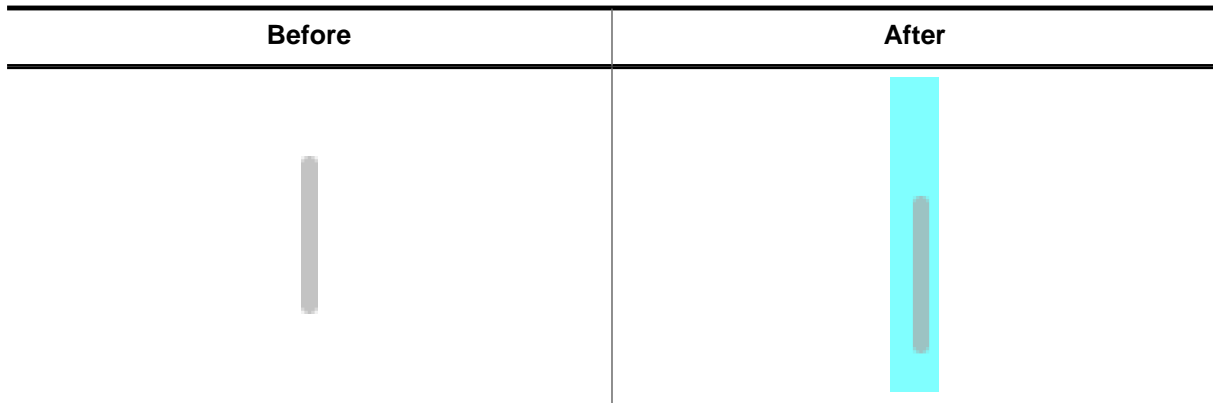

#### Description

Sets the background color of the SCROLLER widget.

#### Prototype



```
void SCROLLER_SetBkColor(SCROLLER_Handle hObj,
                          unsigned int    ColorIndex,
                          GUI_COLOR      BkColor);
```

#### Parameters

Parameter	Description
<code>hObj</code>	Handle to a SCROLLER widget.
<code>ColorIndex</code>	See <i>SCROLLER color indexes</i> on page 2290 for a full list of permitted values.
<code>BkColor</code>	New background color.



### 7.2.27.8.1.38 SCROLLER\_SetColor()

Before	After
	

#### Description

Sets the given color to the SCROLLER widget.

#### Prototype

```
void SCROLLER_SetColor(SCROLLER_Handle hObj,
                       unsigned int    ColorIndex,
                       GUI_COLOR       Color);
```

#### Parameters

Parameter	Description
<code>hObj</code>	SCROLLER handle.
<code>ColorIndex</code>	See <i>SCROLLER color indexes</i> on page 2290 for a full list of permitted values.
<code>Color</code>	New color.

### 7.2.27.8.1.39 SCROLLER\_SetContentRect()

#### Description

Allows to set a custom rectangle that will be used to determine the size of the SCROLLER. Normally, the parent's content rectangle is used for determining the size and position of the SCROLLER. But in some situations the horizontal and vertical SCROLLER may need a different rectangle for this step, so with this function it can be overridden.

#### Prototype

```
void SCROLLER_SetContentRect(      SCROLLER_Handle  hObj,  
                                 const GUI_RECT    * pRect);
```

#### Parameters

Parameter	Description
<code>hObj</code>	Handle to a SCROLLER widget.
<code>pRect</code>	<b>in</b> Override rectangle to be used (will be copied).

#### 7.2.27.8.1.40 SCROLLER\_SetDefaultAlign()

##### Description

Set the given default alignment for newly created SCROLLER widgets.

##### Prototype

```
void SCROLLER_SetDefaultAlign(unsigned int AlignIndex,  
                               U8          Align);
```

##### Parameters

Parameter	Description
<a href="#">AlignIndex</a>	See <i>SCROLLER alignment indexes</i> on page 2288 for a full list of permitted values.
<a href="#">Align</a>	New alignment.

#### 7.2.27.8.1.41 SCROLLER\_SetDefaultAlignOffset()

##### Description

Set the default alignment offset for newly created SCROLLER widgets.

##### Prototype

```
void SCROLLER_SetDefaultAlignOffset(I16 Offset);
```

##### Parameters

Parameter	Description
<a href="#">Offset</a>	New alignment offset.

### 7.2.27.8.1.42 SCROLLER\_SetDefaultAnimEase()

#### Description

Sets the default animation ease for a given animation for SCROLLER widgets.

#### Prototype

```
void SCROLLER_SetDefaultAnimEase(unsigned int AnimIndex,  
GUI_ANIM_GETPOS_FUNC pfEase);
```

#### Parameters

Parameter	Description
<a href="#">AnimIndex</a>	See <i>SCROLLER animation indexes</i> on page 2289.
<a href="#">pfEase</a>	<b>in</b> Pointer to position calculation function.

### 7.2.27.8.1.43 SCROLLER\_SetDefaultBkColor()

#### Description

Sets the default background color of the SCROLLER widget.

#### Prototype

```
void SCROLLER_SetDefaultBkColor(unsigned int ColorIndex,  
                                GUI_COLOR   BkColor);
```

#### Parameters

Parameter	Description
<a href="#">ColorIndex</a>	See <i>SCROLLER color indexes</i> on page 2290 for a full list of permitted values.
<a href="#">BkColor</a>	New default background color.

#### 7.2.27.8.1.44 SCROLLER\_SetDefaultColor()

##### Description

Sets the given default color for newly created SCROLLER widgets.

##### Prototype

```
void SCROLLER_SetDefaultColor(unsigned int ColorIndex,  
                               GUI_COLOR   Color);
```

##### Parameters

Parameter	Description
<a href="#">ColorIndex</a>	See <i>SCROLLER color indexes</i> on page 2290 for a full list of permitted values.
<a href="#">Color</a>	New color.

### 7.2.27.8.1.45 SCROLLER\_SetDefaultPeriod()

#### Description

Sets the given default period for newly created SCROLLER widgets.

#### Prototype

```
void SCROLLER_SetDefaultPeriod(unsigned int PeriodIndex,  
                               int          Period);
```

#### Parameters

Parameter	Description
<a href="#">PeriodIndex</a>	See <i>SCROLLER period indexes</i> on page 2292 for a full list of permitted values.
<a href="#">Period</a>	New period. Must be $\geq 0$ .



### 7.2.27.8.1.46 SCROLLER\_SetDefaultRadius()

#### Description

Sets the default radius for newly created SCROLLER widgets.

#### Prototype

```
void SCROLLER_SetDefaultRadius(I16 Radius);
```

#### Parameters

Parameter	Description
Radius	New radius to be used for the SCROLLER rectangle. Must be $\geq 0$ .

### 7.2.27.8.1.47 SCROLLER\_SetDefaultThumbSizeMin()

#### Description

Sets the default minimum thumb size for newly created SCROLLER widgets.

#### Prototype

```
void SCROLLER_SetDefaultThumbSizeMin(I16 ThumbSize);
```

#### Parameters

Parameter	Description
<a href="#">ThumbSize</a>	Minimum thumb size used for SCROLLER widgets. Must be $\geq 1$ .

### 7.2.27.8.1.48 SCROLLER\_SetDefaultSize()

#### Description

Sets the default width/height of the SCROLLER rectangle. This depends on whether the widget is vertical or horizontal.

#### Prototype

```
void SCROLLER_SetDefaultSize(I16 Size);
```

#### Parameters

Parameter	Description
<code>Size</code>	Default width/height used for SCROLLER widgets. Must be $\geq 1$ .

### 7.2.27.8.1.49 SCROLLER\_SetDefaultSpacing()

#### Description

Sets the default spacing used for newly created SCROLLER widgets.

The spacing and thumb size are added to determine the overall height (if the SCROLLER is horizontal) or the overall width (if the SCROLLER is vertical) and therefore the touch area of the widget.

#### Prototype

```
void SCROLLER_SetDefaultSpacing(I16 Spacing);
```

#### Parameters

Parameter	Description
<a href="#">Spacing</a>	New spacing used for SCROLLER widgets. Must be $\geq 0$ .

### 7.2.27.8.1.50 SCROLLER\_SetInterfaceAPI()

#### Description

Sets the function pointers for the interface between the parent widget and the SCROLLER.

**Note:** This function is only necessary for attaching SCROLLER widgets to custom widgets or windows.

#### Prototype

```
void SCROLLER_SetInterfaceAPI(          SCROLLER_Handle          hObj,  
                                     const SCROLLER_INTERFACE_API * pAPI);
```

#### Parameters

Parameter	Description
<code>hObj</code>	Handle to a SCROLLER widget.
<code>pAPI</code>	<b>in</b> Pointer to a SCROLLER_INTERFACE_API structure. The structure pointed to has to stay persistent in memory!

### 7.2.27.8.1.51 SCROLLER\_SetOwnerDraw()

#### Description

Sets an application defined owner draw function for the widget which is responsible for drawing the SCROLLER bar.

#### Prototype

```
void SCROLLER_SetOwnerDraw(SCROLLER_Handle hObj,  
                           WIDGET_DRAW_ITEM_FUNC * pfOwnerDraw);
```

#### Parameters

Parameter	Description
<code>hObj</code>	Handle to a SCROLLER widget.
<code>pfOwnerDraw</code>	Pointer to owner draw function.

#### Additional information

This function sets a pointer to an application defined function which will be called by the widget when a cell has to be drawn or when the x or y size of a item is needed. It gives you the possibility to draw anything as data item, not just plain text. `pfDrawItem` is a pointer to an application-defined function of type `WIDGET_DRAW_ITEM_FUNC` which is explained at the beginning of the chapter. Also, please refer to `SCROLLER_OwnerDraw()`.

### 7.2.27.8.1.52 SCROLLER\_SetPeriod()

#### Description

Sets the given color to the SCROLLER widget.



#### Prototype

```
void SCROLLER_SetPeriod(SCROLLER_Handle hObj,  
                        unsigned int   PeriodIndex,  
                        int            Period);
```

#### Parameters

Parameter	Description
<code>hObj</code>	SCROLLER handle.
<code>PeriodIndex</code>	See <i>SCROLLER period indexes</i> on page 2292 for a full list of permitted values.
<code>Period</code>	New period in ms, must be $\geq 0$ . A period of 0 will prevent the use of the given animation or timer.

### 7.2.27.8.1.53 SCROLLER\_SetRadius()

Before	After
	

#### Description

Sets the radius of the SCROLLER widget.

#### Prototype

```
void SCROLLER_SetRadius(SCROLLER_Handle hObj,
                        I16                Radius);
```

#### Parameters

Parameter	Description
<a href="#">hObj</a>	SCROLLER handle.
<a href="#">Radius</a>	New radius. Must be $\geq 0$ .

#### Additional information

If the radius is too large that no rounded rectangle with the given rectangle height/width can be drawn, the rectangle is drawn without rounded corners instead.



### 7.2.27.8.1.54 SCROLLER\_SetScrollState()

#### Description

Sets the scroll state of the SCROLLER. Under normal circumstances, this routine does not have to be called as the scroll state should be set automatically.

#### Parameters

Parameter	Description
<code>hObj</code>	Handle to a SCROLLER widget.
<code>pState</code>	<code>in</code> New scroll state.

### 7.2.27.8.1.55 SCROLLER\_SetSize()

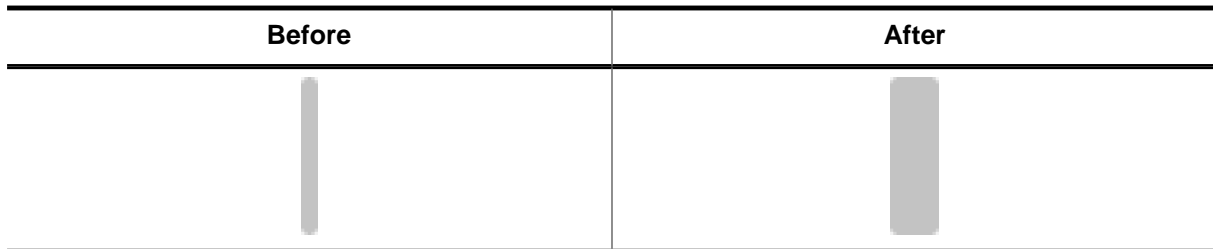

#### Description

Sets the thickness of the SCROLLER thumb rectangle.

**Vertical SCROLLERS:** Width of the thumb rectangle.

**Horizontal SCROLLERS:** Height of the thumb rectangle.

#### Prototype

```
void SCROLLER_SetSize(SCROLLER_Handle hObj,
                      I16              Size);
```

#### Parameters

Parameter	Description
hObj	SCROLLER handle.
Size	New size. Must be $\geq 0$ .

#### Additional information

A new widget size will be set automatically. The widget size is calculated as shown below:

- **Vertical SCROLLERS:** Widget xSize = size + spacing
- **Horizontal SCROLLERS:** Widget ySize = size + spacing

### 7.2.27.8.1.56 SCROLLER\_SetSpacing()

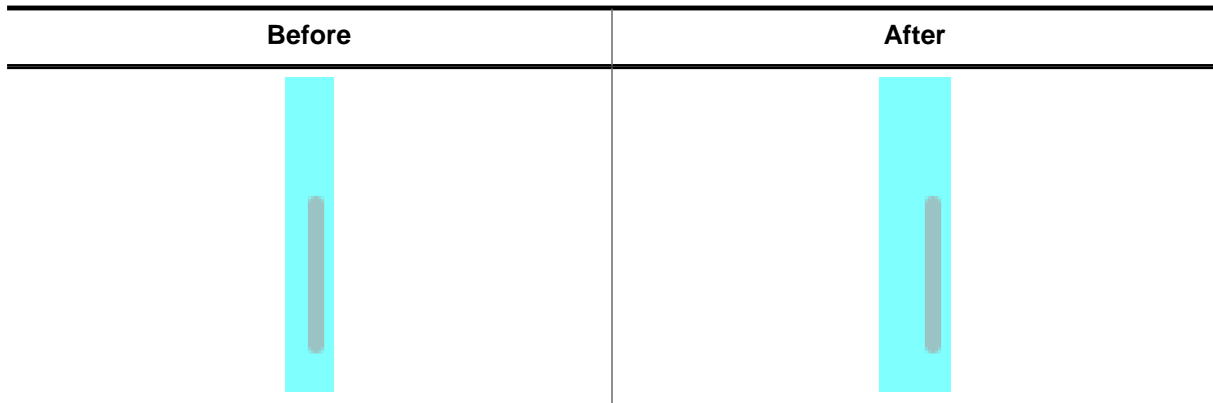

#### Description

Sets the spacing for the SCROLLER widget. The spacing is the empty part of the SCROLLER widget area that is not part of the thumb rectangle.

#### Prototype

```
void SCROLLER_SetSpacing(SCROLLER_Handle hObj,
                          I16             Spacing);
```

#### Parameters

Parameter	Description
<code>hObj</code>	Handle to a SCROLLER widget.
<code>Spacing</code>	New spacing for SCROLLER widget. Must be $\geq 0$ .

#### Additional information

A new widget size will be set automatically. The widget size is calculated as shown below:

- **Vertical SCROLLERS:** Widget `xSize` = size + spacing
- **Horizontal SCROLLERS:** Widget `ySize` = size + spacing

### 7.2.27.8.1.57 SCROLLER\_SetState()

#### Description

Manually sets the state of the SCROLLER to active or inactive.

When setting the state to active, the inactive timer will be started automatically. The timer will not be started if the parameter `NoTimer` is set to 1.

#### Prototype

```
void SCROLLER_SetState(SCROLLER_Handle hObj,
                       U8               Active,
                       U8               NoTimer);
```

#### Parameters

Parameter	Description
<code>hObj</code>	SCROLLER handle.
<code>Active</code>	1 for active, 0 for inactive.
<code>NoTimer</code>	If 1 and <code>Active</code> = 1, the inactive timer will not be started. The SCROLLER would then stay in the active state until normal interaction will start the inactive timer again (e.g. moving the SCROLLER by touch and releasing touch).

#### Additional information

This routine's main purpose is to be used when SCROLLERS are attached to custom widgets. The routine can be used to manually set the appearance of the SCROLLER to active, when e.g. the parent's scroll state was changed by key inputs, or some other input that is not normal touch input.

### 7.2.27.8.1.58 SCROLLER\_SetThumbSizeMin()

#### Description

Sets the minimum thumb size for the SCROLLER widget. Thumb size refers to the SCROLLER rectangle length if the widget is horizontal and the rectangle height if the widget is vertical.

#### Prototype

```
void SCROLLER_SetThumbSizeMin(SCROLLER_Handle hObj,  
                               I16 ThumbSize);
```

#### Parameters

Parameter	Description
<code>hObj</code>	SCROLLER handle.
<code>ThumbSize</code>	New minimum thumb size of the SCROLLER widget. Must be $\geq 1$ .

### 7.2.27.8.1.59 SCROLLER\_SetUserData()

#### Description

Prototype explained at the beginning of the chapter as `<WIDGET>_SetUserData()` on page 1166.

## 7.2.27.8.2 Data structures

### 7.2.27.8.2.1 SCROLLER\_INTERFACE\_API

#### Description

Interface API between the SCROLLER and its parent widget.

This structure is only needed when attaching SCROLLERS to custom widgets or windows.

See also the function `SCROLLER_SetInterfaceAPI()`.

#### Type definition

```
typedef struct {
    void (* pfUpdateScrollPos)(WM_HWIN hParent, SCROLLER_Handle hScroller);
    void (* pfScrollerAdded) (WM_HWIN hParent, SCROLLER_Handle hScroller);
    void (* pfValueChanged) (WM_HWIN hParent, SCROLLER_Handle hScroller, WM_SCROLL_STATE * pNewState);
    void (* pfGetContentRect) (WM_HWIN hParent, GUI_RECT * pRect);
} SCROLLER_INTERFACE_API;
```

#### Structure members

Member	Description
<code>pfUpdateScrollPos</code>	Routine for setting the scroll state of the parent widget to the SCROLLER.
<code>pfScrollerAdded</code>	Routine that is called when the parent receives the <code>WM_NOTIFY_PARENT</code> message with a <code>WM_NOTIFICATION_SCROLLER_ADDED</code> notification.
<code>pfValueChanged</code>	Routine that is called when the parent receives the <code>WM_NOTIFY_PARENT</code> message with a <code>WM_NOTIFICATION_VALUE_CHANGED</code> notification sent by SCROLLER widgets. This routine sets the new scroll state of the SCROLLER to the parent widget.
<code>pfGetContentRect</code>	Routine for retrieving the content rectangle of the parent, called when parent receives a <code>WM_GET_CONTENT_RECT</code> message.

### 7.2.27.8.3 Defines

#### 7.2.27.8.3.1 SCROLLER alignment indexes

##### Description

Alignment indexes for SCROLLER widgets.

##### Definition

```
#define SCROLLER_AI_WIDGETPOS    0
#define SCROLLER_AI_THUMB       1
```

##### Symbols

Definition	Description
<a href="#">SCROLLER_AI_WIDGETPOS</a>	The alignment of the SCROLLER widget within its parent widget (left or right, bottom or top).
<a href="#">SCROLLER_AI_THUMB</a>	The alignment of the thumb rectangle within the SCROLLER widget. Allowed values for vertical SCROLLERS: GUI_ALIGN_LEFT, GUI_ALIGN_HCENTER, GUI_ALIGN_RIGHT Allowed values for horizontal SCROLLERS: GUI_ALIGN_TOP, GUI_ALIGN_VCENTER, GUI_ALIGN_BOTTOM



### 7.2.27.8.3.2 SCROLLER animation indexes

#### Description

Animation indexes used for `SCROLLER_SetAnimEase()`.

#### Definition

```
#define SCROLLER_ANIM_FADE      0
#define SCROLLER_ANIM_SCROLL   1
```

#### Symbols

Definition	Description
<a href="#">SCROLLER_ANIM_FADE</a>	Animation for fading between the active and inactive state.
<a href="#">SCROLLER_ANIM_SCROLL</a>	Animation for animating the scroll state when the SCROLLER was clicked outside of the thumb rectangle.

### 7.2.27.8.3.3 SCROLLER color indexes

#### Description

Color indexes for SCROLLER widgets.

#### Definition

```
#define SCROLLER_CI_ACTIVE      0
#define SCROLLER_CI_INACTIVE   1
```

#### Symbols

Definition	Description
<a href="#">SCROLLER_CI_ACTIVE</a>	Color for active state (when the scroller is moving or receives touch input).
<a href="#">SCROLLER_CI_INACTIVE</a>	Color for inactive state.

### 7.2.27.8.3.4 SCROLLER create flags

#### Description

Create flags for SCROLLER widgets.

#### Definition

```
#define SCROLLER_CF_FADING      (1 << 0)
#define SCROLLER_CF_TOUCH      (1 << 1)
#define SCROLLER_CF_VERTICAL    (1 << 3)
#define SCROLLER_CF_HORIZONTAL (0 << 3)
```

#### Symbols

Definition	Description
<a href="#">SCROLLER_CF_FADING</a>	Enables automatic fading between the active and inactive state of the SCROLLER.
<a href="#">SCROLLER_CF_TOUCH</a>	Enables touch input for the SCROLLER.
<a href="#">SCROLLER_CF_VERTICAL</a>	Creates a vertical SCROLLER.
<a href="#">SCROLLER_CF_HORIZONTAL</a>	Creates a horizontal SCROLLER.

### 7.2.27.8.3.5 SCROLLER period indexes

#### Description

Period indexes for SCROLLER widgets.

#### Definition

```
#define SCROLLER_PI_FADE_IN      0
#define SCROLLER_PI_FADE_OUT    1
#define SCROLLER_PI_INACTIVE    2
#define SCROLLER_PI_ANIM_SCROLL 3
```

#### Symbols

Definition	Description
<a href="#">SCROLLER_PI_FADE_IN</a>	The length in ms for fading in, from inactive to active color.
<a href="#">SCROLLER_PI_FADE_OUT</a>	The length in ms for fading out, from active color to inactive color.
<a href="#">SCROLLER_PI_INACTIVE</a>	Period it takes from releasing the widget until the fade operation is started.
<a href="#">SCROLLER_PI_ANIM_SCROLL</a>	Period for animating the changing of the scroll state when the SCROLLER was moved by touch.

## 7.2.28 SLIDER: Slider widget

SLIDER widgets are commonly used for modifying values through the use of a slider bar. The widget consists of a slider bar and tick marks beside the bar. These tick marks can be used to snap the slider bar while dragging it. For details about how to use the tick marks for snapping refer to the function `SLIDER_SetRange()`.

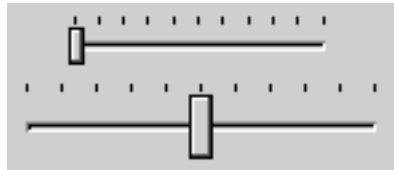

### Note

All SLIDER-related routines are located in the file(s) `SLIDER*.c`, `SLIDER.h`. All identifiers are prefixed `SLIDER`.

### Skinning...



...is available for this widget. The screenshot above shows the widget using the default skin. Details can be found in the chapter *Skinning* on page 2800.

### Note

This widget uses skinning. To change the look it is recommended to use the function `<WIDGET>_SetSkinFlexProps()`. Other functions to change the look might work only with the classic skin.

### 7.2.28.1 Configuration options

Type	Macro	Default	Description
N	<code>SLIDER_BKCOLOR0_DEFAULT</code>	<code>0xc0c0c0</code>	Background color.
N	<code>SLIDER_COLOR0_DEFAULT</code>	<code>0xc0c0c0</code>	Slider (thumb) color.
N	<code>SLIDER_FOCUSCOLOR_DEFAULT</code>	<code>GUI_BLACK</code>	Default color for rendering the focus rectangle.

### 7.2.28.2 Predefined IDs

The following symbols define IDs which may be used to make SLIDER widgets distinguishable from creation.

```
#define GUI_ID_SLIDER0    0x130
#define GUI_ID_SLIDER1    0x131
#define GUI_ID_SLIDER2    0x132
#define GUI_ID_SLIDER3    0x133
#define GUI_ID_SLIDER4    0x134
#define GUI_ID_SLIDER5    0x135
#define GUI_ID_SLIDER6    0x136
#define GUI_ID_SLIDER7    0x137
#define GUI_ID_SLIDER8    0x138
#define GUI_ID_SLIDER9    0x139
```

### 7.2.28.3 Notification codes

The following events are sent from a SLIDER widget to its parent window as part of a WM\_NOTIFY\_PARENT message:

Message	Description
WM_NOTIFICATION_CLICKED	SLIDER widget has been clicked.
WM_NOTIFICATION_RELEASED	SLIDER widget has been released.
WM_NOTIFICATION_VALUE_CHANGED	Value of the SLIDER widget has changed by moving the thumb.

#### 7.2.28.3.1 Keyboard reaction

The widget reacts to the following keys if it has the input focus:

Key	Description
GUI_KEY_RIGHT	Increments the current value of the SLIDER widget by one item.
GUI_KEY_LEFT	Decrements the current value of the SLIDER widget by one item.

### 7.2.28.4 SLIDER API

The table below lists the available emWin SLIDER-related routines in alphabetical order. Detailed descriptions of the routines follow.

#### Functions

Routine	Description
<a href="#">SLIDER_Create()</a>	Creates a SLIDER widget. (Obsolete)
<a href="#">SLIDER_CreateEx()</a>	Creates a SLIDER widget.
<a href="#">SLIDER_CreateIndirect()</a>	Creates a SLIDER widget from resource table entry.
<a href="#">SLIDER_CreateUser()</a>	Creates a SLIDER widget using extra bytes as user data.
<a href="#">SLIDER_Dec()</a>	Decrements the value of the SLIDER widget.
<a href="#">SLIDER_EnableFocusRect()</a>	Enables or disables the focus rectangle.
<a href="#">SLIDER_GetBkColor()</a>	Returns the background color of the SLIDER widget.
<a href="#">SLIDER_GetFocusColor()</a>	Return the color focus rectangle of the SLIDER widget.
<a href="#">SLIDER_GetRange()</a>	The function returns the range of the given SLIDER widget.
<a href="#">SLIDER_GetUserData()</a>	Returns the data set with <a href="#">SLIDER_SetUserData()</a> .
<a href="#">SLIDER_GetValue()</a>	Returns the current value of the SLIDER widget.
<a href="#">SLIDER_Inc()</a>	Increments the value of the SLIDER widget.
<a href="#">SLIDER_SetBkColor()</a>	Sets the background color of the SLIDER widget.
<a href="#">SLIDER_SetDefaultFocusColor()</a>	Sets the default focus rectangle color for new SLIDER widgets.
<a href="#">SLIDER_SetFocusColor()</a>	Sets the color used to render the focus rectangle of the SLIDER widget.
<a href="#">SLIDER_SetInvertDir()</a>	This function inverts the slider.

<b>Routine</b>	<b>Description</b>
<code>SLIDER_SetNumTicks()</code>	Sets the number of tick marks of the SLIDER widget.
<code>SLIDER_SetRange()</code>	Sets the range of the SLIDER widget.
<code>SLIDER_SetUserData()</code>	Sets the extra data of a SLIDER widget.
<code>SLIDER_SetValue()</code>	Sets the current value of the SLIDER widget.
<code>SLIDER_SetWidth()</code>	Sets the width of the SLIDER widget.

## Defines

<b>Group of defines</b>	<b>Description</b>
<code>SLIDER create flags</code>	Create flags for SLIDER widget.

## 7.2.28.4.1 Functions

### 7.2.28.4.1.1 SLIDER\_Create()

#### Note

This function is **deprecated**, `SLIDER_CreateEx()` should be used instead.

#### Description

Creates a SLIDER widget of a specified size at a specified location.

#### Prototype

```
SLIDER_Handle SLIDER_Create(int    x0,
                             int    y0,
                             int    xSize,
                             int    ySize,
                             WM_HWIN hParent,
                             int    Id,
                             int    WinFlags,
                             int    SpecialFlags);
```

#### Parameters

Parameter	Description
<code>x0</code>	Leftmost pixel of the slider (in parent coordinates).
<code>y0</code>	Topmost pixel of the slider (in parent coordinates).
<code>xSize</code>	Horizontal size of the slider (in pixels).
<code>ySize</code>	Vertical size of the slider (in pixels).
<code>hParent</code>	Handle of the parent window.
<code>Id</code>	<code>Id</code> to be returned
<code>WinFlags</code>	Window create flags. Typically <code>WM_CF_SHOW</code> in order to make the widget visible immediately (refer to <i>Window create flags</i> on page 1146 for a list of available parameter values).
<code>SpecialFlags</code>	Special creation flag (see indirect creation flag under <i>SLIDER_CreateIndirect</i> on page 2298).

#### Return value

Handle of the created SLIDER widget; 0 if the function fails.



### 7.2.28.4.1.2 SLIDER\_CreateEx()

#### Description

Creates a SLIDER widget of a specified size at a specified location.

#### Prototype

```
SLIDER_Handle SLIDER_CreateEx(int    x0,
                              int    y0,
                              int    xSize,
                              int    ySize,
                              WM_HWIN hParent,
                              int    WinFlags,
                              int    ExFlags,
                              int    Id);
```

#### Parameters

Parameter	Description
<code>x0</code>	Leftmost pixel of the widget (in parent coordinates).
<code>y0</code>	Topmost pixel of the widget (in parent coordinates).
<code>xSize</code>	Horizontal size of the widget (in pixels).
<code>ySize</code>	Vertical size of the widget (in pixels).
<code>hParent</code>	Handle of the parent window. If 0, the new SLIDER widget will be a child of the desktop (top-level window).
<code>WinFlags</code>	Window create flags. Typically <code>WM_CF_SHOW</code> in order to make the widget visible immediately (refer to <i>Window create flags</i> on page 1146 for a list of available parameter values).
<code>ExFlags</code>	See <i>SLIDER create flags</i> on page 2317.
<code>Id</code>	Window ID of the widget.

#### Return value

Handle of the created SLIDER widget; 0 if the function fails.

### 7.2.28.4.1.3 SLIDER\_CreateIndirect()

#### Description

The prototype of this function is explained at the beginning of this chapter. Details can be found in the description of the function `<WIDGET>_CreateIndirect()` on page 1161. The element `Para` of the according `GUI_WIDGET_CREATE_INFO` structure is not used. The element `Flags` is used according to the parameter `ExFlags` of the function `SLIDER_CreateEx()`.

#### 7.2.28.4.1.4 SLIDER\_CreateUser()

##### Description

Prototype explained at the beginning of the chapter as `<WIDGET>_CreateUser()` on page 1162. For a detailed description of the parameters the function `SLIDER_CreateEx()` can be referred to.

### 7.2.28.4.1.5 SLIDER\_Dec()

#### Description

Decrements the current value of the SLIDER widget by one item.

#### Prototype

```
void SLIDER_Dec(SLIDER_Handle hObj);
```

#### Parameters

Parameter	Description
<a href="#">hObj</a>	Handle of SLIDER widget.

### 7.2.28.4.1.6 SLIDER\_EnableFocusRect()

#### Description

This function enables or disables the rectangle shown when a slider has the focus.

#### Prototype

```
void SLIDER_EnableFocusRect (SLIDER_Handle hObj,  
                             int           OnOff);
```

#### Parameters

Parameter	Description
<code>hObj</code>	Handle of SLIDER widget.
<code>OnOff</code>	Enables (1) or disables (0) the focus rect.

### 7.2.28.4.1.7 SLIDER\_GetBkColor()

#### Description

Returns the background color of the SLIDER widget.

#### Prototype

```
GUI_COLOR SLIDER_GetBkColor(SLIDER_Handle hObj);
```

#### Parameters

Parameter	Description
<a href="#">hObj</a>	Handle of SLIDER widget.

#### Return value

The background color of the SLIDER widget.

### 7.2.28.4.1.8 SLIDER\_GetFocusColor()

#### Description

Return the color focus rectangle of the SLIDER widget.

#### Prototype

```
GUI_COLOR SLIDER_GetFocusColor(SLIDER_Handle hObj);
```

#### Parameters

Parameter	Description
<a href="#">hObj</a>	Handle of SLIDER widget.

#### Return value

The color of the focus rectangle of the SLIDER widget.

### 7.2.28.4.1.9 SLIDER\_GetRange()

#### Description

The function returns the range of the given SLIDER widget.

#### Prototype

```
void SLIDER_GetRange(SLIDER_Handle hObj,  
                    int * pMin,  
                    int * pMax);
```

#### Parameters

Parameter	Description
<a href="#">hObj</a>	Handle of SLIDER widget.
<a href="#">pMin</a>	Pointer to an int to be used to return the min-value. Should not be NULL.
<a href="#">pMax</a>	Pointer to an int to be used to return the max-value. Should not be NULL.



#### 7.2.28.4.1.10 SLIDER\_GetUserData()

##### Description

Prototype explained at the beginning of the chapter as `<WIDGET>_GetUserData()` on page 1165.

#### 7.2.28.4.1.11 SLIDER\_GetValue()

##### Description

Returns the current value of the SLIDER widget.

##### Prototype

```
int SLIDER_GetValue(SLIDER_Handle hObj);
```

##### Parameters

Parameter	Description
<a href="#">hObj</a>	Handle of SLIDER widget.

##### Return value

The current value of the SLIDER widget.

### 7.2.28.4.1.12 SLIDER\_Inc()

#### Description

Increments the current value of the SLIDER widget by one item.

#### Prototype

```
void SLIDER_Inc(SLIDER_Handle hObj);
```

#### Parameters

Parameter	Description
<code>hObj</code>	Handle of SLIDER widget.

### 7.2.28.4.1.13 SLIDER\_SetBkColor()

#### Description

Sets the background color of the SLIDER widget.

#### Prototype

```
void SLIDER_SetBkColor(SLIDER_Handle hObj,
                      GUI_COLOR      Color);
```

#### Parameters

Parameter	Description
<code>hObj</code>	Handle of SLIDER widget.
<code>Color</code>	<code>Color</code> to be used for the background. (range 0x000000 and 0xFFFFFFFF or a valid color define) <code>GUI_INVALID_COLOR</code> to make background transparent.

#### Additional information

The background of this widget can either be filled with any available color or transparent. If a valid RGB color is specified, the background is filled with the color, otherwise the background (typically the content of the parent window) is visible. If the background is transparent, the widget is treated as transparent window, otherwise as non-transparent window. Note that using a background color allows more efficient (faster) rendering.

This widget is per default a transparent window. The appearance of a transparent windows background depends on the appearance of the parent window. When a transparent window needs to be redrawn first the background will be drawn by sending a `WM_PAINT` message to the parent window.

If using this function with a valid color the status of the window will be changed from transparent to non transparent and if the window needs to be redrawn the background will be filled with the given color.

If `GUI_INVALID_COLOR` is passed to the function the status will be changed from non transparent to transparent.

#### 7.2.28.4.1.14 SLIDER\_SetDefaultFocusColor()

##### Description

Sets the default focus rectangle color for new SLIDER widgets.

##### Prototype

```
GUI_COLOR SLIDER_SetDefaultFocusColor(GUI_COLOR Color);
```

##### Parameters

Parameter	Description
Color	Default color to be used for new slider bars.

##### Return value

Previous default focus rectangle color.

##### Additional information

For more information, refer to *SLIDER\_SetFocusColor* on page 2310.

### 7.2.28.4.1.15 SLIDER\_SetFocusColor()



#### Description

Sets the color used to render the focus rectangle of the SLIDER widget.

#### Prototype

```
GUI_COLOR SLIDER_SetFocusColor(SLIDER_Handle hObj,
                               GUI_COLOR    Color);
```

#### Parameters

Parameter	Description
<code>hObj</code>	Handle of SLIDER widget.
<code>Color</code>	<code>Color</code> to be used for the focus rectangle.

#### Return value

Previous color of the focus rectangle.

#### Additional information

The focus rectangle is only visible if the widget has the input focus.

### 7.2.28.4.1.16 SLIDER\_SetInvertDir()

#### Description

This function inverts the slider.

#### Prototype

```
void SLIDER_SetInvertDir(SLIDER_Handle hObj,  
                        int OnOff);
```

#### Parameters

Parameter	Description
<code>hObj</code>	Handle of SLIDER widget.
<code>OnOff</code>	Enables (1) or disables (0) the inversion of the slider widget.

### 7.2.28.4.1.17 SLIDER\_SetNumTicks()



#### Description

Sets the number of tick marks of the SLIDER widget.

#### Prototype

```
void SLIDER_SetNumTicks(SLIDER_Handle hObj,
                        int NumTicks);
```

#### Parameters

Parameter	Description
hObj	Handle of SLIDER widget.
NumTicks	Number of tick marks drawn.

#### Additional information

After creating a SLIDER widget the default number of tick marks is 10. The tick marks have no effect to snap the slider bar while dragging it.



### 7.2.28.4.1.18 SLIDER\_SetRange()

#### Description

Sets the range of the SLIDER widget.

#### Prototype

```
void SLIDER_SetRange(SLIDER_Handle hObj,
                    int           Min,
                    int           Max);
```

#### Parameters

Parameter	Description
<code>hObj</code>	Handle of SLIDER widget.
<code>Min</code>	Minimum value.
<code>Max</code>	Maximum value.

#### Additional information

After creating a SLIDER widget the default range is set to 0 - 100.

#### Examples

If a value should be modified in the range of 0 - 2499 set the range as follows:

```
SLIDER_SetRange(hSlider, 0, 2499);
```

If a value should be modified in the range of 100 - 499 set the range as follows:

```
SLIDER_SetRange(hSlider, 100, 499);
```

If a value should be modified in the range of 0 to 5000 and the slider bar should change the value in steps of 250 set the range and the tick marks as follows. The result returned by `SLIDER_GetValue()` should be multiplied with 250:

```
SLIDER_SetRange(hSlider, 0, 20);
SLIDER_SetNumTicks(hSlider, 21);
```

#### 7.2.28.4.1.19 SLIDER\_SetUserData()

##### Description

Prototype explained at the beginning of the chapter as `<WIDGET>_SetUserData()` on page 1166.

#### 7.2.28.4.1.20 SLIDER\_SetValue()

##### Description

Sets the current value of the SLIDER widget.

##### Prototype

```
void SLIDER_SetValue(SLIDER_Handle hObj,  
                    int v);
```

##### Parameters

Parameter	Description
<code>hObj</code>	Handle of SLIDER widget.
<code>v</code>	Value to be set.

#### 7.2.28.4.1.21 SLIDER\_SetWidth()



### Description

Sets the width of the SLIDER widget.

### Prototype

```
void SLIDER_SetWidth(SLIDER_Handle hObj,  
                    int Width);
```

### Parameters

Parameter	Description
hObj	Handle of SLIDER widget.
Width	Width to be set.

## 7.2.28.4.2 Defines

### 7.2.28.4.2.1 SLIDER create flags

#### Description

Create flags for SLIDER widgets which define the rotation of a SLIDER.

#### Definition

```
#define SLIDER_CF_HORIZONTAL    (0)
#define SLIDER_CF_VERTICAL    (1 << 3)
```

#### Symbols

Definition	Description
<a href="#">SLIDER_CF_HORIZONTAL</a>	Creates a horizontal slider (default).
<a href="#">SLIDER_CF_VERTICAL</a>	Creates a vertical slider.

## 7.2.28.5 Example

The `Sample` folder contains the following example which shows how the widget can be used:

- `DIALOG_SliderColor.c`

Note that several other examples also make use of this widget and may also be helpful to get familiar with the widget.

### Screenshot of `DIALOG_SliderColor.c`

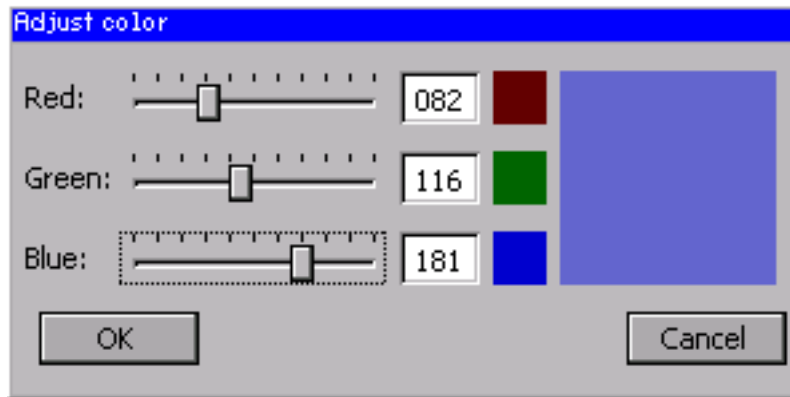

## 7.2.29 SPINBOX: Spinning box widget

SPINBOX widgets are used to manage values which need to be adjustable in a fast but still precise manner. A SPINBOX consists of 2 buttons and an embedded EDIT widget.

### Note

All SPINBOX-related routines are located in the file(s) `SPINBOX*.c` and `SPINBOX.h`. All identifiers are prefixed `SPINBOX`.

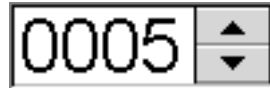

### Skining...

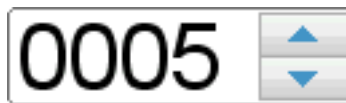

...is available for this widget. The screenshot above shows the widget using the default skin. Details can be found in the chapter *Skining* on page 2800.

### Note

This widget uses skinning. To change the look it is recommended to use the function `<WIDGET>_SetSkinFlexProps()`. Other functions to change the look might work only with the classic skin.

### 7.2.29.1 Configuration options

Type	Macro	Default	Description
N	<code>SPINBOX_DEFAULT_BUTTON_BKCOLOR0</code>	<code>0xAAAAAA</code>	Background color for the button state disabled.
N	<code>SPINBOX_DEFAULT_BUTTON_BKCOLOR1</code>	<code>GUI_WHITE</code>	Background color for the button state pressed.
N	<code>SPINBOX_DEFAULT_BUTTON_BKCOLOR2</code>	<code>GUI_LIGHTGRAY</code>	Background color for the button state unpressed.
N	<code>SPINBOX_DEFAULT_BUTTON_UCOLOR0</code>	<code>GUI_GRAY_C8</code>	Background color for the button state disabled.
N	<code>SPINBOX_DEFAULT_BUTTON_UCOLOR1</code>	<code>GUI_WHITE</code>	Background color for the button state pressed.
N	<code>SPINBOX_DEFAULT_BUTTON_UCOLOR2</code>	<code>GUI_LIGHTGRAY</code>	Background color for the button state unpressed.
N	<code>SPINBOX_DEFAULT_BUTTON_LCOLOR0</code>	<code>0x505050</code>	Background color for the button state disabled.
N	<code>SPINBOX_DEFAULT_BUTTON_LCOLOR1</code>	<code>GUI_GRAY</code>	Background color for the button state pressed.
N	<code>SPINBOX_DEFAULT_BUTTON_LCOLOR2</code>	<code>GUI_LIGHTGRAY</code>	Background color for the button state unpressed.
N	<code>SPINBOX_DEFAULT_BUTTON_OCOLOR0</code>	<code>0x3F3F3F</code>	Background color for the button state disabled.
N	<code>SPINBOX_DEFAULT_BUTTON_OCOLOR1</code>	<code>GUI_BLACK</code>	Background color for the button state pressed.

Type	Macro	Default	Description
N	SPINBOX_DEFAULT_BUTTON_OCOLOR2	GUI_DARKGRAY	Background color for the button state unpressed.
N	SPINBOX_DEFAULT_BKCOLOR0	0xC0C0C0	Background color for the edit state disabled.
N	SPINBOX_DEFAULT_BKCOLOR1	GUI_WHITE	Background color for the edit state enabled.
N	SPINBOX_DEFAULT_TEXTCOLOR0	0x3F3F3F	Background color for the edit state disabled.
N	SPINBOX_DEFAULT_TEXTCOLOR1	GUI_BLACK	Background color for the edit state enabled.
N	SPINBOX_DEFAULT_TRIANGLE_COLOR0	GUI_GRAY_3F	Background color for the button state disabled.
N	SPINBOX_DEFAULT_TRIANGLE_COLOR1	GUI_BLACK	Background color for the button state pressed.
N	SPINBOX_DEFAULT_TRIANGLE_COLOR2	GUI_DARKGRAY	Background color for the button state unpressed.
N	SPINBOX_DEFAULT_MIN	0	Minimum value.
N	SPINBOX_DEFAULT_MAX	100	Maximum value.
N	SPINBOX_DEFAULT_STEP	1	Value will be increased/decreased by this amount when a button is clicked.
N	SPINBOX_DEFAULT_BUTTON_SIZE	0	X-Size of the buttons.
N	SPINBOX_DEFAULT_EDGE	SPINBOX_EDGE_RIGHT	Determines the position of the buttons. See table below.
N	SPINBOX_TIMER_PERIOD_START	400	Once a button is pressed for this amount of time, a timer is created to increase/decrease the value continuously.
N	SPINBOX_TIMER_PERIOD	50	Once the timer is created values are adjusted at intervals of this amount of time.

Possible values to be defined as SPINBOX_DEFAULT_EDGE	
SPINBOX_EDGE_LEFT	Buttons are displayed on the left edge of the widget.
SPINBOX_EDGE_RIGHT	Buttons are displayed on the right edge of the widget.

## 7.2.29.2 Predefined IDs

The following symbols define IDs which may be used to make SPINBOX widgets distinguishable from creation.

```
#define GUI_ID_SPINBOX0    0x280
#define GUI_ID_SPINBOX1    0x281
#define GUI_ID_SPINBOX2    0x282
#define GUI_ID_SPINBOX3    0x283
#define GUI_ID_SPINBOX4    0x284
#define GUI_ID_SPINBOX5    0x285
#define GUI_ID_SPINBOX6    0x286
#define GUI_ID_SPINBOX7    0x287
#define GUI_ID_SPINBOX8    0x288
#define GUI_ID_SPINBOX9    0x289
```



### 7.2.29.3 Notification codes

The following events are sent from the spinbox widget to its parent window as part of a WM\_NOTIFY\_PARENT message:

Message	Description
WM_NOTIFICATION_CLICKED	Button has been clicked.
WM_NOTIFICATION_RELEASED	Button has been released.
WM_NOTIFICATION_MOVED_OUT	Pointer has been moved out of the widget area.
WM_NOTIFICATION_VALUE_CHANGED	The value of the SPINBOX widget has changed.

### 7.2.29.4 Keyboard reaction

The widget is able to receive the input focus. All key events are forwarded to the embedded edit widget. Detailed information can be taken from the EDIT widget section.

### 7.2.29.5 SPINBOX API

The table below lists the available emWin SPINBOX-related routines in alphabetical order. Detailed descriptions of the routines follow.

#### Functions

Routine	Description
<a href="#">SPINBOX_CreateEx()</a>	Creates a SPINBOX widget.
<a href="#">SPINBOX_CreateIndirect()</a>	Creates a SPINBOX widget. (Obsolete)
<a href="#">SPINBOX_CreateUser()</a>	Creates a SPINBOX widget using extra bytes as user data.
<a href="#">SPINBOX_EnableBlink()</a>	Enables/disables blinking of the cursor.
<a href="#">SPINBOX_GetBkColor()</a>	Returns the background color of the SPINBOX widget.
<a href="#">SPINBOX_GetButtonBkColor()</a>	Returns the background color of the buttons.
<a href="#">SPINBOX_GetDefaultButtonSize()</a>	Returns the default x-size of the buttons.
<a href="#">SPINBOX_GetEditHandle()</a>	Returns the handle to the attached EDIT widget.
<a href="#">SPINBOX_GetFont()</a>	Returns the font of the SPINBOX widget.
<a href="#">SPINBOX_GetRange()</a>	Gets the minimum and maximum value set for the SPINBOX.
<a href="#">SPINBOX_GetTextColor()</a>	Returns the text color.
<a href="#">SPINBOX_GetUserData()</a>	Retrieves the data which was previously set with <a href="#">SPINBOX_SetUserData()</a> .
<a href="#">SPINBOX_GetValue()</a>	Returns the value of the SPINBOX widget.
<a href="#">SPINBOX_SetBkColor()</a>	Sets the background color of the SPINBOX widget.
<a href="#">SPINBOX_SetButtonBkColor()</a>	Sets the background color of the buttons.
<a href="#">SPINBOX_SetButtonSize()</a>	Sets the button size of the given SPINBOX widget.
<a href="#">SPINBOX_SetDefaultButtonSize()</a>	Sets the default x-size of the buttons.
<a href="#">SPINBOX_SetEdge()</a>	Sets the edge to display the buttons on.
<a href="#">SPINBOX_SetEditMode()</a>	Sets the spinbox widget to either edit or step mode.
<a href="#">SPINBOX_SetFont()</a>	Sets the font used to display the value.

Routine	Description
<code>SPINBOX_SetRange()</code>	Sets the minimum and maximum value.
<code>SPINBOX_SetStep()</code>	Sets the value to be used for incrementing and decrementing in 'Step' mode.
<code>SPINBOX_SetTextColor()</code>	Sets the color of the displayed value.
<code>SPINBOX_SetTimerPeriod()</code>	This function sets the time it takes before the SPINBOX widget starts increasing or decreasing its value automatically when a button keeps being pressed.
<code>SPINBOX_SetUserData()</code>	Stores user data using the extra bytes which were reserved by <code>SPINBOX_CreateUser()</code> .
<code>SPINBOX_SetValue()</code>	Sets the value of the SPINBOX.

## Defines

Group of defines	Description
<code>SPINBOX color indexes</code>	Color indexes used by SPINBOX widgets.
<code>SPINBOX edge flags</code>	Flags used by <code>SPINBOX_SetEdge()</code> .
<code>SPINBOX edit mode flags</code>	Flags used by <code>SPINBOX_SetEditMode()</code> .
<code>SPINBOX timer indexes</code>	Timer indexes used by <code>SPINBOX_SetTimerPeriod()</code> .

## 7.2.29.5.1 Functions

### 7.2.29.5.1.1 SPINBOX\_CreateEx()

#### Description

Creates a SPINBOX widget.

#### Prototype

```
SPINBOX_Handle SPINBOX_CreateEx(int    x0,
                                int    y0,
                                int    xSize,
                                int    ySize,
                                WM_HWIN hParent,
                                int    WinFlags,
                                int    Id,
                                int    Min,
                                int    Max);
```

#### Parameters

Parameter	Description
<code>x0</code>	Leftmost pixel of the widget (in parent coordinates).
<code>y0</code>	Topmost pixel of the widget (in parent coordinates).
<code>xSize</code>	Horizontal size of the widget (in pixels).
<code>ySize</code>	Vertical size of the widget (in pixels).
<code>hParent</code>	Handle of the parent window. If 0, the widget will be created as a child of the top-level window (desktop).
<code>WinFlags</code>	Window create flags. In order to make the widget visible immediately <code>WM_CF_SHOW</code> should be used. The complete list of available parameters can be found under <i>Window create flags</i> on page 1146.
<code>Id</code>	Window ID to be set for the widget.
<code>Min</code>	Minimum permitted value.
<code>Max</code>	Maximum permitted value.

#### Return value

Handle of the created SPINBOX widget. If an error occurred during creation, 0 is returned.

### 7.2.29.5.1.2 SPINBOX\_CreateIndirect()

#### Description

The prototype of this function is explained at the beginning of this chapter. Details can be found in the description of the function `<WIDGET>_CreateIndirect()` on page 1161. The element `Flags` of the according `GUI_WIDGET_CREATE_INFO` structure is not used. The upper 16 bit of the element `Para` are used according to the parameter `Max` of the function `SPINBOX_CreateEx()`. The lower 16 bit of the element `Para` are used according to the parameter `Min` of the function `SPINBOX_CreateEx()`.

### 7.2.29.5.1.3 SPINBOX\_CreateUser()

#### Description

Prototype explained at the beginning of the chapter as `<WIDGET>_CreateUser()` on page 1162. For a detailed description of the parameters the function `SPINBOX_CreateEx()` can be referred to.

#### 7.2.29.5.1.4 SPINBOX\_EnableBlink()

##### Description

Enables/disables blinking of the cursor.

##### Prototype

```
void SPINBOX_EnableBlink(SPINBOX_Handle hObj,  
                        int             Period,  
                        int             OnOff);
```

##### Parameters

Parameter	Description
<code>hObj</code>	Handle of the SPINBOX widget.
<code>Period</code>	<code>Period</code> in which the cursor is turned off and on.
<code>OnOff</code>	1 enables blinking, 0 disables blinking.

### 7.2.29.5.1.5 SPINBOX\_GetBkColor()

#### Description

Returns the background color of the SPINBOX widget.

#### Prototype

```
GUI_COLOR SPINBOX_GetBkColor(SPINBOX_Handle hObj,  
                             unsigned int   Index);
```

#### Parameters

Parameter	Description
<a href="#">hObj</a>	Handle of the SPINBOX widget.
<a href="#">Index</a>	See <i>SPINBOX color indexes</i> on page 2349 for a full list of permitted values.

#### Return value

Background color of the SPINBOX widget.

### 7.2.29.5.1.6 SPINBOX\_GetButtonBkColor()

#### Description

Returns the background color of the buttons.

#### Prototype

```
GUI_COLOR SPINBOX_GetButtonBkColor(SPINBOX_Handle hObj,  
                                   unsigned int   Index);
```

#### Parameters

Parameter	Description
<a href="#">hObj</a>	Handle of the SPINBOX widget.
<a href="#">Index</a>	See <i>SPINBOX color indexes</i> on page 2349 for a full list of permitted values.

#### Return value

Background color of the buttons.



### 7.2.29.5.1.7 SPINBOX\_GetDefaultButtonSize()

#### Description

Returns the default x-size of the buttons.

#### Prototype

```
U16 SPINBOX_GetDefaultButtonSize(void);
```

#### Return value

Default x-size of the buttons.

### 7.2.29.5.1.8 SPINBOX\_GetEditHandle()

#### Description

Returns the handle to the attached EDIT widget.

#### Prototype

```
EDIT_Handle SPINBOX_GetEditHandle(SPINBOX_Handle hObj);
```

#### Parameters

Parameter	Description
<a href="#">hObj</a>	Handle of the SPINBOX widget.

#### Return value

Handle of the attached EDIT widget.

### 7.2.29.5.1.9 SPINBOX\_GetFont()

#### Description

Returns the font of the SPINBOX widget.

#### Prototype

```
GUI_FONT *SPINBOX_GetFont(SPINBOX_Handle hObj);
```

#### Parameters

Parameter	Description
<a href="#">hObj</a>	Handle of the SPINBOX widget.

#### Return value

A pointer to the font of the SPINBOX widget.

### 7.2.29.5.1.10 SPINBOX\_GetRange()

#### Description

Gets the minimum and maximum value set for the SPINBOX.

#### Prototype

```
void SPINBOX_GetRange(SPINBOX_Handle hObj,  
                     I32             * pMin,  
                     I32             * pMax);
```

#### Parameters

Parameter	Description
<a href="#">hObj</a>	Handle to the SPINBOX widget.
<a href="#">pMin</a>	Minimum value.
<a href="#">pMax</a>	Maximum value.

### 7.2.29.5.1.11 SPINBOX\_GetTextColor()

#### Description

Returns the color of the displayed value.

#### Prototype

```
GUI_COLOR SPINBOX_GetTextColor(SPINBOX_Handle hObj,  
                               unsigned int   Index);
```

#### Parameters

Parameter	Description
<a href="#">hObj</a>	Handle of the SPINBOX widget.
<a href="#">Index</a>	See <i>SPINBOX color indexes</i> on page 2349 for a full list of permitted values.

#### Return value

The color of the value to be displayed.

### 7.2.29.5.1.12 SPINBOX\_GetUserData()

#### Description

Prototype explained at the beginning of the chapter as `<WIDGET>_GetUserData()` on page 1165.

### 7.2.29.5.1.13 SPINBOX\_GetValue()

#### Description

Returns the value of the SPINBOX widget.

#### Prototype

```
I32 SPINBOX_GetValue(SPINBOX_Handle hObj);
```

#### Parameters

Parameter	Description
<a href="#">hObj</a>	Handle of the SPINBOX widget.

#### Return value

Value of the SPINBOX widget.

### 7.2.29.5.1.14 SPINBOX\_SetBkColor()

Before	After
	

#### Description

Sets the background color of the SPINBOX widget.

#### Prototype



```
void SPINBOX_SetBkColor(SPINBOX_Handle hObj,
                       unsigned int   Index,
                       GUI_COLOR      Color);
```

#### Parameters

Parameter	Description
<code>hObj</code>	Handle of the SPINBOX widget.
<code>Index</code>	See <i>SPINBOX color indexes</i> on page 2349 for a full list of permitted values.
<code>Color</code>	<code>Color</code> to be used for the background.



### 7.2.29.5.1.15 SPINBOX\_SetButtonBkColor()

Before	After
	

#### Description

Sets the background color of the buttons.

#### Prototype

```
void SPINBOX_SetButtonBkColor(SPINBOX_Handle hObj,
                              unsigned int   Index,
                              GUI_COLOR     Color);
```

#### Parameters

Parameter	Description
<code>hObj</code>	Handle of the SPINBOX widget.
<code>Index</code>	See <i>SPINBOX color indexes</i> on page 2349 for a full list of permitted values.
<code>Color</code>	<code>Color</code> to be used for the background.

### 7.2.29.5.1.16 SPINBOX\_SetButtonSize()

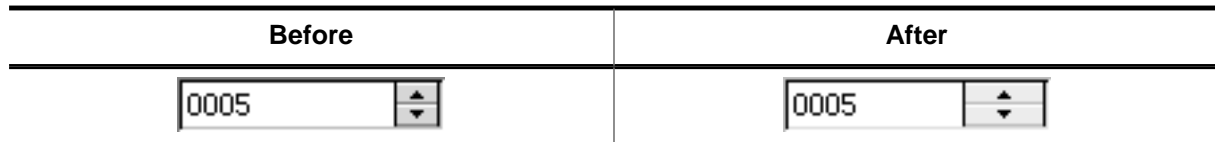

#### Description

Sets the button size of the given SPINBOX widget.

#### Prototype

```
void SPINBOX_SetButtonSize(SPINBOX_Handle hObj,  
                           unsigned      ButtonSize);
```

#### Parameters

Parameter	Description
<code>hObj</code>	Handle of the SPINBOX widget.
<code>ButtonSize</code>	Button size in pixels to be used.

### 7.2.29.5.1.17 SPINBOX\_SetDefaultButtonSize()



#### Description

Sets the default *x*-size of the buttons.

#### Prototype

```
void SPINBOX_SetDefaultButtonSize(U16 ButtonSize);
```

#### Parameters

Parameter	Description
<i>x</i>	New default <i>x</i> -size of the buttons.

#### Additional information

If the default button size is set to 0, the size of the button is determined automatically on creation.

### 7.2.29.5.1.18 SPINBOX\_SetEdge()

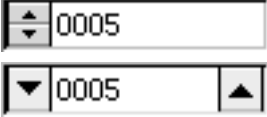
Before	After
	

#### Description

Sets the edge to display the buttons on.

#### Prototype

```
void SPINBOX_SetEdge(SPINBOX_Handle hObj,
                    U8 Edge);
```

#### Parameters

Parameter	Description
<a href="#">hObj</a>	Handle of the SPINBOX widget.
<a href="#">Edge</a>	See <i>SPINBOX edge flags</i> on page 2350 for a full list of permitted values.

### 7.2.29.5.1.19 SPINBOX\_SetEditMode()

#### Description

Sets the spinbox widget to either edit or step mode.

#### Prototype

```
void SPINBOX_SetEditMode(SPINBOX_Handle hObj,  
                        U8 EditMode);
```

#### Parameters

Parameter	Description
<a href="#">hObj</a>	Handle of the SPINBOX widget.
<a href="#">EditMode</a>	See <i>SPINBOX edit mode flags</i> on page 2351.

#### Additional information

The widget supports the 'Step' mode (default) and the 'Edit' mode. 'Step' mode means each time one of the buttons is pressed the value of the box is incremented or decremented by the step value. 'Edit' mode means each single digit can be modified separately. If 'Edit' mode is selected the EDIT field becomes editable and a cursor appears. When pressing a button the focused digit will be incremented or decremented by 1. In 'Edit' mode the EDIT field also accepts digits as keyboard input.

### 7.2.29.5.1.20 SPINBOX\_SetFont()

Before	After
	

#### Description

Sets the font used to display the value.

#### Prototype

```
void SPINBOX_SetFont(      SPINBOX_Handle  hObj,  
                          const GUI_FONT  * pFont);
```

#### Parameters

Parameter	Description
<code>hObj</code>	Handle to the SPINBOX widget.
<code>pFont</code>	Pointer to the font to be used.

### 7.2.29.5.1.21 SPINBOX\_SetRange()

#### Description

Sets the minimum and maximum value.

#### Prototype

```
void SPINBOX_SetRange(SPINBOX_Handle hObj,  
                     I32             Min,  
                     I32             Max);
```

#### Parameters

Parameter	Description
<a href="#">hObj</a>	Handle to the SPINBOX widget.
<a href="#">Min</a>	Minimum value.
<a href="#">Max</a>	Maximum value.

### 7.2.29.5.1.22 SPINBOX\_SetStep()

#### Description

Sets the value to be used for incrementing and decrementing in 'Step' mode.

#### Prototype

```
U16 SPINBOX_SetStep(SPINBOX_Handle hObj,  
                   U16           Step);
```

#### Parameters

Parameter	Description
<a href="#">hObj</a>	Handle to the SPINBOX widget.
<a href="#">Step</a>	Value to be used.

#### Return value

Previous used step value.

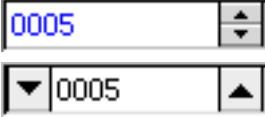

### 7.2.29.5.1.23 SPINBOX\_SetTextColor()

Before	After
	

#### Description

Sets the color of the displayed value.

#### Prototype

```
void SPINBOX_SetTextColor(SPINBOX_Handle hObj,
                          unsigned int   Index,
                          GUI_COLOR      Color);
```

#### Parameters

Parameter	Description
<a href="#">hObj</a>	Handle of the SPINBOX widget.
<a href="#">Index</a>	See <i>SPINBOX color indexes</i> on page 2349 for a full list of permitted values.
<a href="#">Color</a>	<a href="#">Color</a> to be set for the text.

### 7.2.29.5.1.24 SPINBOX\_SetTimerPeriod()

#### Description

This function sets the time it takes before the SPINBOX widget starts increasing or decreasing its value automatically when a button keeps being pressed.

#### Prototype

```
void SPINBOX_SetTimerPeriod(SPINBOX_Handle hObj,  
                             U32           Index,  
                             U32           Period);
```

#### Parameters

Parameter	Description
<a href="#">hObj</a>	Handle of the SPINBOX widget.
<a href="#">Index</a>	Timer index. See <i>SPINBOX timer indexes</i> on page 2352.
<a href="#">Period</a>	Color to be set for the text.

### 7.2.29.5.1.25 SPINBOX\_SetUserData()

#### Description

Prototype explained at the beginning of the chapter as `<WIDGET>_SetUserData()` on page 1166.

### 7.2.29.5.1.26 SPINBOX\_SetValue()

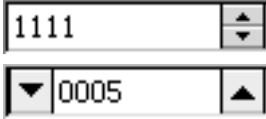
Before	After
	

#### Description

Sets the value of the SPINBOX.

#### Prototype

```
void SPINBOX_SetValue(SPINBOX_Handle hObj,
                     I32 Value);
```

#### Parameters

Parameter	Description
<code>hObj</code>	Handle of the SPINBOX widget.
<code>v</code>	Value to be set.

## 7.2.29.5.2 Defines

### 7.2.29.5.2.1 SPINBOX color indexes

#### Description

Color indexes used for SPINBOX widgets.

#### Definition

```
#define SPINBOX_CI_DISABLED    0
#define SPINBOX_CI_ENABLED    1
#define SPINBOX_CI_PRESSED    2
```

#### Symbols

Definition	Description
<a href="#">SPINBOX_CI_DISABLED</a>	Color for disabled state.
<a href="#">SPINBOX_CI_ENABLED</a>	Color for enabled state.
<a href="#">SPINBOX_CI_PRESSED</a>	Color for pressed state (only for buttons).

### 7.2.29.5.2.2 SPINBOX edge flags

#### Description

Flags used by the routine `SPINBOX_SetEdge()` to define the button placement of a SPINBOX widget.

#### Definition

```
#define SPINBOX_EDGE_RIGHT    0
#define SPINBOX_EDGE_LEFT    1
#define SPINBOX_EDGE_CENTER  2
```

#### Symbols

Definition	Description
<code>SPINBOX_EDGE_RIGHT</code>	Buttons are displayed on the right edge of the widget.
<code>SPINBOX_EDGE_LEFT</code>	Buttons are displayed on the left edge of the widget.
<code>SPINBOX_EDGE_CENTER</code>	Buttons are displayed on the left and right edges of the widget.

### 7.2.29.5.2.3 SPINBOX edit mode flags

#### Description

Flags used for activating edit mode for a SPINBOX widget. For more information, refer to `SPINBOX_SetEditMode()`.

#### Definition

```
#define SPINBOX_EM_STEP    0
#define SPINBOX_EM_EDIT  1
```

#### Symbols

Definition	Description
<a href="#">SPINBOX_EM_STEP</a>	Pressing a button adds or subtracts the step value.
<a href="#">SPINBOX_EM_EDIT</a>	Pressing a button increments or decrements a digit.

#### 7.2.29.5.2.4 SPINBOX timer indexes

##### Description

Timer indexes used by the routine `SPINBOX_SetTimerPeriod()`.

##### Definition

```
#define SPINBOX_TI_TIMERSTART    0
#define SPINBOX_TI_TIMERINC     1
```

##### Symbols

Definition	Description
<a href="#">SPINBOX_TI_TIMERSTART</a>	Time it takes to start auto increase/decrease of its value.
<a href="#">SPINBOX_TI_TIMERINC</a>	Time between two increments/decrements.



## 7.2.29.6 Example

The `Sample` folder contains the following example which shows how the widget can be used:

- `WIDGET_Spinbox.c`

### Screenshot of `WIDGET_Spinbox.c`

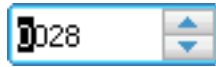

### 7.2.30 SWIPELIST: Swipelists widget

A SWIPELIST widget enables smooth scrolling of a list by swiping over the touchscreen or any other pointer input device (PID). Each SWIPELIST item can show several lines of text and/or a bitmap. It is also possible to assign one or more windows/widgets to each item. When swiping over the touchscreen the list follows the PID. After releasing the PID the list is decelerated smoothly until it stops. The interface of the SWIPELIST allows per default reacting on click-, release- and selection change events.

**Note**

All SWIPELIST-related routines are located in the file(s) SWIPELIST\*.c, SWIPELIST.h. All identifiers are prefixed SWIPELIST.

#### 7.2.30.1 Structure of the SWIPELIST widget

The following diagram shows the detailed structure and look of an item of the SWIPELIST widget:

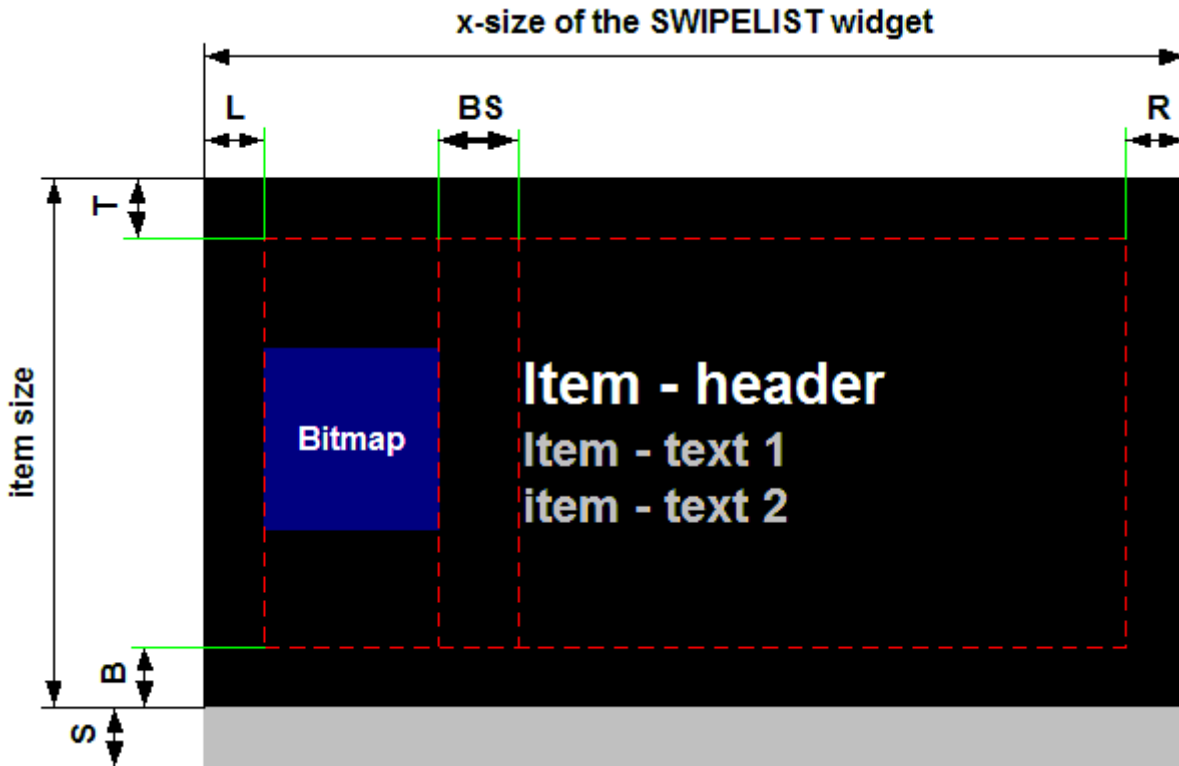

Information about the different diagram indices can be found in the table below.

Details	Description
B	Bottom border used for all items. (Default: 5 pixels)
BS	Size between bitmap and text (bitmap space) used for all items. (Default: 5 pixels)
L	Left border used for all items. (Default: 5 pixels)
R	Right border used for all items. (Default: 5 pixels)
S	Separator line can be set individual for all items. (Default: 1 pixel)
T	Top border used for all items. (Default: 5 pixels)

The following diagram shows the structure and look of a SWIPELIST widget:

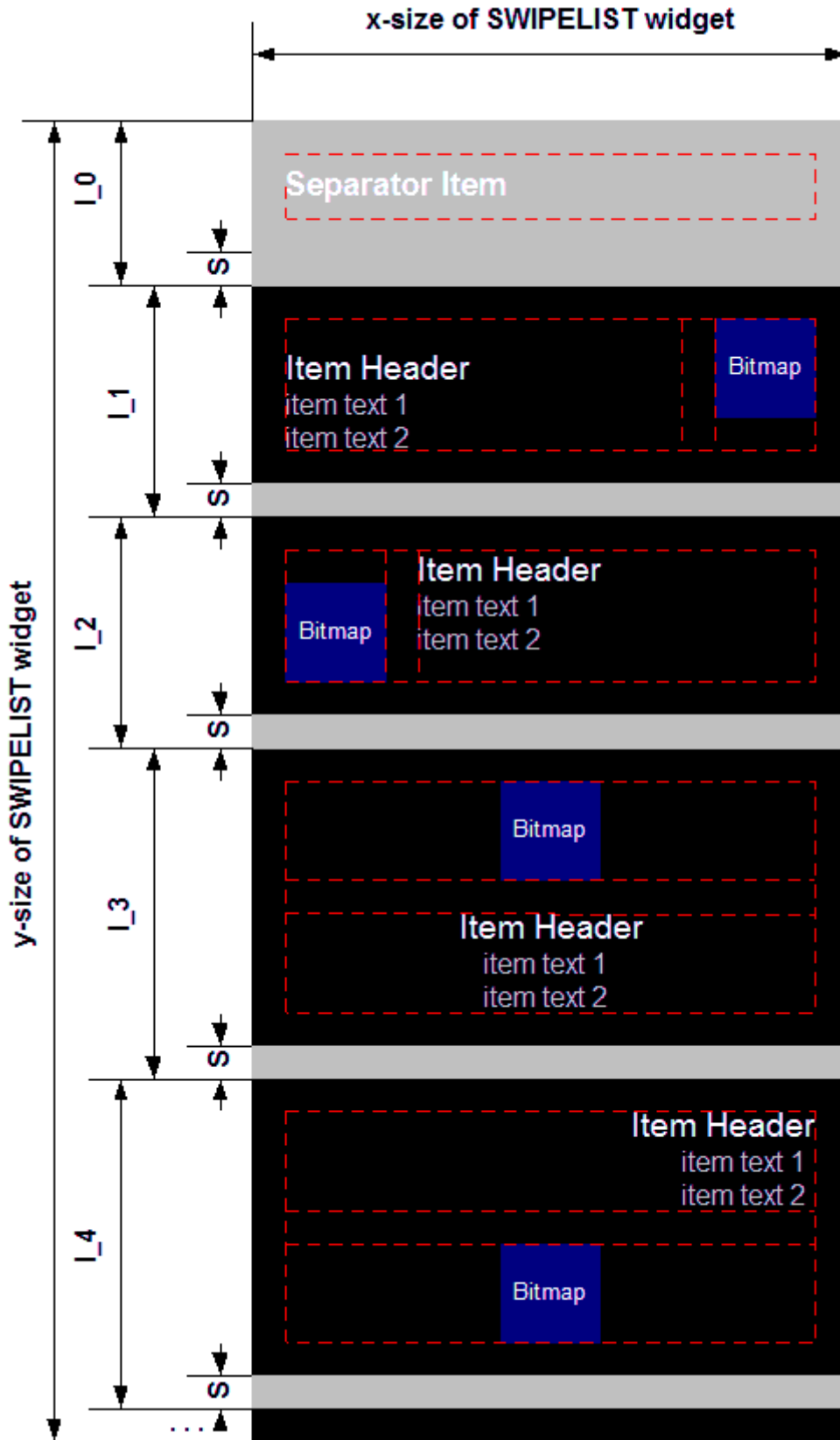

SWIPELIST widgets consists of items. Separator items are items with different properties.

Details	Description
$I_0$	Separator item of SWIPELIST widget. (ItemIndex = 0) + text (alignment: vertical center, left)

Details	Description
I_1	Item of SWIPELIST widget. (ItemIndex = 1) + bitmap (alignment: top, right) + text (alignment: bottom, left)
I_2	Item of SWIPELIST widget. (ItemIndex = 2) + bitmap (alignment: bottom, left) + text (alignment: Top, left)
I_3	Item of SWIPELIST widget. (ItemIndex = 3) + bitmap (alignment: top, horizontal center) + Text (alignment: top, horizontal center)
I_4	Item of SWIPELIST widget. (ItemIndex = 4) + bitmap (alignment: bottom, horizontal center) + text (alignment: bottom, right)
S	Separator line can be set individual for all items. (Default: 1 pixel)

### 7.2.30.2 Difference between separator items and items

Separator items are useful to group items by different topics. They will be drawn (by default) with different fonts and colors.

All API-functions can be used for separator items, too.

	Item	Separator item
<b>Fonts</b>	One font for the header text. One font for the text.	One font for all texts.
<b>Font colors</b>	Two colors for the header text (SEL & UNSEL) Two colors for the text (SEL & UNSEL)	One color for all texts.
<b>Background color</b>	Two colors for background (SEL & UNSEL)	One color for the background.
<b>Selection</b>	One item can be selected at same time. This item change the look (SEL-colors)	Can not be selected.
<b>Notification codes</b>	WM_NOTIFICATION_CLICKED WM_NOTIFICATION_RELEASED WM_NOTIFICATION_SEL_CHANGED	None.

### 7.2.30.3 Configuration options

Type	Macro	Default	Description
N	SWIPELIST_DEFAULT_BITMAP_SPACE	5	Space between text and bitmap.
N	SWIPELIST_DEFAULT_BORDERSIZE_B	5	Border of bottom for items.
N	SWIPELIST_DEFAULT_BORDERSIZE_L	5	Border of left side for items.
N	SWIPELIST_DEFAULT_BORDERSIZE_R	5	Border of right side for items.
N	SWIPELIST_DEFAULT_BORDERSIZE_T	5	Border of top for items.
N	SWIPELIST_DEFAULT_ITEM_BK_COLOR_UNSEL	GUI_BLACK	Background color for unselected items.
N	SWIPELIST_DEFAULT_ITEM_BK_COLOR_SEL	GUI_BLUE	Background color for selected item.

Type	Macro	Default	Description
N	SWIPELIST_DEFAULT_ITEM_HEADER_COLOR_UNSEL	GUI_WHITE	Header text color for unselected items.
N	SWIPELIST_DEFAULT_ITEM_HEADER_COLOR_SEL	GUI_WHITE	Header text color for selected item.
S	SWIPELIST_DEFAULT_ITEM_HEADER_FONT	&GUI_Font16_1	Font for item header text.
N	SWIPELIST_DEFAULT_ITEM_SEP_COLOR	GUI_GRAY	Color of the separator line for items.
N	SWIPELIST_DEFAULT_ITEM_SEP_SIZE	1	Size of the separator line for items.
N	SWIPELIST_DEFAULT_ITEM_TEXT_COLOR_UNSEL	GUI_GRAY	Text color for unselected items.
N	SWIPELIST_DEFAULT_ITEM_TEXT_COLOR_SEL	GUI_GRAY	Text color for selected item.
S	SWIPELIST_DEFAULT_ITEM_TEXT_FONT	&GUI_Font13_1	Font for item text.
N	SWIPELIST_DEFAULT_MIN_MOVE	5	Minimum pixels to start a moving operation.
N	SWIPELIST_DEFAULT_OVERLAP	0	Overlapping distance.
N	SWIPELIST_DEFAULT_PERIOD_OVERLAP	200	Period for automatic moving back when overlap area is entered and released.
N	SWIPELIST_DEFAULT_SEP_ITEM_BK_COLOR	GUI_GRAY	Background color for separator item.
S	SWIPELIST_DEFAULT_SEP_ITEM_FONT	&GUI_Font20_1	Font for separator item.
N	SWIPELIST_DEFAULT_SEP_ITEM_TEXT_COLOR	GUI_WHITE	Text color for separator item.
N	SWIPELIST_DEFAULT_TEXT_ALIGN	GUI_TA_LEFT   GUI_TA_VCENTER	Text alignment for separator items and items.

### 7.2.30.4 Predefined IDs

The following symbols define IDs which may be used to make SWIPELIST widgets distinguishable from creation.

```
#define GUI_ID_SWIPELIST0    0x320
#define GUI_ID_SWIPELIST1    0x321
#define GUI_ID_SWIPELIST2    0x322
#define GUI_ID_SWIPELIST3    0x323
#define GUI_ID_SWIPELIST4    0x324
#define GUI_ID_SWIPELIST5    0x325
#define GUI_ID_SWIPELIST6    0x326
#define GUI_ID_SWIPELIST7    0x327
#define GUI_ID_SWIPELIST8    0x328
#define GUI_ID_SWIPELIST9    0x329
```

### 7.2.30.5 Notification codes

The following events are sent from a SWIPELIST widget to its parent window as part of a WM\_NOTIFY\_PARENT message:

Message	Description
WM_NOTIFICATION_CLICKED	Item of SWIPELIST widget has been clicked.
WM_NOTIFICATION_RELEASED	Item of SWIPELIST widget has been released.
WM_NOTIFICATION_SEL_CHANGED	Item of SWIPELIST widget has been clicked and the pointer has been moved out of the item area.
WM_NOTIFICATION_OVERLAP_TOP_ENTERED	Sent when the overlap area was entered at the top of the SWIPELIST.
WM_NOTIFICATION_OVERLAP_BOTTOM_ENTERED	Sent when the overlap area was entered at the bottom of the SWIPELIST.
WM_NOTIFICATION_OVERLAP_RELEASED	Sent after a dragged overlap area has been released.

### 7.2.30.6 SWIPELIST API

The table below lists the available emWin SWIPELIST-related routines in alphabetical order. Detailed descriptions of the routines follow.

#### Functions

Routine	Description
SWIPELIST_AddItem()	Adds a new item.
SWIPELIST_AddItemText()	Adds a text to the item.
SWIPELIST_AddSepItem()	Adds a new separator item.
SWIPELIST_CreateEx()	Creates a SWIPELIST widget.
SWIPELIST_CreateIndirect()	Creates a SWIPELIST widget from a resource table entry.
SWIPELIST_CreateUser()	Creates a SWIPELIST widget using extra bytes as user data.
SWIPELIST_DeleteItem()	Deletes an item from the SWIPELIST widget.
SWIPELIST_GetBitmap()	Returns a pointer to the optional bitmap of the item.
SWIPELIST_GetBitmapSpace()	Returns the space between text and bitmap.
SWIPELIST_GetBkColor()	Returns the background color.
SWIPELIST_GetBorderSize()	Returns the size of the border.
SWIPELIST_GetDefaultBitmapSpace()	Returns the default space between text and bitmap.
SWIPELIST_GetDefaultBkColor()	Returns the default background color.
SWIPELIST_GetDefaultBorderSize()	Returns the default border size.
SWIPELIST_GetDefaultFont()	Returns a pointer to the default font.
SWIPELIST_GetDefaultOverlap()	Returns the default overlap value used for new widgets.
SWIPELIST_GetDefaultSepColor()	Returns the default color of the separator line.

Routine	Description
<code>SWIPELIST_GetDefaultSepSize()</code>	Returns the default size of the separator line.
<code>SWIPELIST_GetDefaultTextColor()</code>	Returns the default color of the text.
<code>SWIPELIST_GetDefaultTextAlign()</code>	Returns the default alignment of the text.
<code>SWIPELIST_GetDefaultThreshold()</code>	Returns the default threshold value.
<code>SWIPELIST_GetFont()</code>	Returns a pointer to the font.
<code>SWIPELIST_GetItemSize()</code>	Returns the size (in pixels) of the given item.
<code>SWIPELIST_GetItemUserData()</code>	Retrieves the previously stored user data from a given item.
<code>SWIPELIST_GetNumItems()</code>	Returns the number of items.
<code>SWIPELIST_GetNumText()</code>	Returns the number of texts in a item.
<code>SWIPELIST_GetOverlap()</code>	Returns the overlap parameters of the given SWIPELIST widget.
<code>SWIPELIST_GetReleasedItem()</code>	Returns the item index of the last released item.
<code>SWIPELIST_GetScrollPos()</code>	Returns the scroll position of the widget.
<code>SWIPELIST_GetSelItem()</code>	Returns the current selected item index of the given SWIPELIST widget. Returns the current selected item.
<code>SWIPELIST_GetSepColor()</code>	Returns the color of the separator line for the given item.
<code>SWIPELIST_GetSepSize()</code>	Returns the size of the separator line.
<code>SWIPELIST_GetText()</code>	Returns the text of the given item.
<code>SWIPELIST_GetTextAlign()</code>	Returns the text alignment.
<code>SWIPELIST_GetTextColor()</code>	Returns the color of the text.
<code>SWIPELIST_GetThreshold()</code>	Returns the threshold value of the widget.
<code>SWIPELIST_GetUserData()</code>	Retrieves the data set with <code>SWIPELIST_SetUserData()</code> .
<code>SWIPELIST_IsSepItem()</code>	Returns if the given item is a separator item.
<code>SWIPELIST_ItemAttachWindow()</code>	Attaches a window to the item.
<code>SWIPELIST_ItemDetachWindow()</code>	Detaches a window.
<code>SWIPELIST_OwnerDraw()</code>	Default function for drawing the SWIPELIST widget.
<code>SWIPELIST_SetAttachedWindowPos()</code>	Sets the position of an attached window.
<code>SWIPELIST_SetBitmap()</code>	Sets a pointer to the bitmap.
<code>SWIPELIST_SetBitmapSpace()</code>	Sets the space between text and bitmap.
<code>SWIPELIST_SetBkColor()</code>	Sets the background color.
<code>SWIPELIST_SetBorderSize()</code>	Sets the size of the border.
<code>SWIPELIST_SetDefaultBitmapSpace()</code>	Sets the default space between text and bitmap.
<code>SWIPELIST_SetDefaultBkColor()</code>	Sets the default background color.
<code>SWIPELIST_SetDefaultBorderSize()</code>	Sets the default size of the border.
<code>SWIPELIST_SetDefaultFont()</code>	Sets a pointer to the font used as default.
<code>SWIPELIST_SetDefaultOverlap()</code>	Sets the default overlap value used for new widgets.

Routine	Description
<code>SWIPELIST_SetDefaultSepColor()</code>	Sets the default color of the separator line.
<code>SWIPELIST_SetDefaultSepSize()</code>	Sets the default size of the separator line.
<code>SWIPELIST_SetDefaultTextColor()</code>	Sets the default color of the text.
<code>SWIPELIST_SetDefaultTextAlign()</code>	Sets the default alignment of the text.
<code>SWIPELIST_SetDefaultThreshold()</code>	Sets the default threshold value.
<code>SWIPELIST_SetFont()</code>	Sets a pointer to the used font.
<code>SWIPELIST_SetItemSize()</code>	Sets the size of the item.
<code>SWIPELIST_SetItemUserData()</code>	Stores user data in a specific item.
<code>SWIPELIST_SetOverlap()</code>	Enables overlapping for the given SWIPELIST widget.
<code>SWIPELIST_SetOwnerDraw()</code>	Sets the SWIPELIST widget to be owner drawn.
<code>SWIPELIST_SetScrollPos()</code>	Sets the scroll position of the SWIPELIST widget.
<code>SWIPELIST_SetScrollPosItem()</code>	Sets the scroll position to an item.
<code>SWIPELIST_SetSepColor()</code>	Sets the color of a separator line.
<code>SWIPELIST_SetSepSize()</code>	Sets the size of a separator line.
<code>SWIPELIST_SetText()</code>	Sets a text.
<code>SWIPELIST_SetTextAlign()</code>	Sets alignment of the text.
<code>SWIPELIST_SetTextColor()</code>	Sets color of the text.
<code>SWIPELIST_SetThreshold()</code>	Sets the threshold value.
<code>SWIPELIST_SetUserData()</code>	Sets the extra data of a SWIPELIST widget.

## Defines

Group of defines	Description
<code>SWIPELIST background color indexes</code>	Color indexes for the background of SWIPELIST widgets.
<code>SWIPELIST bitmap alignment flags</code>	Flags used for <code>SWIPELIST_SetBitmap()</code> .
<code>SWIPELIST border indexes</code>	Border indexes used for <code>SWIPELIST_SetBorderSize()</code> .
<code>SWIPELIST font indexes</code>	Font indexes for SWIPELIST widgets.
<code>SWIPELIST item color indexes</code>	Color indexes for SWIPELIST widgets.



## 7.2.30.6.1 Functions

### 7.2.30.6.1.1 SWIPELIST\_AddItem()

Before	After

#### Description

Adds a new item with header text to the SWIPELIST widget.

#### Prototype

```
int SWIPELIST_AddItem(    SWIPELIST_Handle  hObj,
                        const char        * sText,
                        int                ItemSize);
```

#### Parameters

Parameter	Description
<code>hObj</code>	Handle of SWIPELIST widget.
<code>sText</code>	Pointer to the text to be handled by the SWIPELIST widget.
<code>ItemSize</code>	Size of the item (in pixels).

#### Return value

0        on success  
1        on error.

#### Additional information

If `ItemSize` is too small for `sText` the item size will be modified by the widget. If `sText` is 0 then no header text will be drawn.

### 7.2.30.6.1.2 SWIPELIST\_AddItemText()

Before	After
<div style="background-color: #333; color: white; padding: 5px;">Data transfer</div> <div style="background-color: #000; color: white; padding: 5px;">Wi-fi Change the Wi-fi settings</div> <div style="background-color: #000; color: white; padding: 5px;">Bluetooth Send/Receive data via Bluetooth</div> <div style="background-color: #000; color: white; padding: 5px;">Data usage</div>	<div style="background-color: #333; color: white; padding: 5px;">Data transfer</div> <div style="background-color: #000; color: white; padding: 5px;">Wi-fi Change the Wi-fi settings</div> <div style="background-color: #000; color: white; padding: 5px;">Bluetooth Send/Receive data via Bluetooth</div> <div style="background-color: #000; color: white; padding: 5px;">Data usage Shows statistic about data transfer</div>

#### Description

Adds a text to the given item of the SWIPELIST widget.

#### Prototype

```
int SWIPELIST_AddItemText(    SWIPELIST_Handle  hObj,
                             unsigned          ItemIndex,
                             const char       * sText);
```

#### Parameters

Parameter	Description
<code>hObj</code>	Handle of SWIPELIST widget.
<code>ItemIndex</code>	Index of an item of the SWIPELIST widget.
<code>sText</code>	Pointer to the text to be handled by the SWIPELIST widget.

#### Return value

0        on success  
1        on error.

#### Additional information

An item can have an undefined number of texts. Each text will begin in a new line. If the size of the items are too small for the new text the item size will be modified by the widget. If *SWIPELIST\_AddItem* on page 2361 does not set a header text then this function will set the header text at first call.

### 7.2.30.6.1.3 SWIPELIST\_AddSepItem()

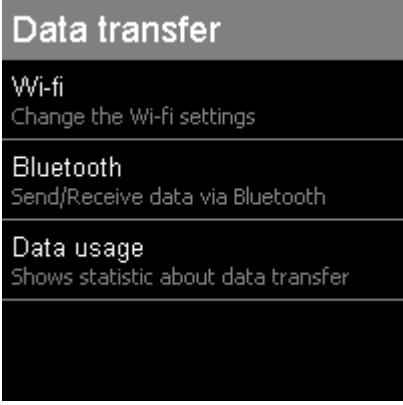
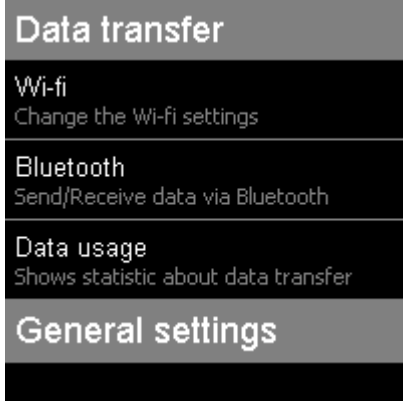
Before	After
	

#### Description

Adds a new separator item to the SWIPELIST widget.

#### Prototype

```
int SWIPELIST_AddSepItem(    SWIPELIST_Handle  hObj,
                           const char      * sText,
                           int              ItemSize);
```

#### Parameters

Parameter	Description
<code>hObj</code>	Handle of SWIPELIST widget.
<code>sText</code>	Pointer to the text to be handled by the SWIPELIST widget.
<code>ItemSize</code>	Size (in pixels) of the item used as separator.

#### Return value

0        on success  
1        on error.

#### Additional information

Separator items do not send any notification messages to the parent window of the SWIPELIST widget. They do not change the style if they are clicked. The separator size of the previous item will be set to 0.

### 7.2.30.6.1.4 SWIPELIST\_CreateEx()

#### Description

Creates a SWIPELIST widget of a specified size at a specified location.

#### Prototype

```
SWIPELIST_Handle SWIPELIST_CreateEx(int    x0,
                                     int    y0,
                                     int    xSize,
                                     int    ySize,
                                     WM_HWIN hParent,
                                     int    WinFlags,
                                     int    ExFlags,
                                     int    Id);
```

#### Parameters

Parameter	Description
<code>x0</code>	X-position of the button relative to the parent window.
<code>y0</code>	Y-position of the button relative to the parent window.
<code>xSize</code>	Horizontal size of the SWIPELIST widget (in pixels).
<code>ySize</code>	Vertical size of the SWIPELIST widget (in pixels).
<code>hParent</code>	Handle of parent window.
<code>WinFlags</code>	Window create flags. In order to make the widget visible immediately <code>WM_CF_SHOW</code> should be used. The complete list of available parameters can be found under <i>Window create flags</i> on page 1146.
<code>ExFlags</code>	Not used yet, reserved for future use.
<code>Id</code>	Window ID of the widget.

#### Return value

Handle of the created SWIPELIST widget; 0 if the function fails.

### 7.2.30.6.1.5 SWIPELIST\_CreateIndirect()

#### Description

The prototype of this function is explained at the beginning of this chapter. Details can be found in the description of the function `<WIDGET>_CreateIndirect()` on page 1161.

### 7.2.30.6.1.6 SWIPELIST\_CreateUser()

#### Description

Prototype explained at the beginning of the chapter as `<WIDGET>_CreateUser()` on page 1162. For a detailed description of the parameters the function `SWIPELIST_CreateEx()` can be referred to.

### 7.2.30.6.1.7 SWIPELIST\_DeleteItem()

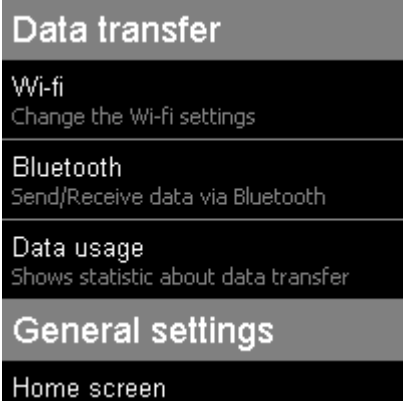
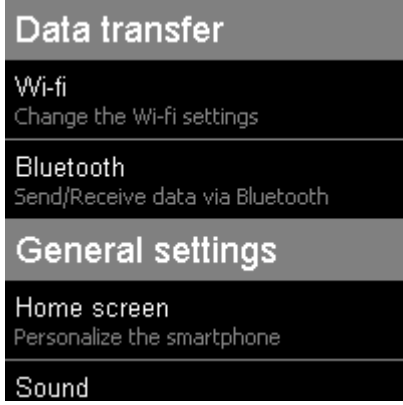
Before	After
	

#### Description

Deletes an item from the SWIPELIST widget.

#### Prototype

```
void SWIPELIST_DeleteItem(SWIPELIST_Handle hObj,
                          unsigned        ItemIndex);
```

#### Parameters

Parameter	Description
<code>hObj</code>	Handle of SWIPELIST widget.
<code>ItemIndex</code>	Index of an item of the SWIPELIST widget.

#### Additional information

If windows are attached to the item, those windows will be deleted, too.

### 7.2.30.6.1.8 SWIPELIST\_GetBitmap()

#### Description

Returns a pointer to the optional bitmap of the item.

#### Prototype

```
GUI_BITMAP *SWIPELIST_GetBitmap(SWIPELIST_Handle hObj,  
                                unsigned         ItemIndex);
```

#### Parameters

Parameter	Description
<code>hObj</code>	Handle of SWIPELIST widget.
<code>ItemIndex</code>	Index of an item of the SWIPELIST widget.

#### Return value

Pointer to the bitmap, 0 if no bitmap exist.



### 7.2.30.6.1.9 SWIPELIST\_GetBitmapSpace()

#### Description

Returns number of pixels used as space between the bitmap and the text of the SWIPELIST widget.

#### Prototype

```
int SWIPELIST_GetBitmapSpace(SWIPELIST_Handle hObj);
```

#### Parameters

Parameter	Description
<a href="#">hObj</a>	Handle of SWIPELIST widget.

#### Return value

Number of pixels between the bitmap and the text.

### 7.2.30.6.1.10 SWIPELIST\_GetBkColor()

#### Description

Returns the specific background color of the SWIPELIST widget.

#### Prototype

```
GUI_COLOR SWIPELIST_GetBkColor(SWIPELIST_Handle hObj,  
                               unsigned          Index);
```

#### Parameters

Parameter	Description
<a href="#">hObj</a>	Handle of SWIPELIST widget.
<a href="#">Index</a>	See <i>SWIPELIST background color indexes</i> on page 2431 for a full list of permitted values.

#### Return value

Specific background color of the SWIPELIST widget.

### 7.2.30.6.1.11 SWIPELIST\_GetBorderSize()

#### Description

Returns the border of the SWIPELIST widget.

#### Prototype

```
int SWIPELIST_GetBorderSize(SWIPELIST_Handle hObj,  
                           unsigned Index);
```

#### Parameters

Parameter	Description
<a href="#">hObj</a>	Handle of SWIPELIST widget.
<a href="#">Index</a>	See <i>SWIPELIST border indexes</i> on page 2433 for a full list of permitted values.

#### Return value

Border size of the SWIPELIST widget.

### 7.2.30.6.1.12 SWIPELIST\_GetDefaultBitmapSpace()

#### Description

Returns the default number of pixels used as space between the bitmap and the text for new SWIPELIST widgets.

#### Prototype

```
int SWIPELIST_GetDefaultBitmapSpace(void);
```

#### Return value

Default number of pixels used as space between the bitmap and the text for new SWIPELIST widgets.

### 7.2.30.6.1.13 SWIPELIST\_GetDefaultBkColor()

#### Description

Returns the specific default background color of the SWIPELIST widget.

#### Prototype

```
GUI_COLOR SWIPELIST_GetDefaultBkColor(unsigned Index);
```

#### Parameters

Parameter	Description
<a href="#">Index</a>	See <i>SWIPELIST background color indexes</i> on page 2431 for a full list of permitted values.

#### Return value

Specific default background color of the SWIPELIST widget.

### 7.2.30.6.1.14 SWIPELIST\_GetDefaultBorderSize()

#### Description

Returns the default border size (in pixels) of new SWIPELIST widgets.

#### Prototype

```
int SWIPELIST_GetDefaultBorderSize(unsigned Index);
```

#### Parameters

Parameter	Description
<a href="#">Index</a>	See <i>SWIPELIST border indexes</i> on page 2433 for a full list of permitted values.

#### Return value

Border size used for new SWIPELIST widgets.

### 7.2.30.6.1.15 SWIPELIST\_GetDefaultFont()

#### Description

Returns a pointer to the specific default font used for new SWIPELIST widgets.

#### Prototype

```
GUI_FONT *SWIPELIST_GetDefaultFont(unsigned Index);
```

#### Parameters

Parameter	Description
<a href="#">Index</a>	See <i>SWIPELIST font indexes</i> on page 2434 for a full list of permitted values.

#### Return value

Pointer to the specific default font used for new SWIPELIST widgets.

### 7.2.30.6.1.16 SWIPELIST\_GetDefaultOverlap()

#### Description

Returns the default overlap value used for new widgets.

#### Prototype

```
unsigned SWIPELIST_GetDefaultOverlap(int * pPeriod,  
                                     U8 * pFlags);
```

#### Parameters

Parameter	Description
<code>pPeriod</code>	<code>out</code> Pointer to store the default overlap period.
<code>pFlags</code>	<code>out</code> Pointer to store the default overlap flags.

#### Return value

The default value for overlapping dragging operations.

#### Additional information

See `SWIPELIST_SetOverlap()` for additional information on overlapping distance.



### 7.2.30.6.1.17 SWIPELIST\_GetDefaultSepColor()

#### Description

Returns the default color of the separator line used for all new items.

#### Prototype

```
GUI_COLOR SWIPELIST_GetDefaultSepColor(void);
```

#### Return value

Default color of the separator line used for all new items.

### 7.2.30.6.1.18 SWIPELIST\_GetDefaultSepSize()

#### Description

Returns the default size (in pixels) of the separator line used for all new items.

#### Prototype

```
unsigned SWIPELIST_GetDefaultSepSize(void);
```

#### Return value

Default size (in pixels) of the separator line used for all new items.

### 7.2.30.6.1.19 SWIPELIST\_GetDefaultTextColor()

#### Description

Returns the specific default text color used by new SWIPELIST widgets.

#### Prototype

```
GUI_COLOR SWIPELIST_GetDefaultTextColor(unsigned Index);
```

#### Parameters

Parameter	Description
<a href="#">Index</a>	See <i>SWIPELIST background color indexes</i> on page 2431 for a full list of permitted values.

#### Return value

Specific default text color used by new SWIPELIST widgets.

### 7.2.30.6.1.20 SWIPELIST\_GetDefaultTextAlign()

#### Description

Returns the default text align for all new items of the SWIPELIST widget.

#### Prototype

```
int SWIPELIST_GetDefaultTextAlign(void);
```

#### Return value

Default text align for all new items of the SWIPELIST widget.

### 7.2.30.6.1.21 SWIPELIST\_GetDefaultThreshold()

#### Description

Returns the default threshold value used for new widgets. Please also refer to the function `SWIPELIST_SetThreshold()`.

#### Prototype

```
int SWIPELIST_GetDefaultThreshold(void);
```

#### Return value

Default threshold value.

### 7.2.30.6.1.22 SWIPELIST\_GetFont()

#### Description

Returns a pointer of the specified font of the SWIPELIST widget.

#### Prototype

```
GUI_FONT *SWIPELIST_GetFont(SWIPELIST_Handle hObj,  
                             unsigned Index);
```

#### Parameters

Parameter	Description
<a href="#">hObj</a>	Handle of SWIPELIST widget.
<a href="#">Index</a>	See <i>SWIPELIST font indexes</i> on page 2434 for a full list of permitted values.

#### Return value

Pointer of the specified font, 0 if index is not correct.

### 7.2.30.6.1.23 SWIPELIST\_GetItemSize()

#### Description

Returns the size (in pixels) of the given item.

#### Prototype

```
int SWIPELIST_GetItemSize(SWIPELIST_Handle hObj,  
                          unsigned ItemIndex);
```

#### Parameters

Parameter	Description
<code>hObj</code>	Handle of SWIPELIST widget.
<code>ItemIndex</code>	Index of an item of the SWIPELIST widget.

#### Return value

Size of the item, -1 if failed.

### 7.2.30.6.1.24 SWIPELIST\_GetItemUserData()

#### Description

Retrieves the previously stored user data from a given item.

#### Prototype

```
U32 SWIPELIST_GetItemUserData(SWIPELIST_Handle hObj,  
                             unsigned ItemIndex);
```

#### Parameters

Parameter	Description
<code>hObj</code>	Handle of SWIPELIST widget.
<code>ItemIndex</code>	Index of an item of the SWIPELIST widget.

#### Return value

User data of the given item.



### 7.2.30.6.1.25 SWIPELIST\_GetNumItems()

#### Description

Returns the number of items in the SWIPELIST widget.

#### Prototype

```
int SWIPELIST_GetNumItems(SWIPELIST_Handle hObj);
```

#### Parameters

Parameter	Description
<a href="#">hObj</a>	Handle of SWIPELIST widget.

#### Return value

Number of items in the SWIPELIST widget.

### 7.2.30.6.1.26 SWIPELIST\_GetNumText()

#### Description

Returns the number of texts in the item of the SWIPELIST widget.

#### Prototype

```
int SWIPELIST_GetNumText(SWIPELIST_Handle hObj,  
                        unsigned ItemIndex);
```

#### Parameters

Parameter	Description
<code>hObj</code>	Handle of SWIPELIST widget.
<code>ItemIndex</code>	Index of an item of the SWIPELIST widget.

#### Return value

Number of texts in the item of the SWIPELIST widget.

#### Additional information

Number of texts added with the function `SWIPELIST_AddItemText()` inclusive the header text added with the function `SWIPELIST_AddItem()`.

### 7.2.30.6.1.27 SWIPELIST\_GetOverlap()

#### Description

Returns the overlap parameters of the given SWIPELIST widget.

#### Prototype

```
unsigned SWIPELIST_GetOverlap(SWIPELIST_Handle hObj,  
                             int * pPeriod,  
                             U8 * pFlags);
```

#### Parameters

Parameter	Description
<code>hObj</code>	Handle of SWIPELIST widget.
<code>pPeriod</code>	<b>out</b> Pointer to store the currently set moving back period.
<code>pFlags</code>	<b>out</b> Pointer to store the currently set overlap flags.

#### Return value

Overlapping value in pixels.

#### Additional information

See `SWIPELIST_SetOverlap()` for additional information on overlapping distance.

### 7.2.30.6.1.28 SWIPELIST\_GetReleasedItem()

#### Description

Returns the item index of the last released item.

#### Prototype

```
int SWIPELIST_GetReleasedItem(SWIPELIST_Handle hObj);
```

#### Parameters

Parameter	Description
<a href="#">hObj</a>	Handle of SWIPELIST widget.

#### Return value

Item index of the last released item, -1 if no item has been released.

### 7.2.30.6.1.29 SWIPELIST\_GetScrollPos()

#### Description

Returns the current scroll position (in pixels) of the SWIPELIST widget.

#### Prototype

```
int SWIPELIST_GetScrollPos(SWIPELIST_Handle hObj);
```

#### Parameters

Parameter	Description
<a href="#">hObj</a>	Handle of SWIPELIST widget.

#### Return value

Current scroll position (in pixels) of the SWIPELIST widget.

### 7.2.30.6.1.30 SWIPELIST\_GetSelItem()

#### Description

Returns the current selected item index of the given SWIPELIST widget.

#### Prototype

```
int SWIPELIST_GetSelItem(SWIPELIST_Handle hObj);
```

#### Parameters

Parameter	Description
<a href="#">hObj</a>	Handle of SWIPELIST widget.

#### Return value

Current selected item index, -1 if currently no item is selected.

### 7.2.30.6.1.31 SWIPELIST\_GetSepColor()

#### Description

Returns the color of the separator line for the given item.

#### Prototype

```
GUI_COLOR SWIPELIST_GetSepColor(SWIPELIST_Handle hObj,  
                                unsigned          ItemIndex);
```

#### Parameters

Parameter	Description
<code>hObj</code>	Handle of SWIPELIST widget.
<code>ItemIndex</code>	Index of an item of the SWIPELIST widget.

#### Return value

Color of the separator line of the given item.

### 7.2.30.6.1.32 SWIPELIST\_GetSepSize()

#### Description

Returns the size (in pixels) of the separator line for the given item.

#### Prototype

```
int SWIPELIST_GetSepSize(SWIPELIST_Handle hObj,  
                        unsigned ItemIndex);
```

#### Parameters

Parameter	Description
<code>hObj</code>	Handle of SWIPELIST widget.
<code>ItemIndex</code>	Index of an item of the SWIPELIST widget.

#### Return value

Size (in pixels) of the separator line for the given item.



### 7.2.30.6.1.33 SWIPELIST\_GetText()

#### Description

Returns the text of the given item.

#### Prototype

```
void SWIPELIST_GetText(SWIPELIST_Handle hObj,  
                      unsigned ItemIndex,  
                      unsigned TextIndex,  
                      char * pBuffer,  
                      int MaxSize);
```

#### Parameters

Parameter	Description
<a href="#">hObj</a>	Handle of SWIPELIST widget.
<a href="#">ItemIndex</a>	Index of an item of the SWIPELIST widget.
<a href="#">TextIndex</a>	Index of an text of an item.
<a href="#">pBuffer</a>	Pointer to buffer filled by the function.
<a href="#">MaxSize</a>	Size of the buffer in bytes.

#### Additional information

The function copies the text of the given item to the buffer given by [pBuffer](#). The maximum number of bytes copied to the buffer is given by [MaxSize](#).

### 7.2.30.6.1.34 SWIPELIST\_GetTextAlign()

#### Description

Returns the text alignment of the given item.

#### Prototype

```
int SWIPELIST_GetTextAlign(SWIPELIST_Handle hObj,  
                           unsigned       ItemIndex);
```

#### Parameters

Parameter	Description
<code>hObj</code>	Handle of SWIPELIST widget.
<code>ItemIndex</code>	Index of an item of the SWIPELIST widget.

#### Return value

Text alignment of the item.

### 7.2.30.6.1.35 SWIPELIST\_GetTextColor()

#### Description

Returns the specific text color of the SWIPELIST widget.

#### Prototype

```
GUI_COLOR SWIPELIST_GetTextColor(SWIPELIST_Handle hObj,  
                                unsigned          Index);
```

#### Parameters

Parameter	Description
<a href="#">hObj</a>	Handle of SWIPELIST widget.
<a href="#">Index</a>	See <i>SWIPELIST item color indexes</i> on page 2435 for a full list of permitted values.

#### Return value

Specific text color of the SWIPELIST widget.

### 7.2.30.6.1.36 SWIPELIST\_GetThreshold()

#### Description

Returns the minimum number of pixels required for a swipe operation.

#### Prototype

```
int SWIPELIST_GetThreshold(SWIPELIST_Handle hObj);
```

#### Parameters

Parameter	Description
<a href="#">hObj</a>	Handle of SWIPELIST widget.

#### Return value

Threshold value used by the widget.

#### Additional information

Please also refer to *SWIPELIST\_SetThreshold* on page 2429.

### 7.2.30.6.1.37 SWIPELIST\_GetUserData()

#### Description

Prototype explained at the beginning of the chapter as `<WIDGET>_GetUserData()` on page 1165.

### 7.2.30.6.1.38 SWIPELIST\_IsSepItem()

#### Description

Returns if the given item is a separator item.

#### Prototype

```
int SWIPELIST_IsSepItem(SWIPELIST_Handle hObj,  
                        U32              ItemIndex);
```

#### Parameters

Parameter	Description
<code>hObj</code>	Handle of SWIPELIST widget.
<code>ItemIndex</code>	Index of an item of the SWIPELIST widget.

#### Return value

- 1 If the item is a separator item.
- 0 If the item is not a separator item.
- 1 Error: Index out of bounds.

### 7.2.30.6.1.39 SWIPELIST\_ItemAttachWindow()

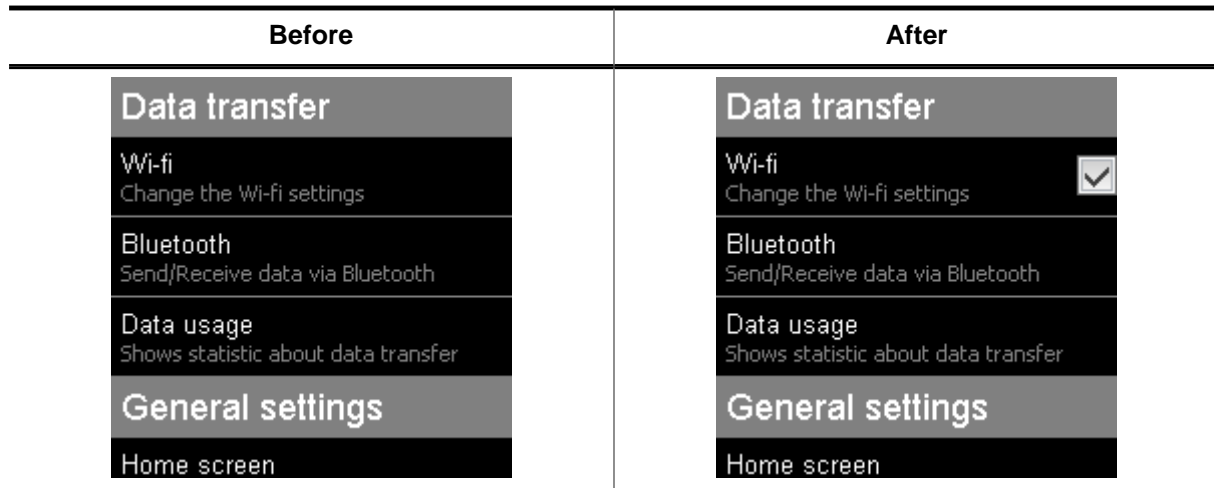

#### Description

Attaches the window/widget to the given item of the SWIPELIST widget.

#### Prototype

```
int SWIPELIST_ItemAttachWindow(SWIPELIST_Handle hObj,
                               unsigned         ItemIndex,
                               WM_HWIN        hWin,
                               int             x0,
                               int             y0);
```

#### Parameters

Parameter	Description
<code>hObj</code>	Handle of SWIPELIST widget.
<code>ItemIndex</code>	Index of an item of the SWIPELIST widget.
<code>hWin</code>	Handle of the window that should be attached.
<code>x0</code>	X-position of the window that should be added to the item.
<code>y0</code>	Y-position of the window that should be added to the item.

#### Return value

0        on success  
1        on error.

#### Additional information

If the size of the window is bigger then the item size the window will not be attached to the item and the function returns 1. If the given position will bring the window out of the item area the position will be fixed to the end of the item area.

### 7.2.30.6.1.40 SWIPELIST\_ItemDetachWindow()

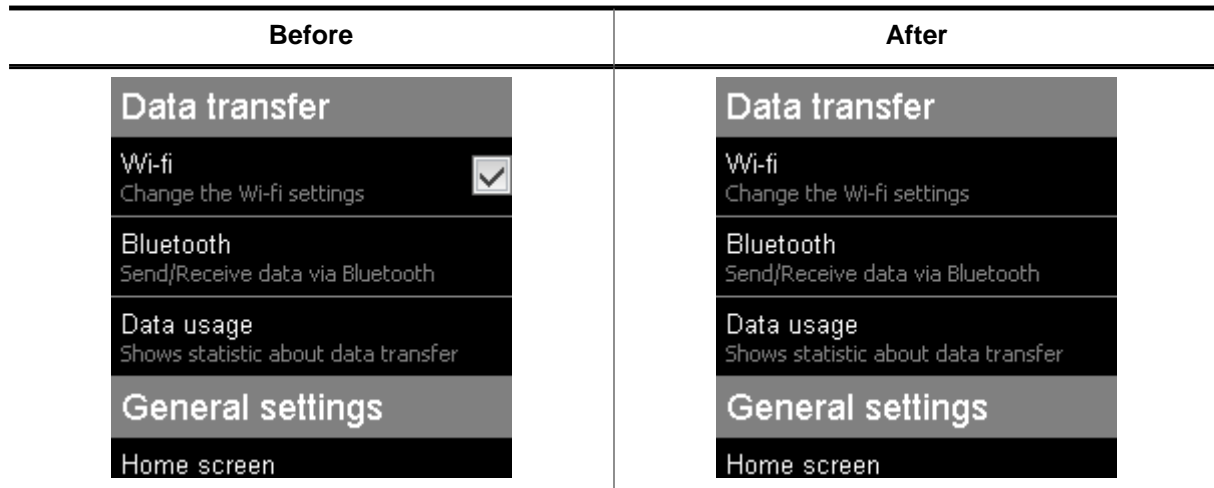

#### Description

Detaches the window from the item of the SWIPELIST widget.

#### Prototype

```
void SWIPELIST_ItemDetachWindow(SWIPELIST_Handle hObj,
                                WM_HWIN          hWin);
```

#### Parameters

Parameter	Description
<a href="#">hObj</a>	Handle of SWIPELIST widget.
<a href="#">hWin</a>	Handle of the window that should be detached.



### 7.2.30.6.1.41 SWIPELIST\_OwnerDraw()

#### Description

Default function to draw an item of the SWIPELIST widget.

#### Prototype

```
int SWIPELIST_OwnerDraw(const WIDGET_ITEM_DRAW_INFO * pDrawItemInfo);
```

#### Parameters

Parameter	Description
<code>pDrawItemInfo</code>	Pointer to a <code>WIDGET_ITEM_DRAW_INFO</code> structure.

#### Additional information

This function is useful if `SWIPELIST_SetOwnerDraw` on page 2421 has been used. It can be used from the application defined drawing function to display anything of the item by the SWIPELIST widget.

### 7.2.30.6.1.42 SWIPELIST\_SetAttachedWindowPos()

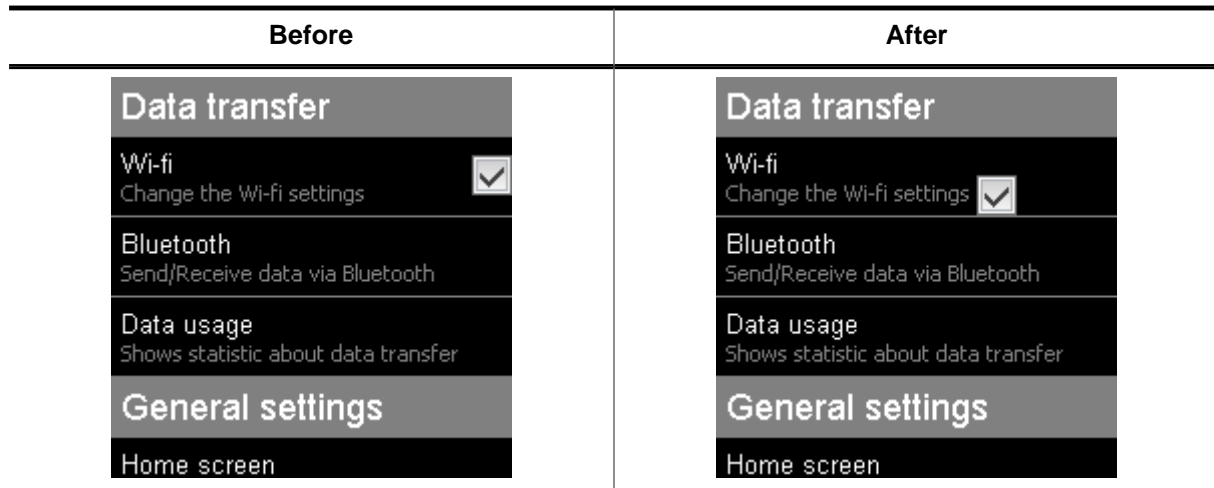

#### Description

Sets the position of the attached window in the item of the SWIPELIST.

#### Prototype

```
void SWIPELIST_SetAttachedWindowPos(SWIPELIST_Handle hObj,
                                     WM_HWIN          hWin,
                                     int              x0,
                                     int              y0);
```

#### Parameters

Parameter	Description
<code>hObj</code>	Handle of SWIPELIST widget.
<code>hWin</code>	Handle of the window that is attached to an item of the SWIPELIST widget.
<code>x0</code>	New x-position of the window that is attached to an item.
<code>y0</code>	New y-position of the window that is attached to an item.

### 7.2.30.6.1.43 SWIPELIST\_SetBitmap()

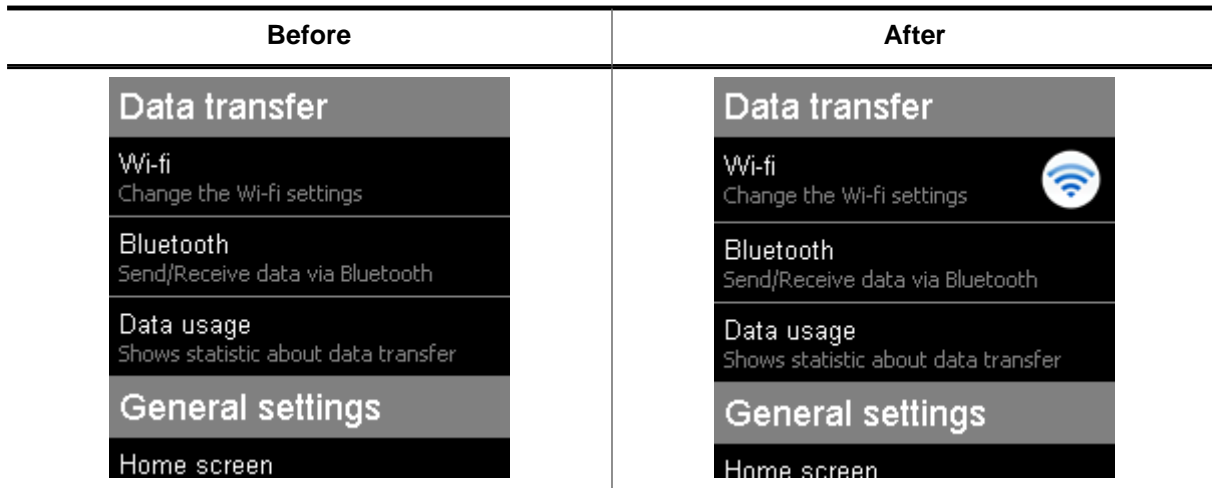

#### Description

Sets a bitmap to be displayed with the given alignment Within the item.

#### Prototype

```
void SWIPELIST_SetBitmap(    SWIPELIST_Handle  hObj,
                           unsigned  ItemIndex,
                           int       Align,
                           const GUI_BITMAP * pBitmap);
```

#### Parameters

Parameter	Description
<code>hObj</code>	Handle of SWIPELIST widget.
<code>ItemIndex</code>	Index of an item of the SWIPELIST widget.
<code>Align</code>	OR-combination of bitmap alignment flags. See <i>SWIPELIST bitmap alignment flags</i> on page 2432.
<code>pBitmap</code>	Pointer to an bitmap structure to be displayed.

#### Additional information

If the alignment of the bitmap is vertical and horizontal central then no text will be displayed.

### 7.2.30.6.1.44 SWIPELIST\_SetBitmapSpace()

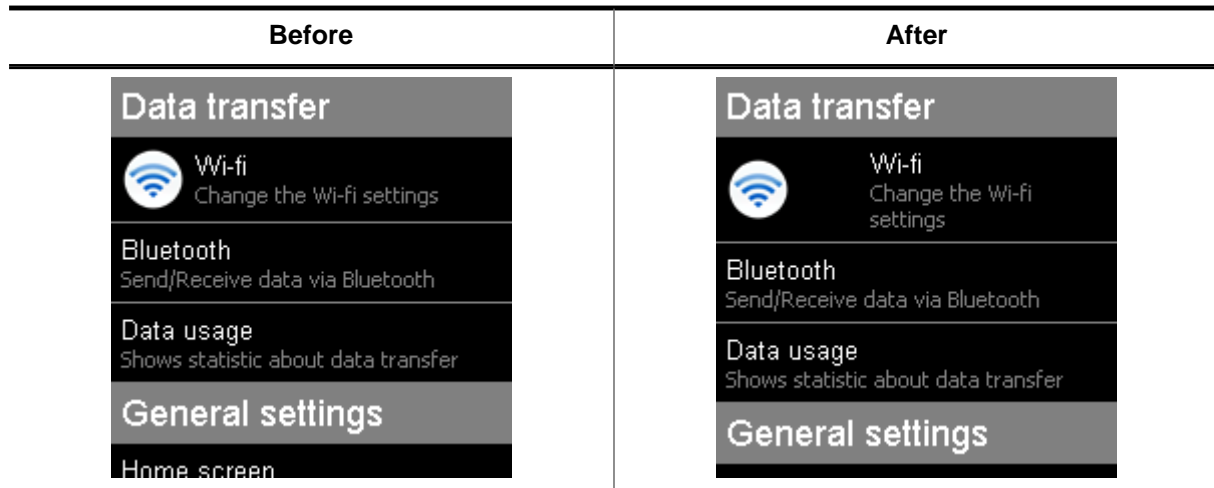

#### Description

Set the space (in pixels) between the text and the bitmap of the SWIPELIST widget.

#### Prototype

```
void SWIPELIST_SetBitmapSpace(SWIPELIST_Handle hObj,
                              unsigned         Size);
```

#### Parameters

Parameter	Description
<a href="#">hObj</a>	Handle of SWIPELIST widget.
<a href="#">Size</a>	Number of pixels used as space.

### 7.2.30.6.1.45 SWIPELIST\_SetBkColor()

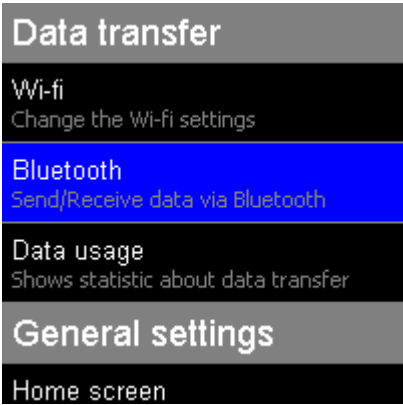
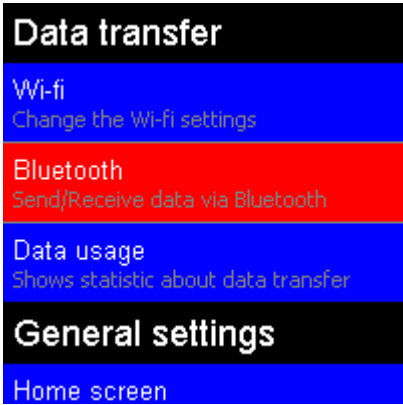
Before	After
	

#### Description

Sets the specific background color of the SWIPELIST widget.

#### Prototype

```
void SWIPELIST_SetBkColor(SWIPELIST_Handle hObj,
                          unsigned Index,
                          GUI_COLOR Color);
```

#### Parameters

Parameter	Description
<code>hObj</code>	Handle of SWIPELIST widget.
<code>Index</code>	See <i>SWIPELIST background color indexes</i> on page 2431 for a full list of permitted values.
<code>Color</code>	Background color to be set.

### 7.2.30.6.1.46 SWIPELIST\_SetBorderSize()

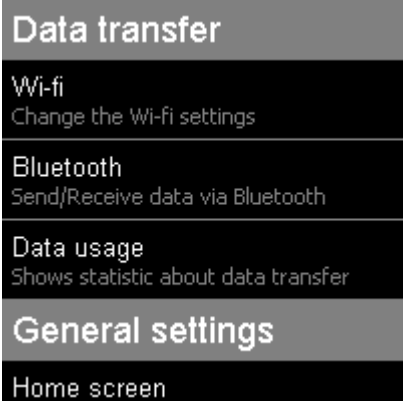
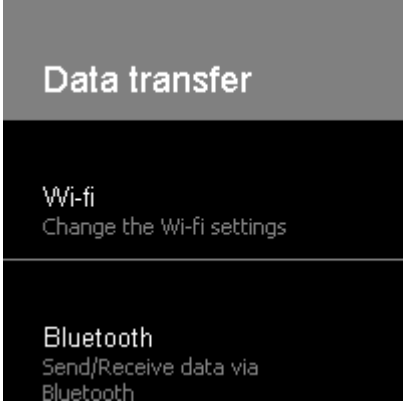
Before	After
	

#### Description

Sets the specific border size (in pixels) of the SWIPELIST widget.

#### Prototype

```
void SWIPELIST_SetBorderSize(SWIPELIST_Handle hObj,
                             unsigned Index,
                             unsigned Size);
```

#### Parameters

Parameter	Description
<a href="#">hObj</a>	Handle of SWIPELIST widget.
<a href="#">Index</a>	See <i>SWIPELIST border indexes</i> on page 2433 for a full list of permitted values.
<a href="#">Size</a>	Number of pixels used as border.

### 7.2.30.6.1.47 SWIPELIST\_SetDefaultBitmapSpace()

#### Description

Sets the default space (in pixels) between text and bitmap for new SWIPELIST widgets.

#### Prototype

```
void SWIPELIST_SetDefaultBitmapSpace(unsigned Size);
```

#### Parameters

Parameter	Description
Size	Number of pixels used as space.

### 7.2.30.6.1.48 SWIPELIST\_SetDefaultBkColor()

#### Description

Sets the default color of the specific background for new SWIPELIST widget.

#### Prototype

```
void SWIPELIST_SetDefaultBkColor(unsigned Index,  
                                GUI_COLOR Color);
```

#### Parameters

Parameter	Description
<a href="#">Index</a>	See <i>SWIPELIST background color indexes</i> on page 2431 for a full list of permitted values.
<a href="#">Color</a>	Background color to be set.



### 7.2.30.6.1.49 SWIPELIST\_SetDefaultBorderSize()

#### Description

Sets the default size (in pixels) of the specific border for new SWIPELIST widgets.

#### Prototype

```
void SWIPELIST_SetDefaultBorderSize(unsigned Index,  
                                     unsigned Size);
```

#### Parameters

Parameter	Description
<a href="#">Index</a>	See <i>SWIPELIST border indexes</i> on page 2433 for a full list of permitted values.
<a href="#">Size</a>	Number of pixels used as border.

### 7.2.30.6.1.50 SWIPELIST\_SetDefaultFont()

#### Description

Sets the pointer to the default font to display the specific text of new SWIPELIST widgets.

#### Prototype

```
void SWIPELIST_SetDefaultFont(    unsigned   Index,  
                                const GUI_FONT * pFont);
```

#### Parameters

Parameter	Description
<a href="#">Index</a>	See <i>SWIPELIST font indexes</i> on page 2434 for a full list of permitted values.
<a href="#">pFont</a>	Pointer to the font to be used.

### 7.2.30.6.1.51 SWIPELIST\_SetDefaultOverlap()

#### Description

Sets the default overlap value used for new widgets.

#### Prototype

```
void SWIPELIST_SetDefaultOverlap(unsigned Overlap,  
                                int      Period,  
                                U8      Flags);
```

#### Parameters

Parameter	Description
Overlap	The new default value to be set for overlapping dragging operations.
Period	Default period to be used for moving back when the list was released while being dragged into overlap area.
Flags	Default overlap flags. WM_MOTION_OVERLAP_TOP to enable overlap at the top edge. WM_MOTION_OVERLAP_BOTTOM to enable overlap at the bottom edge.

#### Additional information

See SWIPELIST\_SetOverlap() for additional information on overlapping distance.

### 7.2.30.6.1.52 SWIPELIST\_SetDefaultSepColor()

#### Description

Sets the default color of the separator line for new items.

#### Prototype

```
void SWIPELIST_SetDefaultSepColor(GUI_COLOR Color);
```

#### Parameters

Parameter	Description
Color	Color of the separator line.

### 7.2.30.6.1.53 SWIPELIST\_SetDefaultSepSize()

#### Description

Sets the default size (in pixels) of the separator line for new items.

#### Prototype

```
void SWIPELIST_SetDefaultSepSize(unsigned Size);
```

#### Parameters

Parameter	Description
Size	Number of pixels used as separator line.

### 7.2.30.6.1.54 SWIPELIST\_SetDefaultTextColor()

#### Description

Sets the default color of the specific text for new SWIPELIST widgets.

#### Prototype

```
void SWIPELIST_SetDefaultTextColor(unsigned Index,  
                                   GUI_COLOR Color);
```

#### Parameters

Parameter	Description
<a href="#">Index</a>	See <i>SWIPELIST item color indexes</i> on page 2435 for a full list of permitted values.
<a href="#">Color</a>	<a href="#">Color</a> used for the specific text.

### 7.2.30.6.1.55 SWIPELIST\_SetDefaultTextAlign()

#### Description

Sets the default text alignment for new items.

#### Prototype

```
void SWIPELIST_SetDefaultTextAlign(int Align);
```

#### Parameters

Parameter	Description
<a href="#">Align</a>	Text alignment to be set (see <a href="#">GUI_SetTextAlign()</a> ).

### 7.2.30.6.1.56 SWIPELIST\_SetDefaultThreshold()

#### Description

Sets the default threshold value to be used for new widgets. For details please also refer to `SWIPELIST_SetThreshold()`.

#### Prototype

```
void SWIPELIST_SetDefaultThreshold(int Threshold);
```

#### Parameters

Parameter	Description
<code>Threshold</code>	The new default value to be set for minimum amount of movement.

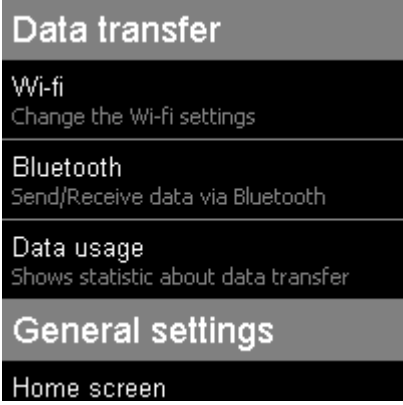
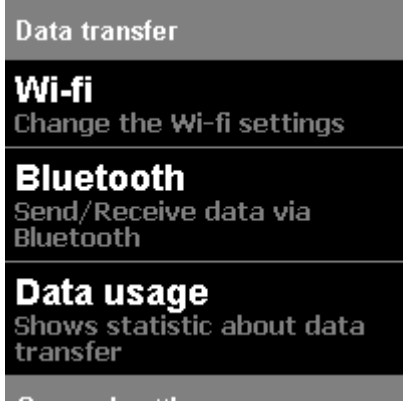

### 7.2.30.6.1.57 SWIPELIST\_SetFont()

Before	After
 <p>Data transfer</p> <p>Wi-fi Change the Wi-fi settings</p> <p>Bluetooth Send/Receive data via Bluetooth</p> <p>Data usage Shows statistic about data transfer</p> <p>General settings</p> <p>Home screen</p>	 <p>Data transfer</p> <p><b>Wi-fi</b> Change the Wi-fi settings</p> <p><b>Bluetooth</b> Send/Receive data via Bluetooth</p> <p><b>Data usage</b> Shows statistic about data transfer</p>

#### Description

Sets the pointer to the font used for display the specific text of the SWIPELIST widget.

#### Prototype

```
void SWIPELIST_SetFont(      SWIPELIST_Handle  hObj,
                             unsigned          Index,
                             const GUI_FONT    * pFont);
```

#### Parameters

Parameter	Description
<a href="#">hObj</a>	Handle of SWIPELIST widget.
<a href="#">Index</a>	See <i>SWIPELIST font indexes</i> on page 2434 for a full list of permitted values.
<a href="#">pFont</a>	Pointer to the font to be used.

### 7.2.30.6.1.58 SWIPELIST\_SetItemSize()

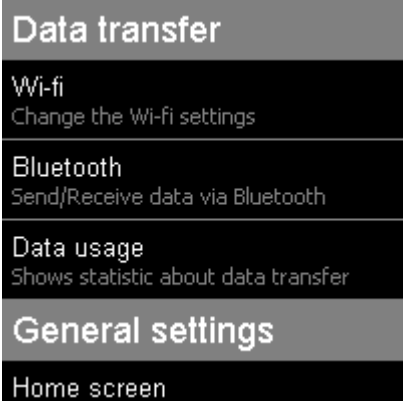
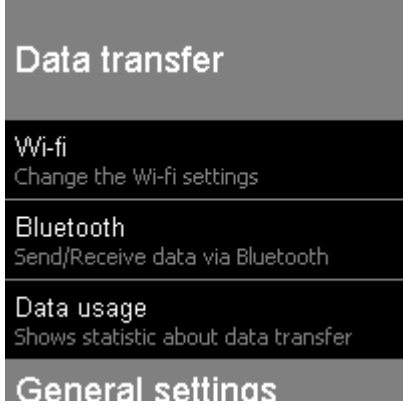
Before	After
	

#### Description

Sets the size of the given item.

#### Prototype

```
void SWIPELIST_SetItemSize(SWIPELIST_Handle hObj,
                           unsigned ItemIndex,
                           unsigned Size);
```

#### Parameters

Parameter	Description
<code>hObj</code>	Handle of SWIPELIST widget.
<code>ItemIndex</code>	Index of an item of the SWIPELIST widget.
<code>Size</code>	Number of pixels used for the item.

### 7.2.30.6.1.59 SWIPELIST\_SetItemUserData()

#### Description

Sets a 32 bit value assigned to the given item of the SWIPELIST widget.

#### Prototype

```
void SWIPELIST_SetItemUserData(SWIPELIST_Handle hObj,  
                               unsigned         ItemIndex,  
                               U32             UserData);
```

#### Parameters

Parameter	Description
<code>hObj</code>	Handle of SWIPELIST widget.
<code>ItemIndex</code>	Index of an item of the SWIPELIST widget.
<code>UserData</code>	32 bit user data to be stored.

### 7.2.30.6.1.60 SWIPELIST\_SetOverlap()

#### Description

Enables overlapping for the given SWIPELIST widget.

When active, the widget also sends notifications to its parent window when the overlapping area is entered and left. See *Notification codes* on page 1142.

#### Prototype

```
void SWIPELIST_SetOverlap(SWIPELIST_Handle hObj,
                          unsigned         Overlap,
                          int              Period,
                          U8                Flags);
```

#### Parameters

Parameter	Description
<code>hObj</code>	Handle of SWIPELIST widget.
<code>Overlap</code>	Overlapping distance in pixels.
<code>Period</code>	<code>Period</code> in ms for moving back the list when it was released after it was dragged into the overlap area.
<code>Flags</code>	OR-combination of overlap flags: <code>WM_MOTION_OVERLAP_TOP</code> to enable overlap on the top edge. <code>WM_MOTION_OVERLAP_BOTTOM</code> to enable overlap on the bottom edge.

#### Additional information

The overlapping value determines how many additional pixels the SWIPELIST can be dragged when the beginning or end of the list is reached. When the list is dragged and released, the list will move back to the normal position.

The table below demonstrates this. The left image shows the list being at the top and in the right image the list is being dragged by the set overlapping distance.

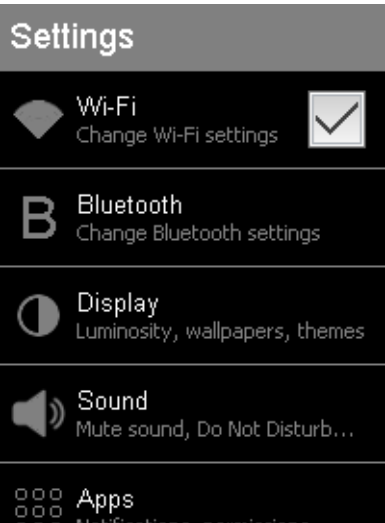
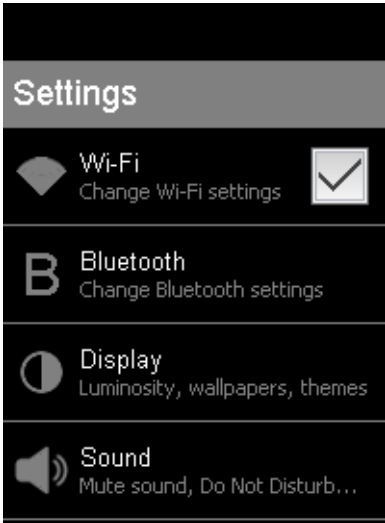
Default	Dragged by overlapping distance
	

### 7.2.30.6.1.61 SWIPELIST\_SetOwnerDraw()

#### Description

Sets the SWIPELIST widget to be owner drawn.

#### Prototype

```
void SWIPELIST_SetOwnerDraw(SWIPELIST_Handle hObj,  
                             WIDGET_DRAW_ITEM_FUNC * pfDrawItem);
```

#### Parameters

Parameter	Description
<a href="#">hObj</a>	Handle of SWIPELIST widget.
<a href="#">pfDrawItem</a>	Pointer to owner draw function.

#### Supported commands

- WIDGET\_ITEM\_DRAW\_BACKGROUND
- WIDGET\_ITEM\_DRAW\_TEXT
- WIDGET\_ITEM\_DRAW\_BITMAP
- WIDGET\_ITEM\_DRAW\_SEP

#### Additional information

This function sets a pointer to a function which will be called by the widget if an item of the SWIPELIST has to be drawn. It gives you the possibility to draw complete customized items. [pfDrawItem](#) is a pointer to an application defined function of type WIDGET\_DRAW\_ITEM\_FUNC which is explained at the beginning of the chapter.

### 7.2.30.6.1.62 SWIPELIST\_SetScrollPos()

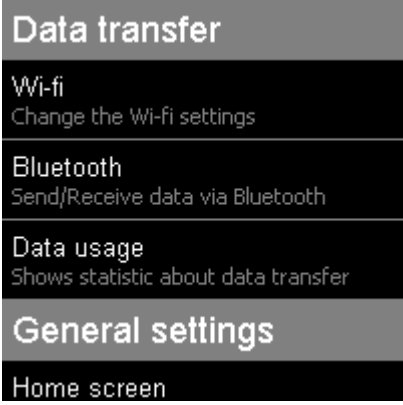
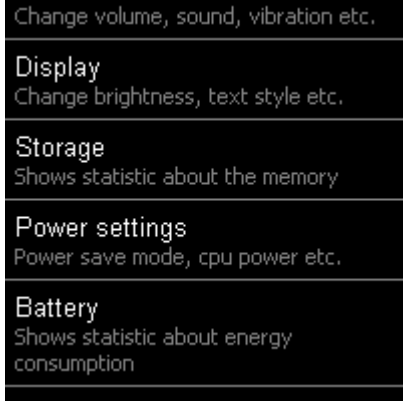
Before	After
 <p><b>Data transfer</b></p> <p>Wi-fi Change the Wi-fi settings</p> <p>Bluetooth Send/Receive data via Bluetooth</p> <p>Data usage Shows statistic about data transfer</p> <p><b>General settings</b></p> <p>Home screen</p>	 <p>Change volume, sound, vibration etc.</p> <p>Display Change brightness, text style etc.</p> <p>Storage Shows statistic about the memory</p> <p>Power settings Power save mode, cpu power etc.</p> <p><b>Battery</b> Shows statistic about energy consumption</p>

#### Description

Sets the scroll position (in pixels) of the SWIPELIST widget.

#### Prototype

```
void SWIPELIST_SetScrollPos(SWIPELIST_Handle hObj,
                           int Pos);
```

#### Parameters

Parameter	Description
<code>hObj</code>	Handle of SWIPELIST widget.
<code>Pos</code>	Number of pixels of the scroll position.

### 7.2.30.6.1.63 SWIPELIST\_SetScrollPosItem()

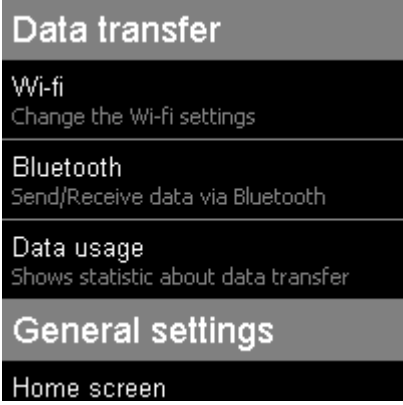
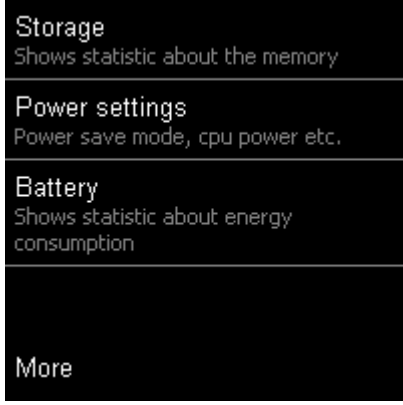
Before	After
 <p><b>Data transfer</b></p> <p>Wi-fi Change the Wi-fi settings</p> <p>Bluetooth Send/Receive data via Bluetooth</p> <p>Data usage Shows statistic about data transfer</p> <p><b>General settings</b></p> <p>Home screen</p>	 <p><b>Storage</b> Shows statistic about the memory</p> <p><b>Power settings</b> Power save mode, cpu power etc.</p> <p><b>Battery</b> Shows statistic about energy consumption</p> <p>More</p>

#### Description

Sets the scroll position to see the given item on first position.

#### Prototype

```
void SWIPELIST_SetScrollPosItem(SWIPELIST_Handle hObj,
                                unsigned         ItemIndex);
```

#### Parameters

Parameter	Description
<code>hObj</code>	Handle of SWIPELIST widget.
<code>ItemIndex</code>	Index of an item of the SWIPELIST widget.

#### Additional information

If the list is too short to set the scroll position to see the given item on first position, the scroll position will be set to the end of the list.

### 7.2.30.6.1.64 SWIPELIST\_SetSepColor()

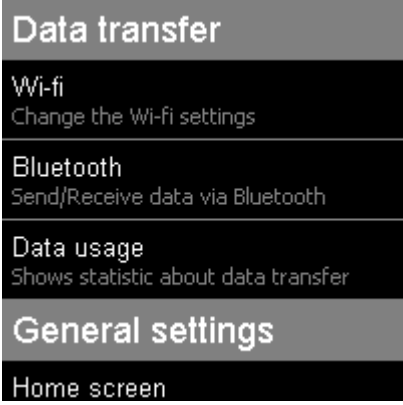
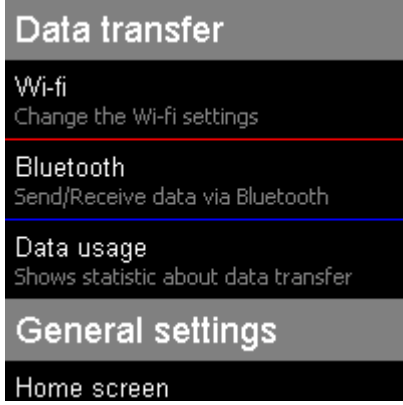
Before	After
 <p><b>Data transfer</b></p> <p>Wi-fi Change the Wi-fi settings</p> <p>Bluetooth Send/Receive data via Bluetooth</p> <p>Data usage Shows statistic about data transfer</p> <p><b>General settings</b></p> <p>Home screen</p>	 <p><b>Data transfer</b></p> <p>Wi-fi Change the Wi-fi settings</p> <p>Bluetooth Send/Receive data via Bluetooth</p> <p>Data usage Shows statistic about data transfer</p> <p><b>General settings</b></p> <p>Home screen</p>

#### Description

Sets the color of the separator line of a given item.

#### Prototype

```
void SWIPELIST_SetSepColor(SWIPELIST_Handle hObj,
                           unsigned         ItemIndex,
                           GUI_COLOR        Color);
```

#### Parameters

Parameter	Description
<code>hObj</code>	Handle of SWIPELIST widget.
<code>ItemIndex</code>	Index of an item of the SWIPELIST widget.
<code>Color</code>	<code>Color</code> of the separator line of a specific item.



### 7.2.30.6.1.65 SWIPELIST\_SetSepSize()

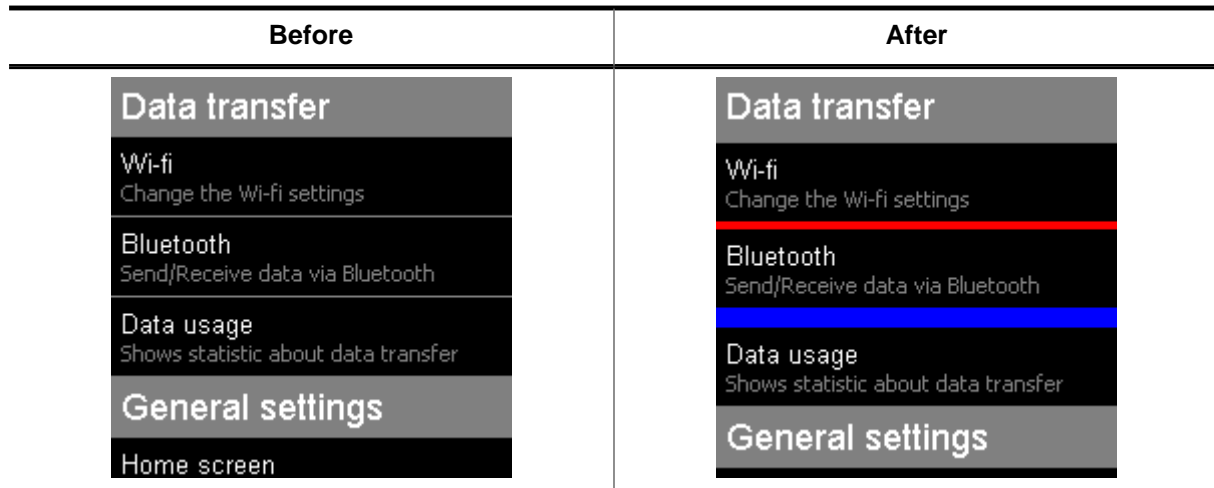

#### Description

Sets size (in pixels) of the separator line of a given item.

#### Prototype

```
void SWIPELIST_SetSepSize(SWIPELIST_Handle hObj,
                          unsigned ItemIndex,
                          int Size);
```

#### Parameters

Parameter	Description
<code>hObj</code>	Handle of SWIPELIST widget.
<code>ItemIndex</code>	Index of an item of the SWIPELIST widget.
<code>Size</code>	Number of pixel used for the size of the separator line.

### 7.2.30.6.1.66 SWIPELIST\_SetText()

Before	After
<div style="background-color: #cccccc; padding: 2px;">Data transfer</div> <div style="background-color: #333333; color: white; padding: 2px;">Wi-fi Change the Wi-fi settings</div> <div style="background-color: #333333; color: white; padding: 2px;">Bluetooth Send/Receive data via Bluetooth</div> <div style="background-color: #333333; color: white; padding: 2px;">Data usage Shows statistic about data transfer</div> <div style="background-color: #cccccc; padding: 2px;">General settings</div> <div style="background-color: #333333; color: white; padding: 2px;">Home screen</div>	<div style="background-color: #cccccc; padding: 2px;">Data transfer</div> <div style="background-color: #333333; color: white; padding: 2px;">Wireless Change the Wi-fi settings</div> <div style="background-color: #333333; color: white; padding: 2px;">Bluetooth Send/Receive data via Bluetooth</div> <div style="background-color: #333333; color: white; padding: 2px;">Data usage Shows statistic about data transfer</div> <div style="background-color: #cccccc; padding: 2px;">General settings</div> <div style="background-color: #333333; color: white; padding: 2px;">Home screen</div>

#### Description

Sets/Changes a text of an item.

#### Prototype

```
void SWIPELIST_SetText(SWIPELIST_Handle  hObj,
                      unsigned          ItemIndex,
                      unsigned          TextIndex,
                      char               * s);
```

#### Parameters

Parameter	Description
<code>hObj</code>	Handle of SWIPELIST widget.
<code>ItemIndex</code>	Index of an item of the SWIPELIST widget.
<code>TextIndex</code>	Index of the text in the item.
<code>sText</code>	Text to be displayed.

### 7.2.30.6.1.67 SWIPELIST\_SetTextAlign()

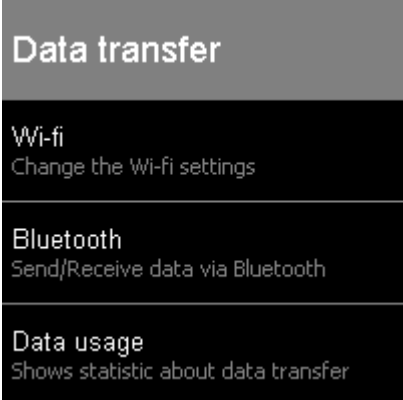
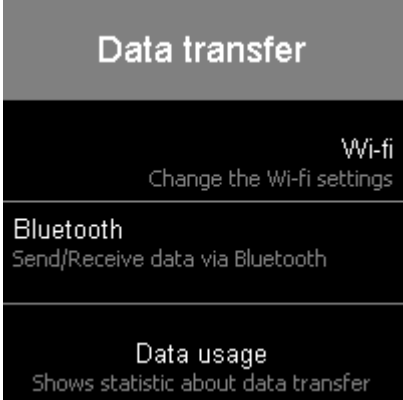
Before	After
 <p>Data transfer</p> <p>Wi-fi Change the Wi-fi settings</p> <p>Bluetooth Send/Receive data via Bluetooth</p> <p>Data usage Shows statistic about data transfer</p>	 <p>Data transfer</p> <p>Wi-fi Change the Wi-fi settings</p> <p>Bluetooth Send/Receive data via Bluetooth</p> <p>Data usage Shows statistic about data transfer</p>

#### Description

Sets the text alignment of a given item.

#### Prototype

```
void SWIPELIST_SetTextAlign(SWIPELIST_Handle hObj,
                           unsigned        ItemIndex,
                           int             Align);
```

#### Parameters

Parameter	Description
<code>hObj</code>	Handle of SWIPELIST widget.
<code>ItemIndex</code>	Index of an item of the SWIPELIST widget.
<code>Align</code>	Text alignment to be set. List of flags can be found under <i>Text alignment flags</i> on page 286.

### 7.2.30.6.1.68 SWIPELIST\_SetTextColor()

Before	After

#### Description

Sets the color of the text used by the SWIPELIST widget.

#### Prototype

```
void SWIPELIST_SetTextColor(SWIPELIST_Handle hObj,
                           unsigned Index,
                           GUI_COLOR Color);
```

#### Parameters

Parameter	Description
<code>hObj</code>	Handle of SWIPELIST widget.
<code>Index</code>	See <i>SWIPELIST item color indexes</i> on page 2435 for a full list of permitted values.
<code>Color</code>	<code>Color</code> for the text.

### 7.2.30.6.1.69 SWIPELIST\_SetThreshold()

#### Description

Sets the minimum distance required for a scroll operation.

#### Prototype

```
int SWIPELIST_SetThreshold(SWIPELIST_Handle hObj,  
                           int Threshold);
```

#### Parameters

Parameter	Description
<code>hObj</code>	Handle of SWIPELIST widget.
<code>Threshold</code>	New threshold value.

#### Return value

Previous threshold value.

#### Additional information

Pressing the PID selects the swipelists item below the PID position. Swiping the PID in pressed state deselects the item and starts the swipe operation. The threshold value defines the minimum number of pixels required to release the selection and start swiping.

### 7.2.30.6.1.70 SWIPELIST\_SetUserData()

#### Description

Prototype explained at the beginning of the chapter as `<WIDGET>_SetUserData()` on page 1166.

## 7.2.30.6.2 Defines

### 7.2.30.6.2.1 SWIPELIST background color indexes

#### Description

Color indexes used for SWIPELIST routines to return or set the background color of SWIPELIST items.

#### Definition

```
#define SWIPELIST_CI_BK_ITEM_UNSEL    0
#define SWIPELIST_CI_BK_ITEM_SEL      1
#define SWIPELIST_CI_BK_SEP_ITEM     2
#define SWIPELIST_CI_BK               3
```

#### Symbols

Definition	Description
<a href="#">SWIPELIST_CI_BK_ITEM_UNSEL</a>	Background of an unselected item.
<a href="#">SWIPELIST_CI_BK_ITEM_SEL</a>	Background of a selected item.
<a href="#">SWIPELIST_CI_BK_SEP_ITEM</a>	Background of a separator item.

### 7.2.30.6.2 SWIPELIST bitmap alignment flags

#### Description

Flags to align the bitmaps of a SWIPELIST widget. These flags are used by the routine `SWIPELIST_SetBitmap()` and can be OR-combined.

#### Definition

```
#define SWIPELIST_BA_LEFT      (0 << 0)
#define SWIPELIST_BA_RIGHT    (1 << 0)
#define SWIPELIST_BA_HCENTER  (2 << 0)
#define SWIPELIST_BA_VCENTER  (3 << 2)
#define SWIPELIST_BA_TOP      (0 << 2)
#define SWIPELIST_BA_BOTTOM   (1 << 2)
```

#### Symbols

Definition	Description
Horizontal alignment	
<code>SWIPELIST_BA_HCENTER</code>	Center X-position.
<code>SWIPELIST_BA_LEFT</code>	Align X-position left (default).
<code>SWIPELIST_BA_RIGHT</code>	Align X-position right.
Vertical alignment	
<code>SWIPELIST_BA_BOTTOM</code>	Align Y-position with bottom pixel line of font.
<code>SWIPELIST_BA_TOP</code>	Align Y-position with top of characters (default).
<code>SWIPELIST_BA_VCENTER</code>	Center Y-position.



### 7.2.30.6.2.3 SWIPELIST border indexes

#### Description

Border indexes to e.g. change the border size of the SWIPELIST widget. A routine that uses these index flags is `SWIPELIST_SetBorderSize()`.

#### Definition

```
#define SWIPELIST_BI_LEFT      0
#define SWIPELIST_BI_RIGHT    1
#define SWIPELIST_BI_TOP      2
#define SWIPELIST_BI_BOTTOM   3
```

#### Symbols

Definition	Description
<a href="#">SWIPELIST_BI_LEFT</a>	Left border of the items.
<a href="#">SWIPELIST_BI_RIGHT</a>	Right border of the items.
<a href="#">SWIPELIST_BI_TOP</a>	Top border of the items.
<a href="#">SWIPELIST_BI_BOTTOM</a>	Bottom border of the items.

#### 7.2.30.6.2.4 SWIPELIST font indexes

##### Description

Font indexes used for SWIPELIST routines.

##### Definition

```
#define SWIPELIST_FI_SEP_ITEM      0
#define SWIPELIST_FI_ITEM_HEADER  1
#define SWIPELIST_FI_ITEM_TEXT    2
```

##### Symbols

Definition	Description
<a href="#">SWIPELIST_FI_SEP_ITEM</a>	Font used by the separator item.
<a href="#">SWIPELIST_FI_ITEM_HEADER</a>	Font used by the header of the item.
<a href="#">SWIPELIST_FI_ITEM_TEXT</a>	Font used by the text of the item.

### 7.2.30.6.2.5 SWIPELIST item color indexes

#### Description

Color indexes used for SWIPELIST routines to return or set the color of an item.

#### Definition

```
#define SWIPELIST_CI_ITEM_HEADER_UNSEL    0
#define SWIPELIST_CI_ITEM_HEADER_SEL     1
#define SWIPELIST_CI_ITEM_TEXT_UNSEL     2
#define SWIPELIST_CI_ITEM_TEXT_SEL       3
#define SWIPELIST_CI_SEP_ITEM_TEXT       4
```

#### Symbols

Definition	Description
SWIPELIST_CI_ITEM_HEADER_UNSEL	Color used for drawing the header text of an unselected item.
SWIPELIST_CI_ITEM_HEADER_SEL	Color used for drawing the header text of a selected item.
SWIPELIST_CI_ITEM_TEXT_UNSEL	Color used for drawing the text for an unselected item.
SWIPELIST_CI_ITEM_TEXT_SEL	Color used for drawing the text of a selected item.
SWIPELIST_CI_SEP_ITEM_TEXT	Color used for drawing the text of a separator item.

## 7.2.30.7 Examples

The `Sample` folder contains the following example which shows how the widget can be used:

- `WIDGET_SwipeList.c`

### Screenshot of `WIDGET_SwipeList.c`

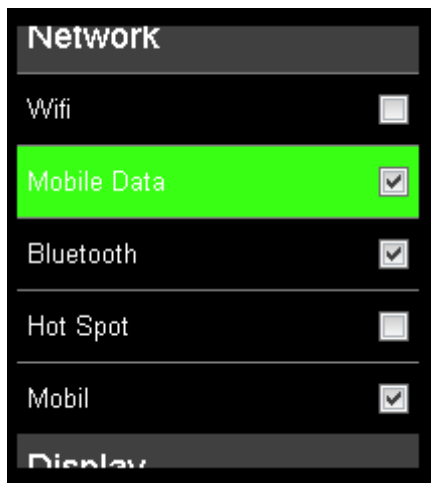

## 7.2.31 SWITCH: Switch widget

A SWITCH widget is a toggleable switch with two states. The widget is similar to the switches seen on most modern smartphones, e.g. in a phone settings application. A SWITCH widget can have two states, a 'left' state when the thumb is on the left and a 'right' state when the thumb is on the right. Optionally, each state has its own text that is shown inside of the switch.

The widget can be clicked to be toggled, or its thumb can be dragged from one side along to the other side, as seen on most smartphones. To be able to drag the thumb, motion support has to be enabled by calling `WM_MOTION_Enable(1)`.



### Note

All SWITCH-related routines are located in the file(s) `SWITCH*.c`, `SWITCH.h`. All identifiers are prefixed `SWITCH`. Memory Devices are required to use the SWITCH widget.

### 7.2.31.1 Configuration options

Type	Macro	Default	Description
N	<code>SWITCH_COLORLEFT_DEFAULT</code>	<code>GUI_BLACK</code>	Text color for text shown in 'left' state.
N	<code>SWITCH_COLORRIGHT_DEFAULT</code>	<code>GUI_BLACK</code>	Text color for text shown in 'right' state.
N	<code>SWITCH_PERIOD_DEFAULT</code>	80	Animation period for a toggle operation.

### 7.2.31.2 Predefined IDs

The following symbols define IDs which may be used to make SWITCH widgets distinguishable from creation.

```
#define GUI_ID_SWITCH0    0x330
#define GUI_ID_SWITCH1    0x331
#define GUI_ID_SWITCH2    0x332
#define GUI_ID_SWITCH3    0x333
#define GUI_ID_SWITCH4    0x334
#define GUI_ID_SWITCH5    0x335
#define GUI_ID_SWITCH6    0x336
#define GUI_ID_SWITCH7    0x337
#define GUI_ID_SWITCH8    0x338
#define GUI_ID_SWITCH9    0x339
```

### 7.2.31.3 Notification codes

The following events are sent from a BUTTON widget to its parent window as part of a `WM_NOTIFY_PARENT` message:

Message	Description
<code>WM_NOTIFICATION_CLICKED</code>	SWITCH has been clicked.
<code>WM_NOTIFICATION_RELEASED</code>	SWITCH has been released.

Message	Description
WM_NOTIFICATION_MOVED_OUT	SWITCH has been clicked and pointer has been moved out of the SWITCH area without releasing.
WM_NOTIFICATION_VALUE_CHANGED	The state of the SWITCH widget has been changed.

## 7.2.31.4 SWITCH API

The table below lists the available SWITCH-related routines in alphabetical order. Detailed descriptions of the routines follow.

### Functions

Routine	Description
<code>SWITCH_AnimState()</code>	Sets the SWITCH widget to the desired state and shows the toggle animation.
<code>SWITCH_CreateIndirect()</code>	Creates a SWITCH widget from a resource table entry.
<code>SWITCH_CreateUser()</code>	Creates a SWITCH widget.
<code>SWITCH_DisableAnimation()</code>	Option for disabling the animation of a SWITCH when clicking the widget.
<code>SWITCH_GetDefaultFont()</code>	Returns the default font for SWITCH widgets.
<code>SWITCH_GetDefaultPeriod()</code>	Returns the default period for SWITCH widgets.
<code>SWITCH_GetDefaultTextColor()</code>	Returns the default text color for SWITCH widgets.
<code>SWITCH_GetState()</code>	Returns the state of a SWITCH widget.
<code>SWITCH_GetUserData()</code>	Retrieves the extra data set with <code>SWITCH_SetUserData()</code> .
<code>SWITCH_SetBitmap()</code>	Sets a bitmap for a state of the SWITCH widget.
<code>SWITCH_SetDefaultFont()</code>	Sets the default font for SWITCH widgets.
<code>SWITCH_SetDefaultPeriod()</code>	Sets the default period for SWITCH widgets.
<code>SWITCH_SetDefaultTextColor()</code>	Sets the default text color for SWITCH widgets.
<code>SWITCH_SetFont()</code>	Sets the font of a SWITCH widget.
<code>SWITCH_SetMode()</code>	Sets the mode of a SWITCH widget.
<code>SWITCH_SetPeriod()</code>	Sets the period to stop the animation of a SWITCH widget.
<code>SWITCH_SetState()</code>	Sets the state of a SWITCH widget.
<code>SWITCH_SetText()</code>	Sets a text on either the left or right side of the SWITCH widget.
<code>SWITCH_SetTextColor()</code>	Sets the text color of a SWITCH widget.
<code>SWITCH_SetThumbSize()</code>	Sets the size of the thumb.
<code>SWITCH_SetUserData()</code>	Sets the extra data of a SWITCH widget.
<code>SWITCH_Toggle()</code>	Toggles the state of a SWITCH widget.

### Defines

Group of defines	Description
<code>SWITCH_bitmap_indexes</code>	Bitmap indexes used by the SWITCH widget.
<code>SWITCH_color_indexes</code>	Color indexes used by the SWITCH widget.
<code>SWITCH_modes</code>	Modes a SWITCH widget can be set to.

<b>Group of defines</b>	<b>Description</b>
<code>SWITCH text indexes</code>	Text indexes used by the SWITCH widget.
<code>SWITCH states</code>	Possible states a SWITCH widget can be in.

## 7.2.31.4.1 Functions

### 7.2.31.4.1.1 SWITCH\_AnimState()

#### Description

Sets the SWITCH widget to the desired state and shows the toggle animation.

#### Prototype

```
void SWITCH_AnimState(SWITCH_Handle hObj,  
                      int           State);
```

#### Parameters

Parameter	Description
<a href="#">hObj</a>	Handle of a SWITCH widget.
<a href="#">State</a>	See table below.



### 7.2.31.4.1.2 SWITCH\_CreateIndirect()

#### Description

The prototype of this function is explained at the beginning of this chapter. Details can be found in the description of the function `<WIDGET>_CreateIndirect()` on page 1161.

### 7.2.31.4.1.3 SWITCH\_CreateUser()

#### Description

Creates a SWITCH widget.

#### Prototype

```
SWITCH_Handle SWITCH_CreateUser(int    x0,
                                int    y0,
                                int    xSize,
                                int    ySize,
                                WM_HWIN hParent,
                                int    WinFlags,
                                int    ExFlags,
                                int    Id,
                                int    NumExtraBytes);
```

#### Parameters

Parameter	Description
<code>x0</code>	Leftmost pixel of the SWITCH widget (in parent coordinates).
<code>y0</code>	Topmost pixel of the SWITCH widget (in parent coordinates).
<code>xSize</code>	Horizontal size of the SWITCH widget (in pixels).
<code>ySize</code>	Vertical size of the SWITCH widget (in pixels).
<code>hParent</code>	Parent window of the SWITCH widget.
<code>WinFlags</code>	Window create flags. Typically <code>WM_CF_SHOW</code> in order to make the widget visible immediately (refer to <i>Window create flags</i> on page 1146 for a list of available parameter values).
<code>ExFlags</code>	Not used yet, reserved for future use.
<code>Id</code>	ID of the SWITCH widget.
<code>NumExtraBytes</code>	Number of extra bytes to be allocated.

#### Return value

Handle of the SWITCH widget.

#### 7.2.31.4.1.4 SWITCH\_DisableAnimation()

##### Description

Option for disabling the animation of a SWITCH when clicking the widget.

##### Prototype

```
void SWITCH_DisableAnimation(SWITCH_Handle hObj,  
                             U8           Disable);
```

##### Parameters

Parameter	Description
<code>hObj</code>	Handle of a SWITCH widget.
<code>Disable</code>	1 for disabling animations, 0 for enabling animations (default).

### 7.2.31.4.1.5 SWITCH\_GetDefaultFont()

#### Description

Returns the default font for SWITCH widgets.

#### Prototype

```
GUI_FONT *SWITCH_GetDefaultFont(void);
```

#### Return value

Default font for SWITCH widgets.

### 7.2.31.4.1.6 SWITCH\_GetDefaultPeriod()

#### Description

Returns the default period for SWITCH widgets. This is the duration of the animation when the SWITCH widget is clicked.

#### Prototype

```
unsigned SWITCH_GetDefaultPeriod(void);
```

#### Return value

Default period for SWITCH widgets.

### 7.2.31.4.1.7 SWITCH\_GetDefaultTextColor()

#### Description

Returns the default text color for SWITCH widgets.

#### Prototype

```
GUI_COLOR SWITCH_GetDefaultTextColor(unsigned Index);
```

#### Parameters

Parameter	Description
<a href="#">Index</a>	Text index. See <i>SWITCH text indexes</i> on page 2465.

#### Return value

Default text color for SWITCH widgets.

### 7.2.31.4.1.8 SWITCH\_GetState()

#### Description

Returns the state of a SWITCH widget.

#### Prototype

```
int SWITCH_GetState(SWITCH_Handle hObj);
```

#### Parameters

Parameter	Description
<a href="#">hObj</a>	Handle of a SWITCH widget.

#### Return value

-1	Invalid state.
SWITCH_STATE_RIGHT	'Right' state.
SWITCH_STATE_LEFT	'Left' state.

### 7.2.31.4.1.9 SWITCH\_GetUserData()

#### Description

Prototype explained at the beginning of the chapter as `<WIDGET>_GetUserData()` on page 1165.



### 7.2.31.4.1.10 SWITCH\_SetBitmap()

#### Description

Sets a bitmap for a state of the SWITCH widget.

#### Prototype

```
void SWITCH_SetBitmap(    SWITCH_Handle  hObj,  
                        unsigned int   Index,  
                        const GUI_BITMAP * pBitmap);
```

#### Parameters

Parameter	Description
<a href="#">hObj</a>	Handle of a SWITCH widget.
<a href="#">Index</a>	See <i>SWITCH bitmap indexes</i> on page 2462.
<a href="#">pBitmap</a>	Pointer to a bitmap.

### 7.2.31.4.1.11 SWITCH\_SetDefaultFont()

#### Description

Sets the default font for SWITCH widgets.

#### Prototype

```
void SWITCH_SetDefaultFont(const GUI_FONT * pFont);
```

#### Parameters

Parameter	Description
<code>pFont</code>	Pointer to a font to be set.

### 7.2.31.4.1.12 SWITCH\_SetDefaultPeriod()

#### Description

Sets the default period for SWITCH widgets.

#### Prototype

```
void SWITCH_SetDefaultPeriod(unsigned Period);
```

#### Parameters

Parameter	Description
<code>Period</code>	<code>Period</code> to be set.

### 7.2.31.4.1.13 SWITCH\_SetDefaultTextColor()

#### Description

Sets the default text color for SWITCH widgets.

#### Prototype

```
void SWITCH_SetDefaultTextColor(GUI_COLOR Color,  
                               unsigned Index);
```

#### Parameters

Parameter	Description
<a href="#">Color</a>	<a href="#">Color</a> to be set.
<a href="#">Index</a>	<a href="#">Color</a> index. See <i>SWITCH color indexes</i> on page 2463.

### 7.2.31.4.1.14 SWITCH\_SetFont()

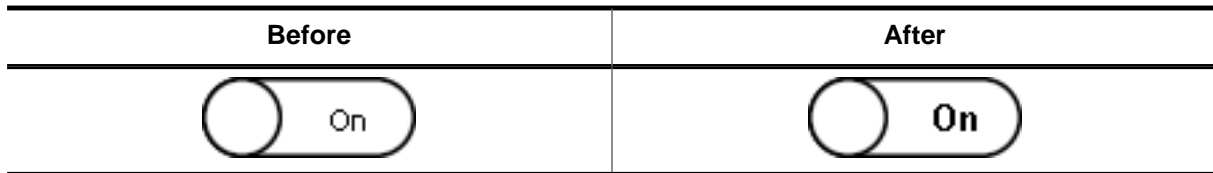

#### Description

Sets the font of a SWITCH widget.

#### Prototype

```
void SWITCH_SetFont(    SWITCH_Handle  hObj,
                      const GUI_FONT  * pFont);
```

#### Parameters

Parameter	Description
hObj	Handle of a SWITCH widget.
pFont	Pointer to a GUI_FONT.

### 7.2.31.4.1.15 SWITCH\_SetMode()

#### Description

Sets the mode of a SWITCH widget. The mode can be set to either disclose mode (default) or fade mode.

#### Prototype

```
void SWITCH_SetMode(SWITCH_Handle hObj,  
                   int Mode);
```

#### Parameters

Parameter	Description
<a href="#">hObj</a>	Handle of a SWITCH widget.
<a href="#">Mode</a>	See <i>SWITCH modes</i> on page 2464.

#### Disclose mode

In disclose mode the bitmap of the new state is disclosed while the old state bitmap disappears under the thumb.



#### Fade mode

In fade mode both state bitmaps are faded into each other.



### 7.2.31.4.1.16 SWITCH\_SetPeriod()

#### Description

Sets the period to stop the animation of a SWITCH widget.

#### Prototype

```
void SWITCH_SetPeriod(SWITCH_Handle hObj,  
                      I32           Period);
```

#### Parameters

Parameter	Description
<code>hObj</code>	Handle of a SWITCH widget.
<code>Period</code>	Animation period. Maximum value: 46340.

### 7.2.31.4.1.17 SWITCH\_SetState()

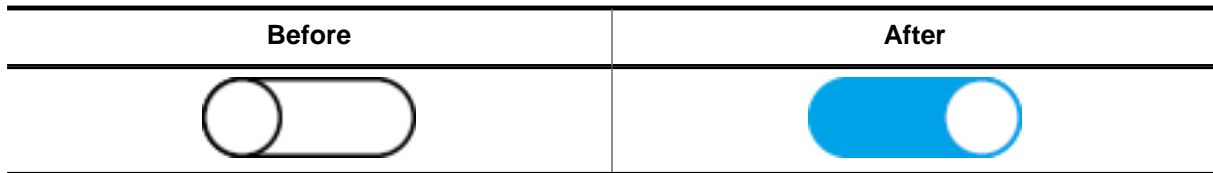

#### Description

Sets the state of a SWITCH widget.

#### Prototype

```
void SWITCH_SetState(SWITCH_Handle hObj,  
                    int State);
```

#### Parameters

Parameter	Description
<code>hObj</code>	Handle of a SWITCH widget.
<code>State</code>	See <i>SWITCH states</i> on page 2466.



### 7.2.31.4.1.18 SWITCH\_SetText()



#### Description

Sets a text on either the left or right side of the SWITCH widget.

#### Prototype

```
int SWITCH_SetText(    SWITCH_Handle  hObj,
                     unsigned int   Index,
                     const char     * pText);
```

#### Parameters

Parameter	Description
<a href="#">hObj</a>	Handle of a SWITCH widget.
<a href="#">Index</a>	Text index. See <i>SWITCH text indexes</i> on page 2465.
<a href="#">pText</a>	Pointer to a string.

#### Return value

- 0      If the routine succeeded.
- 1      If the routine failed.

### 7.2.31.4.1.19 SWITCH\_SetTextColor()

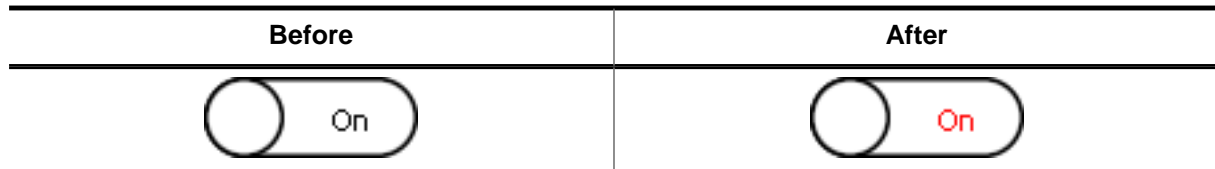

#### Description

Sets the text color of a SWITCH widget.

#### Prototype

```
void SWITCH_SetTextColor(SWITCH_Handle hObj,
                        unsigned int  Index,
                        GUI_COLOR     Color);
```

#### Parameters

Parameter	Description
<code>hObj</code>	Handle of a SWITCH widget.
<code>Index</code>	See <i>SWITCH color indexes</i> on page 2463 for a full list of permitted values.
<code>Color</code>	<code>Color</code> to be used.

### 7.2.31.4.1.20 SWITCH\_SetThumbSize()

#### Description

Sets the size of the thumb.

#### Prototype

```
void SWITCH_SetThumbSize(SWITCH_Handle hObj,  
                          int          xSize,  
                          int          ySize);
```

#### Parameters

Parameter	Description
<code>hObj</code>	Handle of a SWITCH widget.
<code>xSize</code>	<code>xSize</code> of the thumb.
<code>ySize</code>	<code>ySize</code> of the thumb.

#### Additional information

This function is used if the user intends to use the SWITCH without bitmaps. If bitmaps are used the thumb size is taken from the thumb bitmaps.

### 7.2.31.4.1.21 SWITCH\_SetUserData()

#### Description

Prototype explained at the beginning of the chapter as `<WIDGET>_SetUserData()` on page 1166.

### 7.2.31.4.1.22 SWITCH\_Toggle()

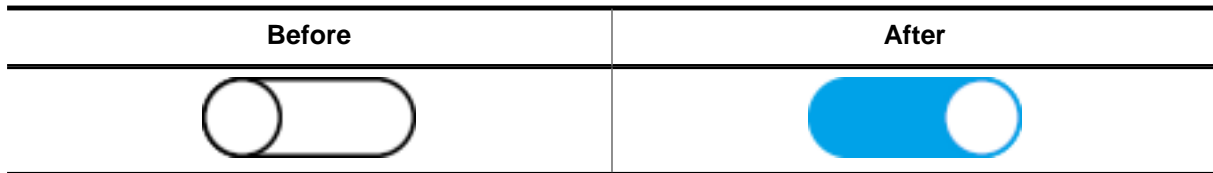

#### Description

Toggles the state of a SWITCH widget.

#### Prototype

```
void SWITCH_Toggle(SWITCH_Handle hObj);
```

#### Parameters

Parameter	Description
<a href="#">hObj</a>	Handle of a SWITCH widget.

## 7.2.31.4.2 Defines

### 7.2.31.4.2.1 SWITCH bitmap indexes

#### Description

Bitmap indexes used by the SWITCH widget for handling bitmaps.

#### Definition

```
#define SWITCH_BI_BK_LEFT          0
#define SWITCH_BI_BK_RIGHT        1
#define SWITCH_BI_BK_DISABLED     2
#define SWITCH_BI_THUMB_LEFT      3
#define SWITCH_BI_THUMB_RIGHT     4
#define SWITCH_BI_THUMB_DISABLED  5
```

#### Symbols

Definition	Description
<a href="#">SWITCH_BI_BK_LEFT</a>	Background bitmap for left state.
<a href="#">SWITCH_BI_BK_RIGHT</a>	Background bitmap for right state.
<a href="#">SWITCH_BI_BK_DISABLED</a>	Background bitmap for disabled state.
<a href="#">SWITCH_BI_THUMB_LEFT</a>	Thumb bitmap for left state.
<a href="#">SWITCH_BI_THUMB_RIGHT</a>	Thumb bitmap for right state.
<a href="#">SWITCH_BI_THUMB_DISABLED</a>	Thumb bitmap for disabled state.

### 7.2.31.4.2.2 SWITCH color indexes

#### Description

Color indexes used by the SWITCH widget.

#### Definition

```
#define SWITCH_CI_LEFT      0
#define SWITCH_CI_RIGHT    1
#define SWITCH_CI_DISABLED 2
```

#### Symbols

Definition	Description
<a href="#">SWITCH_CI_LEFT</a>	Color for left state.
<a href="#">SWITCH_CI_RIGHT</a>	Color for right state.
<a href="#">SWITCH_CI_DISABLED</a>	Color for disabled state.

### 7.2.31.4.2.3 SWITCH modes

#### Description

Modes a SWITCH widget can be set to. See SWITCH\_SetMode() for more information.

#### Definition

```
#define SWITCH_MODE_FADE      (1 << 0)
#define SWITCH_MODE_DISCLOSE (1 << 1)
```

#### Symbols

Definition	Description
<a href="#">SWITCH_MODE_FADE</a>	Fade mode. Both state bitmaps are faded into each other.
<a href="#">SWITCH_MODE_DISCLOSE</a>	Disclose mode. Bitmap of the new state is disclosed.



#### 7.2.31.4.2.4 SWITCH text indexes

##### Description

Text indexes used by the SWITCH widget.

##### Definition

```
#define SWITCH_TI_LEFT    0
#define SWITCH_TI_RIGHT  1
```

##### Symbols

Definition	Description
SWITCH_TI_LEFT	Text shown for the left state.
SWITCH_TI_RIGHT	Text shown for the right state.

### 7.2.31.4.2.5 SWITCH states

#### Description

List of defines of the possible states a SWITCH widget can be in.

#### Definition

```
#define SWITCH_STATE_LEFT    0
#define SWITCH_STATE_RIGHT  1
```

#### Symbols

Definition	Description
<a href="#">SWITCH_STATE_LEFT</a>	Left state, the thumb is on the left side of the widget.
<a href="#">SWITCH_STATE_RIGHT</a>	Right state, the thumb is on the right side of the widget.

## 7.2.32 TEXT: Text widget

Text widgets are typically used in order to display fields of text in dialog boxes, as shown in the message box below:



Of course, text fields may also be used for labeling other widgets, as follows:

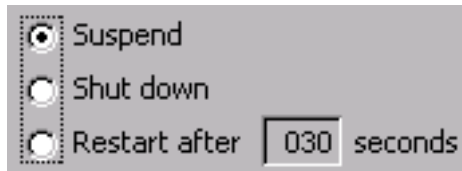

### Note

All TEXT-related routines are located in the file(s) `TEXT*.c`, `TEXT.h`. All identifiers are prefixed `TEXT`.

### 7.2.32.1 Configuration options

Type	Macro	Default	Description
N	<code>TEXT_DEFAULT_BK_COLOR</code>	<code>GUI_INVALID_COLOR</code>	Transparent background per default.
S	<code>TEXT_DEFAULT_ROTATION</code>	<code>GUI_ROTATION_0</code>	Default text rotation.
N	<code>TEXT_DEFAULT_TEXT_COLOR</code>	<code>GUI_BLACK</code>	Default text color.
N	<code>TEXT_DEFAULT_WRAPMODE</code>	<code>GUI_WRAPMODE_NONE</code>	Default wrapping mode.
S	<code>TEXT_FONT_DEFAULT</code>	<code>&amp;GUI_Font13_1</code>	Font used.

### 7.2.32.2 Predefined IDs

The following symbols define IDs which may be used to make TEXT widgets distinguishable from creation.

```
#define GUI_ID_TEXT0    0x160
#define GUI_ID_TEXT1    0x161
#define GUI_ID_TEXT2    0x162
#define GUI_ID_TEXT3    0x163
#define GUI_ID_TEXT4    0x164
#define GUI_ID_TEXT5    0x165
#define GUI_ID_TEXT6    0x166
#define GUI_ID_TEXT7    0x167
#define GUI_ID_TEXT8    0x168
#define GUI_ID_TEXT9    0x169
```

### 7.2.32.3 Notification codes

The following events are sent from a TEXT widget to its parent window as part of a WM\_NOTIFY\_PARENT message:

Message	Description
WM_NOTIFICATION_CLICKED	The widget has been clicked.
WM_NOTIFICATION_RELEASED	The widget has been released.
WM_NOTIFICATION_MOVED_OUT	The pointer was moved out of the widget area while the PID was in pressed state.

### 7.2.32.4 Keyboard reaction

The widget can not gain the input focus and does not react on keyboard input.

### 7.2.32.5 TEXT API

The table below lists the available emWin TEXT-related routines in alphabetical order. Detailed descriptions of the routines follow.

#### Functions

Routine	Description
<code>TEXT_Create()</code>	Creates a TEXT widget. (Obsolete)
<code>TEXT_CreateAsChild()</code>	Creates a TEXT widget as a child window. (Obsolete)
<code>TEXT_CreateEx()</code>	Creates a TEXT widget.
<code>TEXT_CreateIndirect()</code>	Creates a TEXT widget from resource table entry.
<code>TEXT_CreateUser()</code>	Creates a TEXT widget using extra bytes as user data.
<code>TEXT_GetBkColor()</code>	Returns the current background color.
<code>TEXT_GetDefaultFont()</code>	Returns the default font used for TEXT widgets.
<code>TEXT_GetDefaultFrameColor()</code>	Returns the default frame color used for framed fonts.
<code>TEXT_GetDefaultRotation()</code>	Returns the default text rotation mode.
<code>TEXT_GetDefaultTextColor()</code>	Returns the default text color.
<code>TEXT_GetDefaultWrapMode()</code>	Returns the default mode for wrapping text used for TEXT widget. Returns the default mode for wrapping text.
<code>TEXT_GetFont</code>	Returns the default mode for wrapping text used for TEXT widget. Returns the pointer to the font of the TEXT widget.
<code>TEXT_GetFrameColor</code>	Returns the default mode for wrapping text used for TEXT widget.
<code>TEXT_GetNumLines</code>	Returns the default mode for wrapping text used for TEXT widget.
<code>TEXT_GetRotation</code>	Returns the default mode for wrapping text used for TEXT widget.
<code>TEXT_GetText</code>	Returns the default mode for wrapping text used for TEXT widget.
<code>TEXT_GetTextAlign</code>	Returns the default mode for wrapping text used for TEXT widget.

Routine	Description
<code>TEXT_GetTextColor</code>	Returns the default mode for wrapping text used for TEXT widget.
<code>TEXT_GetTextOffset</code>	Returns the default mode for wrapping text used for TEXT widget.
<code>TEXT_GetUserData()</code>	Retrieves the data set with <code>TEXT_SetUserData()</code> .
<code>TEXT_GetWrapMode</code>	Returns the default mode for wrapping text used for TEXT widget. Returns the currently used mode for wrapping text.
<code>TEXT_SetBkColor</code>	Returns the default mode for wrapping text used for TEXT widget. Sets the background color for the text.
<code>TEXT_SetDec</code>	Returns the default mode for wrapping text used for TEXT widget. Sets a value to be displayed.
<code>TEXT_SetDefaultFont()</code>	Sets the default font used for TEXT widgets.
<code>TEXT_SetDefaultFrameColor()</code>	Sets the default frame color used for framed fonts.
<code>TEXT_SetDefaultRotation()</code>	Sets the default rotation mode for new TEXT widgets.
<code>TEXT_SetDefaultTextColor()</code>	Sets the default text color used for TEXT widgets.
<code>TEXT_SetDefaultWrapMode()</code>	Sets the default text wrapping mode used for new TEXT widgets.
<code>TEXT_SetFont</code>	Sets the default text wrapping mode used for new TEXT widgets.
<code>TEXT_SetFrameColor</code>	Sets the default text wrapping mode used for new TEXT widgets.
<code>TEXT_SetRotation</code>	Sets the default text wrapping mode used for new TEXT widgets.
<code>TEXT_SetText</code>	Sets the default text wrapping mode used for new TEXT widgets.
<code>TEXT_SetTextAlign</code>	Sets the default text wrapping mode used for new TEXT widgets.
<code>TEXT_SetTextColor</code>	Sets the default text wrapping mode used for new TEXT widgets.
<code>TEXT_SetTextOffset</code>	Sets the default text wrapping mode used for new TEXT widgets.
<code>TEXT_SetUserData()</code>	Sets the extra data of a TEXT widget.
<code>TEXT_SetWrapMode</code>	Sets the default text wrapping mode used for new TEXT widgets.

## Defines

Group of defines	Description
<code>TEXT create flags</code>	Create flags used by the TEXT widget.

## 7.2.32.5.1 Functions

### 7.2.32.5.1.1 TEXT\_Create

**Note**

This function is **deprecated**, `TEXT_CreateEx()` should be used instead.

### 7.2.32.5.1.2 TEXT\_CreateAsChild

**Note**

This function is **deprecated**, `TEXT_CreateEx()` should be used instead.

### 7.2.32.5.1.3 TEXT\_CreateEx



#### 7.2.32.5.1.4 TEXT\_CreateIndirect

##### Description

The prototype of this function is explained at the beginning of this chapter. Details can be found in the description of the function `<WIDGET>_CreateIndirect()` on page 1161. The element `Para` of the according `GUI_WIDGET_CREATE_INFO` structure is not used. The element `Flags` is used according to the parameter `ExFlags` of the function `TEXT_CreateEx()`.

### 7.2.32.5.1.5 TEXT\_CreateUser

#### Description

Prototype explained at the beginning of the chapter as `<WIDGET>_CreateUser()` on page 1162. For a detailed description of the parameters the function `TEXT_CreateEx()` can be referred to.

### **7.2.32.5.1.6 TEXT\_GetBkColor**

### 7.2.32.5.1.7 TEXT\_GetDefaultFont()

#### Description

Returns the default font used for TEXT widgets.

#### Prototype

```
GUI_FONT *TEXT_GetDefaultFont(void);
```

#### Return value

Pointer to the default font used for TEXT widgets.

### 7.2.32.5.1.8 TEXT\_GetDefaultFrameColor()

#### Description

Returns the default frame color used for framed fonts.

#### Prototype

```
GUI_COLOR TEXT_GetDefaultFrameColor(void);
```

#### Return value

Default frame color.

### 7.2.32.5.1.9 TEXT\_GetDefaultRotation()

#### Description

Returns the default text rotation mode.

#### Prototype

```
GUI_ROTATION *TEXT_GetDefaultRotation(void);
```

#### Return value

Default text rotation mode.

#### Additional information

Refer to *Text rotation modes* on page 288 for a list of possible values.

### 7.2.32.5.1.10 TEXT\_GetDefaultTextColor()

#### Description

Returns the default text color used for TEXT widgets.

#### Prototype

```
GUI_COLOR TEXT_GetDefaultTextColor(void);
```

#### Return value

Default text color.

### 7.2.32.5.1.11 TEXT\_GetDefaultWrapMode()

#### Description

Returns the default mode for wrapping text used for TEXT widget.

#### Prototype

```
GUI_WRAPMODE TEXT_GetDefaultWrapMode(void);
```

#### Return value

Default wrap mode.



**7.2.32.5.1.12 TEXT\_GetFont**

### 7.2.32.5.1.13 TEXT\_GetFrameColor

### **7.2.32.5.1.14 TEXT\_GetNumLines**

### **7.2.32.5.1.15 TEXT\_GetRotation**

**7.2.32.5.1.16 TEXT\_GetText**

### **7.2.32.5.1.17 TEXT\_GetTextAlign**

### **7.2.32.5.1.18 TEXT\_GetTextColor**

### **7.2.32.5.1.19 TEXT\_GetTextOffset**



### 7.2.32.5.1.20 TEXT\_GetUserData

#### Description

Prototype explained at the beginning of the chapter as `<WIDGET>_GetUserData()` on page 1165.

### **7.2.32.5.1.21 TEXT\_GetWrapMode**

### **7.2.32.5.1.22 TEXT\_SetBkColor**

### **7.2.32.5.1.23 TEXT\_SetDec**

### 7.2.32.5.1.24 TEXT\_SetDefaultFont()

#### Description

Sets the default font used for TEXT widgets.

#### Prototype

```
void TEXT_SetDefaultFont(const GUI_FONT * pFont);
```

#### Parameters

Parameter	Description
<code>pFont</code>	Pointer to the font to be set as default.

### 7.2.32.5.1.25 TEXT\_SetDefaultFrameColor()

#### Description

Sets the default frame color used for framed fonts.

#### Prototype

```
void TEXT_SetDefaultFrameColor(GUI_COLOR Color);
```

#### Parameters

Parameter	Description
Color	Color to be used.

### 7.2.32.5.1.26 TEXT\_SetDefaultRotation()

#### Description

Sets the default rotation mode for new TEXT widgets.

#### Prototype

```
GUI_ROTATION *TEXT_SetDefaultRotation(const GUI_ROTATION * pLCD_Api);
```

#### Parameters

Parameter	Description
<a href="#">pLCD_Api</a>	Text rotation mode. See <i>Text rotation modes</i> on page 288 for a list of possible values.

#### Return value

Default text rotation mode.

### 7.2.32.5.1.27 TEXT\_SetDefaultTextColor()

#### Description

Sets the default text color used for TEXT widgets.

#### Prototype

```
void TEXT_SetDefaultTextColor(GUI_COLOR Color);
```

#### Parameters

Parameter	Description
Color	Color to be used.



### 7.2.32.5.1.28 TEXT\_SetDefaultWrapMode()

#### Description

Sets the default text wrapping mode used for new TEXT widgets.

#### Prototype

```
GUI_WRAPMODE TEXT_SetDefaultWrapMode(GUI_WRAPMODE WrapMode);
```

#### Parameters

Parameter	Description
<a href="#">WrapMode</a>	Default text wrapping mode used for new TEXT widgets. See <i>GUI_WRAPMODE</i> on page 290.

#### Return value

Previous default text wrapping mode.

#### Additional information

The default wrapping mode for TEXT widgets is *GUI\_WRAPMODE\_NONE*. For details about text wrapping, refer to *GUI\_DispStringInRectWrap()*.

### **7.2.32.5.1.29 TEXT\_SetFont**

### 7.2.32.5.1.30 TEXT\_SetFrameColor

### **7.2.32.5.1.31 TEXT\_SetRotation**

**7.2.32.5.1.32 TEXT\_SetText**

### **7.2.32.5.1.33 TEXT\_SetTextAlign**

### **7.2.32.5.1.34 TEXT\_SetTextColor**

### **7.2.32.5.1.35 TEXT\_SetTextOffset**



### 7.2.32.5.1.36 TEXT\_SetUserData

#### Description

Prototype explained at the beginning of the chapter as `<WIDGET>_SetUserData()` on page 1166.

### **7.2.32.5.1.37 TEXT\_SetWrapMode**

## 7.2.32.5.2 Defines

### 7.2.32.5.2.1 TEXT create flags

#### Description

Create flags used by the TEXT widget. These flags are used for the `ExFlags` parameter of `TEXT_CreateEx()`.

#### Definition

```
#define TEXT_CF_LEFT      (0)
#define TEXT_CF_HCENTER  (2 << 0)
#define TEXT_CF_RIGHT    (1 << 0)
#define TEXT_CF_TOP      (0)
#define TEXT_CF_VCENTER  (3 << 2)
#define TEXT_CF_BOTTOM   (1 << 2)
```

#### Symbols

Definition	Description
Horizontal alignment	
<code>TEXT_CF_LEFT</code>	Align X-position left.
<code>TEXT_CF_HCENTER</code>	Center X-position.
<code>TEXT_CF_RIGHT</code>	Align X-position right.
Vertical alignment	
<code>TEXT_CF_TOP</code>	Align Y-position with top of characters.
<code>TEXT_CF_VCENTER</code>	Center Y-position.
<code>TEXT_CF_BOTTOM</code>	Align Y-position with bottom pixel line of font.

#### Additional information

These flags are identical to the Text alignment flags and can be used the same way, meaning horizontal and vertical flags can be OR-combined.

## 7.2.32.6 Examples

There is no dedicated example for this widget, since many of the emWin samples use it, for example:

- `DIALOG_Count.c`
- `DIALOG_Radio.c`
- `WIDGET_GraphXY.c`

## 7.2.33 TICKER: Ticker widget

Ticker widgets are used to present multiple information in a moving text. The text is scrolling from right to left.

### Note

All TICKER-related routines are located in the file(s) `TICKER*.c`, `TICKER.h`. All identifiers are prefixed `TICKER`.

### 7.2.33.1 Configuration options

Type	Macro	Default	Description
N	TICKER_DEFAULT_BK_COLOR	GUI_INVALID_COLOR	Transparent background per default.
N	TICKER_DEFAULT_TEXT_COLOR	GUI_BLACK	Black text color used as default.
N	TICKER_DEFAULT_FRAME_COLOR	GUI_WHITE	White text frame used as default.
N	TICKER_DEFAULT_TICKDIST	50	Default tick distance.
N	TICKER_DEFAULT_PERIOD	1000	Default animation period.
N	TICKER_DEFAULT_DIST	30	Default distance between items.
N	TICKER_DEFAULT_TICK_ANIM_SLICE_TIME	40	Default time slice of animations.
S	TICKER_FONT_DEFAULT	&GUI_Font13_1	Default font.

### 7.2.33.2 Predefined IDs

The following symbols define IDs which may be used to make TICKER widgets distinguishable from creation.

```
#define GUI_ID_TICKER0    0x410
#define GUI_ID_TICKER1    0x411
#define GUI_ID_TICKER2    0x412
#define GUI_ID_TICKER3    0x413
#define GUI_ID_TICKER4    0x414
#define GUI_ID_TICKER5    0x415
#define GUI_ID_TICKER6    0x416
#define GUI_ID_TICKER7    0x417
#define GUI_ID_TICKER8    0x418
#define GUI_ID_TICKER9    0x419
```

### 7.2.33.3 Notification codes

The following events are sent from a TICKER widget to its parent window as part of a WM\_NOTIFY\_PARENT message:

Message	Description
WM_NOTIFICATION_CLICKED	The widget has been clicked.
WM_NOTIFICATION_RELEASED	The widget has been released.
WM_NOTIFICATION_MOVED_OUT	The pointer was moved out of the widget area while the PID was in pressed state.
WM_NOTIFICATION_VALUE_CHANGED	The first visible item has changed.

### 7.2.33.4 Keyboard reaction

The widget can not gain the input focus and does not react on keyboard input.

### 7.2.33.5 TICKER API

The table below lists the available emWin TICKER-related routines in alphabetical order. Detailed descriptions of the routines follow.

#### Functions

Routine	Description
TICKER_CreateUser()	Creates a TICKER widget using extra bytes as user data.
TICKER_CreateIndirect()	Creates a TICKER widget from resource table entry.
TICKER_GetBkColor()	Returns the current background color.
TICKER_GetCurrentItemIndex()	Returns the current item index.
TICKER_GetClickedItemIndex()	Returns the last clicked item index.
TICKER_GetDefaultAnimDist()	Returns the default distance used for the TICKER animation.
TICKER_GetDefaultAnimPeriod()	Returns the default period used for the TICKER animation.
TICKER_GetDefaultBkColor()	Returns the default background color used for TICKER widgets.
TICKER_GetDefaultDist()	Returns the default distance between two TICKER text items.
TICKER_GetDefaultFont()	Returns the default font used for TICKER widgets.
TICKER_GetDefaultFrameColor()	Returns the default frame color used for framed fonts.
TICKER_GetDefaultTextColor()	Returns the default text color used for TICKER widgets.
TICKER_GetFont()	Returns a pointer to the font used to display the text of the given TICKER widget.
TICKER_GetItemText()	Copies the text of the given TICKER widget to the given buffer.
TICKER_GetTextAlign()	Returns the alignment of the given TICKER widget.
TICKER_GetTextColor()	Returns the text color of the given TICKER widget.
TICKER_GetFrameColor()	Returns the frame color used for framed fonts of the given TICKER widget.
TICKER_GetUserData()	Retrieves the data set with TICKER_SetUserData().

<b>Routine</b>	<b>Description</b>
<code>TICKER_MoveToItem()</code>	Moves to the given item with an animation.
<code>TICKER_MoveToNextItem()</code>	Moves to the next item with an animation.
<code>TICKER_MoveToPrevItem()</code>	Moves to the previous item with an animation.
<code>TICKER_SetBkColor()</code>	Sets the background color of the TICKER widget.
<code>TICKER_SetConsecutive()</code>	Sets the background color of the TICKER widget.
<code>TICKER_SetContinuousMode()</code>	Used to set widget into continuous mode.
<code>TICKER_SetCurrentItemIndex()</code>	Sets the current item being display at first.
<code>TICKER_SetDefaultAnimDist()</code>	Sets the default distance used for TICKER widget animation.
<code>TICKER_SetDefaultAnimPeriod()</code>	Sets the default period used for TICKER widget animation.
<code>TICKER_SetDefaultBkColor()</code>	Sets the default background color used for TICKER widgets.
<code>TICKER_SetDefaultDist()</code>	Sets the default distance between two TICKER text items.
<code>TICKER_SetDefaultFont()</code>	Sets the default font used for TICKER widgets.
<code>TICKER_SetDefaultFrameColor()</code>	Sets the default frame color used for framed fonts.
<code>TICKER_SetDefaultTextColor()</code>	Sets the default text color used for TICKER widgets.
<code>TICKER_SetFont()</code>	Sets the font to be used for a specified TICKER widget.
<code>TICKER_SetFrameColor()</code>	Sets the frame color for fonts of a specified TICKER widget.
<code>TICKER_SetItemDist()</code>	Sets the distance between two items.
<code>TICKER_SetItems()</code>	Sets the text to be used for a specified TICKER widget.
<code>TICKER_SetItemText()</code>	Sets the text to be used for a specified TICKER widget.
<code>TICKER_SetMovement()</code>	Sets movement properties of the TICKER widget.
<code>TICKER_SetTextAlign()</code>	Sets the text alignment of a specified TICKER widget.
<code>TICKER_SetTextColor()</code>	Sets the text color of a specified TICKER widget.
<code>TICKER_SetWrapMode()</code>	Sets the wrapping mode of the TICKER widget.
<code>TICKER_Start()</code>	Starts the TICKER.
<code>TICKER_Stop()</code>	Stops the TICKER.
<code>TICKER_SetUserData()</code>	Sets extra data of a TICKER widget.

## 7.2.33.5.1 Functions

### 7.2.33.5.1.1 TICKER\_CreateIndirect()

#### Description

The prototype of this function is explained at the beginning of this chapter. Details can be found in the description of the function `<WIDGET>_CreateIndirect()` on page 1161. The element `Para` of the according `GUI_WIDGET_CREATE_INFO` structure is not used. The element `Flags` is used according to the parameter `ExFlags` of the function `TICKER_CreateUser()`.



### 7.2.33.5.1.2 TICKER\_CreateUser()

#### Description

Prototype explained at the beginning of the chapter as `<WIDGET>_CreateUser()` on page 1162.

### 7.2.33.5.1.3 TICKER\_GetBkColor()

#### Description

Returns the current background color of the given TICKER widget.

#### Prototype

```
GUI_COLOR TICKER_GetBkColor(TICKER_Handle hObj);
```

#### Parameters

Parameter	Description
<a href="#">hObj</a>	Handle of TICKER widget.

#### Return value

The current background color.

#### 7.2.33.5.1.4 TICKER\_GetCurrentItemIndex()

##### Description

Returns the current item index.

##### Prototype

```
U32 TICKER_GetCurrentItemIndex(TICKER_Handle hObj);
```

##### Parameters

Parameter	Description
<a href="#">hObj</a>	Handle of the TICKER widget.

##### Return value

Index of the current item.

### 7.2.33.5.1.5 TICKER\_GetClickedItemIndex()

#### Description

Returns the last clicked item index.

#### Prototype

```
U32 TICKER_GetClickedItemIndex(TICKER_Handle hObj);
```

#### Parameters

Parameter	Description
<a href="#">hObj</a>	Handle of the TICKER widget.

#### Return value

Index of the last clicked item.

### 7.2.33.5.1.6 TICKER\_GetDefaultAnimDist()

#### Description

Returns the default distance used for the TICKER animation.

#### Prototype

```
U16 TICKER_GetDefaultAnimDist(void);
```

#### Return value

Default distance used for the TICKER animation.

### 7.2.33.5.1.7 TICKER\_GetDefaultAnimPeriod()

#### Description

Returns the default period used for the TICKER animation.

#### Prototype

```
int TICKER_GetDefaultAnimPeriod(void);
```

#### Return value

Default period used for the TICKER animation.

### 7.2.33.5.1.8 TICKER\_GetDefaultBkColor()

#### Description

Returns the default background color used for TICKER widgets.

#### Prototype

```
GUI_COLOR TICKER_GetDefaultBkColor(void);
```

#### Return value

Default background color.

### 7.2.33.5.1.9 TICKER\_GetDefaultDist()

#### Description

Returns the default distance between two TICKER text items.

#### Prototype

```
U16 TICKER_GetDefaultDist(void);
```

#### Return value

Default distance between two TICKER items.



### 7.2.33.5.1.10 TICKER\_GetDefaultFont()

#### Description

Returns the default font used for TICKER widgets.

#### Prototype

```
GUI_FONT *TICKER_GetDefaultFont(void);
```

#### Return value

Pointer to the default font used for TICKER widgets.

### 7.2.33.5.1.11 TICKER\_GetDefaultFrameColor()

#### Description

Returns the default frame color used for framed fonts.

#### Prototype

```
GUI_COLOR TICKER_GetDefaultFrameColor(void);
```

#### Return value

Default frame color.

### 7.2.33.5.1.12 TICKER\_GetDefaultTextColor()

#### Description

Returns the default text color used for TICKER widgets.

#### Prototype

```
GUI_COLOR TICKER_GetDefaultTextColor(void);
```

#### Return value

Default text color.

### 7.2.33.5.1.13 TICKER\_GetFont()

#### Description

Returns a pointer to the font used to display the text of the given TICKER widget.

#### Prototype

```
GUI_FONT *TICKER_GetFont(TICKER_Handle hObj);
```

#### Parameters

Parameter	Description
<a href="#">hObj</a>	Handle of TICKER widget.

#### Return value

Pointer to the font used to display the text of the given TICKER widget.

### 7.2.33.5.1.14 TICKER\_GetItemText()

#### Description

Copies the text of the given TICKER widget to the given buffer. The 0-Byte at the end of the string is written in any case.

#### Prototype

```
int TICKER_GetItemText(TICKER_Handle hObj,  
                      char * pDest,  
                      U32 BufferSize,  
                      U32 ItemIndex);
```

#### Parameters

Parameter	Description
<code>hObj</code>	Handle of the TICKER widget.
<code>pDest</code>	Pointer to a user defined buffer.
<code>BufferSize</code>	Size of the buffer.

#### Return value

Number of bytes copied.

### 7.2.33.5.1.15 TICKER\_GetTextAlign()

#### Description

Returns the alignment of the given TICKER widget.

#### Prototype

```
int TICKER_GetTextAlign(TICKER_Handle hObj);
```

#### Parameters

Parameter	Description
<a href="#">hObj</a>	Handle of the TICKER widget.

#### Return value

Alignment of the text.

### 7.2.33.5.1.16 TICKER\_GetTextColor()

#### Description

Returns the text color of the given TICKER widget.

#### Prototype

```
GUI_COLOR TICKER_GetTextColor(TICKER_Handle hObj);
```

#### Parameters

Parameter	Description
<a href="#">hObj</a>	Handle of the TICKER widget.

#### Return value

Text color of the given TICKER widget.

### 7.2.33.5.1.17 TICKER\_GetFrameColor()

#### Description

Returns the frame color used for framed fonts of the given TICKER widget.

#### Prototype

```
GUI_COLOR TICKER_GetFrameColor(TICKER_Handle hObj);
```

#### Parameters

Parameter	Description
<a href="#">hObj</a>	Handle of the TICKER widget.

#### Return value

Frame color of the given TICKER widget.



### 7.2.33.5.1.18 TICKER\_GetUserData()

#### Description

Prototype explained at the beginning of the chapter as `<WIDGET>_GetUserData()` on page 1165.

### 7.2.33.5.1.19 TICKER\_SetBkColor()

#### Description

Sets the background color of the TICKER widget.

#### Prototype

```
void TICKER_SetBkColor(TICKER_Handle hObj,  
                      GUI_COLOR      Color);
```

#### Parameters

Parameter	Description
<code>hObj</code>	Handle of TICKER widget.
<code>Color</code>	<code>Color</code> to be used for the background. (range 0x000000 and 0xFFFFFFFF or a valid color define) <code>GUI_INVALID_COLOR</code> to make background transparent

#### Additional information

The background of this widget can either be filled with any available color or transparent. If a valid RGB color is specified, the background is filled with the color, otherwise the background (typically the content of the parent window) is visible. If the background is transparent, the widget is treated as transparent window, otherwise as non-transparent window. Note that using a background color allows more efficient (faster) rendering.

### 7.2.33.5.1.20 TICKER\_SetConsecutive()

#### Description

Sets the background color of the TICKER widget.

#### Prototype

```
void TICKER_SetConsecutive(TICKER_Handle hObj,  
                           int           OnOff);
```

#### Parameters

Parameter	Description
<code>hObj</code>	Handle of TICKER widget.
<code>OnOff</code>	1 to turn consecutive mode on 0 to turn consecutive mode off

#### Additional information

This function has only an effect when the widget is in continuous mode.

### 7.2.33.5.1.21 TICKER\_SetContinuousMode()

#### Description

Used to set widget into continuous mode.

#### Prototype

```
void TICKER_SetContinuousMode(TICKER_Handle hObj);
```

#### Parameters

Parameter	Description
<a href="#">hObj</a>	Handle of TICKER widget.

### 7.2.33.5.1.22 TICKER\_SetCurrentItemIndex()

#### Description

Sets the current item being display at first.

#### Prototype

```
void TICKER_SetCurrentItemIndex(TICKER_Handle hObj,  
                                U32          ItemIndex);
```

#### Parameters

Parameter	Description
<code>hObj</code>	Handle of the TICKER widget.
<code>ItemIndex</code>	Index of the item to be shown.

### 7.2.33.5.1.23 TICKER\_SetDefaultAnimDist()

#### Description

Sets the default distance used for TICKER widget animation.

#### Prototype

```
void TICKER_SetDefaultAnimDist(U16 AnimDist);
```

#### Parameters

Parameter	Description
<a href="#">AnimDist</a>	Distance used for TICKER animations.

### 7.2.33.5.1.24 TICKER\_SetDefaultAnimPeriod()

#### Description

Sets the default period used for TICKER widget animation.

#### Prototype

```
void TICKER_SetDefaultAnimPeriod(int AnimPeriod);
```

#### Parameters

Parameter	Description
<code>AnimPeriod</code>	Period used for TICKER animations.

### 7.2.33.5.1.25 TICKER\_SetDefaultBkColor()

#### Description

Sets the default background color used for TICKER widgets.

#### Prototype

```
void TICKER_SetDefaultBkColor(GUI_COLOR Color);
```

#### Parameters

Parameter	Description
Color	Color to be used for the background.



### 7.2.33.5.1.26 TICKER\_SetDefaultDist()

#### Description

Sets the default distance between two TICKER text items.

#### Prototype

```
void TICKER_SetDefaultDist(U16 Dist);
```

#### Parameters

Parameter	Description
<code>Dist</code>	Distance between two TICKER items.

### 7.2.33.5.1.27 TICKER\_SetDefaultFont()

#### Description

Sets the default font used for TICKER widgets.

#### Prototype

```
void TICKER_SetDefaultFont(const GUI_FONT * pFont);
```

#### Parameters

Parameter	Description
<code>pFont</code>	Pointer to the font to be set as default.

### 7.2.33.5.1.28 TICKER\_SetDefaultFrameColor()

#### Description

Sets the default frame color used for framed fonts.

#### Prototype

```
void TICKER_SetDefaultFrameColor(GUI_COLOR Color);
```

#### Parameters

Parameter	Description
Color	Color to be used.

### 7.2.33.5.1.29 TICKER\_SetDefaultTextColor()

#### Description

Sets the default text color used for TICKER widgets.

#### Prototype

```
void TICKER_SetDefaultTextColor(GUI_COLOR Color);
```

#### Parameters

Parameter	Description
Color	Color to be used.

### 7.2.33.5.1.30 TICKER\_SetFont()

#### Description

Sets the font to be used for a specified TICKER widget.

#### Prototype

```
void TICKER_SetFont(    TICKER_Handle  hObj,  
                      const GUI_FONT  * pFont);
```

#### Parameters

Parameter	Description
<code>hObj</code>	Handle of TICKER widget.
<code>pFont</code>	Pointer to the font to be used.

### 7.2.33.5.1.31 TICKER\_SetFrameColor()

#### Description

Sets the frame color for fonts of a specified TICKER widget.

#### Prototype

```
void TICKER_SetFrameColor(TICKER_Handle hObj,  
                          GUI_COLOR     Color);
```

#### Parameters

Parameter	Description
<code>hObj</code>	Handle of TICKER widget.
<code>Color</code>	New frame color.

### 7.2.33.5.1.32 TICKER\_SetItemDist()

#### Description

Sets the distance between two items

#### Prototype

```
void TICKER_SetItemDist(TICKER_Handle hObj,  
                        int           Dist);
```

#### Parameters

Parameter	Description
<code>hObj</code>	Handle of TICKER widget.
<code>Dist</code>	Distance between two items

### 7.2.33.5.1.33 TICKER\_SetItems()

#### Description

Sets the text to be used for a specified TICKER widget.

#### Prototype

```
int TICKER_SetItems(    TICKER_Handle    hObj,  
                      const char      ** ppStrings,  
                      U32              NumItems);
```

#### Parameters

Parameter	Description
<a href="#">hObj</a>	Handle of TICKER widget.
<a href="#">ppStrings</a>	List of string to be added
<a href="#">NumItems</a>	Number items in the list

#### Return value

0        on success  
1        on error.



### 7.2.33.5.1.34 TICKER\_SetItemText()

#### Description

Sets the text to be used for a specified TICKER widget.

#### Prototype

```
int TICKER_SetItemText(    TICKER_Handle  hObj,  
                          const char      * s,  
                          U32             ItemIndex);
```

#### Parameters

Parameter	Description
<a href="#">hObj</a>	Handle of TICKER widget.
<a href="#">s</a>	Text to be displayed.
<a href="#">ItemIndex</a>	Index of item to be changed

#### Return value

0        on success  
1        on error.

### 7.2.33.5.1.35 TICKER\_SetMovement()

#### Description

Sets movement properties of the TICKER widget.

#### Prototype

```
void TICKER_SetMovement(TICKER_Handle hObj,
                       int           Dist,
                       int           Period);
```

#### Parameters

Parameter	Description
<code>hObj</code>	Handle of TICKER widget.
<code>Dist</code>	Distance in pixel to be moved in the given time (continous mode). Time to next item auto mode (animated mode).
<code>Period</code>	Time it takes to move the given distance (continous mode). Time it takes to move from one item to the next (animated mode).

#### Additional information

If animated mode is used only the scond parameter "`Period`" is used. In continous mode both are used.

Restarts ongoing animation.

### 7.2.33.5.1.36 TICKER\_SetTextAlign()

#### Description

Sets the text alignment of a specified TICKER widget.

#### Prototype

```
void TICKER_SetTextAlign(TICKER_Handle hObj,  
                        int            Align);
```

#### Parameters

Parameter	Description
<code>hObj</code>	Handle of TICKER widget.
<code>Align</code>	Text alignment.

### 7.2.33.5.1.37 TICKER\_SetTextColor()

#### Description

Sets the text color of a specified TICKER widget.

#### Prototype

```
void TICKER_SetTextColor(TICKER_Handle hObj,  
                        GUI_COLOR      Color);
```

#### Parameters

Parameter	Description
<code>hObj</code>	Handle of TICKER widget.
<code>Color</code>	New text color.

### 7.2.33.5.1.38 TICKER\_SetWrapMode()

#### Description

Sets the wrapping mode of the TICKER widget.

#### Prototype

```
void TICKER_SetWrapMode(TICKER_Handle hObj,  
                        GUI_WRAPMODE WrapMode);
```

#### Parameters

Parameter	Description
<a href="#">hObj</a>	Handle of TICKER widget.
<a href="#">WrapMode</a>	Wrap mode to be used.

#### Additional information

Affects only the animated mode.

### 7.2.33.5.1.39 TICKER\_Start()

#### Description

Starts the TICKER.

#### Prototype

```
void TICKER_Start(TICKER_Handle hObj);
```

#### Parameters

Parameter	Description
<a href="#">hObj</a>	Handle of TICKER widget.

### 7.2.33.5.1.40 TICKER\_Stop()

#### Description

Stops the TICKER.

#### Prototype

```
void TICKER_Stop(TICKER_Handle hObj);
```

#### Parameters

Parameter	Description
<a href="#">hObj</a>	Handle of TICKER widget.

#### 7.2.33.5.1.41 TICKER\_SetUserData()

##### Description

Prototype explained at the beginning of the chapter as `<WIDGET>_SetUserData()` on page 1166.



## 7.2.33.5.2 Defines

### 7.2.33.5.2.1 TICKER flags

#### Description

TICKER flags used by the TICKER widget. These flags are used to configure the TICKER Widget.

#### Definition

```
#define TICKER_CF_VCENTER      GUI_TA_VCENTER
#define TICKER_CF_TOP         GUI_TA_TOP
#define TICKER_CF_BOTTOM      GUI_TA_BOTTOM
#define TICKER_DIR_HORIZONTAL (0)
#define TICKER_DIR_VERTICAL  (1)
```

#### Symbols

Definition	Description
Vertical alignment	
<a href="#">TICKER_CF_TOP</a>	Align Y-position with top of font.
<a href="#">TICKER_CF_VCENTER</a>	Center Y-position of font.
<a href="#">TICKER_CF_BOTTOM</a>	Align Y-position with bottom pixel line of font.
Movement	
<a href="#">TICKER_DIR_HORIZONTAL</a>	Used to set horizontal motion in animated mode.
<a href="#">TICKER_DIR_VERTICAL</a>	Used to set vertical motion in animated mode.

### 7.2.34 TREEVIEW: Treeview widget

A TREEVIEW widget can be used to show a hierarchical view of information like files in a directory or items of an index, whereas each item can be a node or a leaf. Each node can have a number of sub items and can be closed or opened.

A node consists of a button image, which shows a plus sign in closed state or a minus sign in open state, two item images (one for closed and one for open state) and the item text. Pressing the button image or double clicking the item image toggles the state (open or closed) of the node.

A leaf consists of an item image and the item text. The current selection can be marked by highlighting the item text or by highlighting the whole row. All items of a tree are joined by lines per default.

**Note**

All TREEVIEW-related routines are located in the file(s) TREEVIEW\*.c, TREEVIEW\*.h. All identifiers are prefixed TREEVIEW.

The table below shows the appearances of the TREEVIEW widget:

Description	TREEVIEW widget
<p>TREEVIEW widget with row selection enabled.</p>	
<p>TREEVIEW widget with text selection enabled.</p>	
<p>TREEVIEW widget with some application defined bitmaps and lines off.</p>	

### 7.2.34.1 Description of terms

#### Item

This means a TREEVIEW item which can be a leaf or a node.

#### Leaf

A leaf is a TREEVIEW item which is not able to have any children. It is represented by the leaf bitmap and the item text.

#### Node

A node is a TREEVIEW item which is able to have children. It is represented by the button bitmap, the node bitmap and the item text. The state of the node can be toggled by pressing the button bitmap or by double clicking the node bitmap or the selected area of the item. In open state the children are visible below the node at the next level of indentation.

#### Button bitmap

This means the bitmap visible at nodes which can be pressed to toggle the state of the node.

#### Item bitmap

Left beside the item text the item bitmap is shown. Which bitmap is shown depends in the item (leaf or node) and in case of a node it also depends on the state, collapsed or expanded.

#### Expanded state

In expanded state the children of a node are visible and the minus sign is shown in the button bitmap.

#### Collapsed state





In collapsed state the children of a node are hidden and the plus sign is shown in the button bitmap.

#### Joining lines

Lines which are used to connect the items of a tree. The lines connect the button bitmaps of the nodes and the item bitmaps of the leafs according to the hierarchy of the tree.

### 7.2.34.2 Configuration options

Type	Macro	Default	Description
S	TREEVIEW_FONT_DEFAULT	&GUI_Font13_1	Default font used to draw the text.
N	TREEVIEW_BKCOLOR0_DEFAULT	GUI_WHITE	Background color for unselected state.
N	TREEVIEW_BKCOLOR1_DEFAULT	GUI_BLUE	Background color for selected state.
N	TREEVIEW_BKCOLOR2_DEFAULT	0xC0C0C0	Background color for disabled state.
N	TREEVIEW_TEXTCOLOR0_DEFAULT	GUI_BLACK	Text color for unselected state.
N	TREEVIEW_TEXTCOLOR1_DEFAULT	GUI_WHITE	Text color for selected state.
N	TREEVIEW_TEXTCOLOR2_DEFAULT	GUI_GRAY	Text color for disabled state.

Type	Macro	Default	Description
N	TREEVIEW_LINECOLOR0_DEFAULT	GUI_BLACK	Line color for unselected state.
N	TREEVIEW_LINECOLOR1_DEFAULT	GUI_WHITE	Line color for selected state.
N	TREEVIEW_LINECOLOR2_DEFAULT	GUI_GRAY	Line color for disabled state.
S	TREEVIEW_IMAGE_CLOSED_DEFAULT		Item image for node in closed state.
S	TREEVIEW_IMAGE_OPEN_DEFAULT		Item image for node in open state.
S	TREEVIEW_IMAGE_LEAF_DEFAULT		Item image for leaf.
S	TREEVIEW_IMAGE_PLUS_DEFAULT		Plus sign.
S	TREEVIEW_IMAGE_MINUS_DEFAULT		Minus sign.
N	TREEVIEW_INDENT_DEFAULT	16	Number of pixels for indenting.
N	TREEVIEW_TEXT_INDENT_DEFAULT	20	Number of pixels for indenting text.

### 7.2.34.3 Predefined IDs

The following symbols define IDs which may be used to make TREEVIEW widgets distinguishable from creation.

```
#define GUI_ID_TREEVIEW0    0x240
#define GUI_ID_TREEVIEW1    0x241
#define GUI_ID_TREEVIEW2    0x242
#define GUI_ID_TREEVIEW3    0x243
#define GUI_ID_TREEVIEW4    0x244
#define GUI_ID_TREEVIEW5    0x245
#define GUI_ID_TREEVIEW6    0x246
#define GUI_ID_TREEVIEW7    0x247
#define GUI_ID_TREEVIEW8    0x248
#define GUI_ID_TREEVIEW9    0x249
```

### 7.2.34.4 Notification codes

The following events are sent from a treeview widget to its parent window as part of a WM\_NOTIFY\_PARENT message:

Message	Description
WM_NOTIFICATION_CLICKED	TREEVIEW has been clicked.
WM_NOTIFICATION_RELEASED	TREEVIEW has been released.
WM_NOTIFICATION_MOVED_OUT	TREEVIEW has been clicked and pointer has been moved out of the widget area without releasing.
WM_NOTIFICATION_SEL_CHANGED	Value (selection) of the TREEVIEW widget has changed.

### 7.2.34.5 Keyboard reaction

The widget reacts to the following keys if it has the input focus:

Key	Reaction
GUI_KEY_RIGHT	If the cursor is at a closed node, the node is opened. If the cursor is at an open node the cursor moves to the first child of the node.
GUI_KEY_DOWN	The cursor moves to the next visible item below the current position.
GUI_KEY_LEFT	If the cursor is at a leaf the cursor moves to the parent node of the item. If the cursor is at an open node, the node will be closed. If the cursor is at a closed node, the cursor moves to the next parent node.
GUI_KEY_UP	The cursor moves to the previous visible item above the current position.

### 7.2.34.6 TREEVIEW API

The table below lists the available TREEVIEW-related routines of emWin in alphabetical order. Detailed descriptions of the routines follow.

#### Functions

Routine	Description
Common routines	
<code>TREEVIEW_AttachItem()</code>	Attaches an already existing item to the TREEVIEW widget.
<code>TREEVIEW_CreateEx()</code>	Creates a TREEVIEW widget.
<code>TREEVIEW_CreateIndirect()</code>	Creates a TREEVIEW widget from a resource table.
<code>TREEVIEW_CreateUser()</code>	Creates a TREEVIEW widget using extra bytes as user data.
<code>TREEVIEW_DecSel()</code>	Moves the cursor to the previous visible item.
<code>TREEVIEW_GetDefaultBkColor()</code>	Returns the default background color.
<code>TREEVIEW_GetDefaultFont()</code>	Returns the default font used to draw the item text.
<code>TREEVIEW_GetDefaultLineColor()</code>	Returns the default line color.
<code>TREEVIEW_GetDefaultTextColor()</code>	Returns the default text color.
<code>TREEVIEW_GetItem()</code>	Returns the requested item.
<code>TREEVIEW_GetSel()</code>	Returns the currently selected item.
<code>TREEVIEW_GetUserData()</code>	Retrieves the data set with <code>TREEVIEW_SetUserData()</code> .
<code>TREEVIEW_IncSel()</code>	Moves the cursor to the next visible item of the given TREEVIEW widget.
<code>TREEVIEW_InsertItem()</code>	The function creates and inserts one new TREEVIEW item relative to the given item.
<code>TREEVIEW_ScrollToSel()</code>	Scrolls the given TREEVIEW widget to show the current selection.
<code>TREEVIEW_SetAutoScrollH()</code>	Enables or disables the use of an automatic horizontal scroll bar.

Routine	Description
<code>TREEVIEW_SetAutoScrollV()</code>	Enables or disables the use of an automatic vertical scroll bar.
<code>TREEVIEW_SetBitmapOffset()</code>	Sets the offset of the plus/minus bitmap.
<code>TREEVIEW_SetBkColor()</code>	Sets the background color.
<code>TREEVIEW_SetDefaultBkColor()</code>	Sets the default background color used for new TREEVIEW widgets.
<code>TREEVIEW_SetDefaultFont()</code>	Sets the default font used for new TREEVIEW widgets.
<code>TREEVIEW_SetDefaultLineColor()</code>	Sets the default line color used for new TREEVIEW widgets.
<code>TREEVIEW_SetDefaultTextColor()</code>	Sets the default text color used for new TREEVIEW widgets.
<code>TREEVIEW_SetFont()</code>	Sets the font to be used to draw the item text of the given TREEVIEW widget.
<code>TREEVIEW_SetHasLines()</code>	Manages the visibility of the joining lines between the TREEVIEW items.
<code>TREEVIEW_SetImage()</code>	Sets the images used to draw the TREEVIEW items.
<code>TREEVIEW_SetIndent()</code>	Sets the indentation of TREEVIEW items in pixels.
<code>TREEVIEW_SetLineColor()</code>	Sets the color used to draw the joining lines between the TREEVIEW items.
<code>TREEVIEW_SetOwnerDraw()</code>	Enables the TREEVIEW to be owner drawn.
<code>TREEVIEW_SetSel()</code>	Sets the currently selected item of the TREEVIEW widget.
<code>TREEVIEW_SetSelMode()</code>	Sets the selection mode of the TREEVIEW widget.
<code>TREEVIEW_SetTextColor()</code>	Sets the color used to draw the TREEVIEW items of the given TREEVIEW widget.
<code>TREEVIEW_SetTextIndent()</code>	Sets the indentation of item text in pixels.
<code>TREEVIEW_SetUserData()</code>	Sets the extra data of a TREEVIEW widget.
<b>Item related routines</b>	
<code>TREEVIEW_ITEM_Collapse()</code>	Collapses the given node.
<code>TREEVIEW_ITEM_CollapseAll()</code>	Collapses the given node and all subnodes.
<code>TREEVIEW_ITEM_Create()</code>	Creates a new TREEVIEW item.
<code>TREEVIEW_ITEM_Delete()</code>	Deletes the given TREEVIEW item.
<code>TREEVIEW_ITEM_Detach()</code>	Detaches the given item without deleting it.
<code>TREEVIEW_ITEM_Expand()</code>	Expands the given node.
<code>TREEVIEW_ITEM_ExpandAll()</code>	Expands the given node and all subnodes.
<code>TREEVIEW_ITEM_GetInfo()</code>	Returns an information structure of the given item.
<code>TREEVIEW_ITEM_GetText()</code>	Returns the item text.
<code>TREEVIEW_ITEM_GetUserData()</code>	Returns the <code>UserData</code> value of the treeview item.
<code>TREEVIEW_ITEM_SetImage()</code>	The function sets images to be used only with the given TREEVIEW item.
<code>TREEVIEW_ITEM_SetText()</code>	The function sets the text of the given item.
<code>TREEVIEW_ITEM_SetUserData()</code>	Sets the <code>UserData</code> value of the TREEVIEW item.

## Data structures

Structure	Description
<code>TREEVIEW_ITEM_INFO</code>	Structure that contains information about a node in a TREEVIEW widget.

## Defines

Group of defines	Description
<code>TREEVIEW bitmap indexes</code>	Bitmap indexes used by the TREEVIEW widget.
<code>TREEVIEW color indexes</code>	Color indexes used by the TREEVIEW widget.
<code>TREEVIEW create flags</code>	Create flags used by the TREEVIEW widget.
<code>TREEVIEW item flags</code>	Define the item type of a newly created TREEVIEW item.
<code>TREEVIEW position flags (get)</code>	Specify the position when retrieving a TREEVIEW item.
<code>TREEVIEW position flags (insert)</code>	Specify the position when creating a new TREEVIEW item.
<code>TREEVIEW selection modes</code>	Define the selection mode of a TREEVIEW widget.

## 7.2.34.6.1 Common routines

### 7.2.34.6.1.1 TREEVIEW\_AttachItem()

#### Description

Attaches an already existing item to the TREEVIEW widget.

#### Prototype

```
int TREEVIEW_AttachItem(TREEVIEW_Handle      hObj,
                       TREEVIEW_ITEM_Handle hItem,
                       TREEVIEW_ITEM_Handle hItemAt,
                       int                   Position);
```

#### Parameters

Parameter	Description
<code>hObj</code>	Handle of TREEVIEW widget.
<code>hItem</code>	Handle of item to be attached.
<code>hItemAt</code>	Handle of a currently attached item which specifies the position to be used.
<code>Position</code>	See <i>TREEVIEW position flags (insert)</i> on page 2613 for a full list of permitted values.

#### Return value

0        on success  
1        on error.

#### Additional information

The function can be used for attaching a single item as well as for attaching a complete tree. Note that in case of attaching a tree, the root item of the tree needs to be passed as `hItem`. If attaching the first item to an empty treeview the parameters `hItem` and `Position` should be 0.



### 7.2.34.6.1.2 TREEVIEW\_CreateEx()

#### Description

Creates a TREEVIEW widget of a specified size at a specified location.

#### Prototype

```
TREEVIEW_Handle TREEVIEW_CreateEx(int    x0,
                                   int    y0,
                                   int    xSize,
                                   int    ySize,
                                   WM_HWIN hParent,
                                   int    WinFlags,
                                   int    ExFlags,
                                   int    Id);
```

#### Parameters

Parameter	Description
<code>x0</code>	Leftmost pixel of the widget (in parent coordinates).
<code>y0</code>	Topmost pixel of the widget (in parent coordinates).
<code>xSize</code>	Horizontal size of the widget (in pixels).
<code>ySize</code>	Vertical size of the widget (in pixels).
<code>hParent</code>	Handle of parent window. If 0, the new TEXT widget will be a child of the desktop (top-level window).
<code>WinFlags</code>	Window create flags. Typically <code>WM_CF_SHOW</code> in order to make the widget visible immediately (refer to <i>Window create flags</i> on page 1146 for a list of available parameter values).
<code>ExFlags</code>	See <i>TREEVIEW create flags</i> on page 2610.
<code>Id</code>	Window ID of the widget.

#### Return value

Handle of the created widget. 0, if the function fails.

#### Additional information

The values of parameter `ExFlags` can be OR-combined.

### 7.2.34.6.1.3 TREEVIEW\_CreateIndirect()

#### Description

The prototype of this function is explained at the beginning of this chapter. Details can be found in the description of the function `<WIDGET>_CreateIndirect()` on page 1161. The element `Para` of the according `GUI_WIDGET_CREATE_INFO` structure is not used. The element `Flags` is used according to the parameter `ExFlags` of the function `TREEVIEW_CreateEx()`.

#### 7.2.34.6.1.4 TREEVIEW\_CreateUser()

##### Description

Prototype explained at the beginning of the chapter as `<WIDGET>_CreateUser()` on page 1162. For a detailed description of the parameters the function `TREEVIEW_CreateEx()` can be referred to.

### 7.2.34.6.1.5 TREEVIEW\_DecSel()

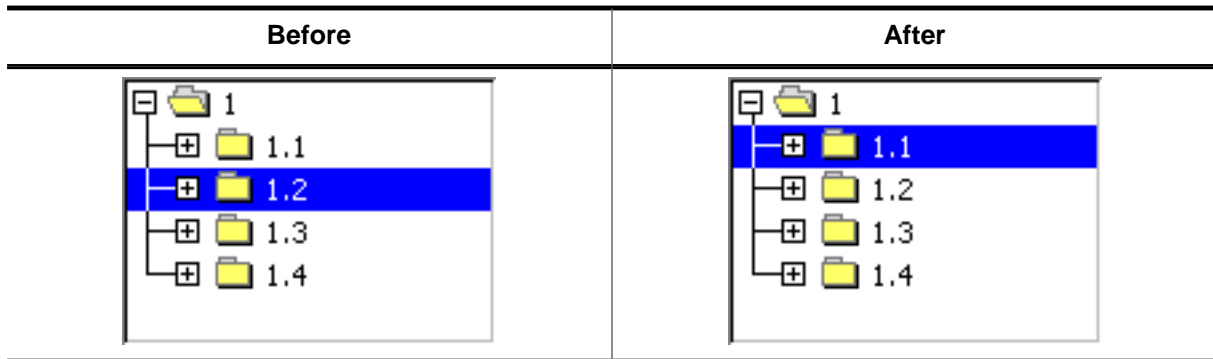

#### Description

Moves the cursor to the previous visible item of the given TREEVIEW widget.

#### Prototype

```
void TREEVIEW_DecSel(TREEVIEW_Handle hObj);
```

#### Parameters

Parameter	Description
<code>hObj</code>	Handle of TREEVIEW widget.

#### Additional information

If there is no previous visible item the cursor remains on the current position.

### 7.2.34.6.1.6 TREEVIEW\_GetDefaultBkColor()

#### Description

Returns the default background color used for new TREEVIEW widgets.

#### Prototype

```
GUI_COLOR TREEVIEW_GetDefaultBkColor(int Index);
```

#### Parameters

Parameter	Description
<a href="#">Index</a>	See <i>TREEVIEW color indexes</i> on page 2609 for a full list of permitted values.

#### Return value

Default background color used for new TREEVIEW widgets.

### 7.2.34.6.1.7 TREEVIEW\_GetDefaultFont()

#### Description

Returns the default font used to draw the item text of new TREEVIEW widgets.

#### Prototype

```
GUI_FONT *TREEVIEW_GetDefaultFont(void);
```

#### Return value

Default font used to draw the item text of new TREEVIEW widgets.

### 7.2.34.6.1.8 TREEVIEW\_GetDefaultLineColor()

#### Description

Returns the default color used to draw the joining lines of new TREEVIEW widgets.

#### Prototype

```
GUI_COLOR TREEVIEW_GetDefaultLineColor(int Index);
```

#### Parameters

Parameter	Description
<a href="#">Index</a>	See <i>TREEVIEW color indexes</i> on page 2609 for a full list of permitted values.

#### Return value

Default color used to draw the joining lines of new treeview widgets.

### 7.2.34.6.1.9 TREEVIEW\_GetDefaultTextColor()

#### Description

Returns the default text color used to draw the item text of new TREEVIEW widgets.

#### Prototype

```
GUI_COLOR TREEVIEW_GetDefaultTextColor(int Index);
```

#### Parameters

Parameter	Description
<a href="#">Index</a>	See <i>TREEVIEW color indexes</i> on page 2609 for a full list of permitted values.

#### Return value

Default text color used to draw the item text of new TREEVIEW widgets.



### 7.2.34.6.1.10 TREEVIEW\_GetItem()

#### Description

Returns the handle of the requested treeview item.

#### Prototype

```
TREEVIEW_ITEM_Handle TREEVIEW_GetItem(TREEVIEW_Handle hObj,
                                       TREEVIEW_ITEM_Handle hItem,
                                       int Flags);
```

#### Parameters

Parameter	Description
<code>hObj</code>	Handle of TREEVIEW widget.
<code>hItem</code>	Handle of TREEVIEW item specifying the position to start search from.
<code>Flags</code>	See <i>TREEVIEW position flags (get)</i> on page 2612 for a full list of permitted values.

#### Return value

Handle of the requested TREEVIEW item on success, otherwise 0.

#### Example

The picture shows a TREEVIEW widget with several items. The following shows how parameter `Flags` can be used for getting TREEVIEW items relative to parameter `hItem`:

- `TREEVIEW_GET_NEXT_SIBLING`  
The next sibling of 1.1 is 1.2.
- `TREEVIEW_GET_PREV_SIBLING`  
The previous sibling of 1.2 is 1.1.
- `TREEVIEW_GET_FIRST_CHILD`  
The first child item of 1.1.1 is 1.1.1.1.
- `TREEVIEW_GET_PARENT`  
The parent item of 1.1 is 1.

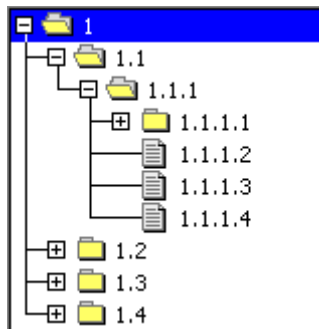

To get the first item when no item is known the `TREEVIEW_GET_FIRST` and `TREEVIEW_GET_LAST` flags are used. In this case `hItem` is 0. If the requested item does not exist, the function returns 0.

### 7.2.34.6.1.11 TREEVIEW\_GetSel()

#### Description

Returns the handle of the currently selected TREEVIEW item.

#### Prototype

```
TREEVIEW_ITEM_Handle TREEVIEW_GetSel(TREEVIEW_Handle hObj);
```

#### Parameters

Parameter	Description
<a href="#">hObj</a>	Handle of TREEVIEW widget.

#### Return value

Handle of the currently selected treeview item. If no item has been selected the return value is 0.

### 7.2.34.6.1.12 TREEVIEW\_GetUserData()

#### Description

Prototype explained at the beginning of the chapter as `<WIDGET>_GetUserData()` on page 1165.

### 7.2.34.6.1.13 TREEVIEW\_IncSel()

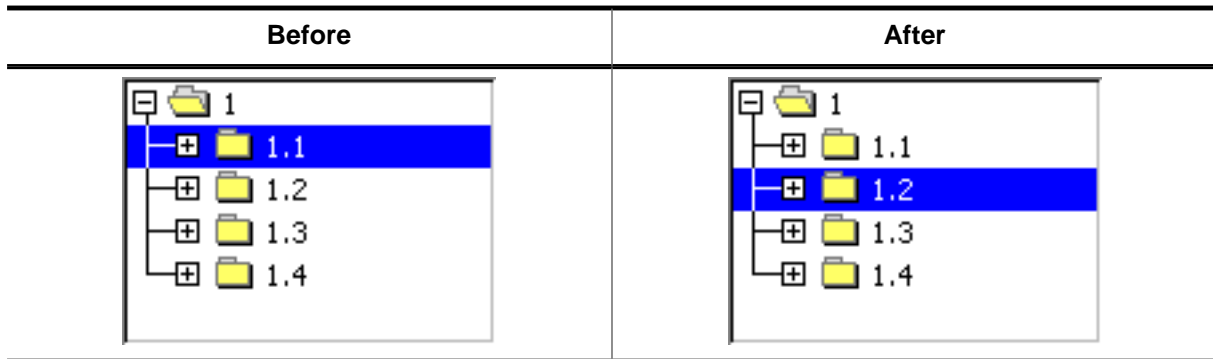

#### Description

Moves the cursor to the next visible item of the given TREEVIEW widget.

#### Prototype

```
void TREEVIEW_IncSel(TREEVIEW_Handle hObj);
```

#### Parameters

Parameter	Description
hObj	Handle of TREEVIEW widget.

#### Additional information

If there is no next visible item the cursor remains on the current position.

### 7.2.34.6.1.14 TREEVIEW\_InsertItem()



#### Description

The function creates and inserts one new TREEVIEW item relative to the given item.

#### Prototype

```
TREEVIEW_ITEM_Handle TREEVIEW_InsertItem(
    TREEVIEW_Handle      hObj,
    int                  IsNode,
    TREEVIEW_ITEM_Handle hItemPrev,
    int                  Position,
    const char           * s);
```

#### Parameters

Parameter	Description
<code>hObj</code>	Handle of TREEVIEW widget.
<code>IsNode</code>	See <i>TREEVIEW item flags</i> on page 2611 for a full list of permitted values.
<code>hItemPrev</code>	Handle of TREEVIEW item specifying the position of the new item.
<code>Position</code>	See <i>TREEVIEW position flags (insert)</i> on page 2613 for a full list of permitted values.
<code>s</code>	Text of new TREEVIEW item.

#### Return value

Handle of the new item on success, otherwise 0.

### 7.2.34.6.1.15 TREEVIEW\_ScrollToSel()

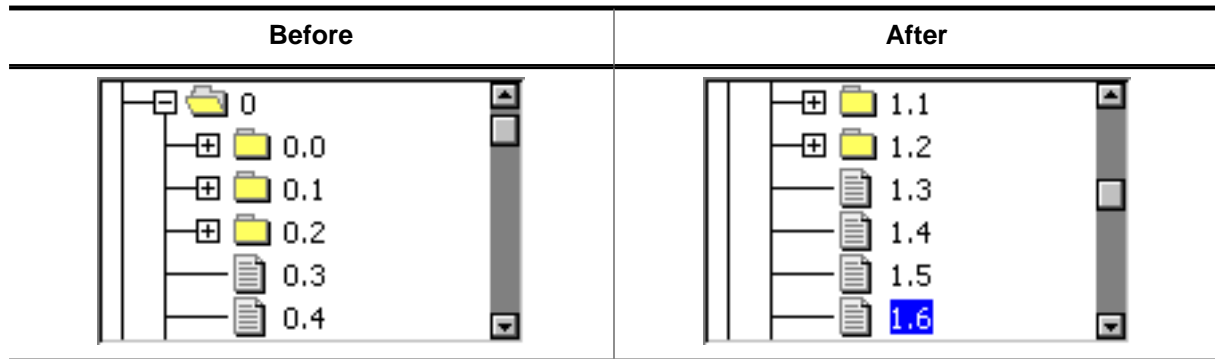

#### Description

Scrolls the given TREEVIEW widget to show the current selection.

#### Prototype

```
void TREEVIEW_ScrollToSel(TREEVIEW_Handle hObj);
```

#### Parameters

Parameter	Description
<code>hObj</code>	Handle of TREEVIEW widget.

### 7.2.34.6.1.16 TREEVIEW\_SetAutoScrollH()

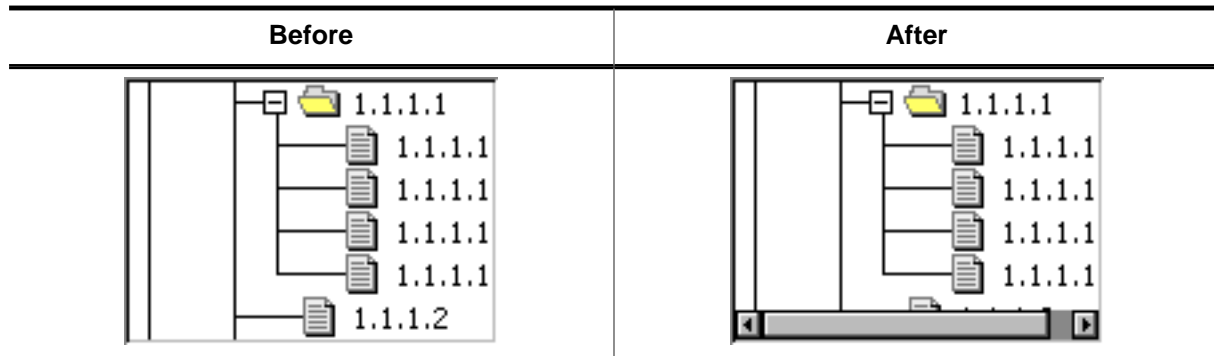

#### Description

Enables or disables the use of an automatic horizontal scroll bar.

#### Prototype

```
void TREEVIEW_SetAutoScrollH(TREEVIEW_Handle hObj,
                             int State);
```

#### Parameters

Parameter	Description
<code>hObj</code>	Handle of TREEVIEW widget.
<code>State</code>	1 for enabling an automatic horizontal scroll bar, 0 for disabling.

### 7.2.34.6.1.17 TREEVIEW\_SetAutoScrollV()

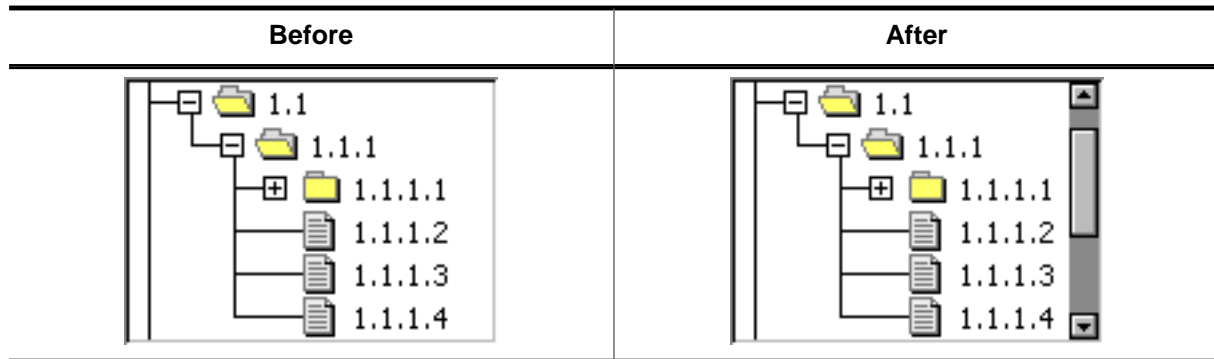

#### Description

Enables or disables the use of an automatic vertical scroll bar.

#### Prototype

```
void TREEVIEW_SetAutoScrollV(TREEVIEW_Handle hObj,
                             int State);
```

#### Parameters

Parameter	Description
<code>hObj</code>	Handle of TREEVIEW widget.
<code>State</code>	1 for enabling an automatic vertical scroll bar, 0 for disabling.



### 7.2.34.6.1.18 TREEVIEW\_SetBitmapOffset()

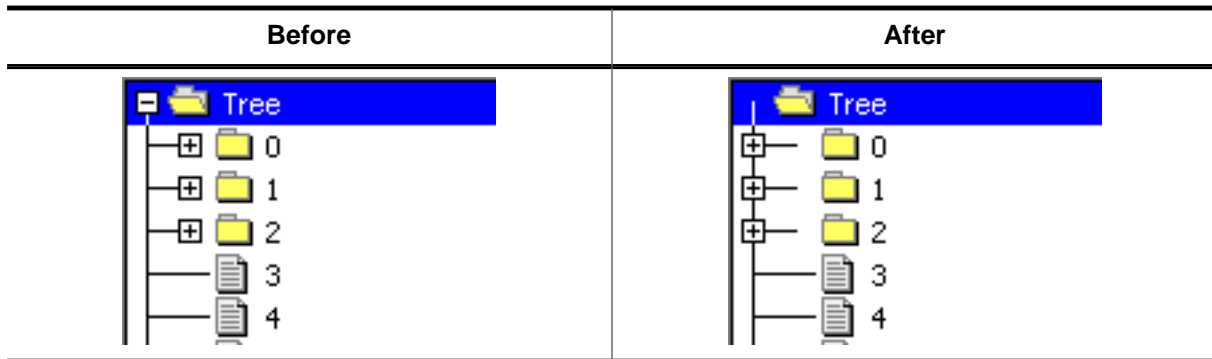

#### Description

Sets the offset of the plus/minus bitmap.

#### Prototype

```
void TREEVIEW_SetBitmapOffset(TREEVIEW_Handle hObj,
                              int Index,
                              int xOff,
                              int yOff);
```

#### Parameters

Parameter	Description
<code>hObj</code>	Handle of TREEVIEW widget.
<code>Index</code>	Currently the only permitted value for this parameter is <code>TREEVIEW_BI_PM</code> .
<code>xOff</code>	Horizontal offset.
<code>yOff</code>	Vertical offset.

#### Additional information

If `xOff` and `yOff` are set to 0 (default), the plus/minus bitmap is centered horizontally and vertically in the indentation space left of the actual item. The indentation space is related to the parent item (if exists) or to the left border of the widget. See “before / after” screenshots of the function `TREEVIEW_SetIndent()`.

### 7.2.34.6.1.19 TREEVIEW\_SetBkColor()

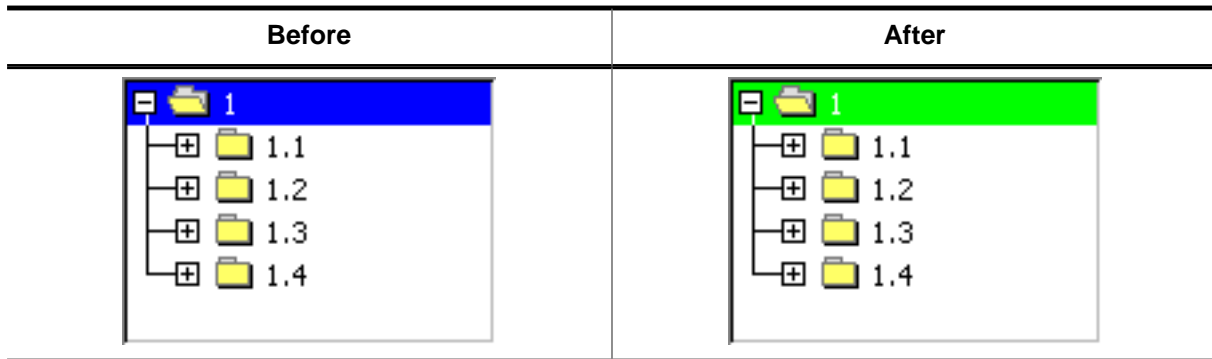

#### Description

Sets the background color of the given TREEVIEW widget.

#### Prototype

```
void TREEVIEW_SetBkColor(TREEVIEW_Handle hObj,
                        int Index,
                        GUI_COLOR Color);
```

#### Parameters

Parameter	Description
<code>hObj</code>	Handle of TREEVIEW widget.
<code>Index</code>	See <i>TREEVIEW color indexes</i> on page 2609 for a full list of permitted values.
<code>Color</code>	<code>Color</code> to be used.

### 7.2.34.6.1.20 TREEVIEW\_SetDefaultBkColor()

#### Description

Sets the default background color used for new TREEVIEW widgets.

#### Prototype

```
void TREEVIEW_SetDefaultBkColor(int Index,  
                                GUI_COLOR Color);
```

#### Parameters

Parameter	Description
<a href="#">Index</a>	See <i>TREEVIEW color indexes</i> on page 2609 for a full list of permitted values.
<a href="#">Color</a>	<a href="#">Color</a> to be used.

### 7.2.34.6.1.21 TREEVIEW\_SetDefaultFont()

#### Description

Sets the default font used for new TREEVIEW widgets.

#### Prototype

```
void TREEVIEW_SetDefaultFont(const GUI_FONT * pFont);
```

#### Parameters

Parameter	Description
<code>pFont</code>	Pointer to GUI_FONT structure to be used.

### 7.2.34.6.1.22 TREEVIEW\_SetDefaultLineColor()

#### Description

Sets the default line color used for new TREEVIEW widgets.

#### Prototype

```
void TREEVIEW_SetDefaultLineColor(int Index,  
GUI_COLOR Color);
```

#### Parameters

Parameter	Description
<code>Index</code>	See <i>TREEVIEW color indexes</i> on page 2609 for a full list of permitted values.
<code>Color</code>	<code>Color</code> to be used.

### 7.2.34.6.1.23 TREEVIEW\_SetDefaultTextColor()

#### Description

Sets the default text color used for new TREEVIEW widgets.

#### Prototype

```
void TREEVIEW_SetDefaultTextColor(int Index,  
GUI_COLOR Color);
```

#### Parameters

Parameter	Description
<a href="#">Index</a>	See <i>TREEVIEW color indexes</i> on page 2609 for a full list of permitted values.
<a href="#">Color</a>	<a href="#">Color</a> to be used.

### 7.2.34.6.1.24 TREEVIEW\_SetFont()

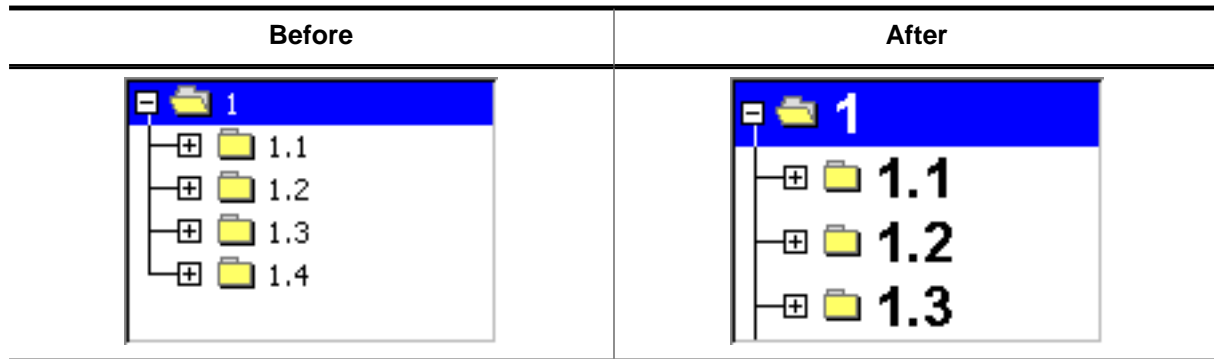

#### Description

Sets the font to be used to draw the item text of the given TREEVIEW widget.

#### Prototype

```
void TREEVIEW_SetFont(    TREEVIEW_Handle  hObj,
                        const GUI_FONT    * pFont);
```

#### Parameters

Parameter	Description
<code>hObj</code>	Handle of TREEVIEW widget.
<code>pFont</code>	Pointer to GUI_FONT structure to be used.

### 7.2.34.6.1.25 TREEVIEW\_SetHasLines()

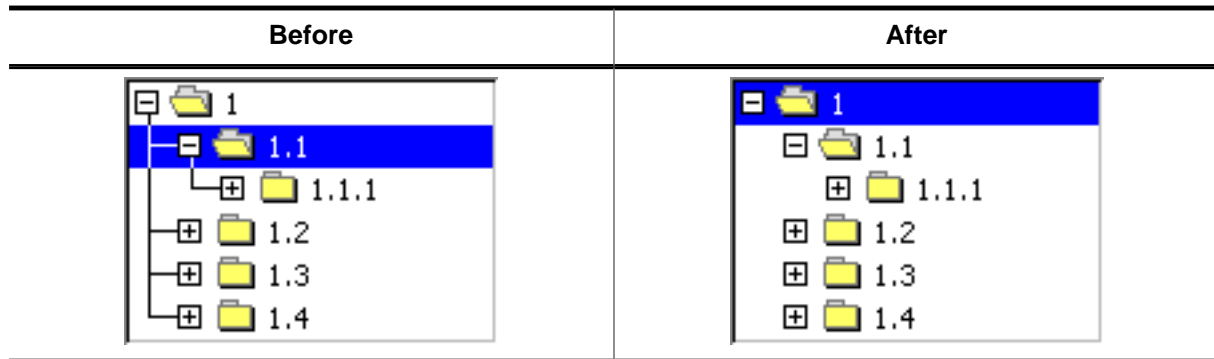

#### Description

Manages the visibility of the joining lines between the TREEVIEW items.

#### Prototype

```
void TREEVIEW_SetHasLines(TREEVIEW_Handle hObj,
                          int State);
```

#### Parameters

Parameter	Description
<code>hObj</code>	Handle of TREEVIEW widget.
<code>State</code>	1 for showing the lines, 0 for not showing the lines.

#### Additional information

Per default the lines are shown.



### 7.2.34.6.1.26 TREEVIEW\_SetImage()

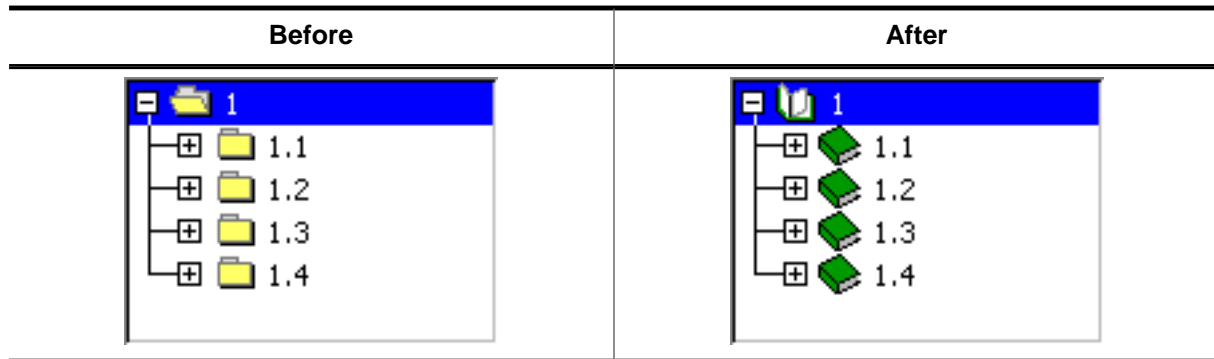

#### Description

Sets the images used to draw the TREEVIEW items.

#### Prototype

```
void TREEVIEW_SetImage(    TREEVIEW_Handle  hObj,
                          int                Index,
                          const GUI_BITMAP  * pBitmap);
```

#### Parameters

Parameter	Description
<a href="#">hObj</a>	Handle of TREEVIEW widget.
<a href="#">Index</a>	See <i>TREEVIEW bitmap indexes</i> on page 2608 for a full list of permitted values.
<a href="#">pBitmap</a>	Pointer to bitmap structure to be used.

### 7.2.34.6.1.27 TREEVIEW\_SetIndent()

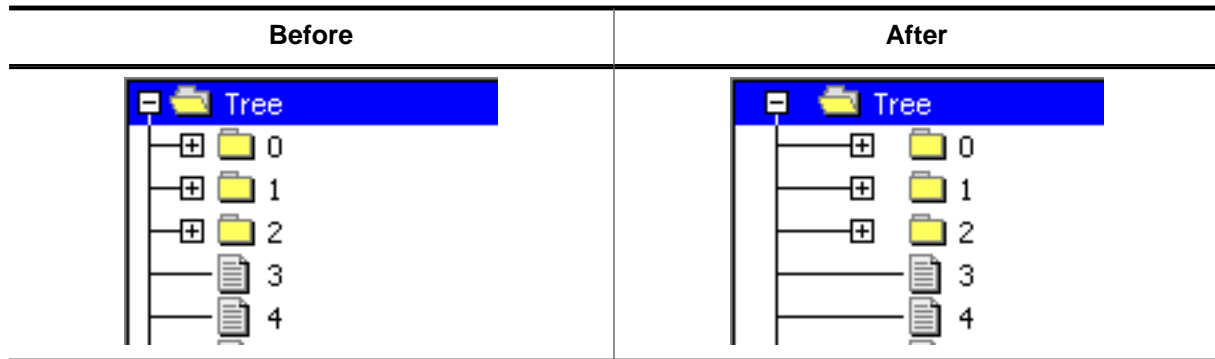

#### Description

Sets the indentation of TREEVIEW items in pixels. Indentation is 16 pixels by default.

#### Prototype

```
int TREEVIEW_SetIndent(TREEVIEW_Handle hObj,
                      int Indent);
```

#### Parameters

Parameter	Description
<code>hObj</code>	Handle of TREEVIEW widget.
<code>Indent</code>	Distance (in pixels) to indent treeview items.

#### Return value

Previous indentation.

### 7.2.34.6.1.28 TREEVIEW\_SetLineColor()

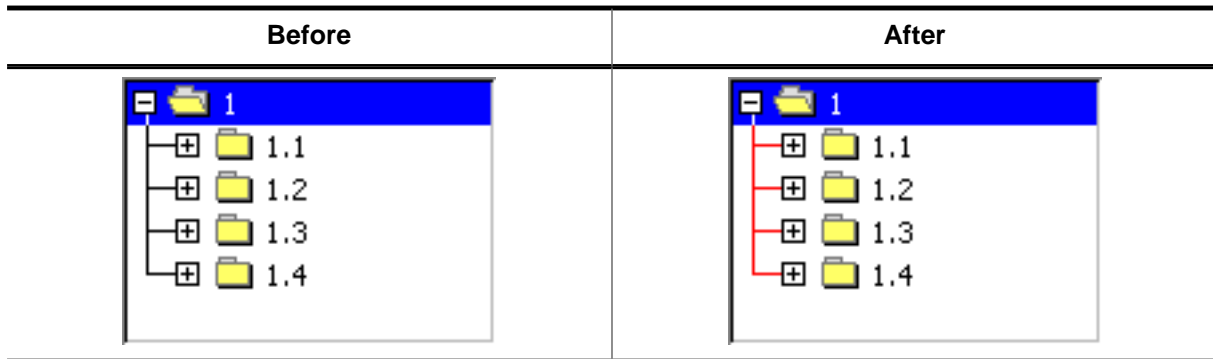

#### Description

Sets the color used to draw the joining lines between the TREEVIEW items.

#### Prototype

```
void TREEVIEW_SetLineColor(TREEVIEW_Handle hObj,
                           int             Index,
                           GUI_COLOR      Color);
```

#### Parameters

Parameter	Description
<code>hObj</code>	Handle of TREEVIEW widget.
<code>Index</code>	See <i>TREEVIEW color indexes</i> on page 2609 for a full list of permitted values.
<code>Color</code>	<code>Color</code> to be used.

### 7.2.34.6.1.29 TREEVIEW\_SetOwnerDraw()

#### Description

Enables the TREEVIEW to be owner drawn.

#### Prototype

```
void TREEVIEW_SetOwnerDraw(TREEVIEW_Handle hObj,  
                           WIDGET_DRAW_ITEM_FUNC * pfDrawItem);
```

#### Parameters

Parameter	Description
<code>hObj</code>	Handle of TREEVIEW widget.
<code>pfDrawItem</code>	Pointer to the owner draw function. See <i>User drawn widgets</i> on page 1175.

#### Supported commands

- WIDGET\_ITEM\_GET\_XSIZE
- WIDGET\_ITEM\_GET\_YSIZE
- WIDGET\_ITEM\_DRAW\_BACKGROUND
- WIDGET\_ITEM\_DRAW\_BITMAP
- WIDGET\_ITEM\_DRAW\_TEXT
- WIDGET\_ITEM\_DRAW\_TICKS

### 7.2.34.6.1.30 TREEVIEW\_SetSel()

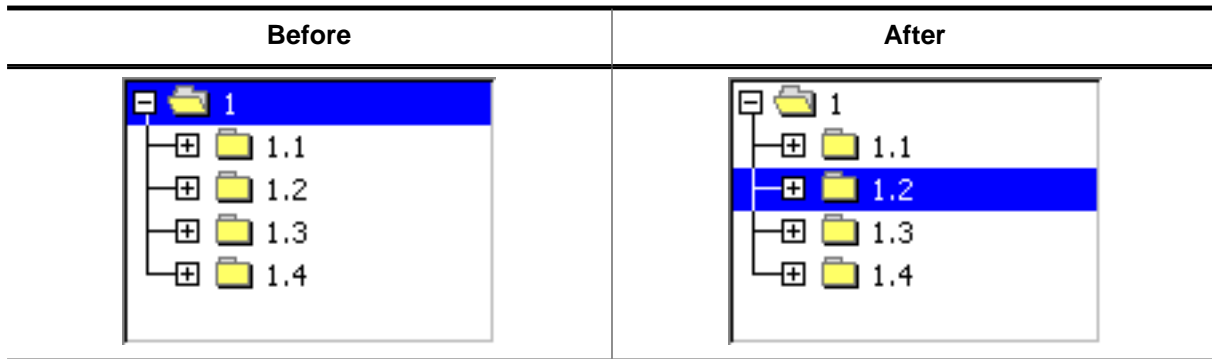

#### Description

Sets the currently selected item of the TREEVIEW widget.

#### Prototype

```
void TREEVIEW_SetSel(TREEVIEW_Handle hObj,
                    TREEVIEW_ITEM_Handle hItem);
```

#### Parameters

Parameter	Description
<code>hObj</code>	Handle of TREEVIEW widget.
<code>hItem</code>	Handle of treeview item to be selected.

#### Additional information

If the given TREEVIEW item is a child of a closed node no selection is visible after calling this function.

### 7.2.34.6.1.31 TREEVIEW\_SetSelMode()

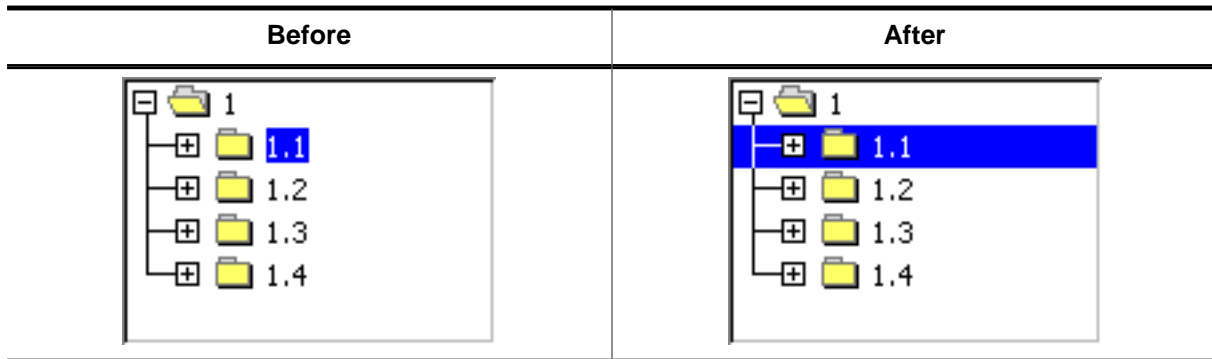

#### Description

Sets the selection mode of the TREEVIEW widget.

#### Prototype

```
void TREEVIEW_SetSelMode(TREEVIEW_Handle hObj,
                        int Mode);
```

#### Parameters

Parameter	Description
<code>hObj</code>	Handle of TREEVIEW widget.
<code>Mode</code>	See <i>TREEVIEW selection modes</i> on page 2614.

#### Additional information

Default selection mode is text selection. If row selection is activated, the complete row can be used to select the item. If text selection is active, only the item text and the item bitmap can be used for selection.

### 7.2.34.6.1.32 TREEVIEW\_SetTextColor()

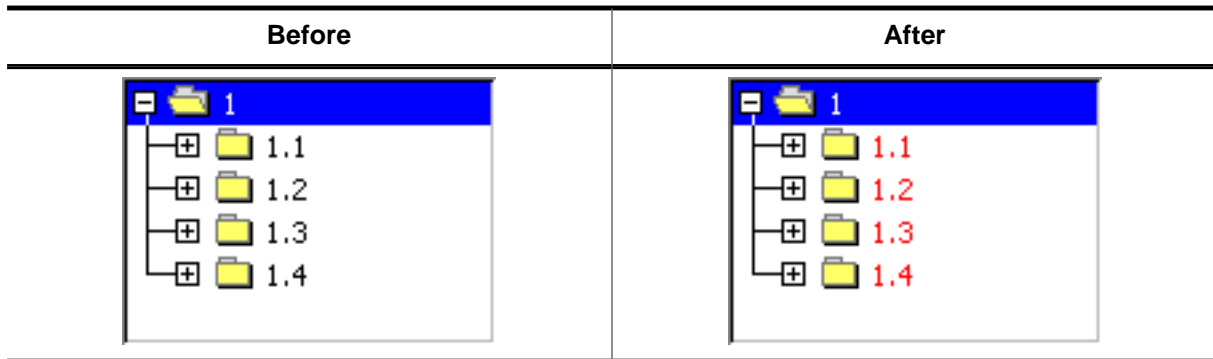

#### Description

Sets the color used to draw the TREEVIEW items of the given TREEVIEW widget.

#### Prototype

```
void TREEVIEW_SetTextColor(TREEVIEW_Handle hObj,
                           int             Index,
                           GUI_COLOR      Color);
```

#### Parameters

Parameter	Description
<code>hObj</code>	Handle of TREEVIEW widget.
<code>Index</code>	See <i>TREEVIEW color indexes</i> on page 2609 for a full list of permitted values.
<code>Color</code>	<code>Color</code> to be used.

### 7.2.34.6.1.33 TREEVIEW\_SetTextIndent()

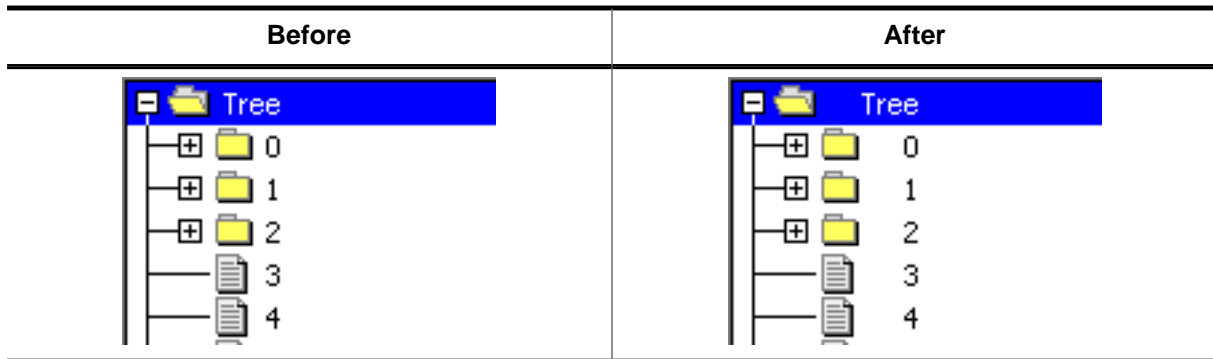

#### Description

Sets the indentation of item text in pixels. Text indentation is 20 pixels by default.

#### Prototype

```
int TREEVIEW_SetTextIndent(TREEVIEW_Handle hObj,
                           int TextIndent);
```

#### Parameters

Parameter	Description
<code>hObj</code>	Handle of TREEVIEW widget.
<code>TextIndent</code>	Text indentation to be used.

#### Return value

Previous text indentation.



#### 7.2.34.6.1.34 TREEVIEW\_SetUserData()

##### Description

Prototype explained at the beginning of the chapter as `<WIDGET>_SetUserData()` on page 1166.

## 7.2.34.6.2 Item related routines

### 7.2.34.6.2.1 TREEVIEW\_ITEM\_Collapse()

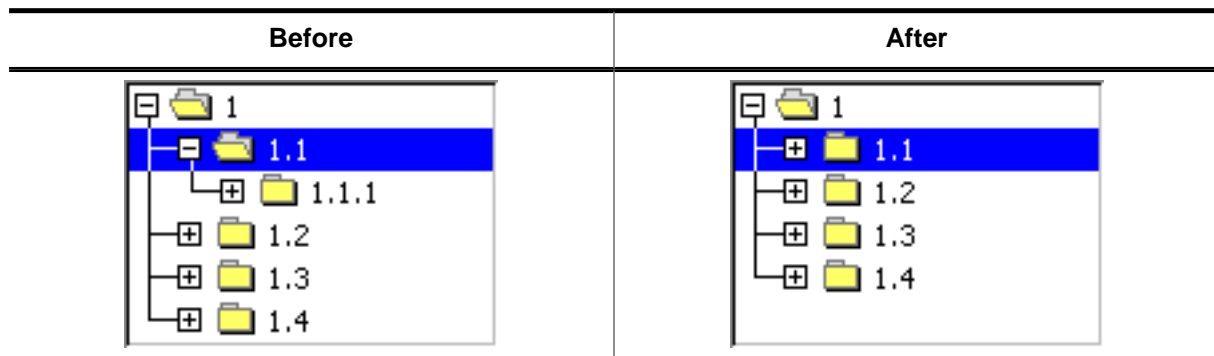

#### Description

Collapses the given node and shows the plus sign afterwards.

#### Prototype

```
void TREEVIEW_ITEM_Collapse(TREEVIEW_ITEM_Handle hItem);
```

#### Parameters

Parameter	Description
<code>hItem</code>	Handle of the item to be collapsed.

#### Additional information

The given item needs to be a node. Otherwise the function returns immediately.

### 7.2.34.6.2.2 TREEVIEW\_ITEM\_CollapseAll()

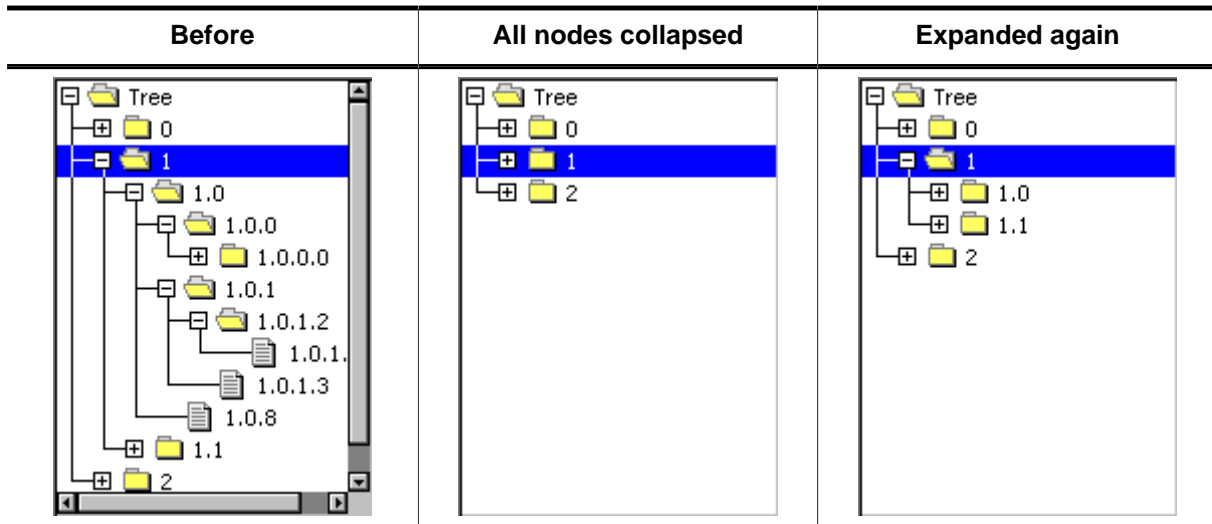

#### Description

Collapses the given node and all subnodes and shows the plus sign afterwards.

#### Prototype

```
void TREEVIEW_ITEM_CollapseAll(TREEVIEW_ITEM_Handle hItem);
```

#### Parameters

Parameter	Description
<code>hItem</code>	Handle of the item to be collapsed.

#### Additional information

This function collapses all subnodes, so if the given node is expanded again, all subnodes are in collapsed state.

### 7.2.34.6.2.3 TREEVIEW\_ITEM\_Create()

#### Description

Creates a new TREEVIEW item.

#### Prototype

```
TREEVIEW_ITEM_Handle TREEVIEW_ITEM_Create(    int    IsNode,  
                                             const char * s,  
                                             U32    UserData);
```

#### Parameters

Parameter	Description
<a href="#">IsNode</a>	See <i>TREEVIEW item flags</i> on page 2611 for a full list of permitted values.
<a href="#">s</a>	Pointer to item text to be shown.
<a href="#">UserData</a>	32 bit value to be used by the application.

#### Return value

Handle of new item on success, otherwise 0.

#### Additional information

After creating a treeview item it contains a copy of the text.

#### 7.2.34.6.2.4 TREEVIEW\_ITEM\_Delete()

##### Description

Deletes the given TREEVIEW item.

##### Prototype

```
void TREEVIEW_ITEM_Delete(TREEVIEW_ITEM_Handle hItem);
```

##### Parameters

Parameter	Description
<code>hItem</code>	Handle of item to be deleted.

##### Additional information

If the item is currently not attached to any TREEVIEW, the parameter `hObj` should be 0. The function can be used to delete a single item as well as for deleting a complete tree. In case of deleting a tree the root element of the tree should be passed to the function.

### 7.2.34.6.2.5 TREEVIEW\_ITEM\_Detach()

#### Description

Detaches the given TREEVIEW item from the TREEVIEW widget.

#### Prototype

```
void TREEVIEW_ITEM_Detach(TREEVIEW_ITEM_Handle hItem);
```

#### Parameters

Parameter	Description
<code>hItem</code>	Handle of item to be detached.

#### Additional information

The function detaches the given item and all of its children from the TREEVIEW widget.

### 7.2.34.6.2.6 TREEVIEW\_ITEM\_Expand()

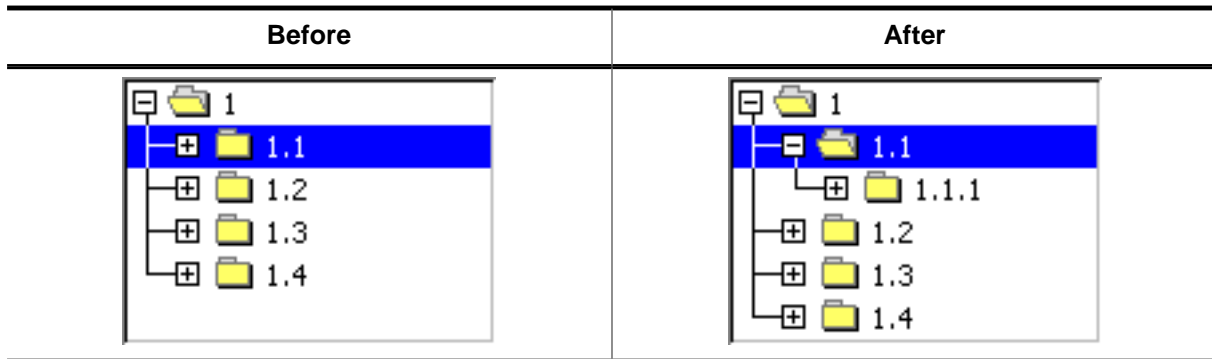

#### Description

Expands the given node and shows the minus sign afterwards.

#### Prototype

```
void TREEVIEW_ITEM_Expand(TREEVIEW_ITEM_Handle hItem);
```

#### Parameters

Parameter	Description
<code>hItem</code>	Handle of node to be expanded.

#### Additional information

The given item needs to be a node. Otherwise the function returns immediately.

### 7.2.34.6.2.7 TREEVIEW\_ITEM\_ExpandAll()

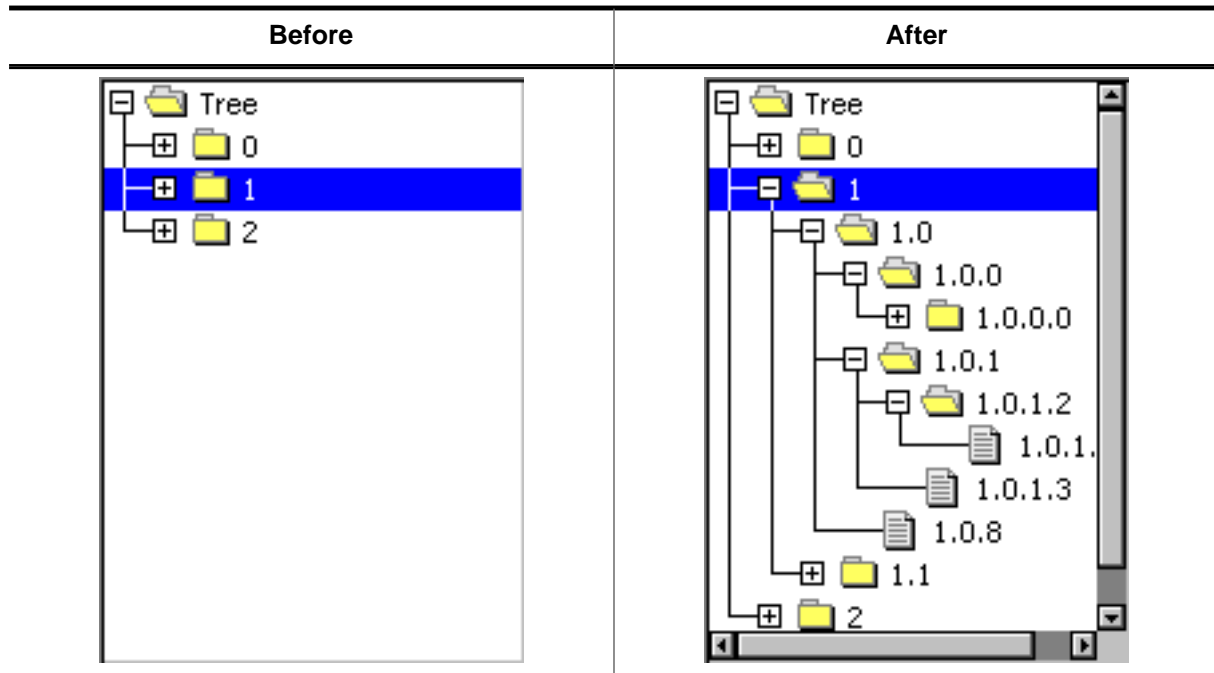

#### Description

Expands the given node and all subnodes and shows the minus sign afterwards.

#### Prototype

```
void TREEVIEW_ITEM_ExpandAll(TREEVIEW_ITEM_Handle hItem);
```

#### Parameters

Parameter	Description
<code>hItem</code>	Handle of node to be expanded.



### 7.2.34.6.2.8 TREEVIEW\_ITEM\_GetInfo()

#### Description

Returns a structure with information about the given item.

#### Prototype

```
void TREEVIEW_ITEM_GetInfo(TREEVIEW_ITEM_Handle hItem,  
                           TREEVIEW_ITEM_INFO * pInfo);
```

#### Parameters

Parameter	Description
<code>hItem</code>	Handle of TREEVIEW item.
<code>pInfo</code>	Pointer to a TREEVIEW_ITEM_INFO structure to be filled by the function.

#### Additional information

The elements of the information structure are explained under *TREEVIEW\_ITEM\_INFO* on page 2607.

### 7.2.34.6.2.9 TREEVIEW\_ITEM\_GetText()

#### Description

Returns the item text of the given TREEVIEW item.

#### Prototype

```
void TREEVIEW_ITEM_GetText(TREEVIEW_ITEM_Handle hItem,  
                           U8 * pBuffer,  
                           int MaxNumBytes);
```

#### Parameters

Parameter	Description
<a href="#">hItem</a>	Handle of TREEVIEW item.
<a href="#">pBuffer</a>	Pointer to buffer filled by the function.
<a href="#">MaxNumBytes</a>	Size of the buffer in bytes.

#### Additional information

If [MaxNumBytes](#) is less than the item text length the buffer is filled with the first [MaxNumBytes](#) of the item text.

### 7.2.34.6.2.10 TREEVIEW\_ITEM\_GetUserData()

#### Description

The function returns the 32 bit value associated with the given treeview item which can be used by the application program.

#### Prototype

```
U32 TREEVIEW_ITEM_GetUserData(TREEVIEW_ITEM_Handle hItem);
```

#### Parameters

Parameter	Description
<code>hItem</code>	Handle of TREEVIEW item.

### 7.2.34.6.2.11 TREEVIEW\_ITEM\_SetImage()

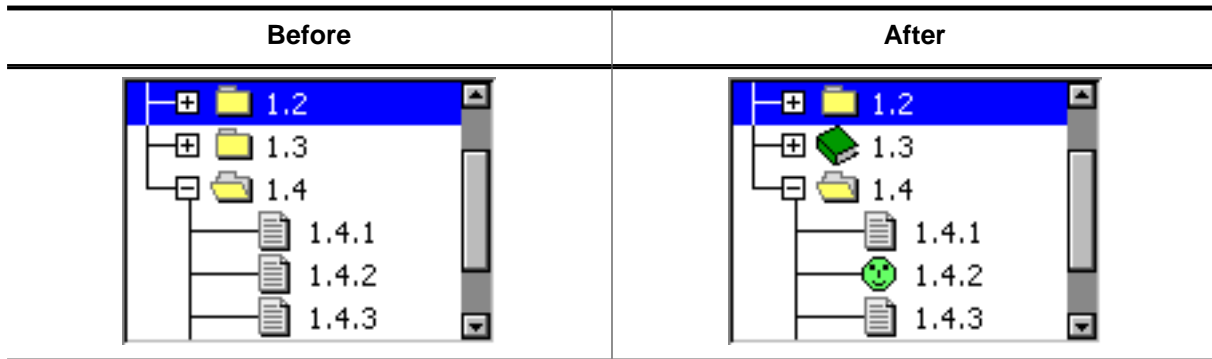

#### Description

The function sets images to be used only with the given TREEVIEW item.

#### Prototype

```
void TREEVIEW_ITEM_SetImage(    TREEVIEW_ITEM_Handle  hItem,
                               int                        Index,
                               const GUI_BITMAP          * pBitmap);
```

#### Parameters

Parameter	Description
<code>hItem</code>	Handle of TREEVIEW item.
<code>Index</code>	See <i>TREEVIEW bitmap indexes</i> on page 2608. Only the first three values <b>...CLOSED</b> , <b>...OPEN</b> and <b>...LEAF</b> may be used.
<code>pBitmap</code>	Pointer to bitmap structure to be used.

#### Additional information

This function 'overwrites' the default images of the widget. If no individual image is set the default image is used.

### 7.2.34.6.2.12 TREEVIEW\_ITEM\_SetText()

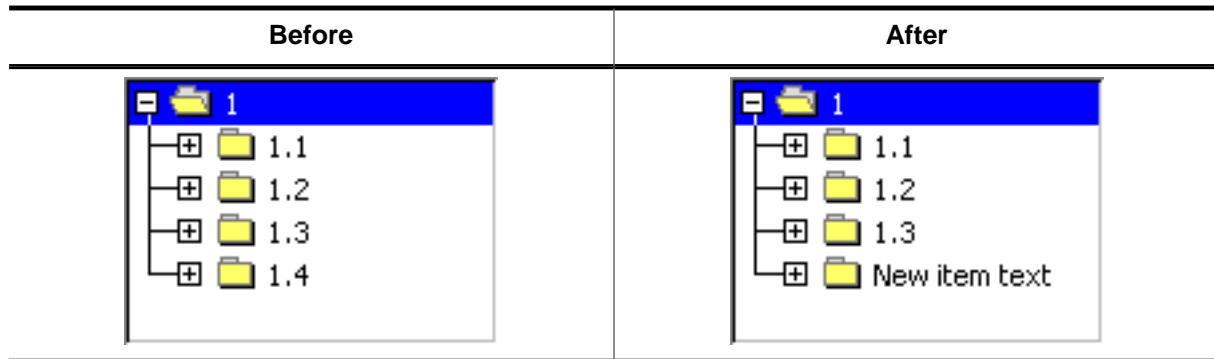

#### Description

The function sets the text of the given item.

#### Prototype

```
TREEVIEW_ITEM_Handle TREEVIEW_ITEM_SetText(    TREEVIEW_ITEM_Handle  hItem,
                                               const char          * s);
```

#### Parameters

Parameter	Description
<code>hItem</code>	Handle of TREEVIEW item.
<code>s</code>	Pointer to text to be used.

#### Return value

Handle of the TREEVIEW item with the new text.

#### Additional information

The text will be copied into the treeview item. Note that using this function changes the handle of the item. After calling this function, the new handle needs to be used.

### 7.2.34.6.2.13 TREEVIEW\_ITEM\_SetUserData()

#### Description

The function sets a 32 bit value associated with the given treeview item which can be used by the application program.

#### Prototype

```
void TREEVIEW_ITEM_SetUserData(TREEVIEW_ITEM_Handle hItem,  
                               U32                      UserData);
```

#### Parameters

Parameter	Description
<code>hItem</code>	Handle of TREEVIEW item.
<code>UserData</code>	32 bit value to be used by the application program.

### 7.2.34.6.3 Data structures

#### 7.2.34.6.3.1 TREEVIEW\_ITEM\_INFO

##### Description

Structure that contains information about a node in a TREEVIEW widget.

##### Type definition

```
typedef struct {  
    int  IsNode;  
    int  IsExpanded;  
    int  HasLines;  
    int  HasRowSelect;  
    int  Level;  
} TREEVIEW_ITEM_INFO;
```

##### Structure members

Member	Description
<a href="#">IsNode</a>	1 if item is a node, 0 if not.
<a href="#">IsExpanded</a>	1 if item (node) is open, 0 if closed.
<a href="#">HasLines</a>	1 if joining lines are visible, 0 if not.
<a href="#">HasRowSelect</a>	1 if row selection is active, 0 if not.
<a href="#">Level</a>	Indentation level of item.

## 7.2.34.6.4 Defines

### 7.2.34.6.4.1 TREEVIEW bitmap indexes

#### Description

Bitmap indexes used by the TREEVIEW widget. Refer to `TREEVIEW_SetImage()`.

#### Definition

```
#define TREEVIEW_BI_CLOSED    0
#define TREEVIEW_BI_OPEN     1
#define TREEVIEW_BI_LEAF     2
#define TREEVIEW_BI_PLUS     3
#define TREEVIEW_BI_MINUS    4
#define TREEVIEW_BI_PM       5
```

#### Symbols

Definition	Description
<code>TREEVIEW_BI_CLOSED</code>	Image of closed nodes.
<code>TREEVIEW_BI_OPEN</code>	Image of open nodes.
<code>TREEVIEW_BI_LEAF</code>	Image of leaf.
<code>TREEVIEW_BI_PLUS</code>	Plus sign of closed nodes.
<code>TREEVIEW_BI_MINUS</code>	Minus sign of open nodes.
<code>TREEVIEW_BI_PM</code>	Used by <code>TREEVIEW_SetBitmapOffset()</code> for setting the offset of the plus/minus bitmaps.



### 7.2.34.6.4.2 TREEVIEW color indexes

#### Description

Color indexes used by the TREEVIEW widget.

#### Definition

```
#define TREEVIEW_CI_UNSEL    0
#define TREEVIEW_CI_SEL     1
#define TREEVIEW_CI_DISABLED 2
```

#### Symbols

Definition	Description
TREEVIEW_CI_UNSEL	Color of unselected element.
TREEVIEW_CI_SEL	Color of selected element.
TREEVIEW_CI_DISABLED	Color of disabled element.

### 7.2.34.6.4.3 TREEVIEW create flags

#### Description

Create flags used by the TREEVIEW widget. These flags are used for the `ExFlags` parameter of `TREEVIEW_CreateEx()`. These values can be OR-combined.

#### Definition

```
#define TREEVIEW_CF_HIDELINES      (1 << 0)
#define TREEVIEW_CF_ROWSELECT     (1 << 1)
#define TREEVIEW_CF_AUTOSCROLLBAR_H (1 << 2)
#define TREEVIEW_CF_AUTOSCROLLBAR_V (1 << 3)
```

#### Symbols

Definition	Description
<code>TREEVIEW_CF_HIDELINES</code>	Joining lines are not displayed.
<code>TREEVIEW_CF_ROWSELECT</code>	Activates row selection mode.
<code>TREEVIEW_CF_AUTOSCROLLBAR_H</code>	Enables the use of an automatic horizontal scroll bar.
<code>TREEVIEW_CF_AUTOSCROLLBAR_V</code>	Enables the use of an automatic vertical scroll bar.

#### 7.2.34.6.4.4 TREEVIEW item flags

##### Description

Flags that define the item type of a newly created TREEVIEW item.

##### Definition

```
#define TREEVIEW_ITEM_TYPE_LEAF    (0 << 0)
#define TREEVIEW_ITEM_TYPE_NODE    (1 << 0)
```

##### Symbols

Definition	Description
<code>TREEVIEW_ITEM_TYPE_LEAF</code>	Used to create a leaf.
<code>TREEVIEW_ITEM_TYPE_NODE</code>	Used to create a node.

### 7.2.34.6.4.5 TREEVIEW position flags (get)

#### Description

These flags are used to specify a position when retrieving an item of the TREEVIEW widget using the routine `TREEVIEW_GetItem()`.

#### Definition

```
#define TREEVIEW_GET_FIRST      0
#define TREEVIEW_GET_LAST      1
#define TREEVIEW_GET_NEXT_SIBLING  2
#define TREEVIEW_GET_PREV_SIBLING  3
#define TREEVIEW_GET_FIRST_CHILD  4
#define TREEVIEW_GET_PARENT      5
```

#### Symbols

Definition	Description
<code>TREEVIEW_GET_FIRST</code>	Returns the first item of the TREEVIEW widget. Parameter <code>hItem</code> is not required and can be 0.
<code>TREEVIEW_GET_LAST</code>	Returns the last item of the TREEVIEW widget. Parameter <code>hItem</code> is not required and can be 0.
<code>TREEVIEW_GET_NEXT_SIBLING</code>	Returns the next child item of the parent node of <code>hItem</code> .
<code>TREEVIEW_GET_PREV_SIBLING</code>	Returns the previous child item of the parent node of <code>hItem</code> .
<code>TREEVIEW_GET_FIRST_CHILD</code>	Returns the first child of the given node.
<code>TREEVIEW_GET_PARENT</code>	Returns the parent node of the given item.

### 7.2.34.6.4.6 TREEVIEW position flags (insert)

#### Description

These flags are used to specify a position when creating and inserting a new item into the TREEVIEW widget.

#### Definition

```
#define TREEVIEW_INSERT_ABOVE      0
#define TREEVIEW_INSERT_BELOW     1
#define TREEVIEW_INSERT_FIRST_CHILD 2
```

#### Symbols

Definition	Description
TREEVIEW_INSERT_ABOVE	Attaches the item above the given position at the same indent level as the given position.
TREEVIEW_INSERT_BELOW	Attaches the item below the given position at the same indent level as the given position.
TREEVIEW_INSERT_FIRST_CHILD	Attaches the item below the given position by indenting it. The given position needs to be a node level.

### 7.2.34.6.4.7 TREEVIEW selection modes

#### Description

Flags that are used to define the selection mode of a TREEVIEW widget. Refer to `TREEVIEW_SetSelMode()` for more information.

#### Definition

```
#define TREEVIEW_SELMODE_ROW      1
#define TREEVIEW_SELMODE_TEXT    0
```

#### Symbols

Definition	Description
<code>TREEVIEW_SELMODE_ROW</code>	Activates row selection mode.
<code>TREEVIEW_SELMODE_TEXT</code>	Activates text selection mode.

## 7.2.34.7 Example

The `Sample` folder contains the following example which shows how the widget can be used:

- `WIDGET_TreeviewTryit.c`

### Note

Several other examples also make use of this widget and may also be helpful to get familiar with the widget.

### Screenshot of `WIDGET_TreeviewTryit.c`

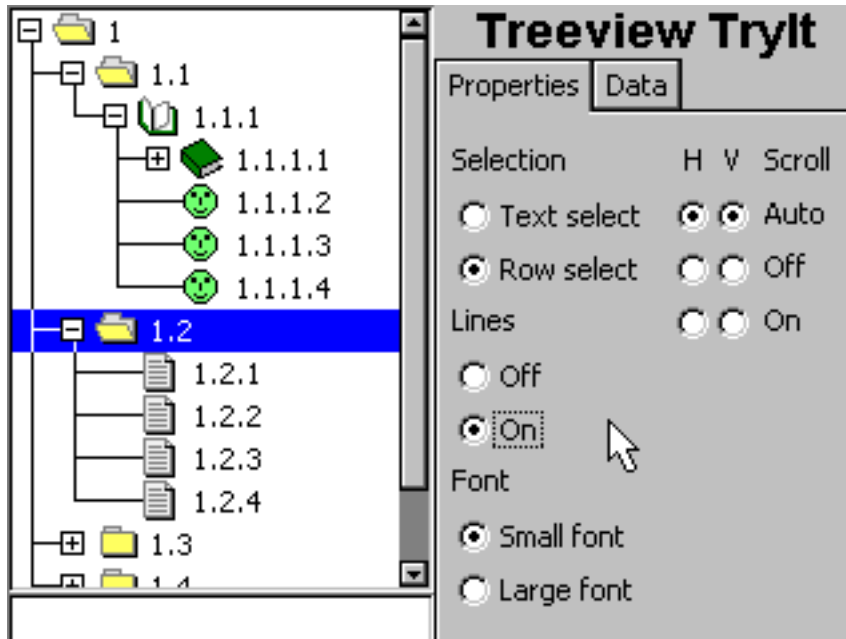

## 7.2.35 WHEEL: Wheel widget

The WHEEL widget is an updated and more versatile version of the LISTWHEEL widget.

The widget can show a given number of texts and/or bitmap arrays on a rotating wheel that the user can scroll through.

Orientation	Plain mode	Morph mode
Horizontal		
Vertical		

### Note

All WHEEL-related routines are located in the file(s) `WHEEL*.c`, `WHEEL.h`. All identifiers are prefixed `WHEEL`.

### 7.2.35.1 Structure of the WHEEL widget

#### Boxes

Around each item a frame box is drawn. The sizes for center box and the boxes that are not in the center can be set with `WHEEL_SetSizesPlain()` or `WHEEL_SetSizesMorph()`, respectively, depending on the selected mode.

The fill color, frame color, radius and line thickness can be set with `WHEEL_SetBox()`.

Optionally, different box properties can be set to the center item box with `WHEEL_SetCenterBox()`.

#### Center item

The center item is the item currently in the middle of the WHEEL list. To highlight the center item and distinguish it from the other items, specific center properties can be set to the boxes, texts and bitmaps.

The center item is also considered as the selected item. Its index can be retrieved with `WHEEL_GetSel()`.

#### Text and bitmap lists

The content of the WHEEL boxes are a number of text lists and bitmap lists.

To add a list of texts, `WHEEL_AddText()` may be called for each text list to be added.

Optionally, different text properties can be set for the center state using `WHEEL_SetCenterTextAttrPlain()` or `WHEEL_SetCenterTextAttrMorph()`, respectively, depending on the selected mode.

To add lists of bitmaps, `WHEEL_AddBitmaps()` may be called for each bitmap list to be added.



Optionally, different bitmaps to be displayed in the center state may be added with `WHEEL_SetCenterBitmaps()`.

### Morph mode

In morph mode the properties of an item are morphed to the center item properties, as the item is moving to the center position. These item properties are the added texts, bitmaps, colors, and so on.

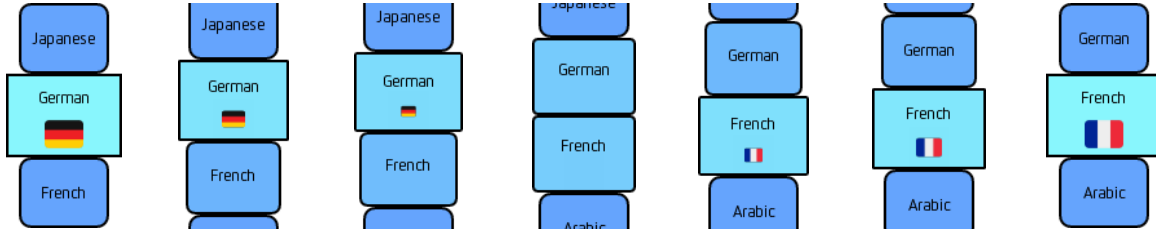

### Plain mode

In plain mode the properties are not morphed. Instead, the items are clipped once they enter the center of the WHEEL.

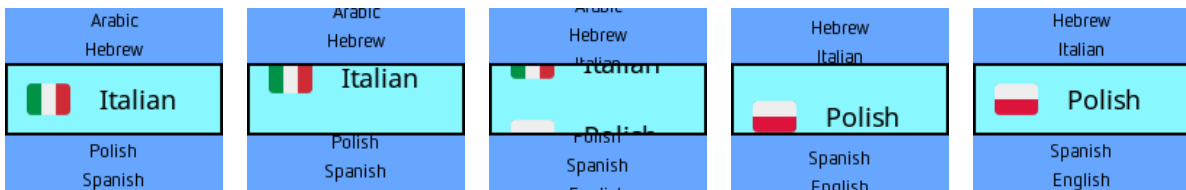

### Stop mode

In stop mode the rotating WHEEL will stop once the first or last element of the list has been reached. It can be enabled by passing the flag `WHEEL_MODE_STOP` when creating the widget.

### Endless mode

In endless mode the rotating WHEEL will continuously move without stopping when the last element has been reached. After the last element, the first element will appear again. It can be enabled by passing the flag `WHEEL_MODE_ENDLESS` when creating the widget.

### Widget orientation

The WHEEL widget can be created horizontally or vertically.

### Overlay

The overlay feature allows a maximum of three bitmaps to be added to the WHEEL. These overlay bitmaps are drawn at a certain position on top of the WHEEL items.

This can be used e.g. to create a highlighting effect. A semi-transparent bitmap can be used as an overlay to highlight the center cell, as shown below.

Without overlay	With overlay
<p>A vertical stack of five rounded rectangular items. The center item is 'Spanish' with a Spanish flag. The items above and below are 'Italian/Polish' and 'English/Chinese' respectively.</p>	<p>The same vertical stack as in the 'Without overlay' image, but with a semi-transparent dark blue overlay covering the center item and its immediate neighbors, highlighting the center cell.</p>

## 7.2.35.2 Configuration options

Type	Macro	Default	Description
N	WHEEL_PERIOD_DEFAULT	300	Motion period.

## 7.2.35.3 Predefined IDs

The following symbols define IDs which may be used to make WHEEL widgets distinguishable from creation.

```
#define GUI_ID_WHEEL0      0x390
#define GUI_ID_WHEEL1      0x391
#define GUI_ID_WHEEL2      0x392
#define GUI_ID_WHEEL3      0x393
#define GUI_ID_WHEEL4      0x394
#define GUI_ID_WHEEL5      0x395
#define GUI_ID_WHEEL6      0x396
#define GUI_ID_WHEEL7      0x397
#define GUI_ID_WHEEL8      0x398
#define GUI_ID_WHEEL9      0x399
```

## 7.2.35.4 Notification codes

The following events are sent from a WHEEL widget to its parent window as part of a WM\_NOTIFY\_PARENT message:

Message	Description
WM_NOTIFICATION_CLICKED	WHEEL has been clicked.
WM_NOTIFICATION_RELEASED	WHEEL has been released.
WM_NOTIFICATION_SEL_CHANGED	Selection of the WHEEL has changed.

## 7.2.35.5 WHEEL API

The table below lists the available emWin WHEEL-related routines in alphabetical order. Detailed descriptions of the routines follow.

### Functions

Routine	Description
WHEEL_AddBitmaps()	Adds a new list of bitmaps to the WHEEL.
WHEEL_AddText()	Adds a new list of texts to the WHEEL.
WHEEL_ClrCenterBox()	Disables the center box for the WHEEL widget.
WHEEL_ClrCenterBitmaps()	Removes the given list of center bitmaps.
WHEEL_ClrCenterText()	Clears the center properties set to the given text list.
WHEEL_CreateEx()	Creates a WHEEL widget of a specified size at a specified location.
WHEEL_CreateIndirect()	Creates a WHEEL widget from a resource table entry.
WHEEL_CreateUser()	Creates a WHEEL widget of a specified size at a specified location with optional user data.
WHEEL_GetItemText()	Retrieves a given item text.
WHEEL_GetReleasedItem()	Returns the index of the last released item of the WHEEL.

Routine	Description
<code>WHEEL_GetSel()</code>	Returns the index of the selected item.
<code>WHEEL_GetUserData()</code>	Retrieves the extra data of a WHEEL widget.
<code>WHEEL_IsMoving()</code>	Returns if the WHEEL is currently moving by an animation or motion input.
<code>WHEEL_MoveToPos()</code>	Moves the WHEEL to the position of a given index using an animation with default period.
<code>WHEEL_SetBkColor()</code>	Sets the background color for the WHEEL.
<code>WHEEL_SetBox()</code>	Sets the properties how all the boxes of all items are drawn.
<code>WHEEL_SetCenterBitmaps()</code>	Adds the given list of bitmaps to the WHEEL and sets it as center bitmaps.
<code>WHEEL_SetCenterBox()</code>	Enables a center box for the WHEEL and sets the properties for the center box.
<code>WHEEL_SetHBorder()</code>	Sets a horizontal border for all items.
<code>WHEEL_SetItemText()</code>	Sets a string in a given text list of the WHEEL.
<code>WHEEL_SetMode()</code>	Sets the mode of the WHEEL widget.
<code>WHEEL_SetOwnerDraw()</code>	Sets the WHEEL widget to be owner drawn.
<code>WHEEL_SetOverlay()</code>	Sets an overlay bitmap to the WHEEL.
<code>WHEEL_SetOverlayColor()</code>	Sets a color to the overlay bitmap set with <code>WHEEL_SetOverlay()</code> , if an alpha bitmap is being used.
<code>WHEEL_SetPeriod()</code>	Sets the motion period for a WHEEL widget.
<code>WHEEL_SetSel()</code>	Sets the selection to the given index.
<code>WHEEL_SetUserData()</code>	Sets the extra data of a WHEEL widget.
<b>“Morph mode”-only functions</b>	
<code>WHEEL_OwnerDrawMorph()</code>	Default function to draw a WHEEL item in morph mode.
<code>WHEEL_SetSizesMorph()</code>	Sets the sizes of the cells in morph mode.
<code>WHEEL_SetCellBitmapAttrMorph()</code>	Sets attributes for a bitmap list that is associated with non-center cells.
<code>WHEEL_SetCenterTextAttrMorph()</code>	Sets the center text attributes of a given text list for morph mode.
<b>“Plain mode”-only functions</b>	
<code>WHEEL_OwnerDrawPlain()</code>	Default function to draw a WHEEL item in plain mode.
<code>WHEEL_SetCellColorPlain()</code>	Sets the color of the boxes that are not in the center.
<code>WHEEL_SetCenterColorPlain()</code>	Sets the color of the center box.
<code>WHEEL_SetCenterTextAttrPlain()</code>	Sets the center text attributes of a given text list for plain mode.
<code>WHEEL_SetSizesPlain()</code>	Sets the sizes of the cells in plain mode.

## Defines

Group of defines	Description
<code>WHEEL create flags</code>	WHEEL create flags to be used in the create functions.
<code>WHEEL mode flags</code>	WHEEL mode flags to select the widget's mode.
<code>WHEEL overlay indexes</code>	WHEEL overlay indexes to be used for overlay related functions.

## 7.2.35.5.1 Functions

### 7.2.35.5.1.1 WHEEL\_AddBitmaps()

#### Description

Adds a new list of bitmaps to the WHEEL.

#### Prototype

```
int WHEEL_AddBitmaps(    WHEEL_Handle    hObj,
                        const GUI_BITMAP  ** ppBitmap,
                        unsigned          NumItems,
                        U8                Align,
                        I16                xOff,
                        I16                yOff,
                        GUI_COLOR         Color);
```

#### Parameters

Parameter	Description
<a href="#">hObj</a>	Handle of WHEEL widget.
<a href="#">ppBitmap</a>	<a href="#">in</a> Pointer to an array of <code>GUI_BITMAP</code> structures.
<a href="#">NumItems</a>	Number of items in array pointed to by <a href="#">ppBitmap</a> .
<a href="#">Align</a>	Alignment to be used for the bitmaps.
<a href="#">xOff</a>	X-offset for the alignment in pixels.
<a href="#">yOff</a>	Y-offset for the alignment in pixels.
<a href="#">Color</a>	<code>Color</code> to be used for alpha bitmaps.

#### Return value

= -1     On error.  
 ≠ -1     Index of newly added bitmap list.

### 7.2.35.5.1.2 WHEEL\_AddText()

#### Description

Adds a new list of texts to the WHEEL.

#### Prototype

```
int WHEEL_AddText(      WHEEL_Handle      hObj,
                       const GUI_ConstString * ppText,
                       unsigned           NumItems,
                       U8                 Align,
                       I16                xOff,
                       I16                yOff,
                       GUI_COLOR          Color,
                       const GUI_FONT     * pFont);
```

#### Parameters

Parameter	Description
<code>hObj</code>	Handle of WHEEL widget.
<code>ppText</code>	<b>in</b> Pointer to an array of string pointers containing the elements to be displayed.
<code>NumItems</code>	Number of items in the array <code>ppText</code> .
<code>Align</code>	Alignment of the texts.
<code>xOff</code>	X-offset to the alignment in pixels.
<code>yOff</code>	Y-offset to the alignment in pixels.
<code>Color</code>	Text color to be used.
<code>pFont</code>	<b>in</b> Font to be used.

#### Return value

= -1     On error.  
 ≠ -1     Index of newly added text list.

### 7.2.35.5.1.3 WHEEL\_ClrCenterBox()

#### Description

Disables the center box for the WHEEL widget. The properties set with `WHEEL_SetBox()` will be used for the center box.

#### Prototype

```
void WHEEL_ClrCenterBox(WHEEL_Handle hObj);
```

#### Parameters

Parameter	Description
<code>hObj</code>	Handle of WHEEL widget.

#### 7.2.35.5.1.4 WHEEL\_ClrCenterBitmaps()

##### Description

Removes the given list of center bitmaps.

##### Prototype

```
void WHEEL_ClrCenterBitmaps(WHEEL_Handle hObj,  
                             unsigned      Index);
```

##### Parameters

Parameter	Description
<a href="#">hObj</a>	Handle of WHEEL widget.
<a href="#">Index</a>	<a href="#">Index</a> of the bitmap list to be removed.



### 7.2.35.5.1.5 WHEEL\_ClrCenterText()

#### Description

Clears the center properties set to the given text list.

#### Prototype

```
void WHEEL_ClrCenterText(WHEEL_Handle hObj,  
                        unsigned Index);
```

#### Parameters

Parameter	Description
<a href="#">hObj</a>	Handle of WHEEL widget.
<a href="#">Index</a>	<a href="#">Index</a> of the text list.

### 7.2.35.5.1.6 WHEEL\_CreateEx()

#### Description

Creates a WHEEL widget of a specified size at a specified location.

#### Prototype

```
WHEEL_Handle WHEEL_CreateEx(int    x0,
                             int    y0,
                             int    xSize,
                             int    ySize,
                             WM_HWIN hParent,
                             int    WinFlags,
                             int    ExFlags,
                             int    Id);
```

#### Parameters

Parameter	Description
<code>x0</code>	Leftmost pixel of the widget (in parent coordinates).
<code>y0</code>	Topmost pixel of the widget (in parent coordinates).
<code>xSize</code>	Horizontal size of the widget (in pixels).
<code>ySize</code>	Vertical size of the widget (in pixels).
<code>NumItems</code>	Number of items of the WHEEL.
<code>hParent</code>	Handle of parent window. If 0, the new WHEEL widget will be a child of the desktop (top-level window).
<code>WinFlags</code>	Window create flags. Typically <code>WM_CF_SHOW</code> in order to make the widget visible immediately (refer to <i>Window create flags</i> on page 1146 for a list of available parameter values).
<code>ExFlags</code>	OR-combination of special creation flags. See <i>WHEEL create flags</i> on page 2667 for a list of permitted values.
<code>Id</code>	Window ID of the widget.

#### Return value

- = 0      Creation of the WHEEL failed.
- ≠ 0     Handle of the created WHEEL widget.

### 7.2.35.5.1.7 WHEEL\_CreateIndirect()

#### Description

Prototype explained at the beginning of the chapter as `<WIDGET>_CreateIndirect()` on page 1161.

### 7.2.35.5.1.8 WHEEL\_CreateUser()

#### Description

Creates a WHEEL widget of a specified size at a specified location with optional user data.

#### Prototype

```
WHEEL_Handle WHEEL_CreateUser(int    x0,
                               int    y0,
                               int    xSize,
                               int    ySize,
                               WM_HWIN hParent,
                               int    WinFlags,
                               int    ExFlags,
                               int    Id,
                               int    NumExtraBytes);
```

#### Parameters

Parameter	Description
<code>x0</code>	Leftmost pixel of the widget (in parent coordinates).
<code>y0</code>	Topmost pixel of the widget (in parent coordinates).
<code>xSize</code>	Horizontal size of the widget (in pixels).
<code>ySize</code>	Vertical size of the widget (in pixels).
<code>NumItems</code>	Number of items of the WHEEL.
<code>hParent</code>	Handle of parent window. If 0, the new WHEEL widget will be a child of the desktop (top-level window).
<code>WinFlags</code>	Window create flags. Typically <code>WM_CF_SHOW</code> in order to make the widget visible immediately (refer to <i>Window create flags</i> on page 1146 for a list of available parameter values).
<code>ExFlags</code>	OR-combination of special creation flags. See <i>WHEEL create flags</i> on page 2667 for a list of permitted values.
<code>Id</code>	Window ID of the widget.
<code>NumExtraBytes</code>	Number of additional bytes to be allocated for user data.

### 7.2.35.5.1.9 WHEEL\_GetDefaultPeriod()

#### Description

Returns the default period that is used for newly created WHEEL widgets.

#### Prototype

```
int WHEEL_GetDefaultPeriod(void);
```

#### Return value

Default period for new WHEEL widgets.

### 7.2.35.5.1.10 WHEEL\_GetItemText()

#### Description

Retrieves a given item text.

#### Prototype

```
int WHEEL_GetItemText(WHEEL_Handle hObj,
                     unsigned Index,
                     unsigned Row,
                     char * pBuffer,
                     int MaxLen);
```

#### Parameters

Parameter	Description
<code>hObj</code>	Handle of WHEEL widget.
<code>IndexText</code>	Index of the text list.
<code>IndexItem</code>	Index of the item in the text list.
<code>pBuffer</code>	<b>out</b> Pointer to a char array to store the text.
<code>MaxLen</code>	Size of the buffer.

#### Return value

0 On success.  
1 On error.

### 7.2.35.5.1.11 WHEEL\_DelItemText()

#### Description

Deletes a given text from a text list.

#### Prototype

```
int WHEEL_DelItemText(WHEEL_Handle hObj,  
                     unsigned      Index,  
                     unsigned      Row);
```

#### Parameters

Parameter	Description
<a href="#">hObj</a>	Handle of WHEEL widget.
<a href="#">Index</a>	<a href="#">Index</a> of text list.
<a href="#">Row</a>	<a href="#">Index</a> of text item to be deleted.

#### Return value

0        On success.  
1        On error.

### 7.2.35.5.1.12 WHEEL\_GetItemText()

#### Description

Retrieves a given item text.

#### Prototype

```
int WHEEL_GetItemText(WHEEL_Handle hObj,  
                     unsigned Index,  
                     unsigned Row,  
                     char * pBuffer,  
                     int MaxLen);
```

#### Parameters

Parameter	Description
<code>hObj</code>	Handle of WHEEL widget.
<code>IndexText</code>	Index of the text list.
<code>IndexItem</code>	Index of the item in the text list.
<code>pBuffer</code>	<b>out</b> Pointer to a char array to store the text.
<code>MaxLen</code>	Size of the buffer.

#### Return value

0 On success.  
1 On error.



### 7.2.35.5.1.13 WHEEL\_GetNumText()

#### Description

Returns the number of text lists.

#### Prototype

```
int WHEEL_GetNumText(WHEEL_Handle hObj);
```

#### Parameters

Parameter	Description
<a href="#">hObj</a>	Handle of WHEEL widget.

#### Return value

Number of text lists added to the WHEEL.

### 7.2.35.5.1.14 WHEEL\_GetNumTextItems()

#### Description

Returns the number text items that are present in a text list.

#### Prototype

```
int WHEEL_GetNumTextItems(WHEEL_Handle hObj,  
                           unsigned      Index);
```

#### Parameters

Parameter	Description
<a href="#">hObj</a>	Handle of WHEEL widget.
<a href="#">Index</a>	<a href="#">Index</a> of the text list.

#### Return value

Number of text items in the given text list.

### 7.2.35.5.1.15 WHEEL\_GetReleasedItem()

#### Description

Returns the index of the last released item of the WHEEL.

#### Prototype

```
int WHEEL_GetReleasedItem(WHEEL_Handle hObj);
```

#### Parameters

Parameter	Description
<a href="#">hObj</a>	Handle of WHEEL widget.

#### Return value

Index of last released item.

### 7.2.35.5.1.16 WHEEL\_GetSel()

#### Description

Returns the index of the selected item. The selected item is the item that is currently in the center of the WHEEL.

#### Prototype

```
int WHEEL_GetSel(WHEEL_Handle hObj);
```

#### Parameters

Parameter	Description
<code>hObj</code>	Handle of WHEEL widget.

#### Return value

Index of the selected item.

### 7.2.35.5.1.17 WHEEL\_GetUserData()

#### Description

Prototype explained at the beginning of the chapter as `<WIDGET>_GetUserData()` on page 1165.

### 7.2.35.5.1.18 WHEEL\_InsertItemText()

#### Description

Adds a new text to an existing text list.

#### Prototype

```
int WHEEL_InsertItemText(    WHEEL_Handle  hObj,  
                            unsigned         Index,  
                            unsigned         Row,  
                            const char      * s);
```

#### Parameters

Parameter	Description
<a href="#">hObj</a>	Handle of WHEEL widget.
<a href="#">Index</a>	<a href="#">Index</a> of text list.
<a href="#">Row</a>	<a href="#">Row</a> position to insert the string into.
<a href="#">s</a>	<a href="#">in</a> Pointer to string to be inserted.

#### Return value

- 0 On success.
- 1 On error.

### 7.2.35.5.1.19 WHEEL\_IsMoving()

#### Description

Returns if the WHEEL is currently moving by an animation or motion input.

#### Prototype

```
int WHEEL_IsMoving(WHEEL_Handle hObj);
```

#### Parameters

Parameter	Description
<a href="#">hObj</a>	Handle of WHEEL widget.

#### Return value

- 0 WHEEL is not moving.
- 1 WHEEL is moving.

### 7.2.35.5.1.20 WHEEL\_MoveToPos()

#### Description

Moves the WHEEL to the position of a given index using an animation with default period.

#### Prototype

```
void WHEEL_MoveToPos(WHEEL_Handle hObj,  
                    int Index);
```

#### Parameters

Parameter	Description
<a href="#">hObj</a>	Handle of WHEEL widget.
<a href="#">Index</a>	<a href="#">Index</a> of item to move to.



### 7.2.35.5.1.21 WHEEL\_MoveToPosEx()

#### Description

Moves the WHEEL to the position of a given index using an animation with given period.

#### Prototype

```
void WHEEL_MoveToPosEx(WHEEL_Handle hObj,  
                       int          Index,  
                       U32          Period);
```

#### Parameters

Parameter	Description
<a href="#">hObj</a>	Handle of WHEEL widget.
<a href="#">Index</a>	<a href="#">Index</a> of item to move to.
<a href="#">Period</a>	<a href="#">Period</a> in ms for the moving animation.

### 7.2.35.5.1.22 WHEEL\_OwnerDrawMorph()

#### Description

Default function to draw a WHEEL item in morph mode.

#### Prototype

```
int WHEEL_OwnerDrawMorph(const WIDGET_ITEM_DRAW_INFO * pDrawItemInfo);
```

#### Parameters

Parameter	Description
<a href="#">pDrawItemInfo</a>	Pointer to a WIDGET_ITEM_DRAW_INFO structure.

#### Additional information

This function is useful if `WHEEL_SetOwnerDraw()` has been used. [pDrawItemInfo->Col](#) is used to pass the CenterShare.

### 7.2.35.5.1.23 WHEEL\_OwnerDrawPlain()

#### Description

Default function to draw a WHEEL item in plain mode.

#### Prototype

```
int WHEEL_OwnerDrawPlain(const WIDGET_ITEM_DRAW_INFO * pDrawItemInfo);
```

#### Parameters

Parameter	Description
<a href="#">pDrawItemInfo</a>	Pointer to a WIDGET_ITEM_DRAW_INFO structure.

#### Additional information

This function is useful if `WHEEL_SetOwnerDraw()` has been used. [pDrawItemInfo->Col](#) is used to pass the subindex.

### 7.2.35.5.1.24 WHEEL\_SetAlign()

#### Description

Sets the alignment of a WHEEL widget.

#### Prototype

```
void WHEEL_SetAlign(WHEEL_Handle hObj,  
                   U8           Align);
```

#### Parameters

Parameter	Description
<a href="#">hObj</a>	Handle of WHEEL widget.
<a href="#">Align</a>	New alignment.

### 7.2.35.5.1.25 WHEEL\_SetBkColor()

#### Description

Sets the background color for the WHEEL.

#### Prototype

```
void WHEEL_SetBkColor(WHEEL_Handle hObj,  
                     GUI_COLOR   BkColor);
```

#### Parameters

Parameter	Description
<code>hObj</code>	Handle of WHEEL widget.
<code>BkColor</code>	Background color for the WHEEL widget.

### 7.2.35.5.1.26 WHEEL\_SetBox()

#### Description

Sets the properties how all the boxes of all items are drawn.

#### Prototype

```
void WHEEL_SetBox(WHEEL_Handle hObj,  
                 GUI_COLOR   Color,  
                 GUI_COLOR   FrameColor,  
                 U8          FrameRadius,  
                 U8          FrameSize);
```

#### Parameters

Parameter	Description
<code>hObj</code>	Handle of WHEEL widget.
<code>Color</code>	Fill color of the box.
<code>FrameColor</code>	Frame color of the box.
<code>FrameRadius</code>	Radius of the box.
<code>FrameSize</code>	Frame thickness of the box.

### 7.2.35.5.1.27 WHEEL\_SetCenterBitmapAttr()

#### Description

Sets the properties to the given center bitmaps.

#### Prototype

```
void WHEEL_SetCenterBitmapAttr(WHEEL_Handle hObj,
                               unsigned      Index,
                               U8           Align,
                               I16          xOff,
                               I16          yOff,
                               GUI_COLOR    Color);
```

#### Parameters

Parameter	Description
<code>hObj</code>	Handle of WHEEL widget.
<code>Index</code>	<code>Index</code> of the bitmap list.
<code>Align</code>	New bitmap alignment to be set.
<code>xOff</code>	x-Offset to the alignment of the bitmap.
<code>yOff</code>	y-Offset to the alignment of the bitmap.
<code>Color</code>	<code>Color</code> to be used by the bitmap (only for alpha bitmaps).

### 7.2.35.5.1.28 WHEEL\_SetCenterBitmaps()

#### Description

Adds the given list of bitmaps to the WHEEL and sets it as center bitmaps. This means they will only be displayed in the center cell.

#### Prototype

```
void WHEEL_SetCenterBitmaps(    WHEEL_Handle    hObj,
                               unsigned              Index,
                               const GUI_BITMAP     ** ppBitmap,
                               unsigned              NumItems,
                               U8                    Align,
                               I16                   xOff,
                               I16                   yOff,
                               GUI_COLOR             Color);
```

#### Parameters

Parameter	Description
<code>hObj</code>	Handle of WHEEL widget.
<code>Index</code>	Zero-based index of non-center bitmap list this center bitmap list should be associated with.
<code>ppBitmap</code>	<b>in</b> Pointer to array of <code>GUI_BITMAP</code> pointers to be added.
<code>NumItems</code>	Number of items in the list pointed to by <code>ppBitmap</code> .
<code>Align</code>	Alignment to be used for the bitmaps.
<code>xOff</code>	x-Offset to the alignment.
<code>yOff</code>	y-Offset to the alignment.
<code>Color</code>	<code>Color</code> to be used for the bitmaps (only for alpha bitmaps).



### 7.2.35.5.1.29 WHEEL\_SetCenterBox()

#### Description

Enables a center box for the WHEEL and sets the properties for the center box.

#### Prototype

```
void WHEEL_SetCenterBox(WHEEL_Handle hObj,  
                        GUI_COLOR    Color,  
                        GUI_COLOR    FrameColor,  
                        U8            FrameRadius,  
                        U8            FrameSize);
```

#### Parameters

Parameter	Description
<a href="#">hObj</a>	Handle of WHEEL widget.
<a href="#">Color</a>	Fill color of the center box.
<a href="#">FrameColor</a>	Frame color of the center box.
<a href="#">FrameRadius</a>	Radius of the center box.
<a href="#">FrameSize</a>	Frame thickness of the center box.

### 7.2.35.5.1.30 WHEEL\_SetCenterColorPlain()

#### Description

Sets the color of the center box. This function is to be used if the WHEEL is in plain mode.

#### Prototype

```
void WHEEL_SetCenterColorPlain(WHEEL_Handle hObj,  
                               GUI_COLOR   Color);
```

#### Parameters

Parameter	Description
<a href="#">hObj</a>	Handle of WHEEL widget.
<a href="#">Color</a>	New color.

### 7.2.35.5.1.31 WHEEL\_SetCellBitmapAttrMorph()

#### Description

Sets attributes for a bitmap list that is associated with non-center cells. Only to be used for WHEELs in morph mode.

#### Prototype

```
void WHEEL_SetCellBitmapAttrMorph(WHEEL_Handle hObj,
                                   unsigned      Index,
                                   U8           Align,
                                   I16         xOff,
                                   I16         yOff,
                                   GUI_COLOR    Color);
```

#### Parameters

Parameter	Description
<code>hObj</code>	Handle of WHEEL widget.
<code>Index</code>	Zero-based index of bitmap list.
<code>Align</code>	New alignment to be set for the bitmaps.
<code>xOff</code>	x-Offset to the alignment.
<code>yOff</code>	y-Offset to the alignment.
<code>Color</code>	<code>Color</code> to be used (only for alpha bitmaps).

### 7.2.35.5.1.32 WHEEL\_SetCellColorPlain()

#### Description

Sets the color of the boxes that are not in the center. This function is to be used if the WHEEL is in plain mode.

#### Prototype

```
void WHEEL_SetCellColorPlain(WHEEL_Handle hObj,  
                             GUI_COLOR   Color);
```

#### Parameters

Parameter	Description
<code>hObj</code>	Handle of WHEEL widget.
<code>Color</code>	New color.

### 7.2.35.5.1.33 WHEEL\_SetCenterTextAttrMorph()

#### Description

Sets the center text attributes of a given text list for morph mode.

#### Prototype

```
void WHEEL_SetCenterTextAttrMorph(WHEEL_Handle hObj,  
                                   unsigned      Index,  
                                   U8           Align,  
                                   I16         xOff,  
                                   I16         yOff,  
                                   GUI_COLOR   Color);
```

#### Parameters

Parameter	Description
<code>hObj</code>	Handle of WHEEL widget.
<code>Index</code>	Zero-based index of the text list.
<code>Align</code>	Alignment to be used for the texts.
<code>xOff</code>	X-offset for the alignment in pixels.
<code>yOff</code>	Y-offset for the alignment in pixels.
<code>Color</code>	<code>Color</code> to be used for the texts.

### 7.2.35.5.1.34 WHEEL\_SetCenterTextAttrPlain()

#### Description

Sets the center text attributes of a given text list for plain mode.

#### Prototype

```
void WHEEL_SetCenterTextAttrPlain(    WHEEL_Handle  hObj,
                                     unsigned         Index,
                                     U8                Align,
                                     I16               xOff,
                                     I16               yOff,
                                     GUI_COLOR          Color,
                                     const GUI_FONT     * pFont);
```

#### Parameters

Parameter	Description
<code>hObj</code>	Handle of WHEEL widget.
<code>Index</code>	Zero-based index of the text list.
<code>Align</code>	Alignment to be used for the texts.
<code>xOff</code>	X-offset for the alignment in pixels.
<code>yOff</code>	Y-offset for the alignment in pixels.
<code>Color</code>	<code>Color</code> to be used for the texts.
<code>pFont</code>	<code>in</code> Font to be used for the texts.

### 7.2.35.5.1.35 WHEEL\_SetDefaultPeriod()

#### Description

Sets a default period that is used for newly created WHEEL widgets.

#### Prototype

```
void WHEEL_SetDefaultPeriod(int Period);
```

#### Parameters

Parameter	Description
<code>Period</code>	New period to be set.

### 7.2.35.5.1.36 WHEEL\_SetHBorder()

#### Description

Sets a horizontal border for all items.

#### Prototype

```
void WHEEL_SetHBorder(WHEEL_Handle hObj,  
                     U16           HBorder);
```

#### Parameters

Parameter	Description
<a href="#">hObj</a>	Handle of WHEEL widget.
<a href="#">HBorder</a>	Horizontal border position in px.



### 7.2.35.5.1.37 WHEEL\_SetItemText()

#### Description

Sets a string in a given text list of the WHEEL.

#### Prototype

```
int WHEEL_SetItemText(    WHEEL_Handle  hObj,
                          unsigned      Index,
                          unsigned      Row,
                          const char    * s);
```

#### Parameters

Parameter	Description
<code>hObj</code>	Handle of WHEEL widget.
<code>IndexText</code>	Index of the text list.
<code>IndexItem</code>	Index of the item in the text list.
<code>s</code>	 Pointer to a string.

#### Return value

0        On success.  
1        On error.

### 7.2.35.5.1.38 WHEEL\_SetMode()

#### Description

Sets the mode of the WHEEL widget.

#### Prototype

```
void WHEEL_SetMode(WHEEL_Handle hObj,  
                  U16           Mode);
```

#### Parameters

Parameter	Description
<a href="#">hObj</a>	Handle of WHEEL widget.
<a href="#">Mode</a>	OR-combination of mode flags, see <i>WHEEL mode flags</i> on page 2668.

### 7.2.35.5.1.39 WHEEL\_SetOverlay()

#### Description

Sets an overlay bitmap to the WHEEL. The overlay is optional.

A total of three overlay bitmaps can be set which are drawn in the order determined by the [Index](#) parameter.

#### Prototype

```
void WHEEL_SetOverlay(    WHEEL_Handle    hObj,
                        unsigned          Index,
                        const GUI_BITMAP * pBitmap,
                        U8                 Align,
                        I16                 xOff,
                        I16                 yOff);
```

#### Parameters

Parameter	Description
<a href="#">hObj</a>	Handle of WHEEL widget.
<a href="#">Index</a>	See <i>WHEEL overlay indexes</i> on page 2669.
<a href="#">pBitmap</a>	<b>in</b> Pointer to GUI_BITMAP structure.
<a href="#">Align</a>	Alignment of the bitmap.
<a href="#">xOff</a>	x-Offset to the alignment of the bitmap.
<a href="#">yOff</a>	y-Offset to the alignment of the bitmap.

### 7.2.35.5.1.40 WHEEL\_SetOverlayColor()

#### Description

Sets a color to the overlay bitmap set with `WHEEL_SetOverlay()`, if an alpha bitmap is being used.

#### Prototype

```
void WHEEL_SetOverlayColor(WHEEL_Handle hObj,  
                           unsigned      Index,  
                           GUI_COLOR     Color);
```

#### Parameters

Parameter	Description
<code>hObj</code>	Handle of WHEEL widget.
<code>Index</code>	See <i>WHEEL overlay indexes</i> on page 2669.
<code>Color</code>	<code>Color</code> to be used.

### 7.2.35.5.1.41 WHEEL\_SetOwnerDraw()

#### Description

Sets the WHEEL widget to be owner drawn.

#### Prototype

```
void WHEEL_SetOwnerDraw(WHEEL_Handle hObj,  
                        WIDGET_DRAW_ITEM_FUNC * pfDrawItem);
```

#### Parameters

Parameter	Description
<code>hObj</code>	Handle of WHEEL widget.
<code>pfDrawItem</code>	Pointer to owner draw function.

#### Additional information

This function sets a function pointer to a function which will be called by the widget if a WHEEL item has to be drawn.

### 7.2.35.5.1.42 WHEEL\_SetPeriod()

#### Description

Sets the motion period for a WHEEL widget.

#### Prototype

```
void WHEEL_SetPeriod(WHEEL_Handle hObj,  
                    U32          Period);
```

#### Parameters

Parameter	Description
<a href="#">hObj</a>	Handle of WHEEL widget.
<a href="#">Period</a>	New period.

### 7.2.35.5.1.43 WHEEL\_SetSel()

#### Description

Sets the selection to the given index. The new selection will be in the center of the WHEEL.

#### Prototype

```
void WHEEL_SetSel(WHEEL_Handle hObj,  
                 int Index);
```

#### Parameters

Parameter	Description
<a href="#">hObj</a>	Handle of WHEEL widget.
<a href="#">Index</a>	<a href="#">Index</a> of new selected item.

### 7.2.35.5.1.44 WHEEL\_SetSizesMorph()

#### Description

Sets the sizes of the cells in morph mode.

#### Prototype

```
void WHEEL_SetSizesMorph(WHEEL_Handle hObj,
                        U16           CellSize,
                        U16           CenterSize,
                        U16           Cutaway,
                        U8            AlignCutaway);
```

#### Parameters

Parameter	Description
<a href="#">hObj</a>	Handle of WHEEL widget.
<a href="#">CellSize</a>	Size of non-center cells.
<a href="#">CenterSize</a>	Size of the center cell.
<a href="#">Cutaway</a>	Number of pixels that are cut away from non-center cells.
<a href="#">AlignCutaway</a>	Alignment of non-center cells when <a href="#">Cutaway</a> is set.



### 7.2.35.5.1.45 WHEEL\_SetSizesPlain()

#### Description

Sets the sizes of the cells in plain mode.

#### Prototype

```
void WHEEL_SetSizesPlain(WHEEL_Handle hObj,  
                        U16           CellSize,  
                        U16           CenterSize);
```

#### Parameters

Parameter	Description
<a href="#">hObj</a>	Handle of WHEEL widget.
<a href="#">CellSize</a>	Size of non-center cells.
<a href="#">CenterSize</a>	Size of the center cell.

### 7.2.35.5.1.46 WHEEL\_SetUserData()

#### Description

Prototype explained at the beginning of the chapter as `<WIDGET>_SetUserData()` on page 1166.

## 7.2.35.5.2 Defines

### 7.2.35.5.2.1 WHEEL create flags

#### Description

Flags that are passed when the WHEEL is created.

#### Definition

```
#define WHEEL_CF_HORIZONTAL    0
#define WHEEL_CF_VERTICAL    WIDGET_CF_VERTICAL
```

#### Symbols

Definition	Description
<a href="#">WHEEL_CF_HORIZONTAL</a>	The WHEEL moves horizontally.
<a href="#">WHEEL_CF_VERTICAL</a>	The WHEEL moves vertically.

### 7.2.35.5.2 WHEEL mode flags

#### Description

Flags that define the movement behavior of the widget and the WHEEL's cells.

#### Definition

```
#define WHEEL_MODE_ENDLESS    0
#define WHEEL_MODE_STOP      WIDGET_STATE_USER0
#define WHEEL_MODE_PLAIN     0
#define WHEEL_MODE_MORPH     WIDGET_STATE_USER1
```

#### Symbols

Definition	Description
<a href="#">WHEEL_MODE_ENDLESS</a>	The WHEEL's list moves continuously and does not stop when the end of the list has been reached.
<a href="#">WHEEL_MODE_STOP</a>	The WHEEL's list moves from the first element to the last one and stops when the last element has been reached.
<a href="#">WHEEL_MODE_PLAIN</a>	Puts the WHEEL into plain mode. While the list is moving the items don't morph into one another, but the center item is highlighted.
<a href="#">WHEEL_MODE_MORPH</a>	Puts the WHEEL into morph mode. While the list is moving one item morphs into the next item.

#### Additional information

A more detailed explanation of the WHEEL modes can be found at the beginning of the chapter.

### 7.2.35.5.2.3 WHEEL overlay indexes

#### Description

Indexes for the WHEEL's overlay bitmaps.

#### Definition

```
#define WHEEL_OI_FIRST      0
#define WHEEL_OI_SECOND    1
#define WHEEL_OI_THIRD     2
```

#### Symbols

Definition	Description
<a href="#">WHEEL_OI_FIRST</a>	First overlay bitmap that is drawn above the WHEEL.
<a href="#">WHEEL_OI_SECOND</a>	Second overlay bitmap that is drawn above the WHEEL.
<a href="#">WHEEL_OI_THIRD</a>	Third overlay bitmap that is drawn above the WHEEL.

## 7.2.36 WINDOW: Window widget

The WINDOW widget is used to create a dialog window from a resource table. It should be used if the dialog should not look like a frame window. The window widget acts as background and as a container for child windows: It can contain child windows and fills the background, typically with gray.

It behaves much like a frame-window without frame and title bar and is used for dialogs.

### Note

All WINDOW-related routines are located in the file(s) `WINDOW.c`, `DIALOG.h`.

### 7.2.36.1 Configuration options

Type	Macro	Default	Description
S	WINDOW_BKCOLOR_DEFAULT (with WIDGET_USE_FLEX_SKIN = 0) (with WIDGET_USE_FLEX_SKIN = 1)	0xC0C0C0 GUI_WHITE	Default background color for new WINDOW widgets.

### 7.2.36.2 Keyboard reaction

The widget can not gain the input focus and does not react on keyboard input.

### 7.2.36.3 WINDOW API

The table below lists the available emWin WINDOW-related routines in alphabetical order. Detailed descriptions of the routines follow.

Routine	Description
<code>WINDOW_CreateEx()</code>	Creates a WINDOW widget.
<code>WINDOW_CreateIndirect()</code>	Creates a WINDOW widget from a resource table entry.
<code>WINDOW_CreateUser()</code>	Creates a WINDOW widget using extra bytes as user data.
<code>WINDOW_GetUserData()</code>	Retrieves the data set with <code>WINDOW_SetUserData()</code> .
<code>WINDOW_SetBkColor()</code>	Sets the background color for the given WINDOW widget.
<code>WINDOW_SetDefaultBkColor()</code>	Sets the default background color used for WINDOW widgets.
<code>WINDOW_SetUserData()</code>	Sets the extra data of a WINDOW widget.

### 7.2.36.3.1 WINDOW\_CreateEx()

#### Description

Creates a WINDOW widget of a specified size at a specified location.

#### Prototype

```
WM_HWIN WINDOW_CreateEx(int          x0,
                        int          y0,
                        int          xSize,
                        int          ySize,
                        WM_HWIN      hParent,
                        int          WinFlags,
                        int          ExFlags,
                        int          Id,
                        WM_CALLBACK * cb);
```

#### Parameters

Parameter	Description
<code>x0</code>	Leftmost pixel of the WINDOW widget (in parent coordinates)
<code>y0</code>	Topmost pixel of the WINDOW widget (in parent coordinates)
<code>xSize</code>	Size of the WINDOW widget in X
<code>ySize</code>	Size of the WINDOW widget in Y
<code>hParent</code>	Handle of parent window
<code>WinFlags</code>	Window create flags. Typically <code>WM_CF_SHOW</code> in order to make the widget visible immediately (refer to <i>Window create flags</i> on page 1146 for a list of available parameter values).
<code>ExFlags</code>	Not used yet, reserved for future use
<code>Id</code>	Window ID of the WINDOW widget
<code>cb</code>	Pointer to callback routine.

#### Return value

Handle of the created WINDOW widget; 0 if the function fails.

### 7.2.36.3.2 WINDOW\_CreateIndirect()

#### Description

The prototype of this function is explained at the beginning of this chapter. Details can be found in the description of the function `<WIDGET>_CreateIndirect()` on page 1161. The element `Para` of the according `GUI_WIDGET_CREATE_INFO` structure is not used. The element `Flags` is used according to the parameter `WinFlags` of the function `WINDOW_CreateEx()`. The `Sample` folder contains the file `WIDGET_Window.c` which shows how to use the `WINDOW` widget in a dialog resource.



### 7.2.36.3.3 WINDOW\_CreateUser()

#### Description

Prototype explained at the beginning of the chapter as `<WIDGET>_CreateUser()` on page 1162. For a detailed description of the parameters the function `WINDOW_CreateEx()` can be referred to.

### 7.2.36.3.4 WINDOW\_GetUserData()

#### Description

Prototype explained at the beginning of the chapter as `<WIDGET>_GetUserData()` on page 1165.

### 7.2.36.3.5 WINDOW\_SetBkColor()

#### Description

Sets the background color for the given WINDOW widget.

#### Prototype

```
void WINDOW_SetBkColor(WM_HWIN hObj,  
                       GUI_COLOR Color);
```

#### Parameters

Parameter	Description
<code>hObj</code>	Handle of the WINDOW widget.
<code>Color</code>	Background color to be used.

### 7.2.36.3.6 WINDOW\_SetDefaultBkColor()

#### Description

Sets the default background color used for WINDOW widgets.

#### Prototype

```
void WINDOW_SetDefaultBkColor(GUI_COLOR Color);
```

#### Parameters

Parameter	Description
Color	Color to be used.

### 7.2.36.3.7 WINDOW\_SetUserData()

#### Description

Prototype explained at the beginning of the chapter as `<WIDGET>_SetUserData()` on page 1166.



## 7.2.37 Obsolete widgets

### 7.2.37.1 KNOB: Knob widget (obsolete)

**Note**

The KNOB widget is obsolete and has been replaced by the ROTARY widget!

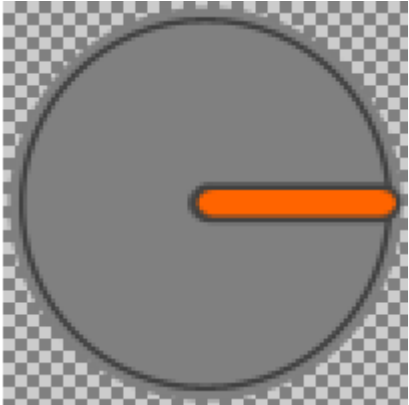
The KNOB widget is used to change a value with a knob. The KNOB widget is transparent per default and it requires a memory device containing a drawn knob to be visible. If the memory device contains transparency, any content can be shown in the background.

Drawn knob with transparency	How it appears used as KNOB widget
	

**Note**

All KNOB-related routines are in the file(s) `KNOB.c` and `KNOB.h`. All identifiers are prefixed with `KNOB`.

#### Ticks and Ticksize

A Tick describes the smallest range of movement of the KNOB widget. The smallest size of one Tick (Ticksize 1) equates 1/10 of a degree. So it takes 3600 Ticks to fulfill one round. The size of one Tick can be set with the function `KNOB_SetTickSize()`.

Examples	
Ticksize	Ticks for one round
60	60
36	100
300	12

#### 7.2.37.1.1 Requirements

This widget requires the optional memory devices. Without the optional memory devices package the widget can not be used! The memory device which contains the drawn knob will not be deleted if the KNOB widget gets deleted. Make sure to delete the memory device by yourself if it is not any longer required.

#### Memory requirements

At least the widget uses two memory devices with a color depth of 32bpp (one with the drawn knob, one for internal use). The required amount of memory depends on using an additional memory device for the background or not. Detailed information on how to calculate memory requirements can be found in the chapter *Memory Devices* on page 2916.

Approximate memory usage without a background device:  $XSIZE * 4 * YSIZE * 2$

### 7.2.37.1.2 Configuration options

Type	Macro	Default	Description
N	KNOB_BKCOLOR_DEFAULT	GUI_TRANSPARENT	Background color
N	KNOB_KEYVALUE_DEFAULT	1	Range the KNOB will rotate on one key press in 1/10 of degree.
N	KNOB_OFFSET_DEFAULT	0	An offset added to initial point of the KNOB in 1/10 of degree.
N	KNOB_PERIOD_DEFAULT	1500	Time the KNOB takes to stop in ms.
N	KNOB_SNAP_DEFAULT	0	Interval where the KNOB automatically stops in 1/10 of degree.
N	KNOB_TICKSIZE_DEFAULT	1	Size of one tick in 1/10 of degree.

### 7.2.37.1.3 Predefined IDs

The following symbols define IDs which may be used to make KNOB widgets distinguishable from creation.

```
#define GUI_ID_KNOB0    0x300
#define GUI_ID_KNOB1    0x301
#define GUI_ID_KNOB2    0x302
#define GUI_ID_KNOB3    0x303
#define GUI_ID_KNOB4    0x304
#define GUI_ID_KNOB5    0x305
#define GUI_ID_KNOB6    0x306
#define GUI_ID_KNOB7    0x307
#define GUI_ID_KNOB8    0x308
#define GUI_ID_KNOB9    0x309
```

### 7.2.37.1.4 Notification codes

The following events are sent from a KNOB widget to its parent window as part of a WM\_NOTIFY\_PARENT message:

Message	Description
WM_NOTIFICATION_CLICKED	KNOB has been clicked.
WM_NOTIFICATION_RELEASED	KNOB has been released.
WM_NOTIFICATION_MOVED_OUT	KNOB has been clicked and pointer has been moved out of the KNOB area without releasing.
WM_NOTIFICATION_VALUE_CHANGED	The value of the KNOB widget has been changed.

### 7.2.37.1.5 Keyboard reaction

The widget reacts to the following keys if it has the input focus:

Key	Reaction
GUI_KEY_RIGHT	The KNOB rotates CW.
GUI_KEY_LEFT	The KNOB rotates CCW.
GUI_KEY_DOWN	The KNOB rotates CW.
GUI_KEY_UP	The KNOB rotates CCW.

### 7.2.37.1.6 KNOB API

The table below lists the available emWin KNOB-related routines in alphabetical order. Detailed descriptions of the routines follow.

Routine	Description
<code>KNOB_AddValue()</code>	Adds a value to the position of the KNOB widget around its rotary axis.
<code>KNOB_CreateEx()</code>	Creates a KNOB widget.
<code>KNOB_CreateIndirect()</code>	Creates a KNOB widget from a resource table entry.
<code>KNOB_CreateUser()</code>	Creates a KNOB widget using extra bytes as user data.
<code>KNOB_GetUserData()</code>	Retrieves the data set with <code>KNOB_SetUserData()</code> .
<code>KNOB_GetValue()</code>	Returns the current value of the KNOB widget.
<code>KNOB_SetBkColor()</code>	Sets a color for the background of the KNOB widget.
<code>KNOB_SetBkDevice()</code>	Sets a memory device to be shown as background.
<code>KNOB_SetDevice()</code>	Sets a memory device which contains a drawn knob.
<code>KNOB_SetInvert()</code>	Inverts the value of the knob.
<code>KNOB_SetKeyValue()</code>	Sets a value which defines the movement range of the KNOB on one key press.
<code>KNOB_SetOffset()</code>	Sets an offset angle for the KNOB widget.
<code>KNOB_SetPeriod()</code>	Sets a time period which defines how long the KNOB will need to stop.
<code>KNOB_SetPos()</code>	Sets a new position for the KNOB widget around its rotary axis.
<code>KNOB_SetRange()</code>	Sets a range within the KNOB can be rotated.
<code>KNOB_SetRotateHQ()</code>	Selects high quality rotating.
<code>KNOB_SetRotateLQ()</code>	Selects low quality rotating.
<code>KNOB_SetSnap()</code>	Sets a range between snap positions where the KNOB automatically stops.
<code>KNOB_SetTickSize()</code>	Sets the size of one tick.
<code>KNOB_SetUserData()</code>	Sets the extra data of a KNOB widget.



### 7.2.37.1.6.1 KNOB\_AddValue()

#### Description

Adds a value to the position of the KNOB widget around its rotary axis.

#### Prototype

```
void KNOB_AddValue(KNOB_Handle hObj,  
                  I32          Value);
```

#### Parameters

Parameter	Description
<code>hObj</code>	Handle of the KNOB widget.
<code>Value</code>	<code>Value</code> to be added to the position around the rotary axis in ticks.

#### Additional information

A positive `Value` rotates the knob counter-clockwise and a negative `Value` clockwise.

### 7.2.37.1.6.2 KNOB\_CreateEx()

#### Description

Creates a KNOB widget of a specified size at a specified location with the possibility to assign a parent window.

#### Prototype

```
KNOB_Handle KNOB_CreateEx(int    x0,
                          int    y0,
                          int    xSize,
                          int    ySize,
                          WM_HWIN hParent,
                          int    WinFlags,
                          int    Id);
```

#### Parameters

Parameter	Description
<code>x0</code>	Leftmost pixel of the KNOB widget (in parent coordinates).
<code>y0</code>	Topmost pixel of the KNOB widget (in parent coordinates).
<code>xSize</code>	Horizontal size of the KNOB widget (in pixels).
<code>ySize</code>	Vertical size of the KNOB widget (in pixels).
<code>hParent</code>	Parent window of the KNOB widget.
<code>Id</code>	ID of the KNOB widget.
<code>WinFlags</code>	Window create flags. Typically <code>WM_CF_SHOW</code> in order to make the widget visible immediately (refer to <i>Window create flags</i> on page 1146 for a list of available parameter values).

#### Return value

Handle of the created KNOB widget.

#### Additional information

The created widget is not visible by default. In order to have the widget being drawn a Memory Device needs to be set first. Using the function `KNOB_SetDevice()` a Memory Device containing the actual knob can be set.

### 7.2.37.1.6.3 KNOB\_CreateIndirect()

#### Description

Prototype explained at the beginning of the chapter as `<WIDGET>_CreateIndirect()` on page 1161. The elements `Flags` and `Para` of the resource passed as parameter are not used.

#### 7.2.37.1.6.4 KNOB\_CreateUser()

##### Description

Prototype explained at the beginning of the chapter as `<WIDGET>_CreateUser()` on page 1162. For a detailed description of the parameters the function `KNOB_CreateEx()` can be referred to.

### 7.2.37.1.6.5 KNOB\_GetUserData()

#### Description

Prototype explained at the beginning of the chapter as `<WIDGET>_GetUserData()` on page 1165.

### 7.2.37.1.6.6 KNOB\_GetValue()

#### Description

Returns the value of the current position around its rotary axis.

#### Prototype

```
I32 KNOB_GetValue(KNOB_Handle hObj);
```

#### Parameters

Parameter	Description
<a href="#">hObj</a>	Handle of KNOB widget.

#### Return value

Value of the current position of the KNOB around its rotary axis in 1/10 of a degree.

#### Additional information

The value describes the angle in relation to the starting point. The starting point is defined by the offset which is set using the function `KNOB_SetOffset()`. Depending on the configured range (`KNOB_SetRange()`) the returned value might be more than 3600.

### 7.2.37.1.6.7 KNOB\_SetBkColor()

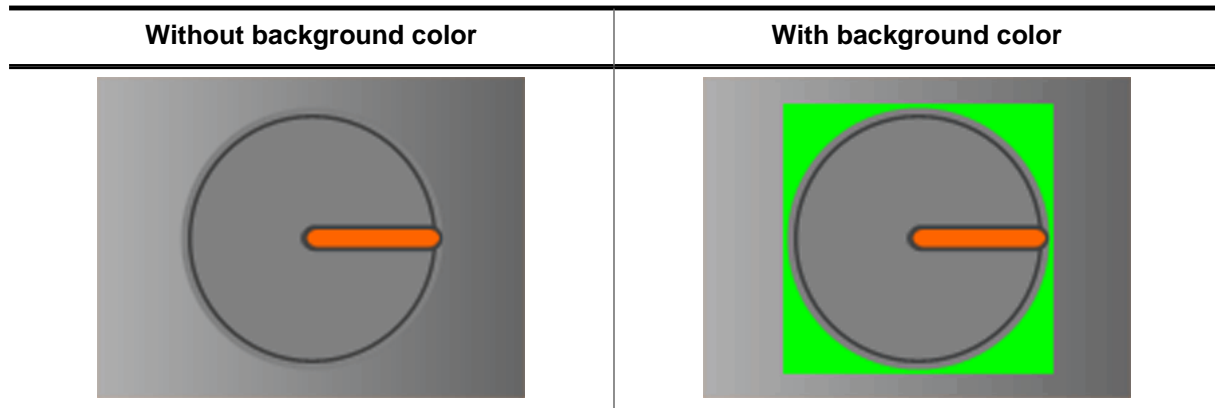

#### Description

Sets a color for the background of the KNOB widget.

#### Prototype

```
void KNOB_SetBkColor(KNOB_Handle hObj,
                    GUI_COLOR   BkColor);
```

#### Parameters

Parameter	Description
hObj	Handle of KNOB widget.
Color	Color to be set as background color.

#### Additional information

Default color is transparent. It is not possible to set semi-transparent colors, only opaque colors are allowed.

### 7.2.37.1.6.8 KNOB\_SetBkDevice()

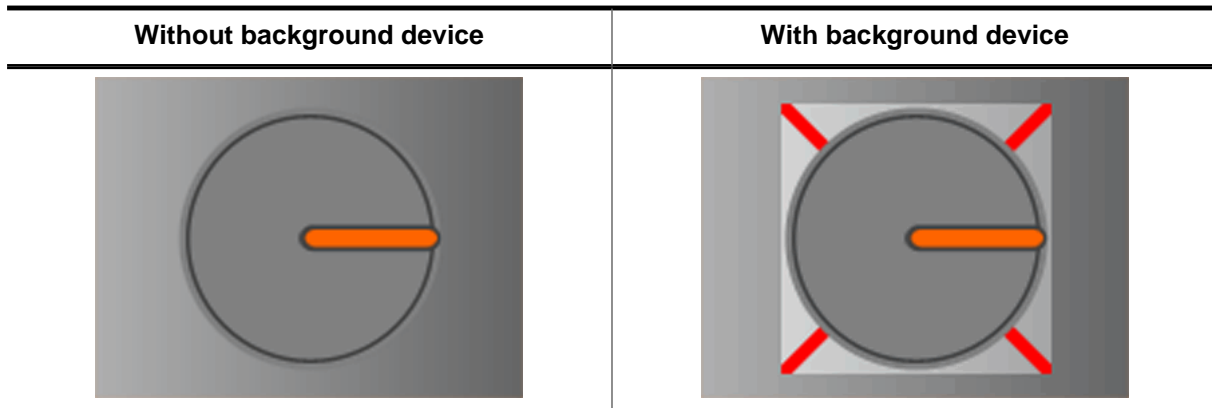

#### Description

Sets a memory device to be shown as background.

#### Prototype

```
void KNOB_SetBkDevice(KNOB_Handle      hObj,
                     GUI_MEMDEV_Handle hMemBk);
```

#### Parameters

Parameter	Description
<code>hObj</code>	Handle of KNOB widget.
<code>hMemBk</code>	Handle of a memory device which should be used as background.

#### Additional information

The widget will not delete the background device if the widget gets deleted. So make sure to delete the background device by yourself.



### 7.2.37.1.6.9 KNOB\_SetDevice()

#### Description

Sets a memory device which contains a drawn knob. This drawing defines the appearance of the knob.

#### Prototype

```
void KNOB_SetDevice(KNOB_Handle      hObj,  
                   GUI_MEMDEV_Handle hMemSrc);
```

#### Parameters

Parameter	Description
<a href="#">hObj</a>	Handle of KNOB widget.
<a href="#">hMemSrc</a>	Handle of a memory device which is used for the appearance of the KNOB.

#### Additional information

The memory device must have a color depth of 32bpp. Without setting a memory device the KNOB will be invisible.

### 7.2.37.1.6.10 KNOB\_SetInvert()

#### Description

Inverts the output and input value for the KNOB widget.

#### Prototype

```
void KNOB_SetInvert(KNOB_Handle hObj,  
                   U8          Invert);
```

#### Parameters

Parameter	Description
<code>hObj</code>	Handle of KNOB widget.
<code>Invert</code>	Enables or disables invert. Can be 1 or 0.

### 7.2.37.1.6.11 KNOB\_SetKeyValue()

#### Description

Sets a value which defines the movement range of the KNOB on one key press.

#### Prototype

```
void KNOB_SetKeyValue(KNOB_Handle hObj,  
                    I32          KeyValue);
```

#### Parameters

Parameter	Description
<a href="#">hObj</a>	Handle of KNOB widget.
<a href="#">KeyValue</a>	Value is used for the movement range on one key press. Unit is 1/10 of a degree.

#### Additional information

If a tick size larger than 1 is set the KNOB widget uses the tick size as [KeyValue](#). This function is used only if no tick size is set.

### 7.2.37.1.6.12 KNOB\_SetOffset()

#### Description

Sets an offset angle for the KNOB widget. The knob will appear rotated from the beginning of the application.

#### Prototype

```
void KNOB_SetOffset(KNOB_Handle hObj,  
                   I32          Offset);
```

#### Parameters

Parameter	Description
<code>hObj</code>	Handle of KNOB widget.
<code>Offset</code>	<code>Offset</code> position of the knob around its rotary axis in 1/10 of a degree.

### 7.2.37.1.6.13 KNOB\_SetPeriod()

#### Description

Sets a time period which defines how long the KNOB will need to stop.

#### Prototype

```
void KNOB_SetPeriod(KNOB_Handle hObj,  
                   I32          Period);
```

#### Parameters

Parameter	Description
<code>hObj</code>	Handle of KNOB widget.
<code>Period</code>	Time it takes to stop the KNOB in ms.

#### Additional information

The period can not be larger than 46340ms. Default is 1500ms.

### 7.2.37.1.6.14 KNOB\_SetPos()

#### Description

Sets a new position for the KNOB widget around its rotary axis.

#### Prototype

```
void KNOB_SetPos(KNOB_Handle hObj,  
                I32          Pos);
```

#### Parameters

Parameter	Description
<code>hObj</code>	Handle of KNOB widget.
<code>Pos</code>	New position around the rotary axis in ticks.

### 7.2.37.1.6.15 KNOB\_SetRange()

#### Description

Sets a range within the KNOB can be rotated.

#### Prototype

```
void KNOB_SetRange(KNOB_Handle hObj,
                  I32           MinRange,
                  I32           MaxRange);
```

#### Parameters

Parameter	Description
<a href="#">hObj</a>	Handle of KNOB widget.
<a href="#">MinRange</a>	The minimum of the movement range in ticks. This value defines the distance from the starting point to the minimum value which can be reached by rotating the KNOB widget clockwise. <a href="#">MinRange</a> defines the range to move clockwise. <a href="#">MaxRange</a> defines the range to move counterclockwise.
<a href="#">MaxRange</a>	The maximum of the movement range in ticks. This value defines the distance from the starting point to the maximum value which can be reached by rotating the KNOB widget counterclockwise.

#### Additional information

The difference between [MinRange](#) and [MaxRange](#) defines the movement area. If the `TICK-Size` is set to 10 and [MinRange](#) is set to 0 and [MaxRange](#) to 720 the KNOB is able to rotate twice around its rotary axis. If [MinRange](#) and [MaxRange](#) are equal the KNOB will be able to rotate freely. Since 0 is the starting point, it is recommended to include 0 in the range.

### 7.2.37.1.6.16 KNOB\_SetRotateHQ()

### 7.2.37.1.6.17 KNOB\_SetRotateLQ()

#### Description

These functions are used to choose high and low quality rotating. The LQ variant has a better performance than HQ, but the HQ variant looks better.

#### Prototypes

```
void KNOB_SetRotateHQ(KNOB_Handle hObj);
```

```
void KNOB_SetRotateLQ(KNOB_Handle hObj);
```

#### Parameters

Parameter	Description
<a href="#">hObj</a>	Handle of KNOB widget.



### 7.2.37.1.6.18 KNOB\_SetSnap()

#### Description

Sets a range between snap positions where the KNOB automatically stops. After the KNOB starts rotating it calculates the closest snap position to its stopping point and stops at this snap position. If the KNOB is released between two snap positions it rotates to the closest.

#### Prototype

```
void KNOB_SetSnap(KNOB_Handle hObj,  
                 I32          Snap);
```

#### Parameters

Parameter	Description
<a href="#">hObj</a>	Handle of KNOB widget.
<a href="#">Snap</a>	Sets the range between snap positions in ticks.

#### Additional information

If `TickSize` is set to 1 (default) and [Snap](#) is 300 every 30 degrees will be a snap position.

### 7.2.37.1.6.19 KNOB\_SetTickSize()

#### Description

Sets the tick size of the KNOB. The tick size defines the minimum movement of the knob in 1/10 of degrees.

#### Prototype

```
void KNOB_SetTickSize(KNOB_Handle hObj,  
                     I32          TickSize);
```

#### Parameters

Parameter	Description
<code>hObj</code>	Handle of KNOB widget.
<code>TickSize</code>	Sets the Ticksize of the KNOB widget.

#### Additional information

The default `TickSize` is 1, it takes 3600 Ticks to fulfill one round. For example if `TickSize` is set to 10 the minimum movement is 1 degree and it takes 360 Ticks to fulfill one round. This function should be called before any other KNOB function.

### 7.2.37.1.6.20 KNOB\_SetUserData()

#### Description

Prototype explained at the beginning of the chapter as `<WIDGET>_SetUserData()` on page 1166.

## 7.2.37.2 LISTWHEEL: Listwheel widget (obsolete)

### Note

The LISTWHEEL widget is obsolete and has been replaced with the WHEEL widget!

This widget is similar to the LISTBOX widget described earlier in this chapter. Whereas the data of a LISTBOX is selected by moving the cursor with the keyboard or by using a SCROLLBAR the LISTWHEEL works completely different: The whole data area can be moved via pointer input device (PID). Striking over the widget from top to bottom or vice versa moves the data up or downwards. When releasing the PID during the data area is moving it slows down its motion and stops by snapping in a new item at the snap position. Further the data is shown in a loop. After the last data item it continues with the first item like in a chain. So the data can be 'rotated' like a wheel:

Description	LISTWHEEL widget
<p>Application example showing three wheels for selecting a date. The example uses the owner draw mechanism to overlay the widget with a customized alpha mask for the shading effect.</p>	

The table above shows a screenshot of the example `WIDGET_ListWheel.c` located in the example folder `Sample\Tutorial\` of the emWin package.

### Note

All LISTWHEEL-related routines are located in the file(s) `LISTWHEEL*.c`, `LISTWHEEL.h`. All identifiers are prefixed `LISTWHEEL`.

### 7.2.37.2.1 Configuration options

Type	Macro	Default	Description
S	<code>LISTWHEEL_FONT_DEFAULT</code>	<code>GUI_Font13_1</code>	Font used.
N	<code>LISTWHEEL_BKCOLOR0_DEFAULT</code>	<code>GUI_WHITE</code>	Background color of normal text.
N	<code>LISTWHEEL_BKCOLOR1_DEFAULT</code>	<code>GUI_WHITE</code>	Background color of selected text.
N	<code>LISTWHEEL_TEXTCOLOR0_DEFAULT</code>	<code>GUI_BLACK</code>	Text color of normal text.
N	<code>LISTWHEEL_TEXTCOLOR1_DEFAULT</code>	<code>GUI_BLUE</code>	Text color of selected text.
N	<code>LISTWHEEL_TEXTALIGN_DEFAULT</code>	<code>GUI_TA_LEFT</code>	Text alignment.
N	<code>LISTWHEEL_DECELERATION_DEFAULT</code>	15	Deceleration value.
N	<code>LISTWHEEL_TIMER_PERIOD_DEFAULT</code>	25	Timer period.

### 7.2.37.2.2 Predefined IDs

The following symbols define IDs which may be used to make LISTWHEEL widgets distinguishable from creation.

```
#define GUI_ID_LISTVIEW0    0x200
#define GUI_ID_LISTVIEW1    0x201
#define GUI_ID_LISTVIEW2    0x202
#define GUI_ID_LISTVIEW3    0x203
#define GUI_ID_LISTVIEW4    0x204
#define GUI_ID_LISTVIEW5    0x205
#define GUI_ID_LISTVIEW6    0x206
#define GUI_ID_LISTVIEW7    0x207
#define GUI_ID_LISTVIEW8    0x208
#define GUI_ID_LISTVIEW9    0x209
```

### 7.2.37.2.3 Notification codes

The following events are sent from the widget to its parent window as part of a WM\_NOTIFY\_PARENT message:

Message	Description
WM_NOTIFICATION_CLICKED	Widget has been clicked.
WM_NOTIFICATION_RELEASED	Widget has been released.
WM_NOTIFICATION_MOVED_OUT	Widget has been clicked and pointer has been moved out of the widget without releasing.
WM_NOTIFICATION_SEL_CHANGED	An item has been snapped at the snap position.

### 7.2.37.2.4 Keyboard reaction

This widget currently does not react on keyboard input.

### 7.2.37.2.5 LISTWHEEL API

The table below lists the available emWin LISTWHEEL-related routines in alphabetical order. Detailed descriptions of the routines follow.

#### Functions

Routine	Description
<code>LISTWHEEL_AddString()</code>	Adds a new string.
<code>LISTWHEEL_CreateEx()</code>	Creates a LISTWHEEL widget.
<code>LISTWHEEL_CreateIndirect()</code>	Creates a LISTWHEEL widget from a resource table entry.
<code>LISTWHEEL_CreateUser()</code>	Creates a LISTWHEEL widget using extra bytes as user data.
<code>LISTWHEEL_GetBkColor()</code>	Returns the background color of the widget.
<code>LISTWHEEL_GetFont()</code>	Returns the font which is used to draw the data items of the given LISTWHEEL widget.
<code>LISTWHEEL_GetItemFromPos()</code>	Returns the index of the item matching the given position.
<code>LISTWHEEL_GetItemText()</code>	Returns the text of the requested data item.
<code>LISTWHEEL_GetLBorder()</code>	Returns the size in pixels between the left border of the widget and the beginning of the text.
<code>LISTWHEEL_GetLineHeight()</code>	Returns the height of one data item.
<code>LISTWHEEL_GetNumItems()</code>	Returns the number of data items of the given LISTWHEEL widget.
<code>LISTWHEEL_GetPos()</code>	Returns the zero-based index of the item which is currently snapped in.
<code>LISTWHEEL_GetRBorder()</code>	Returns the size in pixels between the right border of the widget and the end of the text.
<code>LISTWHEEL_GetSel()</code>	Returns the zero-based index of the currently selected item.
<code>LISTWHEEL_GetSnapPosition()</code>	Returns the position in pixels from the top of the LISTWHEEL widget at which the data items should be 'snapped in'.
<code>LISTWHEEL_GetTextAlign()</code>	Returns the text alignment of the given LISTWHEEL widget.
<code>LISTWHEEL_GetTextColor()</code>	Returns the text color of the widget.
<code>LISTWHEEL_GetUserData()</code>	Retrieves the data set with <code>LISTWHEEL_SetUserData()</code> .
<code>LISTWHEEL_IsMoving()</code>	Returns the current state (moving or not moving) of the given LISTWHEEL widget.
<code>LISTWHEEL_MoveToPos()</code>	Moves the data area of the LISTWHEEL widget to the given position.
<code>LISTWHEEL_OwnerDraw()</code>	Default function for managing drawing operations of one data item.
<code>LISTWHEEL_SetBkColor()</code>	Sets the specified background color for selected and unselected items.
<code>LISTWHEEL_SetDeceleration()</code>	Sets the deceleration behavior of the LISTWHEEL.
<code>LISTWHEEL_SetFont()</code>	Sets the font which should be used to draw the data items.
<code>LISTWHEEL_SetLBorder()</code>	Sets the size in pixels of the left border.

Routine	Description
<code>LISTWHEEL_SetLineHeight()</code>	Sets the line height used to draw a data item.
<code>LISTWHEEL_SetOwnerDraw()</code>	Sets an application defined owner draw function for the widget which is responsible for drawing the widget items.
<code>LISTWHEEL_SetPos()</code>	Sets the data area of the LISTWHEEL widget to the given position.
<code>LISTWHEEL_SetRBorder()</code>	Sets the size in pixels of the right border.
<code>LISTWHEEL_SetSel()</code>	The function sets the selected item.
<code>LISTWHEEL_SetSnapPosition()</code>	The function sets the relative position from the top of the widget at which the items should snap in.
<code>LISTWHEEL_SetText()</code>	It removes any existing item and adds the given items passed by the function.
<code>LISTWHEEL_SetTextAlign()</code>	Sets the text alignment used to draw the items of the LISTWHEEL widget.
<code>LISTWHEEL_SetTextColor()</code>	Sets the color to be used to draw the text.
<code>LISTWHEEL_SetTimerPeriod()</code>	Sets the time interval after which the LISTWHEEL will be updated in milliseconds.
<code>LISTWHEEL_SetUserData()</code>	Sets the extra data of a LISTWHEEL widget.
<code>LISTWHEEL_SetVelocity()</code>	Starts moving the LISTWHEEL widget using the given velocity.

## Defines

Group of defines	Description
<code>LISTWHEEL_color_indexes</code>	Color indexes used by the LISTWHEEL widget.

### 7.2.37.2.5.1 LISTWHEEL\_AddString()

#### Description

Adds a new data item (typically a string) to the widget.

#### Prototype

```
void LISTWHEEL_AddString(      LISTWHEEL_Handle  hObj,  
                             const char        * pString);
```

#### Parameters

Parameter	Description
<code>hObj</code>	Handle to a LISTVIEW widget
<code>pString</code>	Pointer to the string to be added.

#### Additional information

The width of the given text should fit into the horizontal widget area. Otherwise the text will be clipped during the drawing operation.



### 7.2.37.2.5.2 LISTWHEEL\_CreateEx()

#### Description

Creates a LISTWHEEL widget of a specified size at a specified location.

#### Prototype

```
LISTWHEEL_Handle LISTWHEEL_CreateEx(    int           x0,
                                         int           y0,
                                         int           xSize,
                                         int           ySize,
                                         WM_HWIN      hParent,
                                         int           WinFlags,
                                         int           ExFlags,
                                         int           Id,
                                         const GUI_ConstString * ppText);
```

#### Parameters

Parameter	Description
<code>x0</code>	Leftmost pixel of the widget (in parent coordinates).
<code>y0</code>	Topmost pixel of the widget (in parent coordinates).
<code>xSize</code>	Horizontal size of the widget (in pixels).
<code>ySize</code>	Vertical size of the widget (in pixels).
<code>hParent</code>	Handle of parent window. If 0, the new LISTVIEW widget will be a child of the desktop (top-level window).
<code>WinFlags</code>	Window create flags. Typically <code>WM_CF_SHOW</code> in order to make the widget visible immediately (refer to <i>Window create flags</i> on page 1146 for a list of available parameter values).
<code>ExFlags</code>	Not used, reserved for future use.
<code>Id</code>	Window ID of the widget.
<code>ppText</code>	Pointer to an array of string pointers containing the elements to be displayed.

#### Return value

Handle of the created LISTWHEEL widget; 0 if the function fails.

#### Additional information

If the parameter `ppText` is used the last element of the array needs to be a `NULL` element.

#### Example

```
char * apText[] = {
    "Monday",
    "Tuesday",
    "Wednesday",
    "Thursday",
    "Friday",
    "Saturday",
    "Sunday",
    NULL
};
LISTWHEEL_CreateEx(10, 10, 100, 100, WM_HBKWIN, WM_CF_SHOW, 0, GUI_ID_LISTWHEEL0, apText);
```

### 7.2.37.2.5.3 LISTWHEEL\_CreateIndirect()

#### Description

The prototype of this function is explained at the beginning of this chapter. Details can be found in the description of the function `<WIDGET>_CreateIndirect()` on page 1161. The element `Para` of the according `GUI_WIDGET_CREATE_INFO` structure is not used. The element `Flags` is used according to the parameter `WinFlags` of the function `LISTWHEEL_CreateEx()`.

#### 7.2.37.2.5.4 LISTWHEEL\_CreateUser()

##### Description

Prototype explained at the beginning of the chapter as `<WIDGET>_CreateUser()` on page 1162. For a detailed description of the parameters the function `LISTWHEEL_CreateEx()` can be referred to.

### 7.2.37.2.5.5 LISTWHEEL\_GetBkColor()

#### Description

Returns the background color of the widget.

#### Prototype

```
GUI_COLOR LISTWHEEL_GetBkColor(LISTWHEEL_Handle hObj,  
                                unsigned int      Index);
```

#### Parameters

Parameter	Description
<a href="#">hObj</a>	Handle of LISTWHEEL widget.
<a href="#">Index</a>	See <i>LISTWHEEL color indexes</i> on page 2741 for a full list of permitted values.

#### Return value

The background color of the given widget.

### 7.2.37.2.5.6 LISTWHEEL\_GetFont()

#### Description

Returns the font which is used to draw the data items of the given LISTWHEEL widget.

#### Prototype

```
GUI_FONT *LISTWHEEL_GetFont(LISTWHEEL_Handle hObj);
```

#### Parameters

Parameter	Description
<a href="#">hObj</a>	Handle of LISTWHEEL widget.

#### Return value

Pointer to a GUI\_FONT structure which is used to draw the data items.

### 7.2.37.2.5.7 LISTWHEEL\_GetItemFromPos()

#### Description

Returns the index of the item matching the given position.

#### Prototype

```
int LISTWHEEL_GetItemFromPos(LISTWHEEL_Handle hObj,  
                             int yPos);
```

#### Parameters

Parameter	Description
<code>hObj</code>	Handle of LISTWHEEL widget.
<code>yPos</code>	Y-position of the LISTWHEEL widget.

#### Return value

Index of the item matching the given position. -1, if an item index could not be determined.

### 7.2.37.2.5.8 LISTWHEEL\_GetItemText()

#### Description

Returns the text of the requested data item.

#### Prototype

```
void LISTWHEEL_GetItemText(LISTWHEEL_Handle hObj,  
                           unsigned Index,  
                           char * pBuffer,  
                           int MaxSize);
```

#### Parameters

Parameter	Description
<a href="#">hObj</a>	Handle of LISTWHEEL widget.
<a href="#">Index</a>	<a href="#">Index</a> of the requested item.
<a href="#">pBuffer</a>	Buffer for storing the text.
<a href="#">MaxSize</a>	Size in bytes of the buffer.

#### Return value

The function copies the text of the given item into the given buffer. If the size of the buffer is too small the text will be clipped.

### 7.2.37.2.5.9 LISTWHEEL\_GetLBorder()

#### Description

Returns the size in pixels between the left border of the widget and the beginning of the text.

#### Prototype

```
int LISTWHEEL_GetLBorder(LISTWHEEL_Handle hObj);
```

#### Parameters

Parameter	Description
<a href="#">hObj</a>	Handle of LISTWHEEL widget.

#### Return value

Number of pixels between left border and text.



### 7.2.37.2.5.10 LISTWHEEL\_GetLineHeight()

#### Description

Returns the height of one data item.

#### Prototype

```
unsigned LISTWHEEL_GetLineHeight(LISTWHEEL_Handle hObj);
```

#### Parameters

Parameter	Description
<a href="#">hObj</a>	Handle of LISTWHEEL widget.

#### Return value

Height of one data item.

#### Additional information

This function returns the value set by the function `LISTWHEEL_SetLineHeight()`. A return value of zero means the height of one item depends on the size of the current font. For more details, refer to `LISTWHEEL_SetLineHeight()`, `LISTWHEEL_GetFont()` and `GUI_GetYSize-OfFont()`.

### 7.2.37.2.5.11 LISTWHEEL\_GetNumItems()

#### Description

Returns the number of data items of the given LISTWHEEL widget.

#### Prototype

```
int LISTWHEEL_GetNumItems(LISTWHEEL_Handle hObj);
```

#### Parameters

Parameter	Description
<a href="#">hObj</a>	Handle of LISTWHEEL widget.

#### Return value

Number of data items of the given LISTWHEEL widget.

### 7.2.37.2.5.12 LISTWHEEL\_GetPos()

#### Description

Returns the zero-based index of the item which is currently snapped in.

#### Prototype

```
int LISTWHEEL_GetPos(LISTWHEEL_Handle hObj);
```

#### Parameters

Parameter	Description
<a href="#">hObj</a>	Handle of LISTWHEEL widget.

#### Return value

Index of the item which is currently snapped in.

#### Additional information

The position at which the items being snapped can be set with the function `LISTWHEEL_SetSnapPosition()`. For more details, refer to `LISTWHEEL_SetSnapPosition()`.

### 7.2.37.2.5.13 LISTWHEEL\_GetRBorder()

#### Description

Returns the size in pixels between the right border of the widget and the end of the text.

#### Prototype

```
int LISTWHEEL_GetRBorder(LISTWHEEL_Handle hObj);
```

#### Parameters

Parameter	Description
<a href="#">hObj</a>	Handle of LISTWHEEL widget.

#### Return value

Number of pixels between right border and text.

### 7.2.37.2.5.14 LISTWHEEL\_GetSel()

#### Description

Returns the zero-based index of the currently selected item.

#### Prototype

```
int LISTWHEEL_GetSel(LISTWHEEL_Handle hObj);
```

#### Parameters

Parameter	Description
<a href="#">hObj</a>	Handle of LISTWHEEL widget.

#### Return value

Index of the currently selected item.

#### Additional information

For more information, refer to `LISTWHEEL_SetSel()`.

### 7.2.37.2.5.15 LISTWHEEL\_GetSnapPosition()

#### Description

Returns the position in pixels from the top of the LISTWHEEL widget at which the data items should be 'snapped in'.

#### Prototype

```
int LISTWHEEL_GetSnapPosition(LISTWHEEL_Handle hObj);
```

#### Parameters

Parameter	Description
<a href="#">hObj</a>	Handle of LISTWHEEL widget.

#### Return value

Snap position in pixels from the top edge of the LISTWHEEL widget.

#### Additional information

The default value is 0.

### 7.2.37.2.5.16 LISTWHEEL\_GetTextAlign()

#### Description

Returns the text alignment of the given LISTWHEEL widget.

#### Prototype

```
int LISTWHEEL_GetTextAlign(LISTWHEEL_Handle hObj);
```

#### Parameters

Parameter	Description
<a href="#">hObj</a>	Handle of LISTWHEEL widget.

#### Return value

Text alignment of the given LISTWHEEL widget.

#### Additional information

For more information, refer to [LISTWHEEL\\_SetTextAlign\(\)](#).

### 7.2.37.2.5.17 LISTWHEEL\_GetTextColor()

#### Description

Returns the text color of the widget.

#### Prototype

```
GUI_COLOR LISTWHEEL_GetTextColor(LISTWHEEL_Handle hObj,  
                                unsigned int      Index);
```

#### Parameters

Parameter	Description
<a href="#">hObj</a>	Handle of LISTWHEEL widget.
<a href="#">Index</a>	See <i>LISTWHEEL color indexes</i> on page 2741 for a full list of permitted values.

#### Return value

The text color of the given widget.



### 7.2.37.2.5.18 LISTWHEEL\_GetUserData()

#### Description

Prototype explained at the beginning of the chapter as `<WIDGET>_GetUserData()` on page 1165.

### 7.2.37.2.5.19 LISTWHEEL\_IsMoving()

#### Description

Returns the current state (moving or not moving) of the given LISTWHEEL widget.

#### Prototype

```
int LISTWHEEL_IsMoving(LISTWHEEL_Handle hObj);
```

#### Parameters

Parameter	Description
<a href="#">hObj</a>	Handle of LISTWHEEL widget.
<a href="#">Index</a>	See table below.

#### Return value

0	not moving
1	moving

### 7.2.37.2.5.20 LISTWHEEL\_MoveToPos()

#### Description

Moves the data area of the LISTWHEEL widget to the given position.

#### Prototype

```
void LISTWHEEL_MoveToPos(LISTWHEEL_Handle hObj,  
                        unsigned int      Index);
```

#### Parameters

Parameter	Description
<code>hObj</code>	Handle of LISTWHEEL widget.
<code>Index</code>	Zero-based index of the item to which the 'wheel' should move.

#### Additional information

The widget starts moving by choosing the shortest way. If for example 7 items are available and item 2 is currently snapped and the widget should move to the last item it begins moving backwards until the seventh item has been reached. Detailed information on how to set a position can be found in the description of `LISTWHEEL_SetPos()`.

### 7.2.37.2.5.21 LISTWHEEL\_OwnerDraw()

#### Description

Default function for managing drawing operations of one data item.

#### Prototype

```
int LISTWHEEL_OwnerDraw(const WIDGET_ITEM_DRAW_INFO * pDrawItemInfo);
```

#### Parameters

Parameter	Description
<code>hObj</code>	Handle of LISTWHEEL widget.
<code>Index</code>	Zero-based index of the item to which the 'wheel' should move.

#### Return value

Depends on the command in the `Cmd` element of the `WIDGET_ITEM_DRAW_INFO` structure pointed by `pDrawItemInfo`.

#### Additional information

This function is useful if `LISTWHEEL_SetOwnerDraw()` is used. It can be used to retrieve the original size of a data item and/or to draw the text of a data item and should be called for all commands which are not managed by the application defined owner draw function. For more information, refer to *User drawn widgets* on page 1175, `LISTWHEEL_SetOwnerDraw()` and to the provided example.

### 7.2.37.2.5.22 LISTWHEEL\_SetBkColor()

Before	After
<div style="border: 1px solid black; padding: 5px;"> <p style="text-align: center;">Saturday</p> <p style="text-align: center;">Sunday</p> <hr style="border: 1px solid red;"/> <p style="text-align: center; color: blue;">Monday</p> <hr style="border: 1px solid red;"/> <p style="text-align: center;">Tuesday</p> <p style="text-align: center;">Wednesday</p> </div>	<div style="border: 1px solid black; padding: 5px;"> <p style="text-align: center; background-color: blue;">Saturday</p> <p style="text-align: center; background-color: blue;">Sunday</p> <hr style="border: 1px solid red;"/> <p style="text-align: center; background-color: gray; color: blue;">Monday</p> <hr style="border: 1px solid red;"/> <p style="text-align: center; background-color: blue;">Tuesday</p> <p style="text-align: center; background-color: blue;">Wednesday</p> </div>

#### Description

Sets the specified background color for selected and unselected items.

#### Prototype

```
void LISTWHEEL_SetBkColor(LISTWHEEL_Handle hObj,
                          unsigned int    Index,
                          GUI_COLOR      Color);
```

#### Parameters

Parameter	Description
<code>hObj</code>	Handle of LISTWHEEL widget.
<code>Index</code>	See <i>LISTWHEEL color indexes</i> on page 2741 for a full list of permitted values.
<code>Color</code>	New background color.

### 7.2.37.2.5.23 LISTWHEEL\_SetDeceleration()

#### Description

Sets the deceleration behavior of the LISTWHEEL. The higher the deceleration value, the less time it takes for the LISTWHEEL to stop moving.

#### Prototype

```
void LISTWHEEL_SetDeceleration(LISTWHEEL_Handle hObj,  
                               unsigned Deceleration);
```

#### Parameters

Parameter	Description
<code>hObj</code>	Handle of LISTWHEEL widget.
<code>Deceleration</code>	<code>Deceleration</code> value.

#### Additional information

The default value of the deceleration is 15. This can be change with the configuration option LISTWHEEL\_DECELERATION\_DEFAULT.

### 7.2.37.2.5.24 LISTWHEEL\_SetFont()

Before	After
<div style="border: 1px solid black; padding: 5px;">           Friday            Saturday  <hr style="border: 1px solid red;"/>           Sunday  <hr style="border: 1px solid red;"/>           Monday            Tuesday         </div>	<div style="border: 1px solid black; padding: 5px;"> <b>Friday</b>  <b>Saturday</b>  <hr style="border: 1px solid red;"/> <b>Sunday</b>  <hr style="border: 1px solid red;"/> <b>Monday</b>  <b>Tuesday</b> </div>

#### Description

Sets the font which should be used to draw the data items.

#### Prototype

```
void LISTWHEEL_SetFont(      LISTWHEEL_Handle  hObj,
                           const GUI_FONT      * pFont);
```

#### Parameters

Parameter	Description
<code>hObj</code>	Handle of LISTWHEEL widget.
<code>pFont</code>	Pointer to a GUI_FONT structure.

### 7.2.37.2.5.25 LISTWHEEL\_SetLBorder()

Before	After
<div style="border: 1px solid black; padding: 5px;"> <p>Friday</p> <p>Saturday</p> <hr style="border: 1px solid red;"/> <p>Sunday</p> <hr style="border: 1px solid red;"/> <p>Monday</p> <p>Tuesday</p> </div>	<div style="border: 1px solid black; padding: 5px;"> <p>Friday</p> <p>Saturday</p> <hr style="border: 1px solid red;"/> <p>Sunday</p> <hr style="border: 1px solid red;"/> <p>Monday</p> <p>Tuesday</p> </div>

#### Description

Sets the border size between the left edge of the widget and the beginning of the text.

#### Prototype

```
void LISTWHEEL_SetLBorder(LISTWHEEL_Handle hObj,
                        unsigned BorderSize);
```

#### Parameters



Parameter	Description
<code>hObj</code>	Handle of LISTWHEEL widget.
<code>BorderSize</code>	Desired border size.

#### Additional information

The default value of the border size is 0.



### 7.2.37.2.5.26 LISTWHEEL\_SetLineHeight()

Before	After
	

#### Description

Sets the line height used to draw a data item.

#### Prototype

```
void LISTWHEEL_SetLineHeight(LISTWHEEL_Handle hObj,
                             unsigned LineHeight);
```

#### Parameters

Parameter	Description
<code>hObj</code>	Handle of LISTWHEEL widget.
<code>LineHeight</code>	Desired height. Default is 0 which means the font size determines the height of a line.

#### Additional information

Per default the height of a line depends on the used font. The value set by this function 'overwrites' this default behavior.

### 7.2.37.2.5.27 LISTWHEEL\_SetOwnerDraw()

Before	After
<div style="border: 1px solid black; padding: 5px; width: fit-content; margin: auto;">           Friday            Saturday            Sunday  <b>Monday</b>            Tuesday         </div>	<div style="border: 1px solid black; padding: 5px; width: fit-content; margin: auto;">           Friday            Saturday  <hr style="border: 1px solid red;"/>           Sunday  <hr style="border: 1px solid red;"/> <b>Monday</b>            Tuesday         </div>

#### Description

Sets an application defined owner draw function for the widget which is responsible for drawing the widget items.

#### Prototype

```
void LISTWHEEL_SetOwnerDraw(LISTWHEEL_Handle hObj,
                           WIDGET_DRAW_ITEM_FUNC * pfOwnerDraw);
```

#### Parameters

Parameter	Description
<code>hObj</code>	Handle of LISTWHEEL widget.
<code>pfOwnerDraw</code>	Pointer to owner draw function.

#### Supported commands

- WIDGET\_ITEM\_GET\_XSIZE
- WIDGET\_ITEM\_GET\_YSIZE
- WIDGET\_ITEM\_DRAW
- WIDGET\_ITEM\_DRAW\_BACKGROUND
- WIDGET\_ITEM\_DRAW\_OVERLAY

#### Additional information

This function sets a pointer to an application defined function which will be called by the widget when a data item has to be drawn or when the x or y size of a item is needed. It gives you the possibility to draw anything as data item, not just plain text. `pfDrawItem` is a pointer to an application-defined function of type `WIDGET_DRAW_ITEM_FUNC` which is explained at the beginning of the chapter.

The following commands are supported: `WIDGET_ITEM_GET_YSIZE`, `WIDGET_ITEM_DRAW`, `WIDGET_DRAW_BACKGROUND` and `WIDGET_DRAW_OVERLAY`.

#### Example

The following example routine draws 2 red indicator lines over the widget:

```
static int _OwnerDraw(const WIDGET_DRAW_ITEM_FUNC * pDrawItemInfo) {
    switch (pDrawItemInfo->Cmd) {
        case WIDGET_DRAW_OVERLAY:
            GUI_SetColor(GUI_RED);
            GUI_DrawHLine(40, 0, 99);
            GUI_DrawHLine(59, 0, 99);
            break;
        default:
            return LISTWHEEL_OwnerDraw(pDrawItemInfo);
    }
    return 0;
}
```

### 7.2.37.2.5.28 LISTWHEEL\_SetPos()

#### Description

Sets the data area of the LISTWHEEL widget to the given position.

#### Prototype

```
void LISTWHEEL_SetPos(LISTWHEEL_Handle hObj,  
                     unsigned Index);
```

#### Parameters

Parameter	Description
<a href="#">hObj</a>	Handle of LISTWHEEL widget.
<a href="#">Index</a>	Zero-based index of the item to which the 'wheel' should be set.

#### Additional information

Detailed information on how to move the LISTWHEEL to a position can be found in the description of `LISTWHEEL_MoveToPos()`.

### 7.2.37.2.5.29 LISTWHEEL\_SetRBorder()

Before	After
<div style="border: 1px solid black; padding: 5px;"> <p>Friday</p> <p>Saturday</p> <hr style="border: 1px solid red;"/> <p>Sunday</p> <hr style="border: 1px solid red;"/> <p>Monday</p> <p>Tuesday</p> </div>	<div style="border: 1px solid black; padding: 5px;"> <p>Friday</p> <p>Saturday</p> <hr style="border: 1px solid red;"/> <p>Sunday</p> <hr style="border: 1px solid red;"/> <p>Monday</p> <p>Tuesday</p> </div>

#### Description

Sets the border size between the left edge of the widget and the beginning of the text.

#### Prototype

```
void LISTWHEEL_SetRBorder(LISTWHEEL_Handle hObj,
                          unsigned        BorderSize);
```

#### Parameters

Parameter	Description
<code>hObj</code>	Handle of LISTWHEEL widget.
<code>BorderSize</code>	Desired border size.

#### Additional information

The default value of the border size is 0.

### 7.2.37.2.5.30 LISTWHEEL\_SetSel()

Before	After
<div style="border: 1px solid black; padding: 5px;">           Friday            Saturday  <hr style="border: 1px solid red;"/>           Sunday  <hr style="border: 1px solid red;"/> <b>Monday</b>            Tuesday         </div>	<div style="border: 1px solid black; padding: 5px;">           Friday            Saturday  <hr style="border: 1px solid red;"/>           Sunday  <hr style="border: 1px solid red;"/> <b>Monday</b>  <b>Tuesday</b> </div>

#### Description

The function sets the selected item.

#### Prototype

```
void LISTWHEEL_SetSel(LISTWHEEL_Handle hObj,
                     int Sel);
```

#### Parameters

Parameter	Description
<code>hObj</code>	Handle of LISTWHEEL widget.
<code>Sel</code>	Zero-based index of item to be selected.

#### Additional information

Only one item can be selected. Per default the item with index 0 is selected.

### 7.2.37.2.5.31 LISTWHEEL\_SetSnapPosition()

Before	After
<div style="border: 1px solid black; padding: 5px;"> <p><b>Monday</b></p> <p><b>Tuesday</b></p> <p><b>Wednesday</b></p> <p><b>Thursday</b></p> <p><b>Friday</b></p> </div>	<div style="border: 1px solid black; padding: 5px;"> <p><b>Saturday</b></p> <p><b>Sunday</b></p> <p><b>Monday</b></p> <p><b>Tuesday</b></p> <p><b>Wednesday</b></p> </div>

#### Description

The function sets the relative position from the top of the widget at which the items should snap in.

#### Prototype

```
void LISTWHEEL_SetSnapPosition(LISTWHEEL_Handle hObj,
                               int SnapPosition);
```

#### Parameters

Parameter	Description
<code>hObj</code>	Handle of LISTWHEEL widget.
<code>SnapPosition</code>	Relative position in pixels from the top of the widget at which the items should be snapped in.

#### Additional information

Per default the snap position is 0 which means the items are snapped in at the top of the widget. The function `LISTWHEEL_GetPos()` can be used to get the zero based index of the current item which has been snapped in.

### 7.2.37.2.5.32 LISTWHEEL\_SetText()

Before	After
<div style="border: 1px solid black; padding: 5px; text-align: center;">           Friday            Saturday  <hr style="border: 1px solid red;"/>           Sunday  <hr style="border: 1px solid red;"/>           Monday            Tuesday         </div>	<div style="border: 1px solid black; padding: 5px; text-align: center;">           November            December  <hr style="border: 1px solid red;"/>           January  <hr style="border: 1px solid red;"/>           February            March         </div>

#### Description

It removes any existing item and adds the given items passed by the function.

#### Prototype

```
void LISTWHEEL_SetText(      LISTWHEEL_Handle  hObj,
                          const GUI_ConstString * ppText);
```

#### Parameters

Parameter	Description
<code>hObj</code>	Handle of LISTWHEEL widget.
<code>ppText</code>	Pointer to an array of strings. The last item needs to be a NULL pointer.

#### Additional information

Note that the last element pointed to by `ppText` needs to be a NULL pointer.

#### Example

The following example should demonstrate how the function should be used:

```
static char * _apText[] = {
    "Monday",
    "Tuesday",
    "Wednesday",
    "Thursday",
    "Friday",
    "Saturday",
    "Sunday",
    NULL
};
static void _SetContent(void) {
    LISTWHEEL_SetText(hWin, _apText);
}
```

### 7.2.37.2.5.33 LISTWHEEL\_SetTextAlign()

Before	After
<div style="border: 1px solid black; padding: 5px;"> <p>Friday</p> <p>Saturday</p> <hr style="border: 1px solid red;"/> <p>Sunday</p> <hr style="border: 1px solid red;"/> <p>Monday</p> <p>Tuesday</p> </div>	<div style="border: 1px solid black; padding: 5px;"> <p>Saturday</p> <p>Sunday</p> <hr style="border: 1px solid red;"/> <p>Monday</p> <hr style="border: 1px solid red;"/> <p>Tuesday</p> <p>Wednesday</p> </div>

#### Description

Sets the text alignment used to draw the items of the LISTWHEEL widget.

#### Prototype

```
void LISTWHEEL_SetTextAlign(LISTWHEEL_Handle hObj,
                           int Align);
```

#### Parameters

Parameter	Description
<code>hObj</code>	Handle of LISTWHEEL widget.
<code>Align</code>	Alignment to be used to draw the items of the widget.

#### Additional information

For details about text alignment, refer to `GUI_SetTextAlign()`.



## 7.2.37.2.5.34 LISTWHEEL\_SetTextColor()

Before	After
<div style="border: 1px solid black; padding: 5px;"> <p>Friday</p> <p>Saturday</p> <hr style="border: 1px solid red;"/> <p>Sunday</p> <hr style="border: 1px solid red;"/> <p>Monday</p> <p>Tuesday</p> </div>	<div style="border: 1px solid black; padding: 5px;"> <p>Saturday</p> <p>Sunday</p> <hr style="border: 1px solid red;"/> <p>Monday</p> <hr style="border: 1px solid red;"/> <p>Tuesday</p> <p>Wednesday</p> </div>

**Description**

Sets the color to be used to draw the text.

**Prototype**

```
void LISTWHEEL_SetTextColor(LISTWHEEL_Handle hObj,
                           unsigned int      Index,
                           GUI_COLOR         Color);
```

**Parameters**

Parameter	Description
<code>hObj</code>	Handle of LISTWHEEL widget.
<code>Index</code>	See table below. See <i>LISTWHEEL color indexes</i> on page 2741 for a full list of permitted values.
<code>Color</code>	<code>Color</code> to be used.

### 7.2.37.2.5.35 LISTWHEEL\_SetTimerPeriod()

#### Description

Sets the time interval after which the LISTWHEEL will be updated in milliseconds. By default this will be every 25ms.

#### Prototype

```
void LISTWHEEL_SetTimerPeriod(LISTWHEEL_Handle hObj,  
                             GUI_TIMER_TIME   TimerPeriod);
```

#### Parameters

Parameter	Description
<code>hObj</code>	Handle of LISTWHEEL widget.
<code>TimerPeriod</code>	Timer period used for updating the LISTWHEEL.

#### Additional information

The default value of 25 can be set with the configuration option `LISTWHEEL_TIMER_PERIOD`.

### 7.2.37.2.5.36 LISTWHEEL\_SetUserData()

#### Description

Prototype explained at the beginning of the chapter as `<WIDGET>_SetUserData()` on page 1166.

### 7.2.37.2.5.37 LISTWHEEL\_SetVelocity()

#### Description

Starts moving the LISTWHEEL widget using the given velocity.

#### Prototype

```
void LISTWHEEL_SetVelocity(LISTWHEEL_Handle hObj,  
                           int Velocity);
```

#### Parameters

Parameter	Description
<code>hObj</code>	Handle of LISTWHEEL widget.
<code>Velocity</code>	Starting speed.

#### Additional information

The velocity decreases automatically. The higher the given velocity the longer it takes for the movement to stop.

#### Example

This function is used in the sample applications `MEMDEV_ListWheelEffects.c` and `WIDGET_ListWheel.c`.

### 7.2.37.2.5.38 LISTWHEEL color indexes

#### Description

Color indexes to be used by the LISTWHEEL widget.

#### Definition

```
#define LISTWHEEL_CI_UNSEL 0
#define LISTWHEEL_CI_SEL 1
```

#### Symbols

Definition	Description
<a href="#">LISTWHEEL_CI_UNSEL</a>	Color of unselected element.
<a href="#">LISTWHEEL_CI_SEL</a>	Color of selected element.

## 7.3 Dialogs

Widgets may be created and used on their own, as they are by nature windows themselves. However, it is often desirable to use dialog boxes, which are windows that contain one or more widgets.

A dialog box (or dialog) is normally a window that appears in order to request input from the user. It may contain multiple widgets, requesting information from the user through various selections, or it may take the form of a message box which simply provides information (such as a note or warning) and an "OK" button.

For common tasks like choosing a file, choosing a color or (as mentioned before) for showing simple text messages emWin offers 'common dialogs'. These dialogs can be configured to achieve the look and feel of the application.

### 7.3.1 Dialog basics

#### Input focus

The Window Manager remembers the window or window object that was last selected by the user with the touch-screen, mouse, keyboard, or other means. This window receives keyboard input messages and is said to have the input focus.

The primary reason for keeping track of input focus is to determine where to send keyboard commands. The window which has input focus will receive events generated by the keyboard.

To move the input focus within a dialog to the next focusable dialog item the key `GUI_KEY_TAB` can be used. To move backwards `GUI_KEY_BACKTAB` can be used.

#### Blocking vs. non-blocking dialogs

Dialog windows can be blocking or non-blocking.

A blocking dialog blocks the thread of execution. It has input focus by default and must be closed by the user before the thread can continue. A blocking dialog does not disable other dialogs shown at the same time. With other words a blocking dialog is not a modal dialog. Blocking means, the used functions (`GUI_ExecDialogBox()` or `GUI_ExecCreatedDialog()`) does not return until the dialog is closed.

A non-blocking dialog, on the other hand, does not block the calling thread—it allows the task to continue while it is visible. The function returns immediately after creating the dialog.

Blocking functions should never be called from within a callback function. This may cause malfunction of the application.

#### Dialog procedure

A dialog box is a window, and it receives messages just as every other window in the system does. Most messages are handled automatically by the client callback routine of the dialog box. The others are passed to the client callback routine which is specified as a parameter upon creation. The client callback function is known as the dialog procedure.

Since a dialog itself usually consists of 2 windows (dialog and client window), messages have to be sent using the correct handle. After a dialog was created there is only one handle to the dialog. In order to access the client window, the function `WM_GetClientWindow()` should be used.

#### Dialog messages

There are two types of additional messages which are sent to the dialog procedure: `WM_INIT_DIALOG` and `WM_NOTIFY_PARENT`. The `WM_INIT_DIALOG` message is sent to the dialog procedure immediately before a dialog box is displayed. Dialog procedures typically use this message to initialize widgets and carry out any other initialization tasks that affect the appearance of the dialog box. The `WM_NOTIFY_PARENT` message is sent to the dialog box by its child windows in order to notify the parent of any events in order to ensure syn-

chronization. The events sent by a child depend on its type and are documented separately for every type of widget.

## 7.3.2 Creating a dialog

Two basic things are required to create a dialog box: a resource table that defines the widgets to be included, and a dialog procedure which defines the initial values for the widgets as well as their behavior. Once both items exist, you need only a single function call (`GUI_CreateDialogBox()` or `GUI_ExecDialogBox()`) to actually create the dialog.

### 7.3.2.1 Resource table

Dialog boxes may be created in a blocking manner (using `GUI_ExecDialogBox()`) or as non-blocking (using `GUI_CreateDialogBox()`). A resource table must first be defined which specifies all widgets to be included in the dialog. The example shown below creates a resource table:

```
static const GUI_WIDGET_CREATE_INFO _aDialogCreate[] = {
  { FRAMEWIN_CreateIndirect, "Dialog", 0, 10, 10, 180, 230, 0, 0 },
  { BUTTON_CreateIndirect, "OK", GUI_ID_OK, 100, 5, 60, 20, 0, 0 },
  { BUTTON_CreateIndirect, "Cancel", GUI_ID_CANCEL, 100, 30, 60, 20, 0, 0 },
  { TEXT_CreateIndirect, "LText", 0, 10, 55, 48, 15, TEXT_CF_LEFT, 0 },
  { TEXT_CreateIndirect, "RText", 0, 10, 80, 48, 15, TEXT_CF_RIGHT, 0 },
  { EDIT_CreateIndirect, NULL, GUI_ID_EDIT0, 60, 55, 100, 15, 0, 50 },
  { EDIT_CreateIndirect, NULL, GUI_ID_EDIT1, 60, 80, 100, 15, 0, 50 },
  { TEXT_CreateIndirect, "Hex", 0, 10, 100, 48, 15, TEXT_CF_RIGHT, 0 },
  { EDIT_CreateIndirect, NULL, GUI_ID_EDIT2, 60, 100, 100, 15, 0, 6 },
  { TEXT_CreateIndirect, "Bin", 0, 10, 120, 48, 15, TEXT_CF_RIGHT, 0 },
  { EDIT_CreateIndirect, NULL, GUI_ID_EDIT3, 60, 120, 100, 15, 0, 0 },
  { LISTBOX_CreateIndirect, NULL, GUI_ID_LISTBOX0, 10, 10, 48, 40, 0, 0 },
  { CHECKBOX_CreateIndirect, NULL, GUI_ID_CHECK0, 10, 140, 0, 0, 0, 0 },
  { CHECKBOX_CreateIndirect, NULL, GUI_ID_CHECK1, 30, 140, 0, 0, 0, 0 },
  { SLIDER_CreateIndirect, NULL, GUI_ID_SLIDER0, 60, 140, 100, 20, 0, 0 },
  { SLIDER_CreateIndirect, NULL, GUI_ID_SLIDER1, 10, 170, 150, 30, 0, 0 }
};
```

Widgets can be included in a dialog by using the `<WIDGET>_CreateIndirect()` function for indirect creation. Detailed information can be found in the chapter *Widgets (window objects)* on page 1151

### 7.3.2.2 Dialog procedure

The example above has been created using the blank dialog procedure shown below. This is the basic template which should be used as a starting point when creating any dialog procedure:

```
/*
 *
 *   Dialog procedure
 */
static void _cbCallback(WM_MESSAGE * pMsg) {
  switch (pMsg->MsgId) {
  default:
    WM_DefaultProc(pMsg);
  }
}
```

For this example, the dialog box is displayed with the following line of code:

```
GUI_ExecDialogBox(_aDialogCreate, GUI_COUNTOF(_aDialogCreate),
  _cbCallback, 0, 0, 0);
```

The resulting dialog box looks as follows, or similar (the actual appearance will depend on your configuration and default settings):

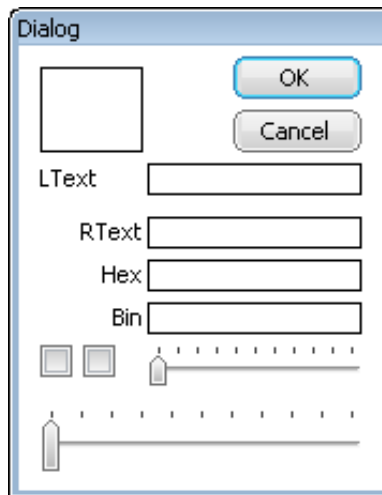

After creation of the dialog box, all widgets included in the resource table will be visible, although as can be seen in the previous screenshot, they will appear “empty”. This is because the dialog procedure does not yet contain code that initializes the individual elements. The initial values of the widgets, the actions caused by them, and the interactions between them need to be defined in the dialog procedure.

### 7.3.2.1 Initializing the dialog

The typical next step is to initialize the widgets with their respective initial values. This is normally done in the dialog procedure as a reaction to the `WM_INIT_DIALOG` message. The program excerpt below illustrates things:

```

/*****
 *
 *   Dialog procedure
 */
static void _cbCallback(WM_MESSAGE * pMsg) {
    WM_HWIN hItem;
    WM_HWIN hWin;
    hWin = pMsg->hWin;
    switch (pMsg->MsgId) {
    case WM_INIT_DIALOG:
        hItem = WM_GetDialogItem(hWin, GUI_ID_EDIT0);
        EDIT_SetText(hItem, "EDIT widget 0");
        hItem = WM_GetDialogItem(hWin, GUI_ID_EDIT1);
        EDIT_SetText(hItem, "EDIT widget 1");
        EDIT_SetTextAlign(hItem, GUI_TA_LEFT);
        hItem = WM_GetDialogItem(hWin, GUI_ID_EDIT2);
        EDIT_SetHexMode(hItem, 0x1234, 0, 0xffff);
        hItem = WM_GetDialogItem(hWin, GUI_ID_EDIT3);
        EDIT_SetBinMode(hItem, 0x1234, 0, 0xffff);
        hItem = WM_GetDialogItem(hWin, GUI_ID_CHECK0);
        CHECKBOX_Check(WM_GetDialogItem(hWin, GUI_ID_CHECK0));
        hItem = WM_GetDialogItem(hWin, GUI_ID_CHECK1);
        WM_DisableWindow(WM_GetDialogItem(hWin, GUI_ID_CHECK1));
        CHECKBOX_Check(WM_GetDialogItem(hWin, GUI_ID_CHECK1));
        hItem = WM_GetDialogItem(hWin, GUI_ID_SLIDER0);
        SLIDER_SetWidth(WM_GetDialogItem(hWin, GUI_ID_SLIDER0), 5);
        hItem = WM_GetDialogItem(hWin, GUI_ID_SLIDER1);
        SLIDER_SetValue(WM_GetDialogItem(hWin, GUI_ID_SLIDER1), 50);
        hItem = WM_GetDialogItem(hWin, GUI_ID_LISTBOX0);
        LISTBOX_SetText(hItem, _apListBox);
        break;
    default:
        WM_DefaultProc(pMsg);
    }
}

```



The initialized dialog box now appears as follows, with all widgets containing their initial values:

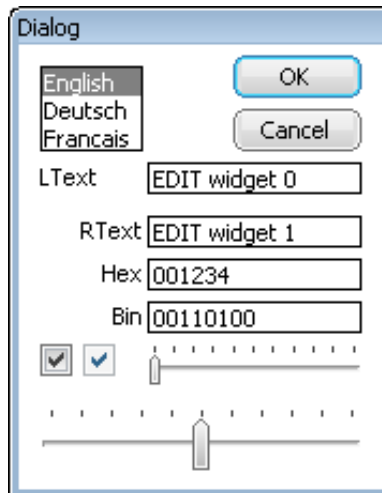

### 7.3.2.3 Defining dialog behavior

Once the dialog has been initialized, all that remains is to add code to the dialog procedure which will define the behavior of the widgets, making them fully operable. Continuing with the same example, the final dialog procedure is shown below:

```

/*****
 *
 *   Dialog procedure
 */
static void _cbCallback(WM_MESSAGE * pMsg) {
    WM_HWIN hEdit0, hEdit1, hEdit2, hEdit3;
    WM_HWIN hListBox;
    WM_HWIN hWin
    int   NCode
    int   Id;
    hWin = pMsg->hWin;
    switch (pMsg->MsgId) {
    case WM_INIT_DIALOG:
        /* Get window handles for all widgets */
        hEdit0 = WM_GetDialogItem(hWin, GUI_ID_EDIT0);
        hEdit1 = WM_GetDialogItem(hWin, GUI_ID_EDIT1);
        hEdit2 = WM_GetDialogItem(hWin, GUI_ID_EDIT2);
        hEdit3 = WM_GetDialogItem(hWin, GUI_ID_EDIT3);
        hListBox = WM_GetDialogItem(hWin, GUI_ID_LISTBOX0);
        /* Initialize all widgets */
        EDIT_SetText(hEdit0, "EDIT widget 0");
        EDIT_SetText(hEdit1, "EDIT widget 1");
        EDIT_SetTextAlign(hEdit1, GUI_TA_LEFT);
        EDIT_SetHexMode(hEdit2, 0x1234, 0, 0xffff);
        EDIT_SetBinMode(hEdit3, 0x1234, 0, 0xffff);
        LISTBOX_SetText(hListBox, _apListBox);
        WM_DisableWindow(WM_GetDialogItem(hWin, GUI_ID_CHECK1));
        CHECKBOX_Check( WM_GetDialogItem(hWin, GUI_ID_CHECK0));
        CHECKBOX_Check( WM_GetDialogItem(hWin, GUI_ID_CHECK1));
        SLIDER_SetWidth( WM_GetDialogItem(hWin, GUI_ID_SLIDER0), 5);
        SLIDER_SetValue( WM_GetDialogItem(hWin, GUI_ID_SLIDER1), 50);
        break;
    case WM_KEY:
        switch (((WM_KEY_INFO*)(pMsg->Data.p))>Key) {
        case GUI_ID_ESCAPE:
            GUI_EndDialog(hWin, 1);
            break;
        case GUI_ID_ENTER:
            GUI_EndDialog(hWin, 0);
            break;

```

```

    }
    break;
case WM_NOTIFY_PARENT:
    Id = WM_GetId(pMsg->hWinSrc);      /* Id of widget          */
    NCode = pMsg->Data.v;              /* Notification code     */
    switch (NCode) {
    case WM_NOTIFICATION_RELEASED:    /* React only if released */
        if (Id == GUI_ID_OK) {       /* OK Button             */
            GUI_EndDialog(hWin, 0);
        }
        if (Id == GUI_ID_CANCEL) {   /* Cancel Button         */
            GUI_EndDialog(hWin, 1);
        }
        break;
    case WM_NOTIFICATION_SEL_CHANGED: /* Selection changed     */
        FRAMEWIN_SetText(hWin, "Dialog - sel changed");
        break;
    default:
        FRAMEWIN_SetText(hWin, "Dialog - notification received");
    }
    break;
default:
    WM_DefaultProc(pMsg);
}
}
}

```

### 7.3.3 Dialog API

The table below lists the available dialog-related routines in alphabetical. Detailed descriptions follow:

Routine	Description
<a href="#">GUI_CreateDialogBox()</a>	Creates a dialog box.
<a href="#">GUI_ExecCreatedDialog()</a>	Executes an already created dialog box.
<a href="#">GUI_ExecDialogBox()</a>	Creates and executes a dialog box.
<a href="#">GUI_EndDialog()</a>	Ends (closes) a dialog box.

### 7.3.3.1 GUI\_CreateDialogBox()

#### Description

Creates a dialog box.

#### Prototype

```
WM_HWIN GUI_CreateDialogBox(const GUI_WIDGET_CREATE_INFO * paWidget,
                             int NumWidgets,
                             WM_CALLBACK * cb,
                             WM_HWIN hParent,
                             int x0,
                             int y0);
```

#### Parameters

Parameter	Description
<code>paWidget</code>	Pointer to resource table defining the widgets to be included in the dialog.
<code>NumWidgets</code>	Total number of widgets included in the dialog.
<code>cb</code>	Pointer to an application-specific callback function (dialog procedure).
<code>hParent</code>	Handle of parent window (0 = no parent window).
<code>x0</code>	X-position of the dialog relative to parent window.
<code>y0</code>	Y-position of the dialog relative to parent window.

#### Return value

Handle of the created dialog. This handle can be used to access the first widget from the resource table. This should be a FRAMEWIN or WINDOW widget.

#### Additional information

The parameter `cb` is used as callback function for the client window. If a callback function should be set for the dialog window, the function `WM_SetCallback()` should be used with the handle returned by `GUI_CreateDialogBox()`. The handle of the client window can be determined using the function `WM_GetClientWindow()` passing the handle of the dialog which was returned by `GUI_CreateDialogBox()`.

### 7.3.3.2 GUI\_ExecCreatedDialog()

#### Description

Executes an already created dialog box.

#### Prototype

```
int GUI_ExecCreatedDialog(WM_HWIN hDialog);
```

#### Parameters

Parameter	Description
<code>hDialog</code>	Handle to dialog box.

#### Return value

Return value which was passed to `GUI_EndDialog()`.

#### Additional information

This is a blocking function. It does not return until the dialog is closed using the function `GUI_EndDialog()`. The `WM_CF_SHOW` flag is set, so the dialog is drawn the next time the Window Manager is executed.

### 7.3.3.3 GUI\_ExecDialogBox()

#### Description

Creates and executes a dialog box.

#### Prototype

```
int GUI_ExecDialogBox(const GUI_WIDGET_CREATE_INFO * paWidget,
                    int NumWidgets,
                    WM_CALLBACK * cb,
                    WM_HWIN hParent,
                    int x0,
                    int y0);
```

#### Parameters

Parameter	Description
<code>paWidget</code>	Pointer to a resource table defining the widgets to be included in the dialog.
<code>NumWidgets</code>	Total number of widgets included in the dialog.
<code>cb</code>	Pointer to an application-specific callback function (dialog procedure).
<code>hParent</code>	Handle of parent window (0 = no parent window).
<code>x0</code>	X-position of the dialog relative to parent window.
<code>y0</code>	Y-position of the dialog relative to parent window.

#### Return value

Return value which was passed to `GUI_EndDialog()`.

#### Additional information

This function actually calls `GUI_CreateDialogBox()` and `GUI_ExecCreatedDialog()`. It is blocking and therefore does not return until the dialog is closed using the function `GUI_EndDialog()`. The `WM_CF_SHOW` flag is set, so the dialog is drawn the next time the Window Manager is executed.

### 7.3.3.4 GUI\_EndDialog()

#### Description

Ends (closes) a dialog box. The dialog and its child windows will be removed from memory.

#### Prototype

```
void GUI_EndDialog(WM_HWIN hDialog,  
                  int r);
```

#### Parameters

Parameter	Description
<code>hDialog</code>	Handle to dialog box.
<code>r</code>	Value which is returned by the function <code>GUI_ExecDialog-Box()</code> . This value is ignored in case a non-blocking dialog is closed.

#### Additional information

After the next call of `WM_Exec()` (gets also called in `GUI_Delay()`) the handle `hDialog` is no longer valid. Please note, that a `WM_DELETE` will be send delayed to the closed dialog.

## 7.3.4 CALENDAR dialog

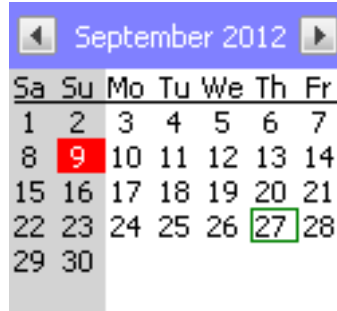

The CALENDAR dialog can be used for selecting or setting a date. The dialog consists of 2 buttons for month wise scrolling, a text which shows the current year and month and a pad of days. A small surrounding frame is shown surrounding the current date and the current selection is highlighted. The keyboard and/or the pointer input device (PID) can be used for selecting a date. The dialog supports the Gregorian calendar which is used since 1582.

The buttons to the left and right of month and year can be modified by using the IDs of the BUTTON widgets.

The left button uses the ID `GUI_ID_BUTTON0` and right one `GUI_ID_BUTTON1`. By calling the function `WM_GetDialogItem()` with the proper ID it is possible to receive the BUTTON handle and manage the buttons as any other BUTTON widget.

### 7.3.4.1 Notification codes

The following events are sent from the dialog to its parent window as part of a `WM_NOTIFY_PARENT` message:

Message	Description
<code>CALENDAR_NOTIFICATION_MONTH_CLICKED</code>	Month/year-text has been clicked.
<code>CALENDAR_NOTIFICATION_MONTH_RELEASED</code>	Month/year-text has been released.
<code>WM_NOTIFICATION_CLICKED</code>	Widget has been clicked.
<code>WM_NOTIFICATION_RELEASED</code>	Widget has been released.
<code>WM_NOTIFICATION_SCROLL_CHANGED</code>	One of the scroll buttons has been pressed.
<code>WM_NOTIFICATION_SEL_CHANGED</code>	The selection has been changed.

### 7.3.4.2 Keyboard reaction

Key	Reaction
<code>GUI_KEY_PGUP</code>	Selection moves one month back.
<code>GUI_KEY_PGDOWN</code>	Selection moves one month forward.
<code>GUI_KEY_LEFT</code>	Selection moves to the left.
<code>GUI_KEY_RIGHT</code>	Selection moves to the right.
<code>GUI_KEY_UP</code>	Selection moves one line up.
<code>GUI_KEY_DOWN</code>	Selection moves one line down.

### 7.3.4.3 CALENDAR\_API

The table below lists the available CALENDAR-related routines in alphabetical order. Detailed descriptions follow.

#### Functions

Routine	Description
<a href="#">CALENDAR_AddKey()</a>	Adds user input to a specified CALENDAR dialog.
<a href="#">CALENDAR_Create()</a>	Creates a CALENDAR dialog.
<a href="#">CALENDAR_GetDate()</a>	Returns the current date.
<a href="#">CALENDAR_GetDaysOfMonth()</a>	Returns the number of days in a specific month.
<a href="#">CALENDAR_GetSel()</a>	Returns the currently selected date.
<a href="#">CALENDAR_GetWeekday()</a>	Returns the number of the weekday of a given date.
<a href="#">CALENDAR_SetDate()</a>	Sets the current date.
<a href="#">CALENDAR_SetSel()</a>	Sets the currently selected date.
<a href="#">CALENDAR_SetDefaultBkColor()</a>	Sets the default background color to be used for new CALENDAR dialogs.
<a href="#">CALENDAR_SetDefaultColor()</a>	Sets the default color to be used for new CALENDAR dialogs.
<a href="#">CALENDAR_SetDefaultDays()</a>	Sets the text to be used to label the days.
<a href="#">CALENDAR_SetDefaultFont()</a>	Sets the font(s) to be used for drawing the CALENDAR items.
<a href="#">CALENDAR_SetDefaultMonths()</a>	Sets the text to be used for the current month / year.
<a href="#">CALENDAR_SetDefaultSize()</a>	Sets the sizes to be used by the dialog.
<a href="#">CALENDAR_ShowDate()</a>	Shows a given date on the calendar.

#### Data structures

Structure	Description
<a href="#">CALENDAR_DATE</a>	Structure used by the routine <a href="#">CALENDAR_GetDate()</a> to retrieve a date.

#### Defines

Group of defines	Description
<a href="#">CALENDAR color indexes</a>	Color indexes used by the CALENDAR dialog.
<a href="#">CALENDAR font indexes</a>	Font indexes used by the CALENDAR dialog.
<a href="#">CALENDAR size indexes</a>	Size indexes used by the routine <a href="#">CALENDAR_SetDefaultSize()</a> .



### 7.3.4.3.1 Functions

#### 7.3.4.3.1.1 CALENDAR\_AddKey()

##### Description

Adds user input to a specified CALENDAR dialog.

##### Prototype

```
int CALENDAR_AddKey(WM_HWIN hWin,  
                    int      Key);
```

##### Parameters

Parameter	Description
<a href="#">hWin</a>	Handle of CALENDAR handle.
<a href="#">Key</a>	Character to be added.

### 7.3.4.3.1.2 CALENDAR\_Create()

#### Description

Creates a CALENDAR dialog.

#### Prototype

```
WM_HWIN CALENDAR_Create(WM_HWIN hParent,
                        int xPos,
                        int yPos,
                        unsigned Year,
                        unsigned Month,
                        unsigned Day,
                        unsigned FirstDayOfWeek,
                        int Id,
                        int Flags);
```

#### Parameters

Parameter	Description
<code>hParent</code>	Handle of the parent window which should receive the notification messages.
<code>xPos</code>	X position in pixels of the dialog in client coordinates.
<code>yPos</code>	Y position in pixels of the dialog in client coordinates.
<code>Year</code>	Current year (1582-9999).
<code>Month</code>	Current month (1-12).
<code>Day</code>	Current day (1-31).
<code>FirstDayOfWeek</code>	First weekday to be used (0=Saturday, 1=Sunday, ... , 6=Friday).
<code>Id</code>	<code>Id</code> to be used for the CALENDAR dialog.
<code>Flags</code>	Additional flags for the WINDOW widget.

#### Return value

Handle of the dialog on success, otherwise 0.

#### Additional information

`Year`, `Month` and `Day` specify the current date. Per default this is also the initial selection. `FirstDayOfWeek` determines an offset for the first day to be shown. Default is showing Saturday at first.

### 7.3.4.3.1.3 CALENDAR\_GetDate()

#### Description

Returns the current date.

#### Prototype

```
void CALENDAR_GetDate(WM_HWIN hWin,  
                     CALENDAR_DATE * pDate);
```

#### Parameters

Parameter	Description
<code>hWin</code>	Handle of CALENDAR dialog.
<code>pDate</code>	Pointer to a CALENDAR_DATE structure.

#### Additional information

Current date and selected date are different items. The selection can be moved by the keyboard interface and/or the PID whereas the current date can be specified when creating the dialog or by using the function `CALENDAR_SetDate()`.

#### 7.3.4.3.1.4 CALENDAR\_GetDaysOfMonth()

##### Description

Returns the number of days in a specific month.

##### Prototype

```
int CALENDAR_GetDaysOfMonth(CALENDAR_DATE * pDate);
```

##### Parameters

Parameter	Description
<code>pDate</code>	Pointer to a CALENDAR_DATE structure.

##### Return value

≠ 0      Number of days in the given month of the given year.  
= 0      Error.

##### Additional information

The members `Year` and `Month` of the parameter have to be set to get the number of days of the specified month in the specified year.

### 7.3.4.3.1.5 CALENDAR\_GetSel()

#### Description

Returns the currently selected date.

#### Prototype

```
void CALENDAR_GetSel(WM_HWIN hWin,  
                    CALENDAR_DATE * pDate);
```

#### Parameters

Parameter	Description
<code>hWin</code>	Handle of CALENDAR dialog.
<code>pDate</code>	Pointer to a CALENDAR_DATE structure.

### 7.3.4.3.1.6 CALENDAR\_GetWeekday()

#### Description

Returns the number of the weekday of a given date.

#### Prototype

```
int CALENDAR_GetWeekday(CALENDAR_DATE * pDate);
```

#### Parameters

Parameter	Description
<code>pDate</code>	Pointer to CALENDAR_DATE structure.

#### Return value

0	Saturday
1	Sunday
2	Monday
3	Tuesday
4	Wednesday
5	Thursday
6	Friday

### 7.3.4.3.1.7 CALENDAR\_SetDate()

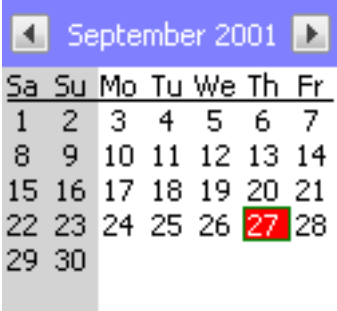
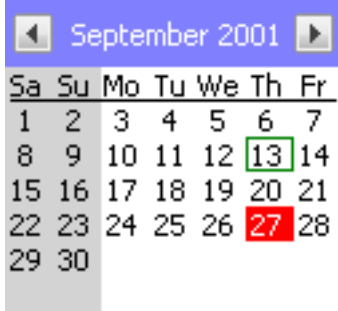
Before	After																																																																																				
 <p>September 2001</p> <table border="1"> <thead> <tr> <th>Sa</th> <th>Su</th> <th>Mo</th> <th>Tu</th> <th>We</th> <th>Th</th> <th>Fr</th> </tr> </thead> <tbody> <tr> <td>1</td> <td>2</td> <td>3</td> <td>4</td> <td>5</td> <td>6</td> <td>7</td> </tr> <tr> <td>8</td> <td>9</td> <td>10</td> <td>11</td> <td>12</td> <td>13</td> <td>14</td> </tr> <tr> <td>15</td> <td>16</td> <td>17</td> <td>18</td> <td>19</td> <td>20</td> <td>21</td> </tr> <tr> <td>22</td> <td>23</td> <td>24</td> <td>25</td> <td>26</td> <td>27</td> <td>28</td> </tr> <tr> <td>29</td> <td>30</td> <td></td> <td></td> <td></td> <td></td> <td></td> </tr> </tbody> </table>	Sa	Su	Mo	Tu	We	Th	Fr	1	2	3	4	5	6	7	8	9	10	11	12	13	14	15	16	17	18	19	20	21	22	23	24	25	26	27	28	29	30						 <p>September 2001</p> <table border="1"> <thead> <tr> <th>Sa</th> <th>Su</th> <th>Mo</th> <th>Tu</th> <th>We</th> <th>Th</th> <th>Fr</th> </tr> </thead> <tbody> <tr> <td>1</td> <td>2</td> <td>3</td> <td>4</td> <td>5</td> <td>6</td> <td>7</td> </tr> <tr> <td>8</td> <td>9</td> <td>10</td> <td>11</td> <td>12</td> <td>13</td> <td>14</td> </tr> <tr> <td>15</td> <td>16</td> <td>17</td> <td>18</td> <td>19</td> <td>20</td> <td>21</td> </tr> <tr> <td>22</td> <td>23</td> <td>24</td> <td>25</td> <td>26</td> <td>27</td> <td>28</td> </tr> <tr> <td>29</td> <td>30</td> <td></td> <td></td> <td></td> <td></td> <td></td> </tr> </tbody> </table>	Sa	Su	Mo	Tu	We	Th	Fr	1	2	3	4	5	6	7	8	9	10	11	12	13	14	15	16	17	18	19	20	21	22	23	24	25	26	27	28	29	30					
Sa	Su	Mo	Tu	We	Th	Fr																																																																															
1	2	3	4	5	6	7																																																																															
8	9	10	11	12	13	14																																																																															
15	16	17	18	19	20	21																																																																															
22	23	24	25	26	27	28																																																																															
29	30																																																																																				
Sa	Su	Mo	Tu	We	Th	Fr																																																																															
1	2	3	4	5	6	7																																																																															
8	9	10	11	12	13	14																																																																															
15	16	17	18	19	20	21																																																																															
22	23	24	25	26	27	28																																																																															
29	30																																																																																				

#### Description

Sets the current date.

#### Prototype

```
void CALENDAR_SetDate(WM_HWIN          hWin,
                     CALENDAR_DATE * pDate);
```

#### Parameters

Parameter	Description
<code>hWin</code>	Handle of CALENDAR dialog.
<code>pDate</code>	Pointer to a CALENDAR_DATE structure.

### 7.3.4.3.1.8 CALENDAR\_SetSel()

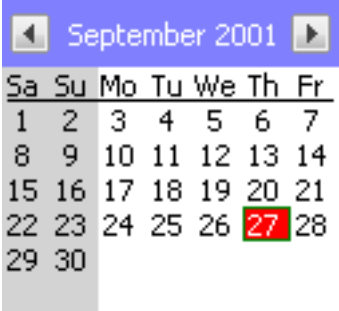
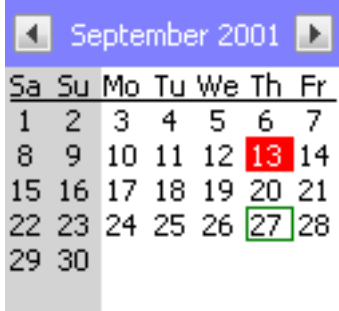
Before	After																																																																																				
 <p>September 2001</p> <table border="1"> <thead> <tr> <th>Sa</th> <th>Su</th> <th>Mo</th> <th>Tu</th> <th>We</th> <th>Th</th> <th>Fr</th> </tr> </thead> <tbody> <tr><td>1</td><td>2</td><td>3</td><td>4</td><td>5</td><td>6</td><td>7</td></tr> <tr><td>8</td><td>9</td><td>10</td><td>11</td><td>12</td><td>13</td><td>14</td></tr> <tr><td>15</td><td>16</td><td>17</td><td>18</td><td>19</td><td>20</td><td>21</td></tr> <tr><td>22</td><td>23</td><td>24</td><td>25</td><td>26</td><td>27</td><td>28</td></tr> <tr><td>29</td><td>30</td><td></td><td></td><td></td><td></td><td></td></tr> </tbody> </table>	Sa	Su	Mo	Tu	We	Th	Fr	1	2	3	4	5	6	7	8	9	10	11	12	13	14	15	16	17	18	19	20	21	22	23	24	25	26	27	28	29	30						 <p>September 2001</p> <table border="1"> <thead> <tr> <th>Sa</th> <th>Su</th> <th>Mo</th> <th>Tu</th> <th>We</th> <th>Th</th> <th>Fr</th> </tr> </thead> <tbody> <tr><td>1</td><td>2</td><td>3</td><td>4</td><td>5</td><td>6</td><td>7</td></tr> <tr><td>8</td><td>9</td><td>10</td><td>11</td><td>12</td><td>13</td><td>14</td></tr> <tr><td>15</td><td>16</td><td>17</td><td>18</td><td>19</td><td>20</td><td>21</td></tr> <tr><td>22</td><td>23</td><td>24</td><td>25</td><td>26</td><td>27</td><td>28</td></tr> <tr><td>29</td><td>30</td><td></td><td></td><td></td><td></td><td></td></tr> </tbody> </table>	Sa	Su	Mo	Tu	We	Th	Fr	1	2	3	4	5	6	7	8	9	10	11	12	13	14	15	16	17	18	19	20	21	22	23	24	25	26	27	28	29	30					
Sa	Su	Mo	Tu	We	Th	Fr																																																																															
1	2	3	4	5	6	7																																																																															
8	9	10	11	12	13	14																																																																															
15	16	17	18	19	20	21																																																																															
22	23	24	25	26	27	28																																																																															
29	30																																																																																				
Sa	Su	Mo	Tu	We	Th	Fr																																																																															
1	2	3	4	5	6	7																																																																															
8	9	10	11	12	13	14																																																																															
15	16	17	18	19	20	21																																																																															
22	23	24	25	26	27	28																																																																															
29	30																																																																																				

#### Description

Sets the currently selected date.

#### Prototype

```
void CALENDAR_SetSel(WM_HWIN          hWin,
                    CALENDAR_DATE * pDate);
```

#### Parameters

Parameter	Description
<code>hWin</code>	Handle of CALENDAR dialog.
<code>pDate</code>	Pointer to a CALENDAR_DATE structure.



### 7.3.4.3.1.9 CALENDAR\_SetDefaultBkColor()

#### Description

Sets the default background color to be used for new CALENDAR dialogs.

#### Prototype

```
void CALENDAR_SetDefaultBkColor(unsigned Index,  
                                GUI_COLOR Color);
```

#### Parameters

Parameter	Description
<code>Index</code>	See <i>CALENDAR color indexes</i> on page 2769. Only <b>...WEEK-END</b> , <b>...WEEKDAY</b> , <b>...SEL</b> and <b>...HEADER</b> are applicable for a background color.
<code>Color</code>	<code>Color</code> to be used

### 7.3.4.3.1.10 CALENDAR\_SetDefaultColor()

#### Description

Sets the default color to be used for new CALENDAR dialogs.

#### Prototype

```
void CALENDAR_SetDefaultColor(unsigned Index,  
                             GUI_COLOR Color);
```

#### Parameters

Parameter	Description
<a href="#">Index</a>	See <i>CALENDAR color indexes</i> on page 2769. <b>CALENDAR_CI_HEADER</b> is not applicable for this routine.
<a href="#">Color</a>	<a href="#">Color</a> to be used

### 7.3.4.3.1.11 CALENDAR\_SetDefaultDays()

#### Description

Sets the text to be used to label the days.

#### Prototype

```
void CALENDAR_SetDefaultDays(const char ** apDays);
```

#### Parameters

Parameter	Description
<code>apDays</code>	Pointer to an array of 7 string pointers containing the strings to be used.

#### Additional information

The first string of the array should point to the abbreviation of Saturday, the second to Sunday and so on. The array needs to have at least 7 strings. If there are too few strings passed to the function the behavior of emWin becomes undefined.

### 7.3.4.3.1.12 CALENDAR\_SetDefaultFont()

#### Description

Sets the font(s) to be used for drawing the CALENDAR items.

#### Prototype

```
void CALENDAR_SetDefaultFont(    unsigned   Index,  
                                const GUI_FONT * pFont);
```

#### Parameters

Parameter	Description
<a href="#">Index</a>	See <i>CALENDAR font indexes</i> on page 2770 for a full list of permitted values.
<a href="#">pFont</a>	Font to be used.

### 7.3.4.3.1.13 CALENDAR\_SetDefaultMonths()

#### Description

Sets the text to be used for the current month / year.

#### Prototype

```
void CALENDAR_SetDefaultMonths(const char ** apMonths);
```

#### Parameters

Parameter	Description
<code>apMonth</code>	Pointer to an array of 12 string pointers containing the strings to be used.

#### Additional information

The first string of the array should point to the text for 'January', the second to the text for 'February' and so on. The array needs to have at least 12 strings. If there are too few strings passed to the function the behavior of emWin becomes undefined.

### 7.3.4.3.1.14 CALENDAR\_SetDefaultSize()

#### Description

Sets the sizes to be used by the dialog.

#### Prototype

```
void CALENDAR_SetDefaultSize(unsigned Index,  
                             unsigned Size);
```

#### Parameters

Parameter	Description
<a href="#">Index</a>	See <i>CALENDAR size indexes</i> on page 2771 for a full list of permitted values.
<a href="#">Size</a>	<a href="#">Size</a> to be used.

#### Additional information

The size in x of the complete dialog can be calculated as follows:  $xSizeDialog = 7 * CellSizeX$   
The size in y of the complete dialog can be calculated as follows:  $ySizeDialog = 7 * CellSizeY + HeaderSizeY$

### 7.3.4.3.1.15 CALENDAR\_ShowDate()

#### Description

Shows a given date on the calendar.

#### Prototype

```
void CALENDAR_ShowDate(WM_HWIN      hWin,  
                       CALENDAR_DATE * pDate);
```

#### Parameters

Parameter	Description
<code>hWin</code>	Handle of CALENDAR dialog.
<code>pDate</code>	Pointer to a CALENDAR_DATE structure.

### 7.3.4.3.2 Data structures

#### 7.3.4.3.2.1 CALENDAR\_DATE

##### Description

Structure used by the routine `CALENDAR_GetDate()` to retrieve a date.

##### Type definition

```
typedef struct {  
    int Year;  
    int Month;  
    int Day;  
} CALENDAR_DATE;
```

##### Structure members

Member	Description
<code>Year</code>	<code>Year</code> of requested date.
<code>Month</code>	<code>Month</code> of requested date.
<code>Day</code>	<code>Day</code> of requested date.



### 7.3.4.3.3 Defines

#### 7.3.4.3.3.1 CALENDAR color indexes

##### Description

Color indexes used by the CALENDAR dialog.

##### Definition

```
#define CALENDAR_CI_WEEKEND      0
#define CALENDAR_CI_WEEKDAY     1
#define CALENDAR_CI_SEL         2
#define CALENDAR_CI_HEADER      3
#define CALENDAR_CI_MONTH       4
#define CALENDAR_CI_LABEL       5
#define CALENDAR_CI_FRAME       6
```

##### Symbols

Definition	Description
CALENDAR_CI_WEEKEND	Color to be used for weekend days.
CALENDAR_CI_WEEKDAY	Color to be used for weekdays.
CALENDAR_CI_SEL	Color to be used for the selection.
CALENDAR_CI_HEADER	Background color to be used for the header area.
CALENDAR_CI_MONTH	Color to be used for the month (and year) text.
CALENDAR_CI_LABEL	Color to be used for labeling the days.
CALENDAR_CI_FRAME	Color to be used for the frame of the current date.

### 7.3.4.3.3.2 CALENDAR font indexes

#### Description

Font indexes used by the CALENDAR dialog.

#### Definition

```
#define CALENDAR_FI_CONTENT    0  
#define CALENDAR_FI_HEADER    1
```

#### Symbols

Definition	Description
CALENDAR_FI_CONTENT	Font to be used for labeling and the numbers.
CALENDAR_FI_HEADER	Font to be used for month / year.

### 7.3.4.3.3 CALENDAR size indexes

#### Description

Size indexes used by the routine `CALENDAR_SetDefaultSize()`.

#### Definition

```
#define CALENDAR_SI_HEADER    0
#define CALENDAR_SI_CELL_X   1
#define CALENDAR_SI_CELL_Y   2
```

#### Symbols

Definition	Description
<a href="#">CALENDAR_SI_HEADER</a>	Y-size in pixels used for the header area. (default is 25)
<a href="#">CALENDAR_SI_CELL_X</a>	Cell size in X to be used for one item in the day pad. (default is 18)
<a href="#">CALENDAR_SI_CELL_Y</a>	Cell size in Y to be used for one item in the day pad. (default is 13)

## 7.3.5 CHOOSECOLOR dialog



The CHOOSECOLOR dialog can be used to select a color from a given color array.

### 7.3.5.1 Notification codes

The following events are sent from the dialog to its parent window as part of a WM\_NOTIFY\_PARENT message:

Message	Description
WM_NOTIFICATION_SEL_CHANGED	Sent immediately after a new color has been selected by the PID or the keyboard.
WM_NOTIFICATION_CHILD_DELETED	Sent when the dialog has been closed.
WM_NOTIFICATION_VALUE_CHANGED	Sent if the dialog was closed using the 'Ok' button with a different than the initial selection.

### 7.3.5.2 Keyboard reaction

The dialog reacts to the following keys if it has the input focus:

Key	Reaction
GUI_KEY_ESCAPE	Dialog execution will be canceled.
GUI_KEY_ENTER	Reaction depends on the focused button.
GUI_KEY_LEFT	Cursor moves to the left.
GUI_KEY_RIGHT	Cursor moves to the right.
GUI_KEY_UP	Cursor moves one line up.
GUI_KEY_DOWN	Cursor moves one line down.

### 7.3.5.3 CHOOSECOLOR API

The table below lists the available CHOOSECOLOR-related routines in alphabetical order. Detailed descriptions follow.

#### Functions

Routine	Description
<code>CHOOSECOLOR_Create()</code>	Creates a dialog for choosing a color and returns immediately.
<code>CHOOSECOLOR_GetSel()</code>	Returns the index of the currently selected color.
<code>CHOOSECOLOR_SetSel()</code>	Sets the current selection.
<code>CHOOSECOLOR_SetDefaultColor()</code>	Sets the colors to be used to draw the surrounding frame of the colors.
<code>CHOOSECOLOR_SetDefaultSpace()</code>	Determines the space between the color rectangles.
<code>CHOOSECOLOR_SetDefaultBorder()</code>	Sets the size of the border between the colors and the dialog frame to be used.
<code>CHOOSECOLOR_SetDefaultButtonSize()</code>	Sets the button size to be used.

#### Defines

Group of defines	Description
<code>CHOOSECOLOR_color_indexes</code>	Color indexes used by the CHOOSECOLOR dialog.

### 7.3.5.3.1 Functions

#### 7.3.5.3.1.1 CHOOSECOLOR\_Create()

##### Description

Creates a dialog for choosing a color and returns immediately.

##### Prototype

```
WM_HWIN CHOOSECOLOR_Create(
    WM_HWIN    hParent,
    int        xPos,
    int        yPos,
    int        xSize,
    int        ySize,
    const GUI_COLOR * pColor,
    unsigned   NumColors,
    unsigned   NumColorsPerLine,
    int        Sel,
    const char * sCaption,
    int        Flags);
```

##### Parameters

Parameter	Description
<code>hParent</code>	Handle of the parent window which should receive the notification messages.
<code>xPos</code>	X position in pixels of the dialog in client coordinates.
<code>yPos</code>	Y position in pixels of the dialog in client coordinates.
<code>xSize</code>	X-size of the dialog in pixels.
<code>ySize</code>	Y-size of the dialog in pixels.
<code>pColor</code>	Pointer to an array of 32 bit color values containing the colors to be used.
<code>NumColors</code>	Number of colors to be shown.
<code>NumColorsPerLine</code>	Number of colors to be shown per line.
<code>Sel</code>	Initial index value to be used for the selection / focus.
<code>sCaption</code>	Title to be shown in the title bar.
<code>Flags</code>	Additional flags for the FRAMEWIN widget.

##### Return value

Handle of the dialog on success, otherwise 0.

##### Additional information

The following default values are used:

- If (`xPos < 0`) the dialog will be centered horizontally.
- If (`yPos < 0`) the dialog will be centered vertically.
- If (`xSize = 0`) the half of the display size in x will be used.
- If (`ySize = 0`) the half of the display size in y will be used.
- if (`sCaption = NULL`) 'Choose Color' will be shown in the title bar. As mentioned above the creation routine returns immediately. It becomes visible with the next call of `WM_Exec()` or it can be executed with `GUI_ExecCreatedDialog()`.

### 7.3.5.3.1.2 CHOOSECOLOR\_GetSel()

#### Description

Returns the index of the currently selected color.

#### Prototype

```
int CHOOSECOLOR_GetSel(WM_HWIN hObj);
```

#### Parameters

Parameter	Description
<a href="#">hObj</a>	Handle of the CHOOSECOLOR dialog.

#### Return value

Index of the currently selected color.

### 7.3.5.3.1.3 CHOOSECOLOR\_SetSel()

#### Description

Sets the current selection.

#### Prototype

```
void CHOOSECOLOR_SetSel(WM_HWIN hObj,  
                        int Sel);
```

#### Parameters

Parameter	Description
<code>hObj</code>	Handle of the CHOOSECOLOR dialog.
<code>Sel</code>	New selection to be used.

#### Additional information

The given selection should be smaller than the number of colors. In case of a negative value no initial selection will be shown.



### 7.3.5.3.1.4 CHOOSECOLOR\_SetDefaultColor()



#### Description

Sets the colors to be used to draw the surrounding frame of the colors.

#### Prototype

```
void CHOOSECOLOR_SetDefaultColor(unsigned Index,
                                  GUI_COLOR Color);
```

#### Parameters

Parameter	Description
<a href="#">Index</a>	See <i>CHOOSECOLOR color indexes</i> on page 2781 for a full list of permitted values.
<a href="#">Color</a>	<a href="#">Color</a> to be used.

### 7.3.5.3.1.5 CHOOSECOLOR\_SetDefaultSpace()

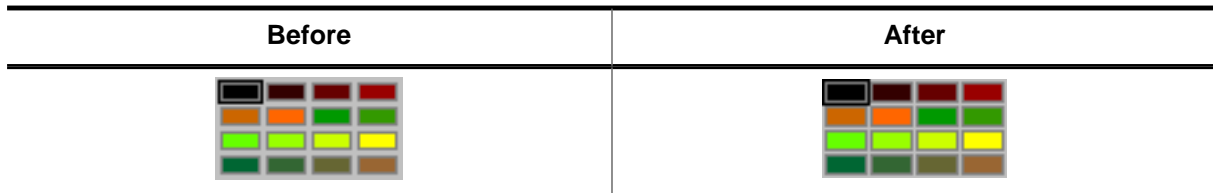

#### Description

Determines the space between the color rectangles.

#### Prototype

```
void CHOOSECOLOR_SetDefaultSpace(unsigned Index,
                                  unsigned Space);
```

#### Parameters

Parameter	Description
<a href="#">Index</a>	See table below.
<a href="#">Space</a>	<a href="#">Space</a> in pixels to be used.

Permitted values for parameter <a href="#">Index</a>	
GUI_COORD_X	<a href="#">Space</a> in X to be used between the colors. Default value is 5.
GUI_COORD_Y	<a href="#">Space</a> in Y to be used between the colors. Default value is 5.

### 7.3.5.3.1.6 CHOOSECOLOR\_SetDefaultBorder()



#### Description

Sets the size of the border between the colors and the dialog frame to be used.

#### Prototype

```
void CHOOSECOLOR_SetDefaultBorder(unsigned Index,
                                   unsigned Border);
```

#### Parameters

Parameter	Description
<a href="#">Index</a>	See table below.
<a href="#">Border</a>	<a href="#">Border</a> to be used.

Permitted values for parameter <a href="#">Index</a>	
GUI_COORD_X	Space in X to be used between border and colors. Default value is 4.
GUI_COORD_Y	Space in Y to be used between border and colors. Default value is 4.

#### Additional information

The horizontal value is also used to determine the space between the buttons.

### 7.3.5.3.1.7 CHOOSECOLOR\_SetDefaultButtonSize()

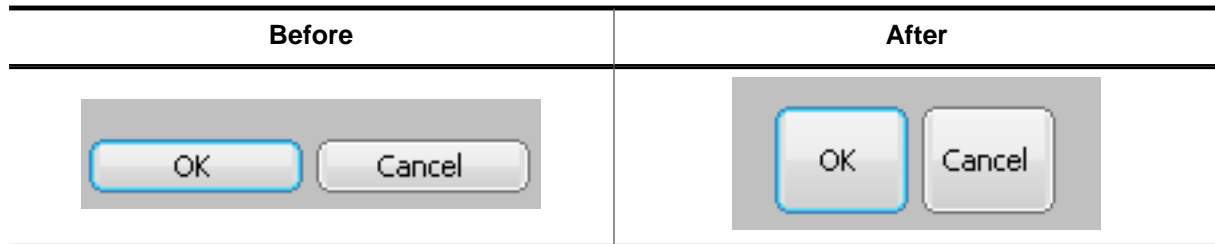

#### Description

Sets the button size to be used.

#### Prototype

```
void CHOOSECOLOR_SetDefaultButtonSize(unsigned Index,
                                       unsigned ButtonSize);
```

#### Parameters

Parameter	Description
<a href="#">Index</a>	See table below.
<a href="#">ButtonSize</a>	Size in pixels to be used.

Permitted values for parameter <a href="#">Index</a>	
GUI_COORD_X	Button size in X.
GUI_COORD_Y	Button size in Y.

### 7.3.5.3.2 Defines

#### 7.3.5.3.2.1 CHOOSECOLOR color indexes

##### Description

Color indexes used by the CHOOSECOLOR dialog.

##### Definition

```
#define CHOOSECOLOR_CI_FRAME    0
#define CHOOSECOLOR_CI_FOCUS   1
```

##### Symbols

Definition	Description
<a href="#">CHOOSECOLOR_CI_FRAME</a>	Color to be used to draw the frame surrounding each color. Default is GUI_GRAY.
<a href="#">CHOOSECOLOR_CI_FOCUS</a>	Color to be used to draw the focus rectangle. Default is GUI_BLACK.

## 7.3.6 CHOOSEFILE dialog

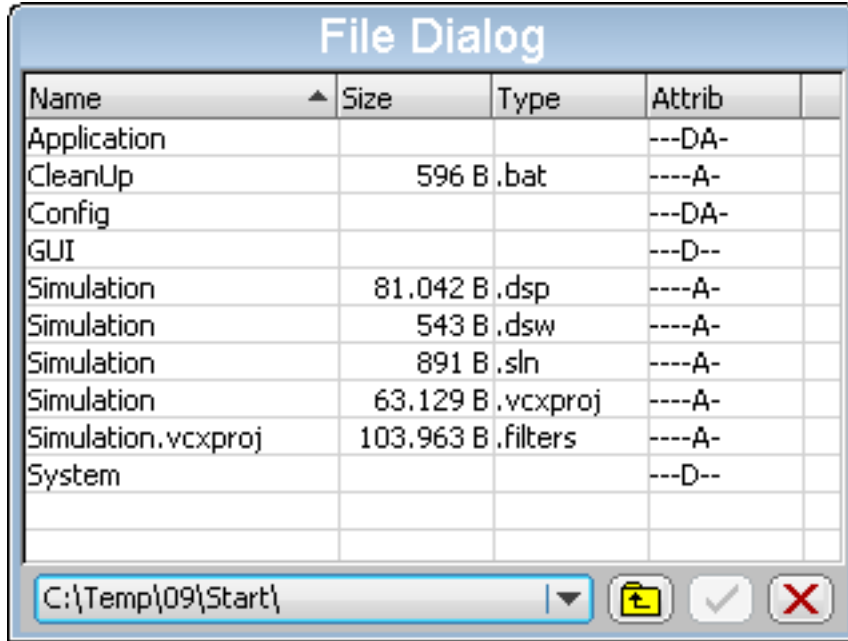

The CHOOSEFILE dialog can be used for browsing through a directory and for selecting a file. It uses a user defined callback routine for retrieving data. So it can be used with any file system.

### 7.3.6.1 Configuring options

Type	Macro	Default	Description
N	CHOOSEFILE_DELIM	\	Default delimiter to be used.

### 7.3.6.2 Keyboard reaction

The dialog reacts to the following keys if it has the input focus:

Key	Reaction
GUI_KEY_TAB	The next widget of the dialog gains the input focus.
GUI_KEY_BACKTAB	The previous widget of the dialog gains the input focus.
GUI_KEY_ENTER	The behavior depends on the currently focused widget.
GUI_KEY_ESCAPE	Dialog will be canceled.

### 7.3.6.3 Path- and file names

The maximum length of path- and file names is limited to 256 bytes.

### 7.3.6.4 CHOOSEFILE API

The table below lists the available CHOOSEFILE-related routines in alphabetical order. Detailed descriptions of the routines follow.

#### Functions

Routine	Description
<code>CHOOSEFILE_Create()</code>	Creates a CHOOSEFILE dialog using the given parameters.
<code>CHOOSEFILE_EnableToolTips()</code>	Enables ToolTips for CHOOSEFILE dialogs.
<code>CHOOSEFILE_SetButtonText()</code>	Uses text instead of the default image.
<code>CHOOSEFILE_SetDefaultButtonText()</code>	Sets the default text to be used for new dialogs.
<code>CHOOSEFILE_SetDelim()</code>	Sets the delimiter used within a path.
<code>CHOOSEFILE_SetToolTips()</code>	Sets the text to be shown by the ToolTips.
<code>CHOOSEFILE_SetTopMode()</code>	Makes the button bar visible at the top of the dialog.

#### Data structures

Structure	Description
<code>CHOOSEFILE_INFO</code>	

#### Defines

Group of defines	Description
<code>CHOOSEFILE_button_indexes</code>	Bitmap indexes used by the CHOOSEFILE dialog.

#### Prototypes

Prototype	Description
<code>CHOOSEFILE_GET_DATA_FUNC</code>	A callback which has to pass information about the requested file to the dialog.

### 7.3.6.4.1 Functions

#### 7.3.6.4.1.1 CHOOSEFILE\_Create()

##### Description

Creates a CHOOSEFILE dialog using the given parameters.

##### Prototype

```
WM_HWIN CHOOSEFILE_Create(      WM_HWIN      hParent,
                                int              xPos,
                                int              yPos,
                                int              xSize,
                                int              ySize,
                                const char      * apRoot[],
                                int              NumRoot,
                                int              SelRoot,
                                const char      * sCaption,
                                int              Flags,
                                CHOOSEFILE_INFO * pInfo);
```

##### Parameters

Parameter	Description
<code>hParent</code>	Handle of parent window.
<code>xPos</code>	X position in pixels of the dialog in client coordinates.
<code>yPos</code>	Y position in pixels of the dialog in client coordinates.
<code>xSize</code>	X-size of the dialog in pixels.
<code>ySize</code>	Y-size of the dialog in pixels.
<code>apRoot</code>	<input type="checkbox"/> Pointer to an array of strings containing the root directories to be used.
<code>NumRoot</code>	Number of root directories.
<code>SelRoot</code>	Initial index of the root directory to be used.
<code>sCaption</code>	<input type="checkbox"/> Title to be shown in the title bar.
<code>Flags</code>	Additional flags for the FRAMEWIN widget.
<code>pInfo</code>	<input type="checkbox"/> Pointer to a CHOOSEFILE_INFO structure.

##### Parameter `apRoot`

This parameter should point to an array of string pointers containing the root directories shown in the DROPDOWN widget of the dialog. The directory names do not need to have a delimiter (slash or backslash) at the end. They are copied by the function to their own locations and do not need to remain valid after creating the dialog. Empty strings are not supported and could lead to an undefined behavior of the dialog.

##### Return value

Handle of the dialog on success, otherwise 0.

##### Additional information

The following default values are used:

- If `xPos` < 0, the dialog will be centered horizontally.
- If `yPos` < 0, the dialog will be centered vertically.
- If `xSize` = 0, the half of the display size in x will be used.
- If `ySize` = 0, the half of the display size in y will be used.
- If `sCaption` = NULL, 'Choose File' will be shown in the title bar.



### 7.3.6.4.1.2 CHOOSEFILE\_EnableToolTips()

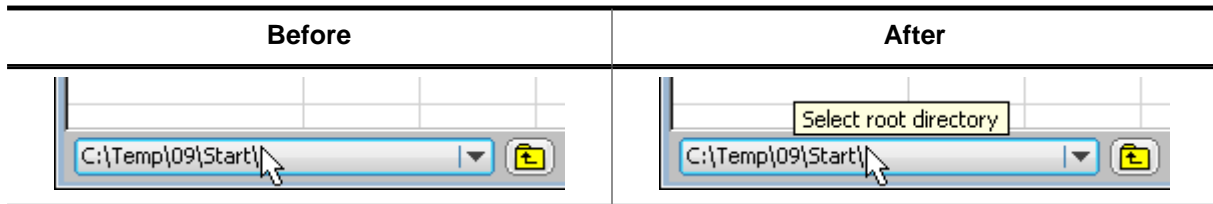

#### Description

Enables ToolTips for CHOOSEFILE dialogs.

#### Prototype

```
void CHOOSEFILE_EnableToolTips(void);
```

#### Additional information

The text of the ToolTips can be configured. Details can be found in the description of `CHOOSEFILE_SetToolTips`.

### 7.3.6.4.1.3 CHOOSEFILE\_SetButtonText()

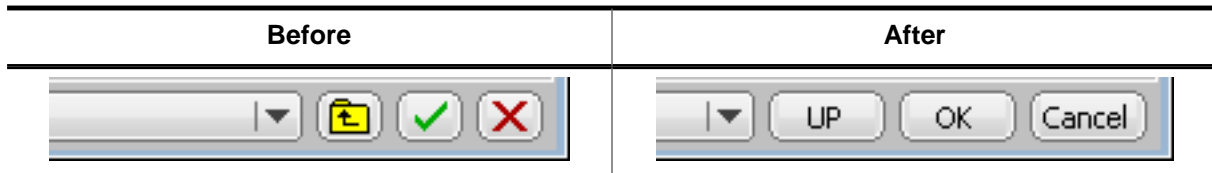

#### Description

Uses text instead of the default image.

#### Prototype

```
void CHOOSEFILE_SetButtonText(    WM_HWIN    hWin,
                                unsigned  ButtonIndex,
                                const char * pText);
```

#### Parameters

Parameter	Description
<code>hWin</code>	Handle of the CHOOSEFILE dialog.
<code>ButtonIndex</code>	See <i>CHOOSEFILE</i> button indexes on page 2793 for a full list of permitted values.
<code>pText</code>	Pointer to a string to be used.

#### Additional information

The function copies the string(s) into its own memory location(s). The size of the buttons depend on the used text. The dialog makes sure, that all buttons which use text instead of an image have the same size.

#### 7.3.6.4.1.4 CHOOSEFILE\_SetDefaultButtonText()

##### Description

Sets the default text to be used for new dialogs.

##### Prototype

```
void CHOOSEFILE_SetDefaultButtonText(    unsigned   ButtonIndex,  
                                       const char  * pText);
```

##### Parameters

Parameter	Description
<a href="#">ButtonIndex</a>	See <i>CHOOSEFILE</i> button indexes on page 2793 for a full list of permitted values.
<a href="#">pText</a>	Text to be used per default.

### 7.3.6.4.1.5 CHOOSEFILE\_SetDelim()

#### Description

Sets the delimiter used within a path. Default is a backslash.

#### Prototype

```
void CHOOSEFILE_SetDelim(char Delim);
```

#### Parameters

Parameter	Description
Delim	Delimiter to be used.

### 7.3.6.4.1.6 CHOOSEFILE\_SetToolTips()

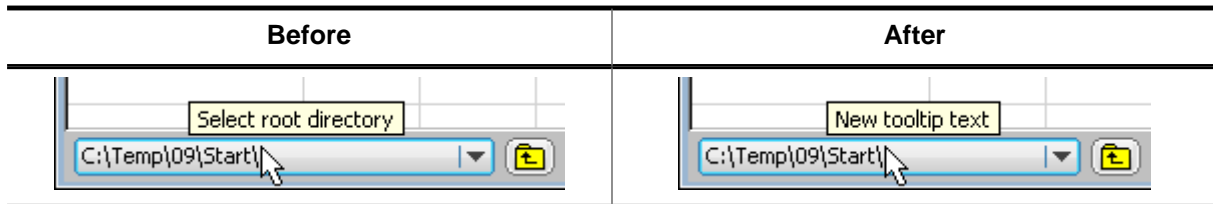

#### Description

Sets the text to be shown by the ToolTips.

#### Prototype

```
void CHOOSEFILE_SetToolTips(const TOOL TIP_INFO * pInfo,
                             int NumItems);
```

#### Parameters

Parameter	Description
<code>pInfo</code>	Pointer to an array of <code>TOOL TIP_INFO</code> structures.
<code>NumItems</code>	Number of items pointed by <code>pInfo</code> .

#### Additional information

The elements of the `TOOL TIP_INFO` structure are described in the section *ToolTips* on page 973.

### 7.3.6.4.1.7 CHOOSEFILE\_SetTopMode()

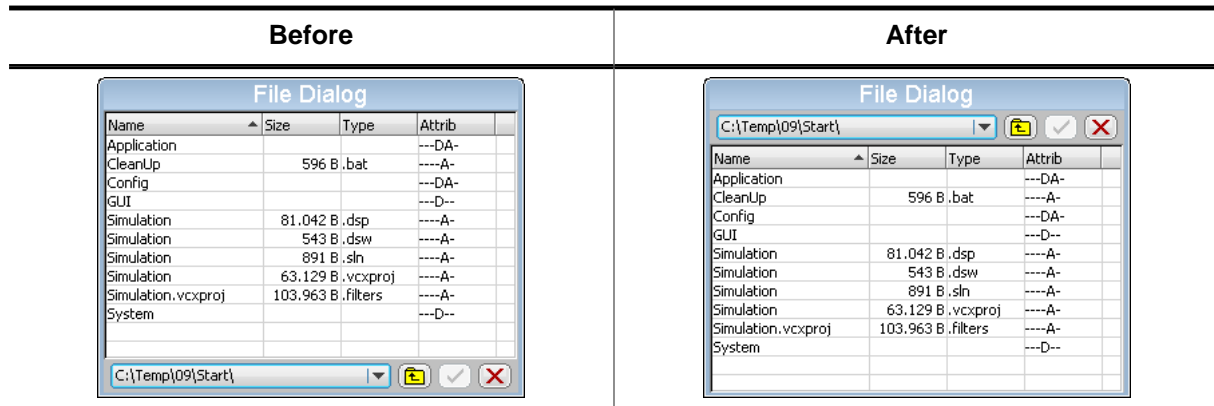

#### Description

Makes the button bar visible at the top of the dialog.

#### Prototype

```
void CHOOSEFILE_SetTopMode( unsigned OnOff );
```

#### Parameters

Parameter	Description
<code>OnOff</code>	1 for top mode, 0 (default) for bottom mode.

### 7.3.6.4.2 Data structures

#### 7.3.6.4.2.1 CHOOSEFILE\_INFO

##### Description

Structure that contains information for creating a CHOOSEFILE dialog.

The structure is also passed to a CHOOSEFILE\_GET\_DATA\_FUNC and contains information about a given file or directory.

##### Type definition

```
typedef struct {
    int                Cmd;
    const char        * pMask;
    char              * pName;
    char              * pExt;
    char              * pAttrib;
    U32               SizeL;
    U32               SizeH;
    U32               Flags;
    char              pRoot[CHOOSEFILE_MAXLEN];
    CHOOSEFILE_GET_DATA_FUNC * pfGetData;
} CHOOSEFILE_INFO;
```

##### Structure members

Member	Description
<a href="#">Cmd</a>	Command for GetData() function. See below.
<a href="#">pMask</a>	This parameter is passed to the GetData() function and contains a mask which can be used for filtering the search result.
<a href="#">pName</a>	Pointer to the file name of the requested file.
<a href="#">pExt</a>	Pointer to the extension of the requested file.
<a href="#">pAttrib</a>	Pointer to the attribute string of the requested file.
<a href="#">SizeL</a>	Lower 32 bit of the file size.
<a href="#">SizeH</a>	Upper 32 bit of the file size.
<a href="#">Flags</a>	If the requested file is a directory it should be set to CHOOSEFILE_FLAG_DIRECTORY, otherwise it should be set to 0.
<a href="#">pRoot</a>	Pointer to a string containing the complete path of the currently used directory.
<a href="#">pfGetData</a>	Pointer to the GetData() function to be used.

##### Permitted values for element [Cmd](#)

CHOOSEFILE_FINDFIRST	The first entry of the current directory should be returned.
CHOOSEFILE_FINDNEXT	The next entry of the current directory should be returned.

##### Element CHOOSEFILE\_FINDFIRST

This command is sent to the given callback routine to get the first entry of the current directory. The element [pRoot](#) of the CHOOSEFILE\_INFO structure pointed by the parameter [pInfo](#) of the callback function contains the path to be used.

The following elements of the CHOOSEFILE\_INFO structure should be used by the application to return information of the requested file: [pName](#), [pExt](#), [pAttrib](#), [SizeL](#), [SizeH](#) and [Flags](#).

The parameter `pAttrib` contains a string to be shown in the 'Attrib' column. This string has to be build by the application. So each attributes independent of the used file system can be shown.

All strings used to return information about the file are copied by the dialog into its own memory locations.

If no file could be found the `GetData()` function should return 1.

### **Element CHOOSEFILE\_FINDNEXT**

This command is sent to the given callback routine to get the next entry of the chosen directory. If no further file could be found the `GetData()` function should return 1.



### 7.3.6.4.3 Defines

#### 7.3.6.4.3.1 CHOOSEFILE button indexes

##### Description

Button indexes used by the CHOOSEFILE dialog.

##### Definition

```
#define CHOOSEFILE_BI_CANCEL    0
#define CHOOSEFILE_BI_OK       1
#define CHOOSEFILE_BI_UP       2
```

##### Symbols

Definition	Description
<a href="#">CHOOSEFILE_BI_CANCEL</a>	Index of 'Cancel' button.
<a href="#">CHOOSEFILE_BI_OK</a>	Index of 'Ok' button.
<a href="#">CHOOSEFILE_BI_UP</a>	Index of 'Up' button.

### 7.3.6.4.4 Prototypes

#### 7.3.6.4.4.1 CHOOSEFILE\_GET\_DATA\_FUNC

##### Description

A callback which has to pass information about the requested file to the dialog.

##### Type definition

```
typedef int CHOOSEFILE_GET_DATA_FUNC(CHOOSEFILE_INFO * pInfo);
```

##### Parameters

Parameter	Description
<code>pInfo</code>	<b>in/out</b> Pointer to a <code>CHOOSEFILE_INFO</code> structure which contains all details of the requested file and needs to be filled by the function.

##### Return value

0 On success.  
1 On error.

##### Additional information

The following structure elements of `pInfo` have to be set by this function:

- `pInfo->Cmd`: Determines if information about the first or the next file should be returned.
- `pInfo->pRoot`: Pointer to a string containing the path of the directory to be used. The `GetData()` function then has to use the following elements for providing information about the requested file to the dialog:
- `pInfo->pAttrib`: Should point to a string which is shown in the 'Type' column. Because the CHOOSEFILE dialog can be used with any file system there are no special flags but a string which should be passed by the application to the dialog.
- `pInfo->pName`: Should point to a string which contains the file name without path and extension. Shown in the 'Name' column of the dialog.
- `pInfo->pExt`: Should point to a string which contains the extension of the file shown in the 'Type' column of the dialog.
- `pInfo->sizeL`: Should be set to the lower 32 bit of the file length.
- `pInfo->sizeH`: Should be set to the upper 32 bit of the file length in case of file larger than 4,294,967,295 bytes.
- `pInfo->Flags`: If the requested file is a directory this element has to be set to `CHOOSEFILE_FLAG_DIRECTORY`. Otherwise it has to be 0.

##### Example

The following shows an example of the `GetData()` function which can be used with WIN32. The sample folder also contains a sample which can be used with `emFile`. Here the WIN32 example:

```
static const struct {
    U32 Mask;
    char c;
} _aAttrib[] = {
    { FILE_ATTRIBUTE_READONLY , 'R' },
    { FILE_ATTRIBUTE_HIDDEN   , 'H' },
    { FILE_ATTRIBUTE_SYSTEM   , 'S' },
    { FILE_ATTRIBUTE_DIRECTORY, 'D' },
    { FILE_ATTRIBUTE_ARCHIVE  , 'A' },
    { FILE_ATTRIBUTE_NORMAL   , 'N' },
};
static int _GetData(CHOOSEFILE_INFO * pInfo) {
```

```

static HANDLE hFind;
static int NewDir;
static char acDrive [_MAX_DRIVE];
static char acDir  [_MAX_DIR];
static char acName  [_MAX_FNAME];
static char acExt   [_MAX_EXT];
static char acMask  [_MAX_PATH];
static char acPath  [_MAX_PATH];
static char acAttrib[10] = {0};
WIN32_FIND_DATA Context;
int i, r;
char c;
switch (pInfo->Cmd) {
case CHOOSEFILE_FINDFIRST:
    if (hFind != 0) {
        FindClose(hFind);
    }
    //
    // Split path into drive and directory
    //
    _splitpath(pInfo->pRoot, acDrive, acDir, NULL, NULL);
    NewDir = 1;
    //
    // Do not 'break' here...
    //
case CHOOSEFILE_FINDNEXT:
    if (NewDir) {
        _makepath(acMask, acDrive, acDir, NULL, NULL);
        strcat(acMask, pInfo->pMask);
        hFind = FindFirstFile(acMask, &Context);
        if (hFind == INVALID_HANDLE_VALUE) {
            FindClose(hFind);
            hFind = 0;
            return 1;
        }
    } else {
        r = FindNextFile(hFind, &Context);
        if (r == 0) {
            FindClose(hFind);
            hFind = 0;
            return 1;
        }
    }
    NewDir = 0;
    //
    // Generate attribute string (pInfo->pAttrib)
    //
    for (i = 0; i < GUI_COUNTOF(_aAttrib); i++) {
        c = (Context.dwFileAttributes & _aAttrib[i].Mask) ? _aAttrib[i].c : '-';
        acAttrib[i] = c;
    }
    //
    // Make name and extension (pInfo->pName, pInfo->pExt)
    //
    if ((Context.dwFileAttributes & FILE_ATTRIBUTE_DIRECTORY) == 0) {
        _splitpath(Context.cFileName, NULL, NULL, acName, acExt);
    } else {
        strcpy(acName, Context.cFileName);
        acExt[0] = 0;
    }
    //
    // Pass data to dialog
    //
    pInfo->pAttrib = acAttrib;
    pInfo->pName   = acName;
    pInfo->pExt    = acExt;
    pInfo->SizeL  = Context.nFileSizeLow;
    pInfo->SizeH  = Context.nFileSizeHigh;

```

```
pInfo->Flags = (Context.dwFileAttributes & FILE_ATTRIBUTE_DIRECTORY)
              ? CHOOSEFILE_FLAG_DIRECTORY : 0;
}
return 0;
}
```

## 7.3.7 MESSAGEBOX dialog

A MESSAGEBOX is used to show a message in a frame window with a title bar, as well as an "OK" button which must be pressed in order to close the window. It requires only one line of code to create or to create and execute a message box.

### Note

All MESSAGEBOX-related routines are in the file(s) MESSAGEBOX\*.c, MESSAGEBOX.h and GUI.h.

### Simple message boxes



### 7.3.7.1 Configuration options

Type	Macro	Default	Description
N	MESSAGEBOX_BORDER	4	Distance between the elements of a message box and the elements of the client window frame.
N	MESSAGEBOX_XSIZEOK	50	X-size of the "OK" button.
N	MESSAGEBOX_YSIZEOK	20	Y-size of the "OK" button.
S	MESSAGEBOX_BKCOLOR	GUI_WHITE	Color of the client window background.

### 7.3.7.2 Keyboard reaction

The widget consists of a FRAMEWIN, a TEXT and a BUTTON widget. When executing a message box the BUTTON widget gains the input focus. Detailed information on how keyboard events are handled by the BUTTON widget can be found in the section *BUTTON: Button widget* on page 1177.

### 7.3.7.3 MESSAGEBOX API

The table below lists the available emWin MESSAGEBOX-related routines in alphabetical order. Detailed descriptions follow.

Routine	Description
<a href="#">GUI_MessageBox()</a>	Creates and displays a message box.
<a href="#">MESSAGEBOX_Create()</a>	Creates a message box.

### 7.3.7.3.1 GUI\_MessageBox()

#### Description

Creates and displays a message box.

#### Prototype

```
int GUI_MessageBox(const char * sMessage,
                  const char * sCaption,
                  int    Flags);
```

#### Parameters

Parameter	Description
<code>sMessage</code>	Message to display.
<code>sCaption</code>	Caption for the title bar of the frame window.
<code>Flags</code>	See table below.

Permitted values for parameter <code>Flags</code>	
<code>GUI_MESSAGEBOX_CF_MOVEABLE</code>	The message box can be moved by dragging the title bar or the frame.
<code>0</code>	No function.

#### Additional information

This function offers the possibility to create and execute a MESSAGEBOX with one line of code. An example implementation can be found in the sample application `DIALOG_MessageBox.c` which is located in the `Sample` folder. Details about dragging can be found in the description of `FRAMEWIN_SetMoveable()`.

### 7.3.7.3.2 MESSAGEBOX\_Create()

#### Description

Creates a message box.

#### Prototype

```
WM_HWIN MESSAGEBOX_Create(const char * sMessage,
                          const char * sCaption,
                          int      Flags);
```

#### Parameters

Parameter	Description
<code>sMessage</code>	Message to display.
<code>sCaption</code>	Caption for the title bar of the frame window.
<code>Flags</code>	See table below.

Permitted values for parameter <code>Flags</code>	
<code>GUI_MESSAGEBOX_CF_MODAL</code>	Creates a modal message box. The default is creating a non modal message box.

#### Return value

Handle of the message box window.

#### Additional information

The function creates a message box consisting of a frame window with the caption text in the title bar, a text widget with the message text and a button widget representing the 'OK' button. After creating the message box the dialog behavior may be changed by using a user defined callback function or the properties of the box items can be modified using the widget API functions.

The following IDs can be used for accessing the items:

ID	Description
<code>GUI_ID_TEXT0</code>	ID of the TEXT widget containing the message text.
<code>GUI_ID_OK</code>	ID of the 'OK' BUTTON widget.

The frame window can be accessed by the handle returned by this function. The function `GUI_ExecCreatedDialog()` should be used to execute the message box.

## 7.4 Skinning

Skinning is a method of changing the appearance of one or multiple widgets. It allows changing the look by using a dedicated skin which defines how the widgets are rendered. This makes it easy to change the appearance of a complete group of widgets in a similar way by changing only the skin.

Without skinning, widget member functions have to be used to change the look for each single widget or the callback function has to be overwritten.



### 7.4.1 What is a 'skin'

A skin is just a simple callback function which is available for drawing all details of a widget. It works by exactly same way as a 'user draw function' of a widget, an older method of widget customization which was available before skinning was implemented.

### 7.4.2 From using API functions to skinning

There are different methods to change the appearance of a widget. Widget API functions, user draw functions, skinning and overwriting the callback function can be used to modify the appearance of a widget. The decision of the method to be used depends on what should be changed. The following explains what can be achieved with each method.

#### Using widget API functions

The default API functions can be used to change attributes like size, color, font or bitmaps used to draw a widget using the classical design. The following screenshot shows a typical sample of what can be done:

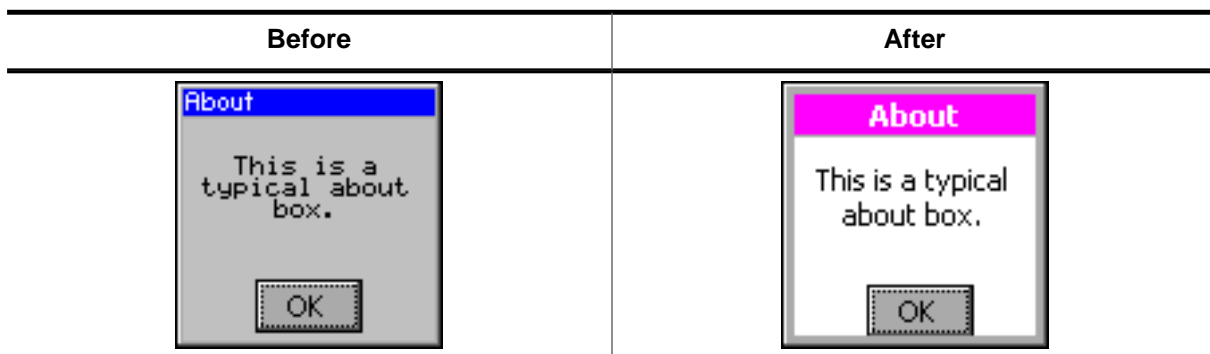

Some attributes can be changed but the basic appearance stays the same.





### User draw functions

Some widgets like LISTBOX, FRAMEWIN, GRAPH or BUTTON widgets offer user draw functions. These functions can be used to draw some additional details or to replace the default drawing method for some items. The following screenshot shows a user drawn title area of a frame window. The user draw function renders the gradient in the title area, which can't be achieved with the widget API functions:

Before	After
	

### Skinning

Contrary to the methods mentioned above skinning covers the drawing of the whole widget and not only some details. We also used this opportunity to lift the appearance of the skinnable widgets which look much more up-to-date as the classical widget design. The following table shows the look of the about box from above in comparison with the new default skin:

Classical design	Default skin
	

### Overwriting the callback function of a widget

Before skinning was implemented, the only method of changing the complete appearance of a widget was overwriting the callback function of a widget. This gives full control over the complete message processing of the widget. It can be used in combination with the other methods. The main disadvantage of overwriting the callback function is that lots of code needs to be written by the user. This process is prone to error.

### Using widget API for skinned widgets

Some functions do not have an effect anymore on widget properties. For example, the function `BUTTON_SetColor()` doesn't work with the Flex skin, due to the fact that the `BUTTON` doesn't consist of a single color anymore.

### 7.4.3 Skinnable widgets

Skinning only makes sense if a widget consists of several widget specific details. It does not make sense for each kind of widget. A TEXT widget for example does not require a separate skin, because it consists only of the text itself.

Currently the following widgets support skinning:

- BUTTON
- CHECKBOX
- DROPDOWN
- FRAMEWIN
- HEADER
- MENU
- MULTIPAGE
- PROGBAR
- RADIO
- SCROLLBAR
- SLIDER
- SPINBOX

### 7.4.4 Using a skin

The shipment of emWin contains a ready-to-use default skin for all above listed skinnable widgets. They have been named <WIDGET>\_SKIN\_FLEX.

The following table shows the available default skins for all skinnable widgets:

Widget	Default skin
BUTTON	BUTTON_SKIN_FLEX
CHECKBOX	CHECKBOX_SKIN_FLEX
DROPDOWN	DROPDOWN_SKIN_FLEX
FRAMEWIN	FRAMEWIN_SKIN_FLEX
HEADER	HEADER_SKIN_FLEX
MENU	MENU_SKIN_FLEX
MULTIPAGE	MULTIPAGE_SKIN_FLEX
PROGBAR	PROGBAR_SKIN_FLEX
RADIO	RADIO_SKIN_FLEX
SCROLLBAR	SCROLLBAR_SKIN_FLEX
SLIDER	SLIDER_SKIN_FLEX
SPINBOX	SPINBOX_SKIN_FLEX

### 7.4.4.1 Runtime configuration

To use these skins the function `<WIDGET>_SetSkin(<WIDGET>_SKIN_FLEX)` can be used. Further it is possible to set a default skin by `<WIDGET>_SetDefaultSkin()` which is used automatically for each new widget.

#### Switching from classic design to a skin

The most recommended way of using a skin is first setup the widget behavior and then creating the widget.

#### Example

The following example shows how a skin can be used:

```
BUTTON_SetSkin(hButton, BUTTON_SKIN_FLEX); // Sets the skin for the given widget
BUTTON_SetDefaultSkin(BUTTON_SKIN_FLEX); // Sets the default skin for new widgets
```

#### Additional information

<code>&lt;WIDGET&gt;_SetSkin()</code>	can be called at any time causing the given widget to use the set skinning routine.
<code>&lt;WIDGET&gt;_SetDefaultSkin()</code>	has to be called before creating the widget which should use the set skinning routine.
<code>&lt;WIDGET&gt;_SetDefaultSkin()</code>	should be used when multiple or all widgets should use the same skinning routine.

### 7.4.4.2 Compile-time configuration

If Skinning should be used by default the compile time configuration macro `WIDGET_USE_FLEX_SKIN` needs to be defined as 1 in `GUIConf.h`.

#### Example

To use skinning per default the macro should be added to the file `GUIConf.h`:

```
#define WIDGET_USE_FLEX_SKIN 1
```

## 7.4.5 Simple changes to the look of the 'Flex' skin

Similar to the API functions available for changing the attributes of the classical look the attributes of the 'Flex' skin can also be changed. This can be done without knowing all details of the skinning mechanism.

The function(s) `<WIDGET>_SetSkinFlexProps()` explained in detail later in this chapter can be used to change the attributes. For each skin exist functions for getting and setting the attributes.

#### Example

The following code shows how to change the attributes of the button skin:

```
BUTTON_GetSkinFlexProps(&Props, BUTTON_SKINFLEX_FOCUSED);
Props.aColorFrame[0] = 0x007FB13C;
Props.aColorFrame[1] = 0x008FfF8F;
Props.Radius = 6;
BUTTON_SetSkinFlexProps(&Props, BUTTON_SKINFLEX_FOCUSED);
WM_InvalidateWindow(hWin);
```

Since skin properties are general to a certain type of widget, setting skin properties does not invalidate any window. Widgets which are affected by any changes have to be invalidated as shown above.

## Screenshot



## 7.4.6 Major changes to the 'Flex' skin

The drawing mechanism of the default design without skinning is a 'black box' for the application designer. The same is true for skinning if no major changes of the default look are required. If changing the attributes of the default skin is not sufficient to realize the required look, it is required to understand the details of the drawing mechanism of skinning.

### 7.4.6.1 The skinning callback mechanism

The drawing mechanism for all skinnable widgets is very similar and looks as follows:

```
int <WIDGET>_DrawSkin(const WIDGET_ITEM_DRAW_INFO * pDrawItemInfo) {
    switch (pDrawItemInfo->Cmd) {
        case WIDGET_ITEM_DRAW_BACKGROUND:
            /* Draw the background */
            break;
        case WIDGET_ITEM_DRAW_TEXT:
            /* Draw the text */
            break;
        case WIDGET_ITEM_CREATE:
            /* Additional function calls required to create the widget */
            break;
        ...
    }
}
```

#### Elements of structure WIDGET\_ITEM\_DRAW\_INFO

Data type	Element	Description
WM_HWIN	hWin	Handle to the widget.
int	Cmd	Command to be processed.
int	ItemIndex	Index of item to be drawn.
int	x0	Leftmost coordinate in window coordinates.
int	y0	Topmost coordinate in window coordinates.
int	x1	Rightmost coordinate in window coordinates.
int	y1	Bottommost coordinate in window coordinates.
void *	p	Data pointer to widget specific information.

This scheme is identical to all skinnable widgets. The callback function receives a pointer to a WIDGET\_ITEM\_DRAW\_INFO structure. The structure pointed by pDrawItemInfo contains a command which has to be processed, a handle to the widget and further information whose meaning may vary by widget. The skinning callback function has to react with drawing a dedicated detail or with returning a dedicated value. How to use the drawing information in detail is explained later in this chapter.

### 7.4.6.2 Changing the look of the default skin

Understanding the above callback mechanism is important because changing a skin can easily be done by deriving a new skin from an existing one. A small example should show how the look of the default skin of a widget can be changed. Assuming the default look of the frame window skin should be changed because an icon should be shown on the left side of the title bar. The default appearance of the FRAMEWIN skin is as follows:

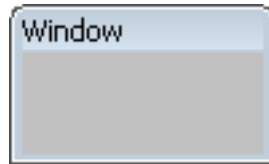

This should be changed to the following:

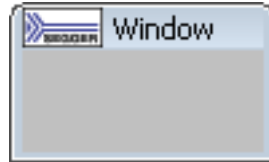

This can be done easily by using a customized skin derived from the default skin. The following code shows how this can be achieved. It shows a custom skinning callback function which is used as skin by the function `FRAMEWIN_SetSkin()`. Because the icon should be drawn in the text area of the frame window the function overwrites the default behavior of the text drawing:

```
case WIDGET_ITEM_DRAW_TEXT:
    ...
    All other tasks should be performed by the default skin:
    default:
        return FRAMEWIN_DrawSkinFlex(pDrawItemInfo);
```

## Example

```
static int _DrawSkinFlex_FRAME(const WIDGET_ITEM_DRAW_INFO * pDrawItemInfo) {
    char acBuffer[20];
    GUI_RECT Rect;
    switch (pDrawItemInfo->Cmd) {
        case WIDGET_ITEM_DRAW_TEXT:
            //
            // Draw icon at the left side
            //
            GUI_DrawBitmap(&_bmLogo_30x15, pDrawItemInfo->x0, pDrawItemInfo->y0);
            //
            // Draw text beneath
            //
            FRAMEWIN_GetText(pDrawItemInfo->hWin, acBuffer, sizeof(acBuffer));
            GUI_SetColor(GUI_BLACK);
            Rect.x0 = pDrawItemInfo->x0 // Default position of text
                + _bmLogo_30x15.XSize // + X-size of icon
                + 4; // + small gap between icon and text
            Rect.y0 = pDrawItemInfo->y0;
            Rect.x1 = pDrawItemInfo->x1;
            Rect.y1 = pDrawItemInfo->y1;
            GUI_DispStringInRect(acBuffer, &Rect, GUI_TA_VCENTER);
            break;
        default:
            //
            // Use the default skinning routine for processing all other commands
            //
            return FRAMEWIN_DrawSkinFlex(pDrawItemInfo);
    }
    return 0;
}

void _SetSkin(WM_HWIN) {
    //
    // Set the derived
    //
    FRAMEWIN_SetSkin(hFrame, _DrawSkinFlex_FRAME);
}
```

### 7.4.6.3 List of commands

The skinning routine receives a pointer to a `WIDGET_ITEM_DRAW_INFO` structure. The `Cmd` member of this structure contains the command which needs to be processed. There are several commands which are sent to the skinning routine of a widget, but only a set of commands is sent to a certain type of widget. Further the exact meaning may vary according to the widget. How to react to commands is explained in the widget specific sections of this chapter. The following table gives an overview of the commands which are sent to the skinning routines:

Command Id (Cmd)	Description
Creation messages	
WIDGET_ITEM_CREATE	Sent to each skinnable widget after it has been created but before it is drawn.
Information messages	
WIDGET_ITEM_GET_BORDERSIZE_B	Used to get the size of the bottom border.
WIDGET_ITEM_GET_BORDERSIZE_L	Used to get the size of the left border.
WIDGET_ITEM_GET_BORDERSIZE_R	Used to get the size of the right border.
WIDGET_ITEM_GET_BORDERSIZE_T	Used to get the size of the top border.
WIDGET_ITEM_GET_BUTTONSIZE	Used to get the button size.
WIDGET_ITEM_GET_XSIZE	Used to get the X-size.
WIDGET_ITEM_GET_YSIZE	Used to get the Y-size.
Drawing messages	
WIDGET_ITEM_DRAW_ARROW	Used to draw an arrow.
WIDGET_ITEM_DRAW_BACKGROUND	Used to draw the background.
WIDGET_ITEM_DRAW_BITMAP	Used to draw a bitmap.
WIDGET_ITEM_DRAW_BUTTON	Used to draw the button area.
WIDGET_ITEM_DRAW_BUTTON_L	Used to draw the left button area.
WIDGET_ITEM_DRAW_BUTTON_R	Used to draw the right button area.
WIDGET_ITEM_DRAW_FOCUS	Used to draw the focus rectangle.
WIDGET_ITEM_DRAW_FRAME	Used to draw the frame of a widget.
WIDGET_ITEM_DRAW_OVERLAP	Used to draw the overlapping region.
WIDGET_ITEM_DRAW_SEP	Used to draw a separator.
WIDGET_ITEM_DRAW_SHAFT	Used to draw the shaft area.
WIDGET_ITEM_DRAW_SHAFT_L	Used to draw the left shaft area.
WIDGET_ITEM_DRAW_SHAFT_R	Used to draw the right shaft area.
WIDGET_ITEM_DRAW_TEXT	Used to draw the text.
WIDGET_ITEM_DRAW_THUMB	Used to draw the thumb area.
WIDGET_ITEM_DRAW_TICKS	Used to draw tick marks.

## 7.4.7 General Skinning API

The table below lists available skinning-related routines in alphabetical order. These functions are common to all skinnable widgets, and are listed here in order to avoid repetition. Detailed descriptions of the routines follow. The additional skinning member functions available for each widget may be found in later sections.

Routine	Description
<code>&lt;WIDGET&gt;_DrawSkinFlex()</code>	Skinning callback function of the default skin.
<code>&lt;WIDGET&gt;_GetSkinFlexProps()</code>	Returns the current properties of the skin.
<code>&lt;WIDGET&gt;_SetDefaultSkin()</code>	Sets the default skin used for new widgets.
<code>&lt;WIDGET&gt;_SetDefaultSkinClassic()</code>	Sets the classical design as default for new widgets.
<code>&lt;WIDGET&gt;_SetSkin()</code>	Sets a skin for the given widget.
<code>&lt;WIDGET&gt;_SetSkinClassic()</code>	Sets the classical design for the given widget.
<code>&lt;WIDGET&gt;_SetSkinFlexProps()</code>	Sets the properties of the skin.

### 7.4.7.1 <WIDGET>\_DrawSkinFlex()

#### Description

These functions are the skinning callback functions of the default skin and are responsible to draw the complete widget.

#### Prototype

```
int <WIDGET>_DrawSkinFlex(const WIDGET_ITEM_DRAW_INFO * pDrawItemInfo);
```

#### Parameters

Parameter	Description
<code>pDrawItemInfo</code>	Pointer to a data structure of type <code>WIDGET_ITEM_DRAW_INFO</code> .

#### Additional information

A derived skin can use this function for drawing details of the default skin.



### 7.4.7.2 <WIDGET>\_GetSkinFlexProps()

#### Description

These functions return the attributes of the default skin. The widget specific descriptions later in this chapter explain the skin attributes in detail.

#### Prototype

```
void <WIDGET>_GetSkinFlexProps(<WIDGET>_SKINFLEX_PROPS * pProps,  
                             int Index);
```

#### Parameters

Parameter	Description
<code>pProps</code>	Pointer to a skin specific configuration structure of type <code>&lt;WIDGET&gt;_SKINFLEX_PROPS</code> to be filled by the function.
<code>Index</code>	Widget state (pressed, active, selected, ...) for which the details should be retrieved.

### 7.4.7.3 <WIDGET>\_SetDefaultSkin()

#### Description

These functions set the default skin which is used for new widgets of the dedicated type.

#### Prototype

```
void <WIDGET>_SetDefaultSkin(WIDGET_DRAW_ITEM_FUNC * pfDrawSkin);
```

#### Parameters

Parameter	Description
<code>pfDrawSkin</code>	Pointer to a skinning callback function of type <code>WIDGET_DRAW_ITEM_FUNC</code> .

#### Additional information

The given pointer should point to the skinning callback routine to be used for all new widgets. Details can be found in the description of `<WIDGET>_SetSkin()` on page 2812.

#### 7.4.7.4 <WIDGET>\_SetDefaultSkinClassic()

##### Description

These functions set the classical design for all new widgets of the dedicated type.

##### Prototype

```
void <WIDGET>_SetDefaultSkinClassic(void);
```

##### Additional information

The behavior of widgets which use the classical design is completely identical to the behavior before implementing the skinning feature.

### 7.4.7.5 <WIDGET>\_SetSkin()

#### Description

These functions can be used for setting a skin for the given widget.

#### Prototype

```
void <WIDGET>_SetSkin(<WIDGET>_Handle      hObj,  
                    WIDGET_DRAW_ITEM_FUNC * pfDrawSkin);
```

#### Parameters

Parameter	Description
<code>hObj</code>	Handle to the dedicated widget.
<code>pfDrawSkin</code>	Pointer to a skinning callback function of type <code>WIDGET_DRAW_ITEM_FUNC</code> .

#### WIDGET\_DRAW\_ITEM\_FUNC

```
typedef int WIDGET_DRAW_ITEM_FUNC(const WIDGET_ITEM_DRAW_INFO * pDrawItemInfo);
```

#### Additional information

Default widget API functions may have no effect in case a skin is used.

### 7.4.7.6 <WIDGET>\_SetSkinClassic()

#### Description

These functions switch to the classical design without skinning for the given widget.

#### Prototype

```
void <WIDGET>_SetSkinClassic(<WIDGET>_Handle hObj);
```

#### Parameters

Parameter	Description
<a href="#">hObj</a>	Handle to the dedicated widget.

#### Additional information

Additional information can be found in the description of `<WIDGET>_SetDefaultSkinClassic()` on page 2811.

### 7.4.7.7 <WIDGET>\_SetSkinFlexProps()

#### Description

With these functions some attributes of the default skin can be changed without deriving an own skin. The widget specific descriptions later in this chapter will explain in detail what can be changed.

#### Prototype

```
void <WIDGET>_SetSkinFlexProps(const <WIDGET>_SKINFLEX_PROPS * pProps,  
                               int Index);
```

#### Parameters

Parameter	Description
<code>pProps</code>	Pointer to a skin specific configuration structure of type <code>&lt;WIDGET&gt;_SKINFLEX_PROPS</code> .
<code>Index</code>	Details of the state (pressed, active, selected, ...) for which the details should be valid.

## 7.4.8 BUTTON\_SKIN\_FLEX

The following picture shows the details of the skin:



The BUTTON skin consists of a rounded border and a rectangular inner area which is filled by 2 gradients. The surrounding border is drawn by 2 colors.

Detail	Description
A	Top color of top gradient.
B	Bottom color of top gradient.
C	Top color of bottom gradient.
D	Bottom color of bottom gradient.
E	Outer color of surrounding frame.
F	Inner color of surrounding frame.
G	Color of area between surrounding frame and inner rectangular area.
R	Radius of rounded corner.
T	Optional text.

### 7.4.8.1 Configuration structure

To set up the default appearance of the skin or to change it at run time configuration structures of type `BUTTON_SKINFLEX_PROPS` are used:

#### Elements of structure `BUTTON_SKINFLEX_PROPS`

Data type	Element	Description
U32	<code>aColorFrame[3]</code>	[0] - Outer color of surrounding frame. [1] - Inner color of surrounding frame. [2] - Color of area between frame and inner area.
U32	<code>aColorUpper[2]</code>	[0] - First (upper) color of upper gradient. [1] - Second (lower) color of upper gradient.
U32	<code>aColorLower[2]</code>	[0] - First (upper) color of lower gradient. [1] - Second (lower) color of lower gradient.
int	<code>Radius</code>	Radius of rounded corner.

### 7.4.8.2 Configuration options

The default appearance of the skin can be defined using custom configuration structures of the type `BUTTON_SKINFLEX_PROPS` in `GUIConf.h`. The following table shows the identifiers which are used for the different states of the skinned `BUTTON` widget:

Macro	Description
<code>BUTTON_SKINPROPS_PRESSED</code>	Defines the default attributes used for pressed state.
<code>BUTTON_SKINPROPS_FOCUSED</code>	Defines the default attributes used for focused state.
<code>BUTTON_SKINPROPS_ENABLED</code>	Defines the default attributes used for enabled state.
<code>BUTTON_SKINPROPS_DISABLED</code>	Defines the default attributes used for disabled state.

### 7.4.8.3 Skinning API

The table below lists the available routines in alphabetical order:

Routine	Description
<code>BUTTON_DrawSkinFlex()</code>	Skinning callback function of <code>BUTTON_SKIN_FLEX</code> . (Explained at the beginning of the chapter)
<code>BUTTON_GetSkinFlexProps()</code>	Returns the properties of the given button skin. (Explained at the beginning of the chapter)
<code>BUTTON_SetDefaultSkin()</code>	Sets the default skin used for new button widgets. (Explained at the beginning of the chapter)
<code>BUTTON_SetDefaultSkinClassic()</code>	Sets the classical design as default for new button widgets. (Explained at the beginning of the chapter)
<code>BUTTON_SetSkin()</code>	Sets a skin for the given button widget. (Explained at the beginning of the chapter)
<code>BUTTON_SetSkinClassic()</code>	Sets the classical design for the given button widget. (Explained at the beginning of the chapter)
<code>BUTTON_SetSkinFlexProps()</code>	Sets the properties of the given button skin.



### 7.4.8.3.1 BUTTON\_SetSkinFlexProps()

Before	After
	

#### Description

Sets the properties of the given button skin.

#### Prototype

```
void BUTTON_SetSkinFlexProps(const BUTTON_SKINFLEX_PROPS * pProps,
                             int Index);
```

#### Parameters

Parameter	Description
<a href="#">pProps</a>	Pointer to a structure of type <code>BUTTON_SKINFLEX_PROPS</code> .
<a href="#">Index</a>	See table below.

Permitted values for parameter <a href="#">Index</a>	
<code>BUTTON_SKINFLEX_PI_PRESSED</code>	Properties for pressed state.
<code>BUTTON_SKINFLEX_PI_FOCUSED</code>	Properties for focused state.
<code>BUTTON_SKINFLEX_PI_ENABLED</code>	Properties for enabled state.
<code>BUTTON_SKINFLEX_PI_DISABLED</code>	Properties for disabled state.

#### Additional information

The function passes a pointer to a `BUTTON_SKINFLEX_PROPS` structure. It can be used to set up the colors and the radius of the skin.

## 7.4.8.4 List of commands

The skinning routine receives a pointer to a `WIDGET_ITEM_DRAW_INFO` structure. The `Cmd` member of this structure contains the command which needs to be processed. The following table shows all commands passed to the `BUTTON_SKIN_FLEX` callback function:

Command	Description
<code>WIDGET_ITEM_CREATE</code>	Is sent immediately after creating the widget.
<code>WIDGET_ITEM_DRAW_BACKGROUND</code>	The skinning function should draw the background.
<code>WIDGET_ITEM_DRAW_BITMAP</code>	The skinning function should draw the optional button bitmap.
<code>WIDGET_ITEM_DRAW_TEXT</code>	The skinning function should draw the optional button text.

The `WIDGET_ITEM_DRAW_INFO` structure is explained at the beginning of the chapter.

### 7.4.8.4.1 WIDGET\_ITEM\_CREATE

The skinning routine should, if necessary, set up skin related properties like e.g. transparency or text alignment.

### 7.4.8.4.2 WIDGET\_ITEM\_DRAW\_BACKGROUND

The background of the widget should be drawn.

#### Elements of structure `WIDGET_ITEM_DRAW_INFO`

Data type	Element	Description
<code>WM_HWIN</code>	<code>hWin</code>	Handle to the widget.
<code>int</code>	<code>ItemIndex</code>	See table below.
<code>int</code>	<code>x0</code>	Leftmost coordinate in window coordinates, normally 0.
<code>int</code>	<code>y0</code>	Topmost coordinate in window coordinates, normally 0.
<code>int</code>	<code>x1</code>	Rightmost coordinate in window coordinates.
<code>int</code>	<code>y1</code>	Bottommost coordinate in window coordinates.

Permitted values for element <code>ItemIndex</code>	
<code>BUTTON_SKINFLEX_PI_PRESSED</code>	The widget is pressed.
<code>BUTTON_SKINFLEX_PI_FOCUSED</code>	The widget is not pressed but focused.
<code>BUTTON_SKINFLEX_PI_ENABLED</code>	The widget is not focused but enabled.
<code>BUTTON_SKINFLEX_PI_DISABLED</code>	The widget is disabled.

### 7.4.8.4.3 WIDGET\_ITEM\_DRAW\_BITMAP

The optional button bitmap should be drawn.

#### `WIDGET_ITEM_DRAW_INFO`

A detailed description of the elements can be found under `WIDGET_ITEM_DRAW_BACKGROUND` on page 2818.

#### Additional information

The function `BUTTON_GetBitmap()` can be used to get the optional button bitmap.

#### 7.4.8.4.4 WIDGET\_ITEM\_DRAW\_TEXT

The optional button text should be drawn.

#### WIDGET\_ITEM\_DRAW\_INFO

A detailed description of the elements can be found under *WIDGET\_ITEM\_DRAW\_BACKGROUND* on page 2818.

#### Additional information

The function `BUTTON_GetText()` can be used to get the optional text.

### 7.4.9 CHECKBOX\_SKIN\_FLEX

The following picture shows the details of the skin:

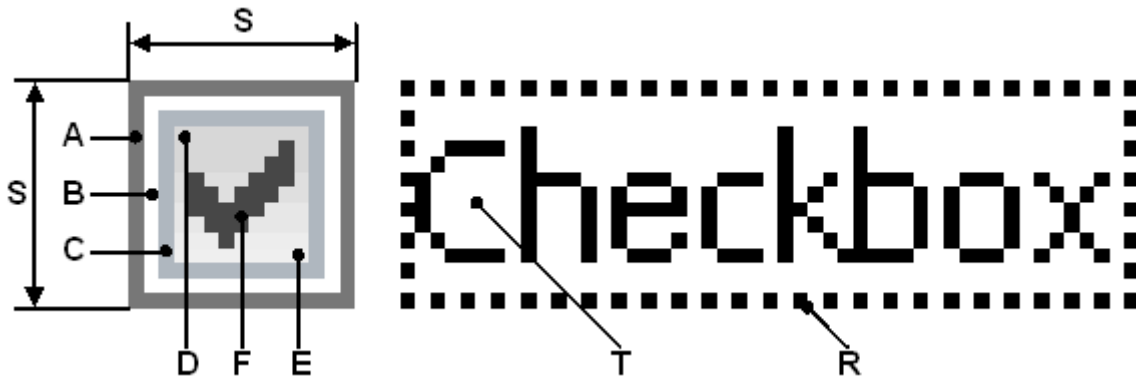

The button area of the CHECKBOX skin consists of a frame and a rectangular inner area which is filled by a gradient. The frame is drawn by 3 colors. If it is checked, a checkmark is shown in the center of the box:

Detail	Description
A	First color of frame.
B	Second color of frame.
C	Third color of frame.
D	Upper color of gradient.
E	Lower color of gradient.
F	Color of checkmark.
R	Focus rectangle.
S	Size in pixels of button area.
T	Optional text.

#### 7.4.9.1 Configuration structure

To set up the default appearance of the skin or to change it at run time configuration structures of type CHECKBOX\_SKINFLEX\_PROPS are used:

##### Elements of structure CHECKBOX\_SKINFLEX\_PROPS

Data type	Element	Description
U32	aColorFrame[3]	[0] - Outer color of frame. [1] - Middle color of frame. [2] - Inner color of frame.
U32	aColorInner[2]	[0] - First (upper) color of gradient. [1] - Second (lower) color of gradient.
U32	ColorCheck	Color of checkmark.
int	ButtonSize	Size in pixels of the button area. (Obsolete. Use the functions CHECKBOX_GetSkinFlexButtonSize() and CHECKBOX_SetSkinFlexButtonSize())

### 7.4.9.2 Configuration options

The default appearance of the skin can be determined by setting custom configuration structures of the above type in `GUIConf.h`. The following table shows the available configuration options:

Macro	Description
<code>CHECKBOX_SKINPROPS_ENABLED</code>	Defines the default attributes used for enabled state.
<code>CHECKBOX_SKINPROPS_DISABLED</code>	Defines the default attributes used for disabled state.

### 7.4.9.3 Skinning API

The table below lists the available routines in alphabetical order:

Routine	Description
<code>CHECKBOX_DrawSkinFlex()</code>	Skinning callback function of <code>CHECKBOX_SKIN_FLEX</code> . (Explained at the beginning of the chapter)
<code>CHECKBOX_GetSkinFlexButtonSize()</code>	Returns the button size of the specified <code>CHECKBOX</code> widget.
<code>CHECKBOX_GetSkinFlexProps()</code>	Returns the properties of the given checkbox skin. (Explained at the beginning of the chapter)
<code>CHECKBOX_SetDefaultSkin()</code>	Sets the default skin used for new checkbox widgets. (Explained at the beginning of the chapter)
<code>CHECKBOX_SetDefaultSkinClassic()</code>	Sets the classical design as default for new checkbox widgets. (Explained at the beginning of the chapter)
<code>CHECKBOX_SetSkin()</code>	Sets a skin for the given checkbox widget. (Explained at the beginning of the chapter)
<code>CHECKBOX_SetSkinClassic()</code>	Sets the classical design for the given checkbox widget. (Explained at the beginning of the chapter)
<code>CHECKBOX_SetSkinFlexButtonSize()</code>	Sets the button size of the specified <code>CHECKBOX</code> widget.
<code>CHECKBOX_SetSkinFlexProps()</code>	The function can be used to change the properties of the skin.

### 7.4.9.3.1 CHECKBOX\_GetSkinFlexButtonSize()

#### Description

Returns the button size of the specified CHECKBOX widget.

#### Prototype

```
int CHECKBOX_GetSkinFlexButtonSize(CHECKBOX_Handle hObj);
```

#### Parameters

Parameter	Description
<a href="#">hObj</a>	Handle to a CHECKBOX widget.

#### Return value

Button size.

### 7.4.9.3.2 CHECKBOX\_SetSkinFlexButtonSize()

Before	After
 Check	 Check

#### Description

Sets the button size of the specified CHECKBOX widget.

#### Prototype

```
void CHECKBOX_SetSkinFlexButtonSize(CHECKBOX_Handle hObj,
                                     int ButtonSize);
```

#### Parameters

Parameter	Description
<code>hObj</code>	Handle to a CHECKBOX widget.
<code>ButtonSize</code>	Size to be set.

### 7.4.9.3.3 CHECKBOX\_SetSkinFlexProps()

Before	After
 Check	 Check

#### Description

The function can be used to change the properties of the skin.

#### Prototype

```
void CHECKBOX_SetSkinFlexProps(const CHECKBOX_SKINFLEX_PROPS * pProps,
                               int Index);
```

#### Parameters

Parameter	Description
<code>pProps</code>	Pointer to a structure of type <code>CHECKBOX_SKINFLEX_PROPS</code> .
<code>Index</code>	See table below.

Permitted values for parameter <code>Index</code>	
<code>CHECKBOX_SKINFLEX_PI_ENABLED</code>	Properties for enabled state.
<code>CHECKBOX_SKINFLEX_PI_DISABLED</code>	Properties for disabled state.

#### Additional information

The function passes a pointer to a `CHECKBOX_SKINFLEX_PROPS` structure. It can be used to set up the colors of the skin. Please note that the size of the widgets using the skin won't be changed if for example the new button size is different to the old button size. This can not be done by the skin, because it does not 'know' which widget is using it. If required resizing should be done by the application, for example with `WM_ResizeWindow()`. The function `CHECKBOX_GetSkinFlexProps()` can be used to get the current attributes of the skin.



### 7.4.9.4 List of commands

The skinning routine receives a pointer to a `WIDGET_ITEM_DRAW_INFO` structure. The `Cmd` member of this structure contains the command which needs to be processed. The following table shows all commands passed to the `CHECKBOX_SKIN_FLEX` callback function:

Command	Description
<code>WIDGET_ITEM_CREATE</code>	Is sent immediately after creating the widget.
<code>WIDGET_ITEM_DRAW_BUTTON</code>	The background of the button area should be drawn.
<code>WIDGET_ITEM_DRAW_BITMAP</code>	The checkmark of the button area should be drawn.
<code>WIDGET_ITEM_DRAW_FOCUS</code>	The focus rectangle should be drawn.
<code>WIDGET_ITEM_DRAW_TEXT</code>	The optional text should be drawn.

#### 7.4.9.4.1 WIDGET\_ITEM\_CREATE

The skinning routine should, if necessary, set up skin related properties like e.g. transparency or text alignment.

#### 7.4.9.4.2 WIDGET\_ITEM\_DRAW\_BUTTON

The button area of the widget without checkmark should be drawn. It is typically drawn at the left side of the widget area.

#### Elements of structure `WIDGET_ITEM_DRAW_INFO`

Data type	Element	Description
<code>WM_HWIN</code>	<code>hWin</code>	Handle to the widget.
<code>int</code>	<code>x0</code>	Leftmost coordinate of widget area in window coordinates, normally 0.
<code>int</code>	<code>y0</code>	Topmost coordinate of widget area in window coordinates, normally 0.
<code>int</code>	<code>x1</code>	Rightmost coordinate of widget area in window coordinates.
<code>int</code>	<code>y1</code>	Bottommost coordinate of widget area in window coordinates.

The content of `hWin`, `x0`, `y0`, `x1` and `y1` is the same for all commands of this skin.

#### 7.4.9.4.3 WIDGET\_ITEM\_DRAW\_BITMAP

The checkmark should be drawn in the center of the button area.

#### Elements of structure `WIDGET_ITEM_DRAW_INFO`

Element	Description
<code>ItemIndex</code>	1 - The widget is checked. 2 - Second checked state when using a 3 state button.
<code>hWin, x0, y0, x1, y1</code>	These elements are described under <code>WIDGET_ITEM_DRAW_BUTTON</code> on page 2825.

#### 7.4.9.4.4 WIDGET\_ITEM\_DRAW\_FOCUS

The focus rectangle should be drawn around the text.

##### Elements of structure WIDGET\_ITEM\_DRAW\_INFO

Element	Description
p	The void pointer points to the zero terminated optional text of the widget.
hWin, x0, y0, x1, y1	These elements are described under <i>WIDGET_ITEM_DRAW_BUTTON</i> on page 2825.

##### Additional information

The element p can be casted to a text pointer. Details can be found in the description of *WIDGET\_ITEM\_DRAW\_TEXT* on page 2819.

#### 7.4.9.4.5 WIDGET\_ITEM\_DRAW\_TEXT

The optional text should be drawn. The text is typically drawn at the right side of the button area.

##### Elements of structure WIDGET\_ITEM\_DRAW\_INFO

Element	Description
p	The void pointer points to the zero terminated optional text of the widget.
hWin, x0, y0, x1, y1	These elements are described under <i>WIDGET_ITEM_DRAW_BUTTON</i> on page 2825.

##### Additional information

To get a text pointer the element p can be casted to a text pointer:

```
char * s;
s = (char *)pDrawItemInfo->p;
GUI_DispString(s);
```

### 7.4.10 DROPDOWN\_SKIN\_FLEX

The following picture shows the details of the skin:

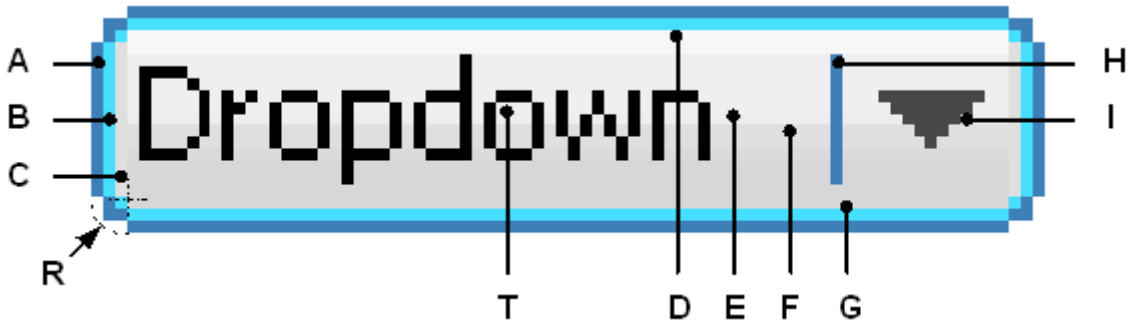

The DROPDOWN skin consists of a rounded frame and a rectangular inner area which is filled by two gradients. The rounded frame is drawn by 3 colors. At the right side a small triangle is drawn. Between text and triangle a small separator is drawn:

Detail	Description
A	First color of frame.
B	Second color of frame.
C	Third color of frame.
D	Top color of top gradient.
E	Bottom color of top gradient.
F	Top color of bottom gradient.
G	Bottom color of bottom gradient.
H	Separator between text and triangle.
I	Triangle.
R	Radius of rounded corner.
T	Optional text.

The dropdown widget in open state consists of an additional LISTBOX widget. The skin does not affect the LISTBOX.

#### 7.4.10.1 Configuration structure

To set up the default appearance of the skin or to change it at run time configuration structures of type `DROPDOWN_SKINFLEX_PROPS` are used:

##### Elements of structure `DROPDOWN_SKINFLEX_PROPS`

Data type	Element	Description
U32	aColorFrame[3]	[0] - Outer color of surrounding frame. [1] - Inner color of surrounding frame. [2] - Color of area between frame and inner area.
U32	aColorUpper[2]	[0] - Top color of top gradient. [1] - Bottom color of top gradient.
U32	aColorLower[2]	[0] - Top color of bottom gradient. [1] - Bottom color of bottom gradient.
U32	ColorArrow	Color used to draw the arrow.
U32	ColorText	Color used to draw the text.
U32	ColorSep	Color used to draw the separator.
int	Radius	Radius of rounded corner.

## 7.4.10.2 Configuration options

The default appearance of the skin can be determined by setting custom configuration structures of the above type in `GUIConf.h`. The following table shows the available configuration options:

Macro	Description
<code>DROPDOWN_SKINPROPS_OPEN</code>	Defines the default attributes used for open state.
<code>DROPDOWN_SKINPROPS_FOCUSED</code>	Defines the default attributes used for focused state.
<code>DROPDOWN_SKINPROPS_ENABLED</code>	Defines the default attributes used for enabled state.
<code>DROPDOWN_SKINPROPS_DISABLED</code>	Defines the default attributes used for disabled state.

## 7.4.10.3 Skinning API

The table below lists the available routines in alphabetical order:

Routine	Description
<code>DROPDOWN_DrawSkinFlex()</code>	Skinning callback function of <code>DROPDOWN_SKIN_FLEX</code> . (Explained at the beginning of the chapter)
<code>DROPDOWN_GetSkinFlexProps()</code>	Returns the properties of the given dropdown skin. (Explained at the beginning of the chapter)
<code>DROPDOWN_SetDefaultSkin()</code>	Sets the default skin used for new dropdown widgets. (Explained at the beginning of the chapter)
<code>DROPDOWN_SetDefaultSkinClassic()</code>	Sets the classical design as default for new dropdown widgets. (Explained at the beginning of the chapter)
<code>DROPDOWN_SetSkin()</code>	Sets a skin for the given dropdown widget. (Explained at the beginning of the chapter)
<code>DROPDOWN_SetSkinClassic()</code>	Sets the classical design for the given dropdown widget. (Explained at the beginning of the chapter)
<code>DROPDOWN_SetSkinFlexProps()</code>	The function can be used to change the properties of the skin.

### 7.4.10.3.1 DROPDOWN\_SetSkinFlexProps()

Before	After
	

#### Description

The function can be used to change the properties of the skin.

#### Prototype

```
void DROPDOWN_SetSkinFlexProps(const DROPDOWN_SKINFLEX_PROPS * pProps,
                               int Index);
```

#### Parameters

Parameter	Description
<code>pProps</code>	Pointer to a structure of type <code>DROPDOWN_SKINFLEX_PROPS</code> .
<code>Index</code>	See table below.

Permitted values for parameter <code>Index</code>	
<code>DROPDOWN_SKINFLEX_PI_OPEN</code>	Properties for open state.
<code>DROPDOWN_SKINFLEX_PI_FOCUSED</code>	Properties for focused state.
<code>DROPDOWN_SKINFLEX_PI_ENABLED</code>	Properties for enabled state.
<code>DROPDOWN_SKINFLEX_PI_DISABLED</code>	Properties for disabled state.

#### Additional information

The function passes a pointer to a `DROPDOWN_SKINFLEX_PROPS` structure. It can be used to set up the colors and the radius of the skin. The function `DROPDOWN_GetSkinFlexProps()` can be used to get the current attributes of the skin.

## 7.4.10.4 List of commands

The skinning routine receives a pointer to a `WIDGET_ITEM_DRAW_INFO` structure. The `Cmd` member of this structure contains the command which needs to be processed. The following table shows all commands passed to the `DROPDOWN_SKIN_FLEX` callback function:

Command	Description
<code>WIDGET_ITEM_CREATE</code>	Is sent immediately after creating the widget.
<code>WIDGET_ITEM_DRAW_ARROW</code>	The skinning function should draw the arrow.
<code>WIDGET_ITEM_DRAW_BACKGROUND</code>	The skinning function should draw the background.
<code>WIDGET_ITEM_DRAW_TEXT</code>	The skinning function should draw the optional button text.

### 7.4.10.4.1 WIDGET\_ITEM\_CREATE

The skinning routine should, if necessary, set up skin related properties like e.g. transparency or text alignment.

### 7.4.10.4.2 WIDGET\_ITEM\_DRAW\_ARROW

The triangle (arrow) at the right side should be drawn.

#### Elements of structure `WIDGET_ITEM_DRAW_INFO`

A detailed description of the elements can be found under `WIDGET_ITEM_DRAW_BACKGROUND` on page 2818.

### 7.4.10.4.3 WIDGET\_ITEM\_DRAW\_BACKGROUND

The background of the widget should be drawn.

#### Elements of structure `WIDGET_ITEM_DRAW_INFO`

Data type	Element	Description
<code>WM_HWIN</code>	<code>hWin</code>	Handle to the widget.
<code>int</code>	<code>ItemIndex</code>	See table below.
<code>int</code>	<code>x0</code>	Leftmost coordinate in window coordinates, normally 0.
<code>int</code>	<code>y0</code>	Topmost coordinate in window coordinates, normally 0.
<code>int</code>	<code>x1</code>	Rightmost coordinate in window coordinates.
<code>int</code>	<code>y1</code>	Bottommost coordinate in window coordinates.

#### Permitted values for element `ItemIndex`

<code>DROPDOWN_SKINFLEX_PI_EXPANDED</code>	The widget is expanded.
<code>DROPDOWN_SKINFLEX_PI_FOCUSED</code>	The widget is in not pressed but focused.
<code>DROPDOWN_SKINFLEX_PI_ENABLED</code>	The widget is in not focused but enabled.
<code>DROPDOWN_SKINFLEX_PI_DISABLED</code>	The widget is disabled.

### 7.4.10.4.4 WIDGET\_ITEM\_DRAW\_TEXT

The text of the currently selected string should be drawn within the button area of the dropdown widget. The text is typically drawn at the left side of the button area.

#### Elements of structure `WIDGET_ITEM_DRAW_INFO`

A detailed description of the elements can be found under `WIDGET_ITEM_DRAW_BACKGROUND` on page 2818.

### 7.4.11 FRAMEWIN\_SKIN\_FLEX

The following picture shows the details of the skin:

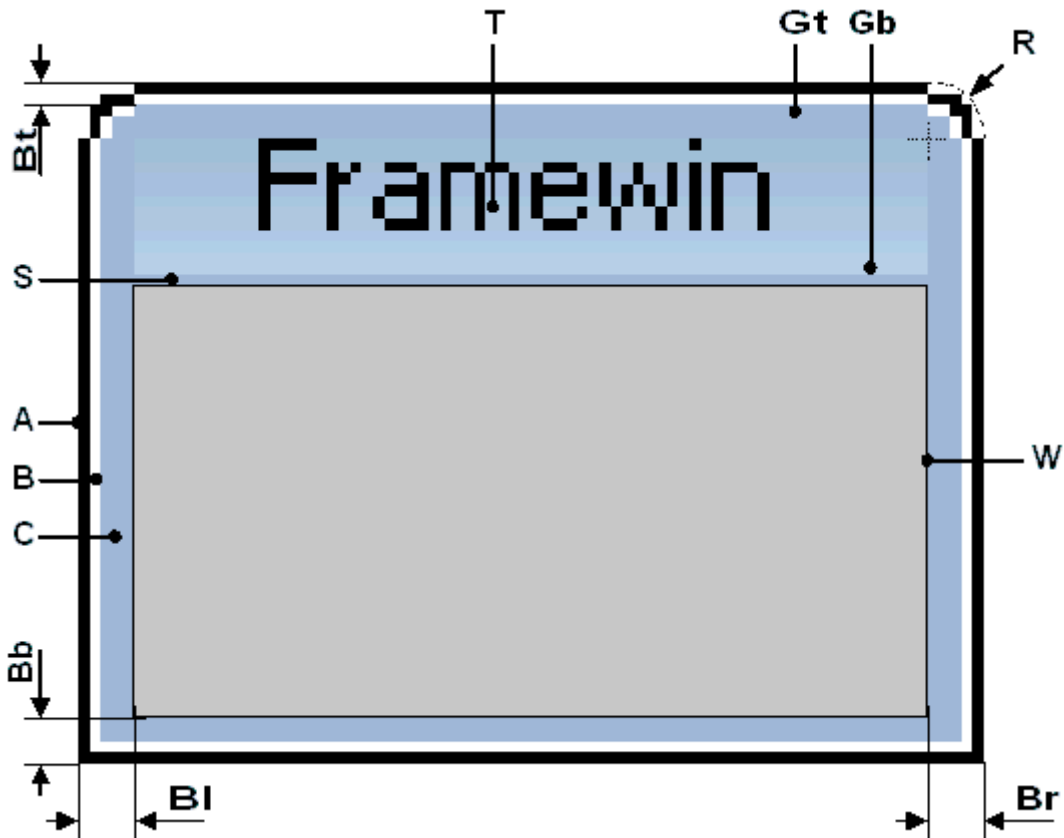

The FRAMEWIN skin consists of a title bar, rounded corners at the top, a gradient used to draw the background of the title bar, a border whose size is configurable and a separator between title bar and client area:

Detail	Description
A	Outer color of surrounding frame.
B	Inner color of surrounding frame.
C	Color of area between frame and inner area.
Gt	Top color of top title bar gradient.
Gb	Bottom color of title bar gradient.
Bt	Top size of border.
Bb	Bottom size of border.
Bl	Left size of border.
Br	Right size of border.
W	Area of client window.
R	Radius of rounded corner.
T	Optional text.

#### 7.4.11.1 Configuration structure

To set up the default appearance of the skin or to change it at run time configuration structures of type FRAMEWIN\_SKINFLEX\_PROPS are used:

## Elements of structure FRAMEWIN\_SKINFLEX\_PROPS

Data type	Element	Description
U32	aColorFrame[3]	[0] - Outer color of surrounding frame. [1] - Inner color of surrounding frame. [2] - Color of area between frame and inner area.
U32	aColorTitle[2]	[0] - Top color of top title bar gradient. [1] - Bottom color of title bar gradient.
int	Radius	Radius of rounded corners.
int	SpaceX	Optional space in X between title text and border of title gradient.
int	BorderSizeL	Left size of border.
int	BorderSizeR	Right size of border.
int	BorderSizeT	Top size of border.
int	BorderSizeB	Bottom size of border.

### 7.4.11.2 Configuration options

The default appearance of the skin can be determined by setting custom configuration structures of the above type in `GUIConf.h`. The following table shows the available configuration options:

Macro	Description
FRAMEWIN_SKINPROPS_ACTIVE	Defines the default attributes used for active state.
FRAMEWIN_SKINPROPS_INACTIVE	Defines the default attributes used for inactive state.

### 7.4.11.3 Skinning API

The table below lists the available routines in alphabetical order:

Routine	Description
<code>FRAMEWIN_DrawSkinFlex()</code>	Skinning callback function of <code>FRAMEWIN_SKIN_FLEX</code> . (Explained at the beginning of the chapter)
<code>FRAMEWIN_GetSkinFlexProps()</code>	Returns the properties of the given <code>FRAMEWIN</code> skin. (Explained at the beginning of the chapter)
<code>FRAMEWIN_SetDefaultSkin()</code>	Sets the default skin used for new framewin widgets. (Explained at the beginning of the chapter)
<code>FRAMEWIN_SetDefaultSkinClassic()</code>	Sets the classical design as default for new framewin widgets. (Explained at the beginning of the chapter)
<code>FRAMEWIN_SetSkin()</code>	Sets a skin for the given framewin widget. (Explained at the beginning of the chapter)
<code>FRAMEWIN_SetSkinClassic()</code>	Sets the classical design for the given framewin widget. (Explained at the beginning of the chapter)
<code>FRAMEWIN_SetSkinFlexProps()</code>	The function can be used to change the properties of the skin.



### 7.4.11.3.1 FRAMEWIN\_SetSkinFlexProps()



#### Description

The function can be used to change the properties of the skin.

#### Prototype

```
void FRAMEWIN_SetSkinFlexProps(const FRAMEWIN_SKINFLEX_PROPS * pProps,
                               int Index);
```

#### Parameters

Parameter	Description
<code>pProps</code>	Pointer to a structure of type <code>FRAMEWIN_SKINFLEX_PROPS</code> .
<code>Index</code>	See table below.

Permitted values for parameter <code>Index</code>	
<code>FRAMEWIN_SKINFLEX_PI_ACTIVE</code>	Properties for active state.
<code>FRAMEWIN_SKINFLEX_PI_INACTIVE</code>	Properties for inactive state.

#### Additional information

The function passes a pointer to a `FRAMEWIN_SKINFLEX_PROPS` structure. It can be used to set up the colors, radius and border size of the skin. The function `FRAMEWIN_GetSkinFlexProps()` can be used to get the current attributes of the skin. When creating a frame window using this skin the values for inactive state are used for calculating size and position of the client window.

### 7.4.11.4 List of commands

The skinning routine receives a pointer to a `WIDGET_ITEM_DRAW_INFO` structure. The `Cmd` member of this structure contains the command which needs to be processed. The following table shows all commands passed to the `FRAMEWIN_SKIN_FLEX` callback function:

Command	Description
<code>WIDGET_ITEM_CREATE</code>	Is sent immediately after creating the widget.
<code>WIDGET_ITEM_DRAW_BACKGROUND</code>	The skinning function should draw the title background.
<code>WIDGET_ITEM_DRAW_FRAME</code>	The skinning function should draw the frame.
<code>WIDGET_ITEM_DRAW_SEP</code>	The skinning function should draw the separator.
<code>WIDGET_ITEM_DRAW_TEXT</code>	The skinning function should draw the title text.
<code>WIDGET_ITEM_GET_BORDERSIZE_L</code>	The skinning function should return the left border size.
<code>WIDGET_ITEM_GET_BORDERSIZE_R</code>	The skinning function should return the right border size.
<code>WIDGET_ITEM_GET_BORDERSIZE_T</code>	The skinning function should return the top border size.
<code>WIDGET_ITEM_GET_BORDERSIZE_B</code>	The skinning function should return the bottom border size.
<code>WIDGET_ITEM_GET_RADIUS</code>	The skinning function should return the radius of the corners.

#### 7.4.11.4.1 WIDGET\_ITEM\_CREATE

The skinning routine should, if necessary, set up skin related properties like e.g. transparency or text alignment.

#### 7.4.11.4.2 WIDGET\_ITEM\_DRAW\_BACKGROUND

The skinning routine should draw the background of the title area.

#### Elements of structure `WIDGET_ITEM_DRAW_INFO`

Data type	Element	Description
<code>WM_HWIN</code>	<code>hWin</code>	Handle to the widget.
<code>int</code>	<code>ItemIndex</code>	See table below.
<code>int</code>	<code>x0</code>	Leftmost coordinate of title area in window coordinates.
<code>int</code>	<code>y0</code>	Topmost coordinate of title area in window coordinates.
<code>int</code>	<code>x1</code>	Rightmost coordinate of title area in window coordinates.
<code>int</code>	<code>y1</code>	Bottommost coordinate of title area in window coordinates.

Permitted values for element `ItemIndex`

<code>FRAMEWIN_SKINFLEX_PI_ACTIVE</code>	The widget is in active state.
<code>FRAMEWIN_SKINFLEX_PI_INACTIVE</code>	The widget is in inactive state.

### 7.4.11.4.3 WIDGET\_ITEM\_DRAW\_FRAME

The skinning routine should draw the complete border without the title area and the separator.

#### Elements of structure WIDGET\_ITEM\_DRAW\_INFO

Data type	Element	Description
WM_HWIN	hWin	Handle to the widget.
int	ItemIndex	See table below.
int	x0	Leftmost coordinate in window coordinates, normally 0.
int	y0	Topmost coordinate in window coordinates, normally 0.
int	x1	Rightmost coordinate in window coordinates (xSize of window - 1).
int	y1	Bottommost coordinate in window coordinates (ySize of window - 1).

#### Permitted values for element ItemIndex

FRAMEWIN_SKINFLEX_PI_ACTIVE	The widget is in active state.
FRAMEWIN_SKINFLEX_PI_INACTIVE	The widget is in inactive state.

### 7.4.11.4.4 WIDGET\_ITEM\_DRAW\_TEXT

The skinning routine should draw title text.

#### Elements of structure WIDGET\_ITEM\_DRAW\_INFO

A detailed description of the elements can be found under *WIDGET\_ITEM\_DRAW\_BACKGROUND* on page 2818.

### 7.4.11.4.5 WIDGET\_ITEM\_GET\_BORDERSIZE\_L

### 7.4.11.4.6 WIDGET\_ITEM\_GET\_BORDERSIZE\_R

### 7.4.11.4.7 WIDGET\_ITEM\_GET\_BORDERSIZE\_T

### 7.4.11.4.8 WIDGET\_ITEM\_GET\_BORDERSIZE\_B

The skinning routine should return the size of the according border.

### 7.4.12 HEADER\_SKIN\_FLEX

The following picture shows the details of the skin:

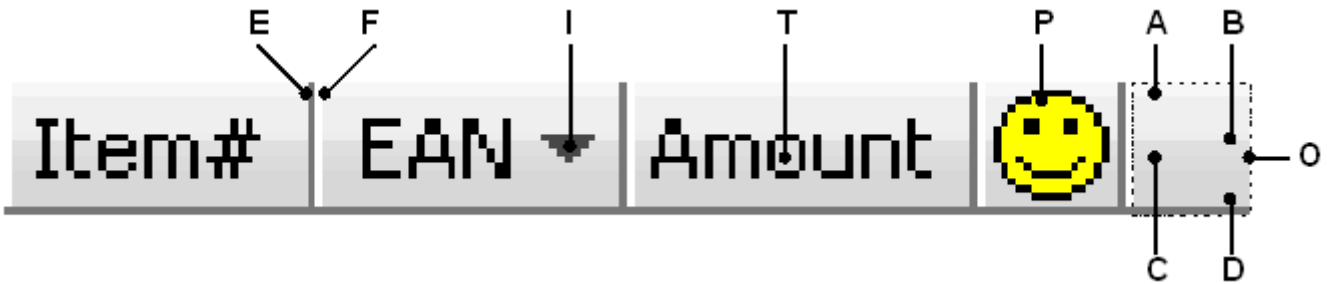

The HEADER skin consists of a bar with a thin border which is divided into separate items. The background of the bar consists of a top and a bottom gradient. Each item can have a text, a bitmap and an indicator which can be used for example to show the sorting order:

Detail	Description
A	Top color of top gradient.
B	Bottom color of top gradient.
C	Top color of bottom gradient.
D	Bottom color of bottom gradient.
E	First color of frame.
F	Second color of frame.
I	Indicator.
T	Text (optional).
P	Bitmap (optional).

#### 7.4.12.1 Configuration structure

To set up the default appearance of the skin or to change it at run time configuration structures of type `HEADER_SKINFLEX_PROPS` are used:

##### Elements of structure `HEADER_SKINFLEX_PROPS`

Data type	Element	Description
U32	<code>aColorFrame[2]</code>	[0] - First color of frame and separators. [1] - Second color of frame and separators.
U32	<code>aColorUpper[2]</code>	[0] - Top color of top gradient. [1] - Bottom color of top gradient.
U32	<code>aColorLower[2]</code>	[0] - Top color of bottom gradient. [1] - Bottom color of bottom gradient.
U32	<code>ColorArrow</code>	Color of indicator.

#### 7.4.12.2 Configuration options

The default appearance of the skin can be determined by setting custom configuration structures of the above type in `GUIConf.h`. The following table shows the available configuration options:



Macro	Description
<code>HEADER_SKINPROPS</code>	Defines the default attributes used for drawing the skin.

### 7.4.12.3 Skinning API

The table below lists the available routines in alphabetical order:

Routine	Description
<code>HEADER_DrawSkinFlex()</code>	Skinning callback function of <code>HEADER_SKIN_FLEX</code> . (Explained at the beginning of the chapter)
<code>HEADER_GetSkinFlexProps()</code>	Returns the properties of the given <code>HEADER</code> skin. (Explained at the beginning of the chapter)
<code>HEADER_SetDefaultSkin()</code>	Sets the default skin used for new <code>HEADER</code> widgets. (Explained at the beginning of the chapter)
<code>HEADER_SetDefaultSkinClassic()</code>	Sets the classical design as default for new <code>HEADER</code> widgets. (Explained at the beginning of the chapter)
<code>HEADER_SetSkin()</code>	Sets a skin for the given <code>HEADER</code> widget. (Explained at the beginning of the chapter)
<code>HEADER_SetSkinClassic()</code>	Sets the classical design for the given <code>HEADER</code> widget. (Explained at the beginning of the chapter)
<code>HEADER_SetSkinFlexProps()</code>	The function can be used to change the properties of the skin.

### 7.4.12.3.1 HEADER\_SetSkinFlexProps()

Before	After
	

#### Description

The function can be used to change the properties of the skin.

#### Prototype

```
void HEADER_SetSkinFlexProps(const HEADER_SKINFLEX_PROPS * pProps,
                             int Index);
```

#### Parameters

Parameter	Description
<code>pProps</code>	Pointer to a structure of type <code>HEADER_SKINFLEX_PROPS</code> .
<code>Index</code>	See table below.

#### Additional information

The function passes a pointer to a `HEADER_SKINFLEX_PROPS` structure. It can be used to set up the colors of the skin. The function `HEADER_GetSkinFlexProps()` can be used to get the current attributes of the skin.

## 7.4.12.4 List of commands

The skinning routine receives a pointer to a `WIDGET_ITEM_DRAW_INFO` structure. The `Cmd` member of this structure contains the command which needs to be processed. The following table shows all commands passed to the `HEADER_SKIN_FLEX` callback function:

Command	Description
<code>WIDGET_ITEM_CREATE</code>	Is sent immediately after creating the widget.
<code>WIDGET_ITEM_DRAW_ARROW</code>	The indicator arrow of the header item should be drawn.
<code>WIDGET_ITEM_DRAW_BACKGROUND</code>	The background of the header item should be drawn.
<code>WIDGET_ITEM_DRAW_BITMAP</code>	The bitmap of the header item should be drawn.
<code>WIDGET_ITEM_DRAW_OVERLAP</code>	The overlapping region of the widget should be drawn.
<code>WIDGET_ITEM_DRAW_TEXT</code>	The text of the header item should be drawn.

### 7.4.12.4.1 WIDGET\_ITEM\_CREATE

The skinning routine should, if necessary, set up skin related properties like e.g. transparency or text alignment.

### 7.4.12.4.2 WIDGET\_ITEM\_DRAW\_ARROW

The skinning routine should draw the optional direction indicator. This message is sent only if the indicator of the header item is enabled.

#### Elements of structure `WIDGET_ITEM_DRAW_INFO`

A detailed description of the elements can be found under `WIDGET_ITEM_DRAW_BACKGROUND` on page 2818.

### 7.4.12.4.3 WIDGET\_ITEM\_DRAW\_BACKGROUND

The skinning routine should draw the background of an item area.

#### Elements of structure `WIDGET_ITEM_DRAW_INFO`

Data type	Element	Description
<code>WM_HWIN</code>	<code>hWin</code>	Handle to the widget.
<code>int</code>	<code>ItemIndex</code>	Is always 0.
<code>int</code>	<code>x0</code>	Leftmost coordinate of item area in window coordinates.
<code>int</code>	<code>y0</code>	Topmost coordinate of item area in window coordinates.
<code>int</code>	<code>x1</code>	Rightmost coordinate of item area in window coordinates.
<code>int</code>	<code>y1</code>	Bottommost coordinate of item area in window coordinates.

### 7.4.12.4.4 WIDGET\_ITEM\_DRAW\_BITMAP

The skinning routine should draw the optional item bitmap. The message is only sent in case of an existing bitmap.

#### Elements of structure `WIDGET_ITEM_DRAW_INFO`

A detailed description of the elements can be found under `WIDGET_ITEM_DRAW_BACKGROUND` on page 2818.

#### 7.4.12.4.5 WIDGET\_ITEM\_DRAW\_OVERLAP

The skinning routine should draw the overlapping region.

##### **Elements of structure WIDGET\_ITEM\_DRAW\_INFO**

A detailed description of the elements can be found under *WIDGET\_ITEM\_DRAW\_BACKGROUND* on page 2818.

#### 7.4.12.4.6 Widget\_ITEM\_DRAW\_TEXT

The skinning routine should draw the optional item text. The message is only sent in case of an existing text.

##### **Elements of structure WIDGET\_ITEM\_DRAW\_INFO**

A detailed description of the elements can be found under *WIDGET\_ITEM\_DRAW\_BACKGROUND* on page 2818.



### 7.4.13 MENU\_SKIN\_FLEX

The following picture shows the details of the skin:

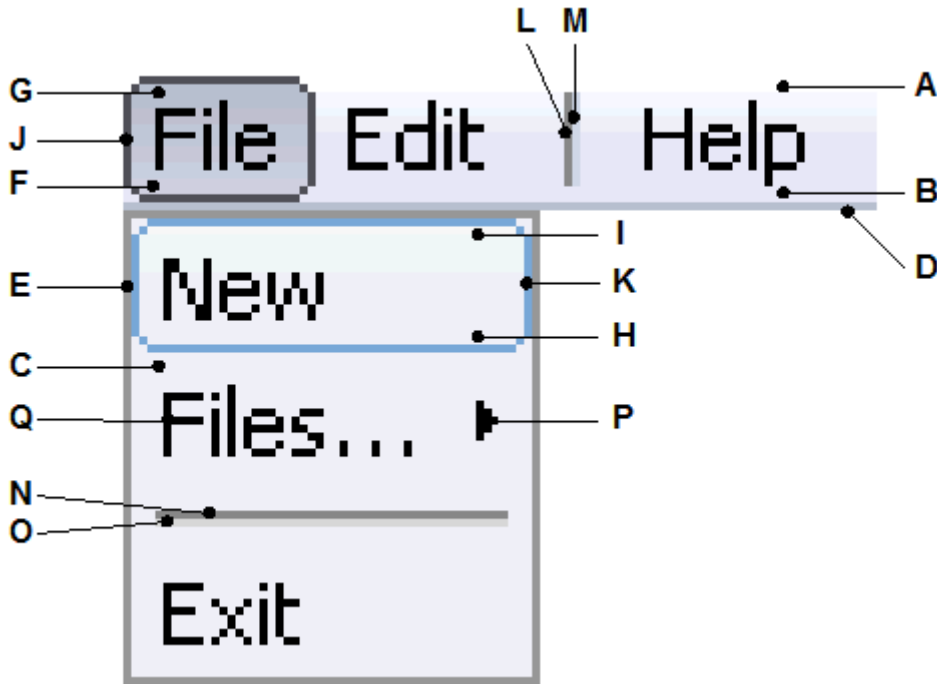

The MENU skin covers horizontal as well as vertical MENU widgets. Since both variations require the ability to be handled differently, most items can be colored separately. The background is drawn by a gradient for horizontal MENU widgets. The vertical version only consists of a single background color. Selected and selected items having a submenu are drawn using a gradient and a frame. All vertical items are surrounded by a frame. Horizontal items are just underlined. Vertical items with a submenu consist of an arrow indicating the submenu. Separators are drawn using 2 lines with 2 different colors. The item text is displayed using the same color for all items.

Detail	Description
A	Top color of the background gradient. (horizontal)
B	Bottom color of the background gradient. (horizontal)
C	Background color. (vertical)
D	Frame color. (horizontal)
E	Frame color. (vertical)
F	Bottom color of the background gradient for selected items. (horizontal)
G	Top color of the background gradient for selected items. (horizontal)
H	Bottom color of the background gradient for selected items. (vertical)
I	Top color of the background gradient for selected items. (vertical)
J	Frame color for selected items. (horizontal)
K	Frame color for selected items. (vertical)
L	Left separator color. (horizontal)
M	Right separator color. (horizontal)
N	Top separator color. (vertical)
O	Bottom separator color. (vertical)
P	Color of the arrow indicating submenus.
Q	Color of the text.

### 7.4.13.1 Configuration structure

To set up the default appearance of the skin or to change it at run time configuration a structure of the type `MENU_SKINFLEX_PROPS` must be used:

#### Elements of structure `MENU_SKINFLEX_PROPS`

Data type	Element	Description
Background		
U32	<code>aBkColorH[2]</code>	Horizontal: [0] - Top color of background gradient. [1] - Bottom color of horizontal background gradient.
U32	<code>BkColorV</code>	Background color. (vertical)
U32	<code>FrameColorH</code>	Frame color. (horizontal)
U32	<code>FrameColorV</code>	Frame color. (vertical)
Selection		
U32	<code>aSelColorH[2]</code>	Horizontal: [0] - Top color of the background gradient for selected items. [1] - Bottom color of the background gradient for selected items.
U32	<code>aSelColorV[2]</code>	Vertical: [0] - Top color of the background gradient for selected items. [1] - Bottom color of the background gradient for selected items.
U32	<code>FrameColorSelH</code>	Frame color for selected items. (horizontal)
U32	<code>FrameColorSelV</code>	Frame color for selected items. (vertical)
Separator		
U32	<code>aSepColorH[2]</code>	Horizontal: [0] - Left separator color. [1] - Right separator color.
U32	<code>aSepColorV[2]</code>	Vertical: [0] - Top separator color. [1] - Bottom separator color.
General		
U32	<code>ArrowColor</code>	Color of the arrow indicating submenus.
U32	<code>TextColor</code>	Color of the text.

### 7.4.13.2 Configuration options

The default appearance of the skin can be determined by setting custom configuration structures of the above type in `GUIConf.h`. The following table shows the available configuration options:

Macro	Description
<code>MENU_SKINPROPS_ACTIVE_SUBMENU</code>	Defines the default attributes which are used to draw the item in case its submenu is active.
<code>MENU_SKINPROPS_DISABLED</code>	Defines the default attributes which are used to draw the item in disabled state.
<code>MENU_SKINPROPS_DISABLED_SEL</code>	Defines the default attributes which are used to draw the item in case it is selected in disabled state.
<code>MENU_SKINPROPS_ENABLED</code>	Defines the default attributes which are used to draw the item in enabled state.
<code>MENU_SKINPROPS_SELECTED</code>	Defines the default attributes which are used to draw the item in selected state.

### 7.4.13.3 Skinning API

The table below lists the available routines in alphabetical order:

Routine	Description
<code>MENU_DrawSkinFlex()</code>	Skinning callback function of <code>MENU_SKIN_FLEX</code> . (Explained at the beginning of the chapter)
<code>MENU_GetSkinFlexProps()</code>	Returns the properties of the given <code>MENU</code> skin. (Explained at the beginning of the chapter)
<code>MENU_SetDefaultSkin()</code>	Sets the default skin used for new <code>MENU</code> widgets. (Explained at the beginning of the chapter)
<code>MENU_SetDefaultSkinClassic()</code>	Sets the classical design as default for new <code>MENU</code> widgets. (Explained at the beginning of the chapter)
<code>MENU_SetSkin()</code>	Sets a skin for the given <code>MENU</code> widget. (Explained at the beginning of the chapter)
<code>MENU_SetSkinClassic()</code>	Sets the classical design for the given <code>MENU</code> widget. (Explained at the beginning of the chapter)
<code>MENU_SetSkinFlexProps()</code>	The function can be used to change the colors of the skin.
<code>MENU_SkinEnableArrow()</code>	Toggles the drawing of an arrow.

### 7.4.13.3.1 MENU\_SetSkinFlexProps()

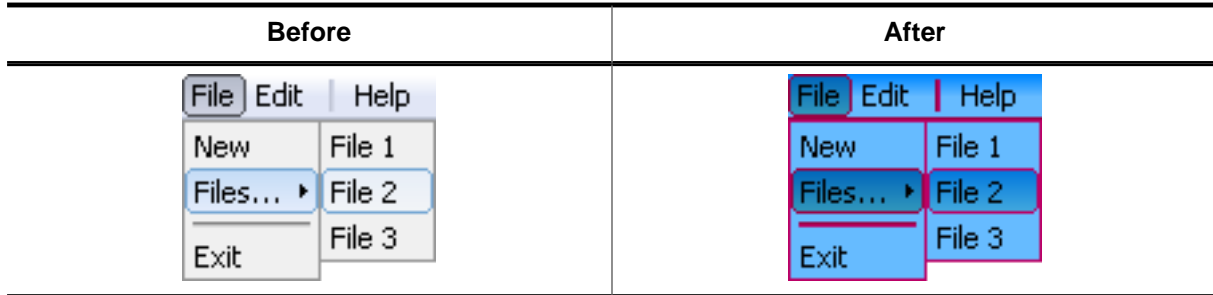

#### Description

The function can be used to change the colors of the skin.

#### Prototype

```
void MENU_SetSkinFlexProps(const MENU_SKINFLEX_PROPS * pProps,
                          int Index);
```

#### Parameters

Parameter	Description
<a href="#">pProps</a>	Pointer to a structure of type MENU_SKINFLEX_PROPS.
<a href="#">Index</a>	See table below.

Permitted values for parameter <a href="#">Index</a>	
MENU_SKINFLEX_PI_ENABLED	Properties for enabled state.
MENU_SKINFLEX_PI_SELECTED	Properties for selected state.
MENU_SKINFLEX_PI_DISABLED	Properties for disabled state.
MENU_SKINFLEX_PI_DISABLED_SEL	Properties for disabled selected state.
MENU_SKINFLEX_PI_ACTIVE_SUBMENU	Properties for active submenu state.

#### Additional information

The function passes a pointer to a MENU\_SKINFLEX\_PROPS structure. It can be used to set up the colors of the skin. The function *MENU\_GetSkinFlexProps()* can be used to get the current attributes of the skin.

### 7.4.13.3.2 MENU\_SkinEnableArrow()

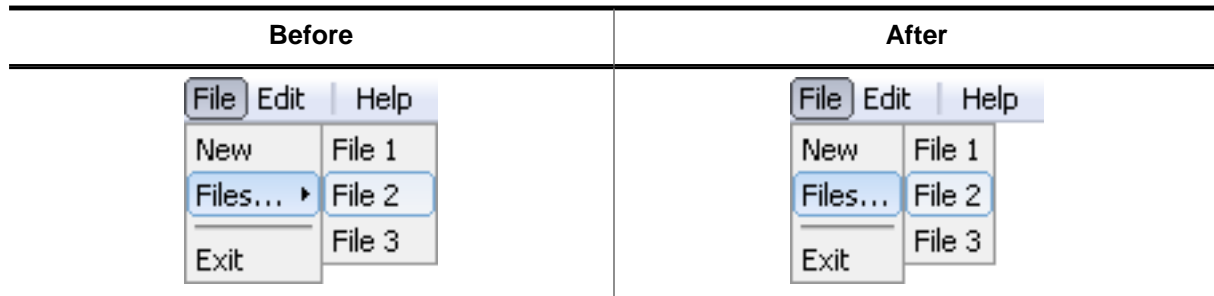

#### Description

Toggles the drawing of an arrow.

#### Prototype

```
void MENU_SkinEnableArrow(MENU_Handle hObj,
                          int         OnOff);
```

#### Parameters

Parameter	Description
<code>hObj</code>	Handle the MENU widget.
<code>OnOff</code>	1 to enable drawing of arrows. 0 to disable drawing of arrows.

#### Additional information

Arrows are drawn only...

- ...if the item is part of a vertical MENU widget.
- ...if the item consists of a submenu.
- ...if drawing of arrows is enabled using this function.

### 7.4.13.4 List of commands

The skinning routine receives a pointer to a `WIDGET_ITEM_DRAW_INFO` structure. The `Cmd` member of this structure contains the command which needs to be processed. The following table shows all commands passed to the `MENU_SKIN_FLEX` callback function:

Command	Description
<code>WIDGET_ITEM_CREATE</code>	Is sent immediately after creating the widget.
<code>WIDGET_ITEM_DRAW_ARROW</code>	The skinning function should draw the arrow.
<code>WIDGET_ITEM_DRAW_BACKGROUND</code>	The skinning function should draw the background.
<code>WIDGET_ITEM_DRAW_FRAME</code>	The skinning function should draw the frame.
<code>WIDGET_ITEM_DRAW_SEP</code>	The skinning function should draw the separator.
<code>WIDGET_ITEM_DRAW_TEXT</code>	The skinning function should draw the text.

#### 7.4.13.4.1 WIDGET\_ITEM\_CREATE

The skinning routine should, if necessary, set up skin related properties like e.g. transparency or text alignment.

#### 7.4.13.4.2 WIDGET\_ITEM\_DRAW\_ARROW

The skinning routine should draw the arrow.

#### Elements of structure `WIDGET_ITEM_DRAW_INFO`

Data type	Element	Description
<code>WM_HWIN</code>	<code>hWin</code>	Handle to the widget.
<code>int</code>	<code>ItemIndex</code>	Index of the according item ( $\geq 0$ ).
<code>int</code>	<code>x0</code>	Leftmost coordinate of the item area in window coordinates.
<code>int</code>	<code>y0</code>	Topmost coordinate of the item area in window coordinates.
<code>int</code>	<code>x1</code>	Rightmost coordinate of the item area in window coordinates.
<code>int</code>	<code>y1</code>	Bottommost coordinate of the item area in window coordinates.

#### Additional information

This message is sent only in case drawing arrows is enabled. Drawing is enabled by default when using `MENU_SKIN_FLEX`. Detailed information on how to enable/disable drawing of arrows can be found in the description of the function `MENU_SkinEnableArrow` on page 2845.

#### Additional information

This message is sent only in case drawing arrows is enabled. Drawing is enabled by default when using `MENU_SKIN_FLEX`. Detailed information on how to enable/disable drawing of arrows can be found in the description of the function `MENU_SkinEnableArrow` on page 2845.

### 7.4.13.4.3 WIDGET\_ITEM\_DRAW\_BACKGROUND

The skinning routine should draw the background.

#### Elements of structure WIDGET\_ITEM\_DRAW\_INFO

Data type	Element	Description
WM_HWIN	hWin	Handle to the widget.
int	ItemIndex	Index of the according item ( $\geq 0$ ) or -1.
int	x0	Leftmost coordinate of the item area in window coordinates.
int	y0	Topmost coordinate of the item area in window coordinates.
int	x1	Rightmost coordinate of the item area in window coordinates.
int	y1	Bottommost coordinate of the item area in window coordinates.

#### Additional information

This message is sent once per each item of the MENU widget. In case a horizontal MENU widget is not completely covered by items, `WIDGET_ITEM_DRAW_BACKGROUND` is sent one more time with `ItemIndex = -1` and the coordinates of the unused area right of the last item.

### 7.4.13.4.4 WIDGET\_ITEM\_DRAW\_FRAME

The skinning routine should draw the surrounding frame.

#### Elements of structure WIDGET\_ITEM\_DRAW\_INFO

See `WIDGET_ITEM_DRAW_ARROW` on page 2830.

### 7.4.13.4.5 WIDGET\_ITEM\_DRAW\_TEXT

The skinning routine should draw the text.

#### Elements of structure WIDGET\_ITEM\_DRAW\_INFO

See `WIDGET_ITEM_DRAW_ARROW` on page 2830.

### 7.4.14 MULTIPAGE\_SKIN\_FLEX

The following picture shows the details of the skin:

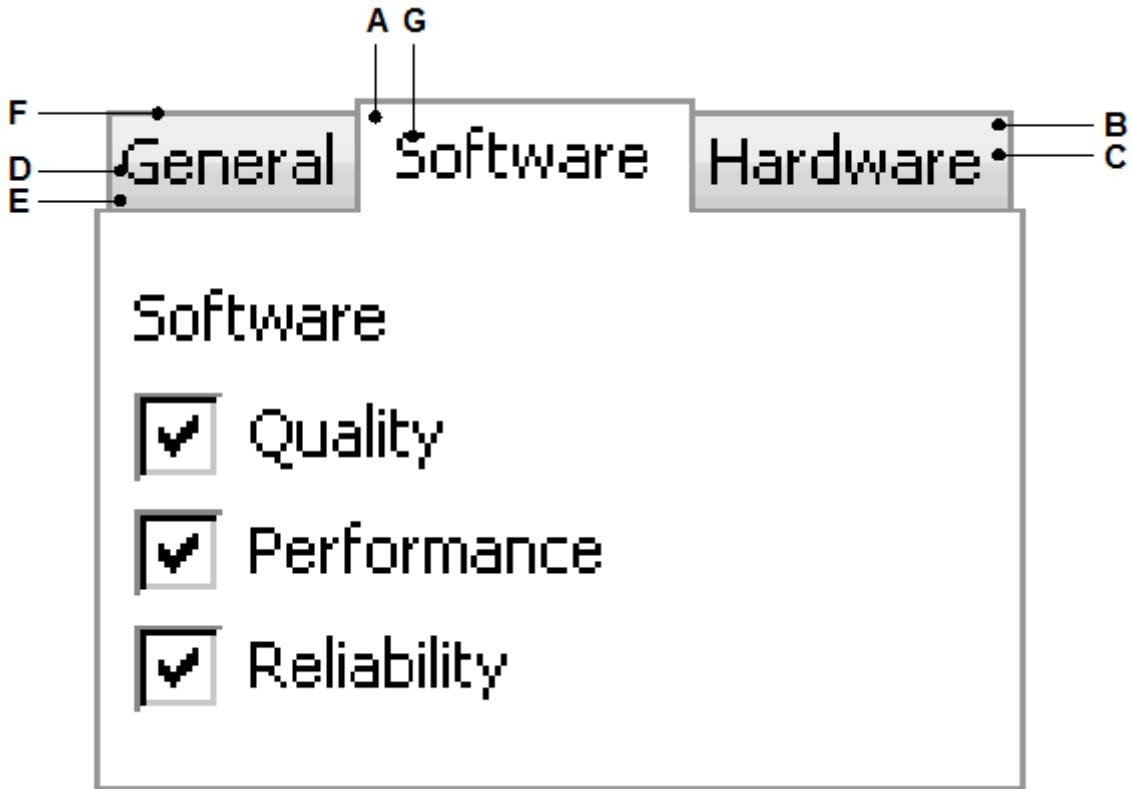

The MULTIPAGE skin consists of the tabs which are drawn using a frame and 2 horizontal gradients as background. The according text is displayed on top of the background:

Detail	Description
A	Background color for selected items.
B	Top color of top gradient.
C	Bottom color of top gradient.
D	Top color of bottom gradient.
E	Bottom color of bottom gradient.
F	Frame color.
G	Text color.

#### 7.4.14.1 Configuration structure

To set up the default appearance of the skin or to change it at run time configuration structures of type MULTIPAGE\_SKINFLEX\_PROPS are used:

##### Elements of structure MULTIPAGE\_SKINFLEX\_PROPS

Data type	Element	Description
U32	BkColor	Background color for selected items.
U32	aBkUpper[2]	[0] - Top color of top gradient. [1] - Bottom color of top gradient.
U32	aBkLower[2]	[0] - Top color of bottom gradient. [1] - Bottom color of bottom gradient.
U32	FrameColor	Frame color.
U32	TextColor	Text color.



### 7.4.14.2 Configuration options

The default appearance of the skin can be determined by setting custom configuration structures of the above type in `GUIConf.h`. The following table shows the available configuration options:

Macro	Description
<code>MULTIPAGE_SKINPROPS_ENABLED</code>	Defines the default attributes for drawing enabled tabs.
<code>MULTIPAGE_SKINPROPS_SELECTED</code>	Defines the default attributes for drawing selected tabs.
<code>MULTIPAGE_SKINPROPS_DISABLED</code>	Defines the default attributes for drawing disabled tabs.

### 7.4.14.3 Skinning API

The table below lists the available routines in alphabetical order:

Routine	Description
<code>MULTIPAGE_DrawSkinFlex()</code>	Skinning callback function of <code>MULTIPAGE_SKIN_FLEX</code> . (Explained at the beginning of the chapter)
<code>MULTIPAGE_GetSkinFlexProps()</code>	Returns the properties of the given <code>MULTIPAGE</code> skin. (Explained at the beginning of the chapter)
<code>MULTIPAGE_SetDefaultSkin()</code>	Sets the default skin used for new <code>MULTIPAGE</code> widgets. (Explained at the beginning of the chapter)
<code>MULTIPAGE_SetDefaultSkinClassic()</code>	Sets the classical design as default for new <code>MULTIPAGE</code> widgets. (Explained at the beginning of the chapter)
<code>MULTIPAGE_SetSkin()</code>	Sets a skin for the given <code>MULTIPAGE</code> widget. (Explained at the beginning of the chapter)
<code>MULTIPAGE_SetSkinClassic()</code>	Sets the classical design for the given <code>MULTIPAGE</code> widget. (Explained at the beginning of the chapter)
<code>MULTIPAGE_SetSkinFlexProps()</code>	The function can be used to change the colors of the skin.

### 7.4.14.3.1 MULTIPAGE\_SetSkinFlexProps()

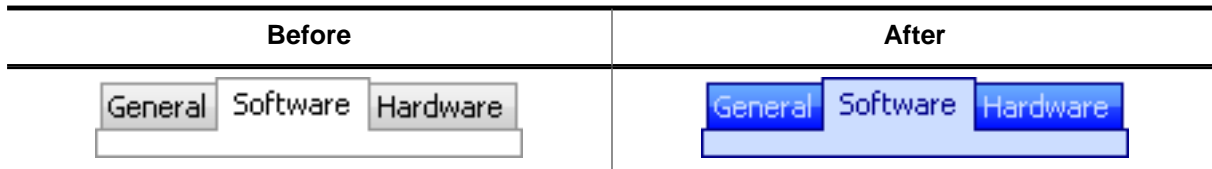

#### Description

The function can be used to change the colors of the skin.

#### Prototype

```
void MULTIPAGE_SetSkinFlexProps(const MULTIPAGE_SKINFLEX_PROPS * pProps,
                               int Index);
```

#### Parameters

Parameter	Description
<code>pProps</code>	Pointer to a structure of type <code>MULTIPAGE_SKINFLEX_PROPS</code> .
<code>Index</code>	See table below.

Permitted values for parameter <code>Index</code>	
<code>MULTIPAGE_SKINFLEX_PI_ENABLED</code>	Properties for enabled state.
<code>MULTIPAGE_SKINFLEX_PI_SELECTED</code>	Properties for selected state.
<code>MULTIPAGE_SKINFLEX_PI_DISABLED</code>	Properties for disabled state.

#### Additional information

The function passes a pointer to a `MULTIPAGE_SKINFLEX_PROPS` structure. It can be used to set up the colors of the skin. The function `MULTIPAGE_GetSkinFlexProps()` can be used to get the current attributes of the skin.

### 7.4.14.4 List of commands

The skinning routine receives a pointer to a `WIDGET_ITEM_DRAW_INFO` structure. The `Cmd` member of this structure contains the command which needs to be processed. The following table shows all commands passed to the `MULTIPAGE_SKIN_FLEX` callback function:

Command	Description
<code>WIDGET_ITEM_CREATE</code>	Is sent immediately after creating the widget.
<code>WIDGET_ITEM_DRAW_BACKGROUND</code>	The skinning function should draw the background.
<code>WIDGET_ITEM_DRAW_FRAME</code>	The skinning function should draw the frame.
<code>WIDGET_ITEM_DRAW_TEXT</code>	The skinning function should draw the text.

All commands make use of the `WIDGET_ITEM_DRAW_INFO` structure, which contains the required information to draw the widget using a skin.

#### Elements of structure `WIDGET_ITEM_DRAW_INFO`

Data type	Element	Description
<code>WM_HWIN</code>	<code>hWin</code>	Handle to the widget.
<code>int</code>	<code>ItemIndex</code>	Index of the item to display.
<code>int</code>	<code>x0</code>	Leftmost coordinate of the client area/current tab in window coordinates.
<code>int</code>	<code>y0</code>	Topmost coordinate of the client area/current tab in window coordinates.
<code>int</code>	<code>x1</code>	Rightmost coordinate of the client area/current tab in window coordinates.
<code>int</code>	<code>y1</code>	Bottommost coordinate of the client area/current tab in window coordinates.
<code>void *</code>	<code>p</code>	Pointer to a <code>MULTIPAGE_SKIN_INFO</code> structure.

#### Elements of structure `MULTIPAGE_SKIN_INFO`

Data type	Element	Description
<code>GUI_ROTATION *</code>	<code>pRotation</code>	<code>GUI_ROTATE_0</code> , if the <code>MULTIPAGE</code> widget is horizontal. <code>GUI_ROTATE_CW</code> , if the <code>MULTIPAGE</code> widget is vertical.
<code>unsigned</code>	<code>Align</code>	Current alignment of the <code>MULTIPAGE</code> widget. Contains an or-combination of the bit definitions listed below.
<code>int</code>	<code>Sel</code>	Index of the currently selected item. This helps to determine if the currently processed item is selected and therefore might require to be drawn in a different way.
<code>U16</code>	<code>State</code>	Current state of the <code>MULTIPAGE</code> widget. See table below.
<code>U8</code>	<code>FrameFlags</code>	Determines which lines of the frame need to be drawn using an or-combination of the bit definitions listed below.
<code>U8</code>	<code>PageStatus</code>	State of the current page.

Possible bits set in the element <i>Align</i>	
MULTIPAGE_ALIGN_RIGHT	If set, items must be aligned to the right. Otherwise items must be aligned to the left.
MULTIPAGE_ALIGN_BOTTOM	If set, items must be aligned to the bottom. Otherwise items must be aligned to the left.
Possible bits set in the element <i>State</i>	
WIDGET_STATE_VERTICAL	If set, items must be drawn in vertical order. Otherwise items must be drawn in horizontal order.
Possible bits set in the element <i>FrameFlags</i>	
MULTIPAGE_SKIN_FRAME_TOP	If set, the top line of the frame needs to be drawn.
MULTIPAGE_SKIN_FRAME_BOTTOM	If set, the bottom line of the frame needs to be drawn.
MULTIPAGE_SKIN_FRAME_LEFT	If set, the left line of the frame needs to be drawn.
MULTIPAGE_SKIN_FRAME_RIGHT	If set, the right line of the frame needs to be drawn.
Possible bits set in the element <i>PageStatus</i>	
MULTIPAGE_STATE_ENABLED	If set, items must be drawn in vertical order. Otherwise items must be drawn in horizontal order.

#### 7.4.14.4.1 WIDGET\_ITEM\_CREATE

The skinning routine should, if necessary, set up skin related properties like e.g. transparency or text alignment.

#### 7.4.14.4.2 WIDGET\_ITEM\_DRAW\_BACKGROUND

The skinning routine should draw the background of the given tab.

#### 7.4.14.4.3 WIDGET\_ITEM\_DRAW\_FRAME

The skinning routine should draw the surrounding frame. In case *ItemIndex* is given with  $-1$  the frame of the client window has to be drawn. In case of  $ItemIndex \geq 0$ , a single tab should be drawn. The coordinates in the *WIDGET\_ITEM\_DRAW\_INFO* structure are set according to the *ItemIndex*.

#### 7.4.14.4.4 WIDGET\_ITEM\_DRAW\_TEXT

The skinning routine should draw the text.

### 7.4.15 PROGBAR\_SKIN\_FLEX

The following picture shows the details of the skin:

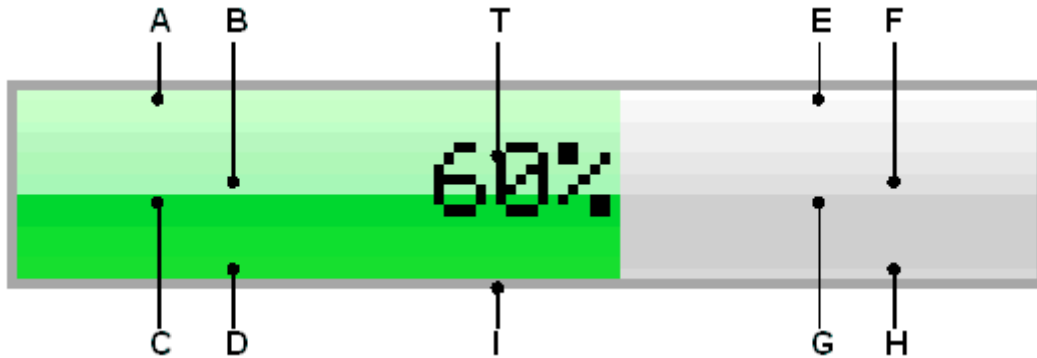

The PROGBAR skin consists of a bar with a thin border. The background is drawn by 4 gradients, a top and a bottom gradient at the left and at the right side and a text which shows the current state per default:

Detail	Description
A	Top color of top left gradient.
B	Bottom color of top left gradient.
C	Top color of bottom left gradient.
D	Bottom color of bottom left gradient.
E	Top color of top right gradient.
F	Bottom color of top right gradient.
G	Top color of bottom right gradient.
H	Bottom color of bottom right gradient.
I	Color of frame.
T	Text (optional).

#### 7.4.15.1 Configuration structure

To set up the default appearance of the skin or to change it at run time configuration structures of type `PROGBAR_SKINFLEX_PROPS` are used:

##### Elements of structure `PROGBAR_SKINFLEX_PROPS`

Data type	Element	Description
U32	<code>aColorUpperL[2]</code>	[0] - Top color of top gradient. [1] - Bottom color of top gradient.
U32	<code>aColorLowerL[2]</code>	[0] - Top color of bottom gradient. [1] - Bottom color of bottom gradient.
U32	<code>aColorUpperR[2]</code>	[0] - Top color of top gradient. [1] - Bottom color of top gradient.
U32	<code>aColorLowerR[2]</code>	[0] - Top color of bottom gradient. [1] - Bottom color of bottom gradient.
U32	<code>ColorFrame</code>	Color of frame.
U32	<code>ColorText</code>	Color of text.

### 7.4.15.2 Configuration options

The default appearance of the skin can be determined by setting custom configuration structures of the above type in `GUIConf.h`. The following table shows the available configuration options:

Macro	Description
<code>PROGBAR_SKINPROPS</code>	Defines the default attributes used for drawing the skin.

### 7.4.15.3 Skinning API

The table below lists the available routines in alphabetical order:

Routine	Description
<code>PROGBAR_DrawSkinFlex()</code>	Skinning callback function of <code>PROGBAR_SKIN_FLEX</code> . (Explained at the beginning of the chapter)
<code>PROGBAR_GetSkinFlexProps()</code>	Returns the properties of the given <code>PROGBAR</code> skin. (Explained at the beginning of the chapter)
<code>PROGBAR_SetDefaultSkin()</code>	Sets the default skin used for new <code>PROGBAR</code> widgets. (Explained at the beginning of the chapter)
<code>PROGBAR_SetDefaultSkinClassic()</code>	Sets the classical design as default for new <code>PROGBAR</code> widgets. (Explained at the beginning of the chapter)
<code>PROGBAR_SetSkin()</code>	Sets a skin for the given <code>PROGBAR</code> widget. (Explained at the beginning of the chapter)
<code>PROGBAR_SetSkinClassic()</code>	Sets the classical design for the given <code>PROGBAR</code> widget. (Explained at the beginning of the chapter)
<code>PROGBAR_SetSkinFlexProps()</code>	The function can be used to change the colors of the skin.

### 7.4.15.3.1 PROGBAR\_SetSkinFlexProps()

Before	After
	

#### Additional information

The function passes a pointer to a `PROGBAR_SKINFLEX_PROPS` structure. It can be used to set up the colors of the skin. The function `PROGBAR_GetSkinFlexProps()` can be used to get the current attributes of the skin.

## 7.4.15.4 List of commands

The skinning routine receives a pointer to a `WIDGET_ITEM_DRAW_INFO` structure. The `Cmd` member of this structure contains the command which needs to be processed. The following table shows all commands passed to the `PROGBAR_SKIN_FLEX` callback function:

Command	Description
<code>WIDGET_ITEM_CREATE</code>	Is sent immediately after creating the widget.
<code>WIDGET_ITEM_DRAW_BACKGROUND</code>	The skinning function should draw the background.
<code>WIDGET_ITEM_DRAW_FRAME</code>	The skinning function should draw the frame.
<code>WIDGET_ITEM_DRAW_TEXT</code>	The skinning function should draw the text.

### 7.4.15.4.1 WIDGET\_ITEM\_CREATE

The skinning routine should, if necessary, set up skin related properties like e.g. transparency or text alignment.

### 7.4.15.4.2 WIDGET\_ITEM\_DRAW\_BACKGROUND

The skinning routine should draw the background.

#### Elements of structure `WIDGET_ITEM_DRAW_INFO`

Data type	Element	Description
<code>WM_HWIN</code>	<code>hWin</code>	Handle to the widget.
<code>int</code>	<code>ItemIndex</code>	Is always 0.
<code>int</code>	<code>x0</code>	Leftmost coordinate of widget area in window coordinates.
<code>int</code>	<code>y0</code>	Topmost coordinate of widget area in window coordinates.
<code>int</code>	<code>x1</code>	Rightmost coordinate of widget area in window coordinates.
<code>int</code>	<code>y1</code>	Bottommost coordinate of widget area in window coordinates.
<code>void *</code>	<code>p</code>	Pointer to a <code>PROGBAR_SKINFLEX_INFO</code> structure.

#### Elements of structure `PROGBAR_SKINFLEX_INFO`

Data type	Element	Description
<code>int</code>	<code>IsVertical</code>	0 if the progress bar is horizontal, 1 if it is vertical.
<code>int</code>	<code>Index</code>	See table below.
<code>const char *</code>	<code>pText</code>	Pointer to the text to be drawn.

Permitted values for element <code>Index</code>	
<code>PROGBAR_SKINFLEX_L</code>	Horizontal progress bar: The left part should be drawn. Vertical progress bar: The top part should be drawn.
<code>PROGBAR_SKINFLEX_R</code>	Horizontal progress bar: The right part should be drawn. Vertical progress bar: The bottom part should be drawn.

#### Additional information

The message is sent twice, once for the left/top part and once for the right/bottom part of the progress bar. The information in the `PROGBAR_SKINFLEX_INFO` structure pointed by element `p` of the `WIDGET_ITEM_DRAW_INFO` structure can be used to get the information what exactly should be drawn. The parameters `x0`, `y0`, `x1` and `y1` of the `WIDGET_ITEM_DRAW_INFO` structure mark only the area which should be drawn, left/right or top/bottom.



### 7.4.15.4.3 WIDGET\_ITEM\_DRAW\_FRAME

The skinning routine should draw the surrounding frame.

#### Elements of structure WIDGET\_ITEM\_DRAW\_INFO

Data	Element	Description
WM_HWIN	hWin	Handle to the widget.
int	ItemIndex	Is always 0.
int	x0	Leftmost coordinate of widget area in window coordinates.
int	y0	Topmost coordinate of widget area in window coordinates.
int	x1	Rightmost coordinate of widget area in window coordinates.
int	y1	Bottommost coordinate of widget area in window coordinates.

### 7.4.15.4.4 WIDGET\_ITEM\_DRAW\_TEXT

The skinning routine should draw the text.

#### Elements of structure WIDGET\_ITEM\_DRAW\_INFO

A detailed description of the elements can be found under *WIDGET\_ITEM\_DRAW\_FRAME* on page 2835.

### 7.4.16 RADIO\_SKIN\_FLEX

The following picture shows the details of the skin:

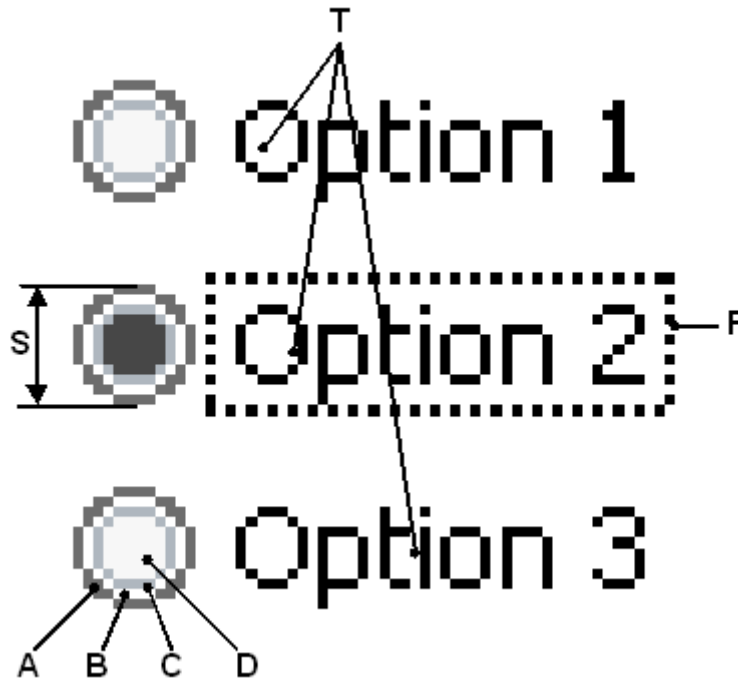

The RADIO skin consists of a configurable button and a text for each item. If the widget has the input focus the currently selected item text is surrounded by a focus rectangle:

Detail	Description
A	Outer color of button frame.
B	Middle color of button frame.
C	Inner color of button frame.
D	Inner color of button.
F	Focus rectangle.
S	Size of button.
T	Item text.

#### 7.4.16.1 Configuration structure

To set up the default appearance of the skin or to change it at run time configuration structures of type RADIO\_SKINFLEX\_PROPS are used:

##### Elements of structure RADIO\_SKINFLEX\_PROPS

Data type	Element	Description
U32	aColorButton[4]	[0] - Outer color of button frame. [1] - Middle color of button frame. [2] - Inner color of button frame. [3] - Inner color of button.
int	ButtonSize	Size of the button in pixels. Only even values are allowed. If an odd value is entered, the value will be reduced by 1.

## 7.4.16.2 Configuration options

The default appearance of the skin can be determined by setting custom configuration structures of the above type in `GUIConf.h`. The following table shows the available configuration options:

Macro	Description
<code>RADIO_SKINPROPS_CHECKED</code>	Defines the default attributes used for checked state.
<code>RADIO_SKINPROPS_UNCHECKED</code>	Defines the default attributes used for unchecked state.

## 7.4.16.3 Skinning API

The table below lists the available routines in alphabetical order:

Routine	Description
<code>RADIO_DrawSkinFlex()</code>	Skinning callback function of <code>RADIO_SKIN_FLEX</code> . (Explained at the beginning of the chapter)
<code>RADIO_GetSkinFlexProps()</code>	Returns the properties of the given RADIO skin. (Explained at the beginning of the chapter)
<code>RADIO_SetDefaultSkin()</code>	Sets the default skin used for new RADIO widgets. (Explained at the beginning of the chapter)
<code>RADIO_SetDefaultSkinClassic()</code>	Sets the classical design as default for new RADIO widgets. (Explained at the beginning of the chapter)
<code>RADIO_SetSkin()</code>	Sets a skin for the given RADIO widget. (Explained at the beginning of the chapter)
<code>RADIO_SetSkinClassic()</code>	Sets the classical design for the given RADIO widget. (Explained at the beginning of the chapter)
<code>RADIO_SetSkinFlexProps()</code>	The function can be used to change the colors of the skin and the size of the button.

### 7.4.16.3.1 RADIO\_SetSkinFlexProps()

Before	After
<input type="radio"/> Option 1 <input checked="" type="radio"/> Option 2 <input type="radio"/> Option 3	<input type="radio"/> Option 1 <input checked="" type="radio"/> Option 2 <input type="radio"/> Option 3

#### Description

The function can be used to change the colors of the skin and the size of the button.

#### Prototype

```
void RADIO_SetSkinFlexProps(const RADIO_SKINFLEX_PROPS * pProps,
                           int Index);
```

#### Parameters

Parameter	Description
<code>pProps</code>	Pointer to a structure of type <code>RADIO_SKINFLEX_PROPS</code> .
<code>Index</code>	0 for checked properties, 1 for unchecked properties.

#### Additional information

The function passes a pointer to a `RADIO_SKINFLEX_PROPS` structure. It can be used to set up the colors and the button size of the skin. The function `RADIO_GetSkinFlexProps()` can be used to get the current attributes of the skin.

## 7.4.16.4 List of commands

The skinning routine receives a pointer to a `WIDGET_ITEM_DRAW_INFO` structure. The `Cmd` member of this structure contains the command which needs to be processed. The following table shows all commands passed to the `RADIO_SKIN_FLEX` callback function:

Command	Description
<code>WIDGET_ITEM_CREATE</code>	Is sent immediately after creating the widget.
<code>WIDGET_ITEM_DRAW_BUTTON</code>	The skinning function should draw the button of one item.
<code>WIDGET_ITEM_DRAW_FOCUS</code>	The skinning function should draw the focus rectangle.
<code>WIDGET_ITEM_DRAW_TEXT</code>	The skinning function should draw the text of one item.
<code>WIDGET_ITEM_GET_BUTTONSIZE</code>	The skinning function should return the button size.

### WIDGET\_ITEM\_CREATE

The skinning routine should, if necessary, set up skin related properties like e.g. transparency or text alignment.

### WIDGET\_ITEM\_DRAW\_BUTTON

The skinning routine should draw the button of one item.

### Elements of structure `WIDGET_ITEM_DRAW_INFO`

Data type	Element	Description
<code>WM_HWIN</code>	<code>hWin</code>	Handle to the widget.
<code>int</code>	<code>ItemIndex</code>	Index of item to be drawn.
<code>int</code>	<code>x0</code>	Leftmost coordinate of the button area in window coordinates.
<code>int</code>	<code>y0</code>	Topmost coordinate of the button area in window coordinates.
<code>int</code>	<code>x1</code>	Rightmost coordinate of the button area in window coordinates.
<code>int</code>	<code>y1</code>	Bottommost coordinate of the button area in window coordinates.

#### 7.4.16.4.1 WIDGET\_ITEM\_DRAW\_FOCUS

The skinning routine should draw the focus rectangle around the text of the currently selected item.

##### Elements of structure WIDGET\_ITEM\_DRAW\_INFO

Data type	Element	Description
WM_HWIN	hWin	Handle to the widget.
int	ItemIndex	Index of item to be drawn.
int	x0	Leftmost coordinate of the focus rectangle in window coordinates.
int	y0	Topmost coordinate of the focus rectangle in window coordinates.
int	x1	Rightmost coordinate of the focus rectangle in window coordinates.
int	y1	Bottommost coordinate of the focus rectangle in window coordinates.

##### Additional information

The given rectangular area in x0, y0, x1 and y1 considers the font settings and the item text.

#### 7.4.16.4.2 WIDGET\_ITEM\_DRAW\_TEXT

The skinning routine should draw the text of one item.

##### Elements of structure WIDGET\_ITEM\_DRAW\_INFO

Data type	Element	Description
WM_HWIN	hWin	Handle to the widget.
int	ItemIndex	Index of item to be drawn.
int	x0	Leftmost coordinate of the text area in window coordinates.
int	y0	Topmost coordinate of the text area in window coordinates.
int	x1	Rightmost coordinate of the text area in window coordinates.
int	y1	Bottommost coordinate of the text area in window coordinates.

##### Additional information

The given rectangular area in x0, y0, x1 and y1 considers the font settings and the item text.

#### 7.4.16.4.3 WIDGET\_ITEM\_GET\_BUTTONSIZE

The skinning routine should return the button size.

### 7.4.17 SCROLLBAR\_SKIN\_FLEX

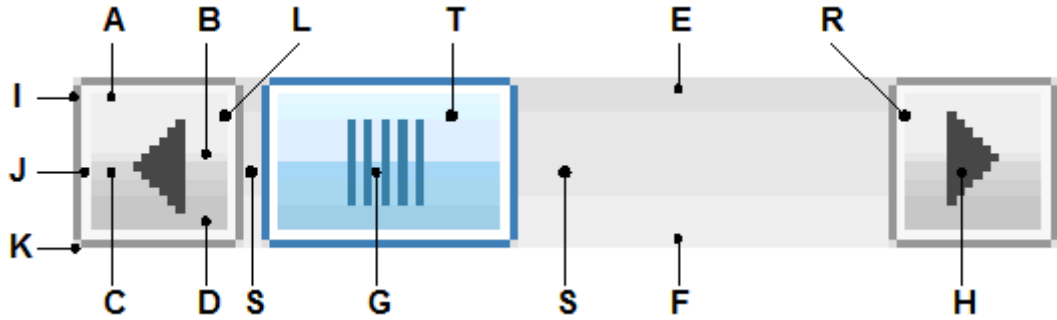

The SCROLLBAR skin consists of a left and a right button with an arrow, a shaft area and a thumb with a grasp:

Detail	Description
A	Top color of top gradient.
B	Bottom color of top gradient.
C	Top color of bottom gradient.
D	Bottom color of bottom gradient.
E	Top color of shaft gradient.
F	Bottom color of shaft gradient.
G	Grasp of thumb area.
H	Button arrow.
I	Outer frame color.
J	Inner frame color.
K	Color of frame edges.
L	Left button.
T	Thumb area.
R	Right button.
S	Shaft area.

#### 7.4.17.1 Configuration structure

To set up the default appearance of the skin or to change it at run time configuration structures of type SCROLLBAR\_SKINFLEX\_PROPS are used:

#### Elements of structure SCROLLBAR\_SKINFLEX\_PROPS

Data type	Element	Description
U32	aColorFrame[3]	[0] - Outer frame color. [1] - Inner frame color. [2] - Color of frame edges
U32	aColorUpper[2]	[0] - Top color of top gradient. [1] - Bottom color of top gradient.
U32	aColorLower[2]	[0] - Top color of bottom gradient. [1] - Bottom color of bottom gradient.
U32	aColorShaft[2]	[0] - Top color of shaft gradient. [1] - Bottom color of shaft gradient.
U32	ColorArrow	Color of button arrow.
U32	ColorGrasp	Color of grasp.

### 7.4.17.2 Configuration options

The default appearance of the skin can be determined by setting custom configuration structures of the above type in `GUIConf.h`. The following table shows the available configuration options:

Macro	Description
<code>SCROLLBAR_SKINPROPS_PRESSED</code>	Defines the default attributes used for pressed state.
<code>SCROLLBAR_SKINPROPS_UNPRESSED</code>	Defines the default attributes used for unpressed state.

### 7.4.17.3 Skinning API

The table below lists the available routines in alphabetical order:

Routine	Description
<code>SCROLLBAR_DrawSkinFlex()</code>	Skinning callback function of <code>SCROLLBAR_SKIN_FLEX</code> . (Explained at the beginning of the chapter)
<code>SCROLLBAR_GetSkinFlexProps()</code>	Returns the properties of the given <code>SCROLLBAR</code> skin. (Explained at the beginning of the chapter)
<code>SCROLLBAR_SetDefaultSkin()</code>	Sets the default skin used for new <code>SCROLLBAR</code> widgets. (Explained at the beginning of the chapter)
<code>SCROLLBAR_SetDefaultSkinClassic()</code>	Sets the classical design as default for new <code>SCROLLBAR</code> widgets. (Explained at the beginning of the chapter)
<code>SCROLLBAR_SetSkin()</code>	Sets a skin for the given <code>SCROLLBAR</code> widget. (Explained at the beginning of the chapter)
<code>SCROLLBAR_SetSkinClassic()</code>	Sets the classical design for the given <code>SCROLLBAR</code> widget. (Explained at the beginning of the chapter)
<code>SCROLLBAR_SetSkinFlexProps()</code>	The function can be used to change the colors of the skin and the size of the button.



### 7.4.17.3.1 SCROLLBAR\_SetSkinFlexProps()



#### Description

The function can be used to change the colors of the skin and the size of the button.

#### Prototype

```
void SCROLLBAR_SetSkinFlexProps(const SCROLLBAR_SKINFLEX_PROPS * pProps,
                                int Index);
```

#### Parameters

Parameter	Description
<code>pProps</code>	Pointer to a structure of type <code>SCROLLBAR_SKINFLEX_PROPS</code> .
<code>Index</code>	Should be 0.

Permitted values for parameter <code>Index</code>	
<code>SCROLLBAR_SKINFLEX_PI_PRESSED</code>	Properties for pressed state.
<code>SCROLLBAR_SKINFLEX_PI_UNPRESSED</code>	Properties for unpressed state.

#### Additional information

The function passes a pointer to a `SCROLLBAR_SKINFLEX_PROPS` structure. It can be used to set up the colors of the skin. The function `SCROLLBAR_GetSkinFlexProps()` can be used to get the current attributes of the skin.

## 7.4.17.4 List of commands

The skinning routine receives a pointer to a `WIDGET_ITEM_DRAW_INFO` structure. The `Cmd` member of this structure contains the command which needs to be processed. The following table shows all commands passed to the `SCROLLBAR_SKIN_FLEX` callback function:

Command	Description
<code>WIDGET_ITEM_CREATE</code>	Is sent immediately after creating the widget.
<code>WIDGET_ITEM_DRAW_BUTTON_L</code>	The skinning function should draw the left button.
<code>WIDGET_ITEM_DRAW_BUTTON_R</code>	The skinning function should draw the right button.
<code>WIDGET_ITEM_DRAW_OVERLAP</code>	The skinning function should draw the overlapping area.
<code>WIDGET_ITEM_DRAW_SHAFT_L</code>	The skinning function should draw the left part of the shaft.
<code>WIDGET_ITEM_DRAW_SHAFT_R</code>	The skinning function should draw the right part of the shaft.
<code>WIDGET_ITEM_DRAW_THUMB</code>	The skinning function should draw the thumb.
<code>WIDGET_ITEM_GET_BUTTONSIZE</code>	The skinning function should return the button size.

### 7.4.17.4.1 WIDGET\_ITEM\_DRAW\_BUTTON\_L

### 7.4.17.4.2 WIDGET\_ITEM\_DRAW\_BUTTON\_R

The skinning routine should draw a button.

#### Elements of structure `WIDGET_ITEM_DRAW_INFO`

Data type	Element	Description
<code>WM_HWIN</code>	<code>hWin</code>	Handle to the widget.
<code>int</code>	<code>ItemIndex</code>	Index of item to be drawn.
<code>int</code>	<code>x0</code>	Leftmost coordinate of the button in window coordinates.
<code>int</code>	<code>y0</code>	Topmost coordinate of the button in window coordinates.
<code>int</code>	<code>x1</code>	Rightmost coordinate of the button in window coordinates.
<code>int</code>	<code>y1</code>	Bottommost coordinate of the button in window coordinates.
<code>void *</code>	<code>p</code>	Pointer to a <code>SCROLLBAR_SKINFLEX_INFO</code> structure.

#### Elements of structure `SCROLLBAR_SKINFLEX_INFO`

Datatype	Element	Description
<code>int</code>	<code>IsVertical</code>	0 if the progress bar is horizontal, 1 if it is vertical.
<code>int</code>	<code>State</code>	See table below.

Permitted values for element <code>State</code>	
<code>PRESSED_STATE_NONE</code>	Nothing is pressed.
<code>PRESSED_STATE_RIGHT</code>	The right button is pressed.
<code>PRESSED_STATE_LEFT</code>	The left button is pressed.
<code>PRESSED_STATE_THUMB</code>	The thumb is pressed.

### 7.4.17.4.3 WIDGET\_ITEM\_DRAW\_OVERLAP

The skinning routine should draw the thumb.

#### Elements of structure WIDGET\_ITEM\_DRAW\_INFO

Data type	Element	Description
WM_HWIN	hWin	Handle to the widget.
int	ItemIndex	Index of item to be drawn.
int	x0	Leftmost coordinate of the overlapping area in window coordinates.
int	y0	Topmost coordinate of the overlapping area in window coordinates.
int	x1	Rightmost coordinate of the overlapping area in window coordinates.
int	y1	Bottommost coordinate of the overlapping area in window coordinates.

#### Additional information

An overlapping area can exist if a dialog has a vertical and a horizontal scroll bar at the borders. Normally the overlapping region looks identical to the shaft area.

#### Example

The following screenshot shows a window with 2 scroll bars which have an overlapping region at the lower right corner of the client window:



### 7.4.17.4.4 WIDGET\_ITEM\_DRAW\_SHAFT\_L

### 7.4.17.4.5 WIDGET\_ITEM\_DRAW\_SHAFT\_R

The skinning routine should draw a shaft area.

#### Elements of structure WIDGET\_ITEM\_DRAW\_INFO

Data type	Element	Description
WM_HWIN	hWin	Handle to the widget.
int	ItemIndex	Index of item to be drawn.
int	x0	Leftmost coordinate of the shaft area in window coordinates.
int	y0	Topmost coordinate of the shaft area in window coordinates.
int	x1	Rightmost coordinate of the shaft area in window coordinates.
int	y1	Bottommost coordinate of the shaft area in window coordinates.

#### 7.4.17.4.6 WIDGET\_ITEM\_DRAW\_THUMB

The skinning routine should draw the thumb.

#### Elements of structure WIDGET\_ITEM\_DRAW\_INFO

Data type	Element	Description
WM_HWIN	hWin	Handle to the widget.
int	ItemIndex	Index of item to be drawn.
int	x0	Leftmost coordinate of the thumb area in window coordinates.
int	y0	Topmost coordinate of the thumb area in window coordinates.
int	x1	Rightmost coordinate of the thumb area in window coordinates.
int	y1	Bottommost coordinate of the thumb area in window coordinates.
void *	p	Pointer to a SCROLLBAR_SKINFLEX_INFO structure.

#### SCROLLBAR\_SKINFLEX\_INFO

A detailed description of the elements can be found under *WIDGET\_ITEM\_DRAW\_BUTTON\_L* on page 2866.

#### 7.4.17.4.7 WIDGET\_ITEM\_GET\_BUTTONSIZE

The skinning routine should return the button size. The button size means the following:

- A horizontal scroll bar should return the height of the scroll bar.
- A vertical scroll bar should return the width of the scroll bar.

#### Example

The following code can be used to return the right values in most cases:

```
int _SkinningCallback(const WIDGET_ITEM_DRAW_INFO * pDrawItemInfo) {
    SCROLLBAR_SKINFLEX_INFO * pSkinInfo;
    pSkinInfo = (SCROLLBAR_SKINFLEX_INFO *)pDrawItemInfo->p;
    switch (pDrawItemInfo->Cmd) {
        case WIDGET_ITEM_GET_BUTTONSIZE:
            return (pSkinInfo->IsVertical) ?
                pDrawItemInfo->x1 - pDrawItemInfo->x0 + 1 :
                pDrawItemInfo->y1 - pDrawItemInfo->y0 + 1;
            ...
    }
}
```

### 7.4.18 SLIDER\_SKIN\_FLEX

The following picture shows the details of the skin:

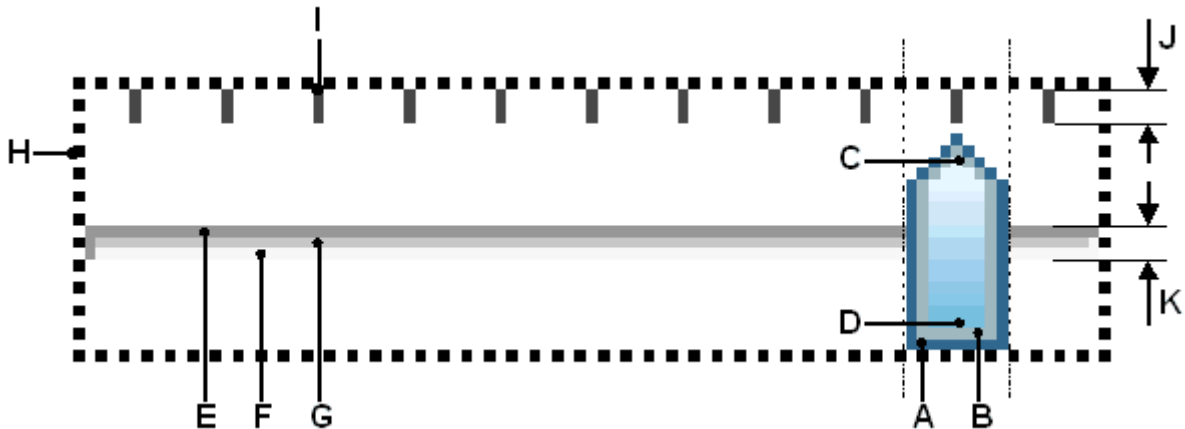

The SLIDER skin consists of a shaft with slider and tick marks above. Further a focus rectangle is shown if the widget has the input focus. The slider is drawn by a frame and a gradient:

Detail	Description
A	Outer color of slider frame.
B	Inner color of slider frame
C	Top color of gradient.
D	Bottom color of gradient.
E	First color of shaft.
F	Second color of shaft.
G	Third color of shaft.
H	Focus rectangle.
I	Tick marks.
J	Size of a tick mark.
K	Size of the shaft.

#### 7.4.18.1 Configuration structure

To set up the default appearance of the skin or to change it at run time configuration structures of type SLIDER\_SKINFLEX\_PROPS are used:

##### Elements of structure SLIDER\_SKINFLEX\_PROPS

Data type	Element	Description
U32	aColorFrame[2]	[0] - Outer frame color. [1] - Inner frame color.
U32	aColorInner[2]	[0] - Top color of gradient. [1] - Bottom color of gradient.
U32	aColorShaft[3]	[0] - First frame color of shaft. [1] - Second frame color of shaft. [2] - Inner color of shaft.
U32	ColorTick	Color of tick marks.
U32	ColorFocus	Color of focus rectangle.
int	TickSize	Size of tick marks.

Data type	Element	Description
int	ShaftSize	Size of shaft.

### 7.4.18.2 Configuration options

The default appearance of the skin can be determined by setting custom configuration structures of the above type in `GUIConf.h`. The following table shows the available configuration options:

Macro	Description
<code>SLIDER_SKINPROPS_PRESSED</code>	Defines the default attributes used for pressed state.
<code>SLIDER_SKINPROPS_UNPRESSED</code>	Defines the default attributes used for unpressed state.

### 7.4.18.3 Skinning API

The table below lists the available routines in alphabetical order:

Routine	Description
<code>SLIDER_DrawSkinFlex()</code>	Skinning callback function of <code>SLIDER_SKIN_FLEX</code> . (Explained at the beginning of the chapter)
<code>SLIDER_GetSkinFlexProps()</code>	Returns the properties of the given <code>SLIDER</code> skin. (Explained at the beginning of the chapter)
<code>SLIDER_SetDefaultSkin()</code>	Sets the default skin used for new <code>SLIDER</code> widgets. (Explained at the beginning of the chapter)
<code>SLIDER_SetDefaultSkinClassic()</code>	Sets the classical design as default for new <code>SLIDER</code> widgets. (Explained at the beginning of the chapter)
<code>SLIDER_SetSkin()</code>	Sets a skin for the given <code>SLIDER</code> widget. (Explained at the beginning of the chapter)
<code>SLIDER_SetSkinClassic()</code>	Sets the classical design for the given <code>SLIDER</code> widget. (Explained at the beginning of the chapter)
<code>SLIDER_SetSkinFlexProps()</code>	The function can be used to change colors, tick mark and shaft size of the skin.

### 7.4.18.3.1 SLIDER\_SetSkinFlexProps()



#### Description

The function can be used to change colors, tick mark and shaft size of the skin.

#### Prototype

```
void SLIDER_SetSkinFlexProps(const SLIDER_SKINFLEX_PROPS * pProps,
                             int Index);
```

#### Parameters

Parameter	Description
<a href="#">pProps</a>	Pointer to a structure of type <code>SLIDER_SKINFLEX_PROPS</code> .
<a href="#">Index</a>	Should be 0.

#### Permitted values for parameter [Index](#)

<code>SLIDER_SKINFLEX_PI_PRESSED</code>	Properties for pressed state.
<code>SLIDER_SKINFLEX_PI_UNPRESSED</code>	Properties for unpressed state.

#### Additional information

The function passes a pointer to a `SLIDER_SKINFLEX_PROPS` structure. It can be used to set up the colors of the skin. The function `SLIDER_GetSkinFlexProps()` can be used to get the current attributes of the skin.

## 7.4.18.4 List of commands

The skinning routine receives a pointer to a `WIDGET_ITEM_DRAW_INFO` structure. The `Cmd` member of this structure contains the command which needs to be processed. The following table shows all commands passed to the `SLIDER_SKIN_FLEX` callback function:

Command	Description
<code>WIDGET_ITEM_CREATE</code>	Is sent immediately after creating the widget.
<code>WIDGET_ITEM_DRAW_FOCUS</code>	The skinning function should draw the focus rectangle.
<code>WIDGET_ITEM_DRAW_SHAFT</code>	The skinning function should draw the shaft.
<code>WIDGET_ITEM_DRAW_THUMB</code>	The skinning function should draw the slider.
<code>WIDGET_ITEM_DRAW_TICKS</code>	The skinning function should draw the tick marks.

### 7.4.18.4.1 WIDGET\_ITEM\_CREATE

The skinning routine should, if necessary, set up skin related properties like e.g. transparency or text alignment.

### 7.4.18.4.2 WIDGET\_ITEM\_DRAW\_FOCUS

The skinning routine should draw the focus rectangle.

#### Elements of structure `WIDGET_ITEM_DRAW_INFO`

Data type	Element	Description
<code>WM_HWIN</code>	<code>hWin</code>	Handle to the widget.
<code>int</code>	<code>ItemIndex</code>	Index of item to be drawn.
<code>int</code>	<code>x0</code>	Leftmost coordinate of the widget in window coordinates.
<code>int</code>	<code>y0</code>	Topmost coordinate of the widget in window coordinates.
<code>int</code>	<code>x1</code>	Rightmost coordinate of the widget in window coordinates.
<code>int</code>	<code>y1</code>	Bottommost coordinate of the widget in window coordinates.

### 7.4.18.4.3 WIDGET\_ITEM\_DRAW\_SHAFT

The skinning routine should draw the shaft.

#### Elements of structure `WIDGET_ITEM_DRAW_INFO`

Data type	Element	Description
<code>WM_HWIN</code>	<code>hWin</code>	Handle to the widget.
<code>int</code>	<code>ItemIndex</code>	Index of item to be drawn.
<code>int</code>	<code>x0</code>	Leftmost coordinate of the widget + 1 in window coordinates.
<code>int</code>	<code>y0</code>	Topmost coordinate of the widget + 1 in window coordinates.
<code>int</code>	<code>x1</code>	Rightmost coordinate of the widget - 1 in window coordinates.
<code>int</code>	<code>y1</code>	Bottommost coordinate of the widget - 1 in window coordinates.



#### 7.4.18.4.4 WIDGET\_ITEM\_DRAW\_THUMB

The skinning routine should draw the slider itself.

##### Elements of structure WIDGET\_ITEM\_DRAW\_INFO

Data type	Element	Description
WM_HWIN	hWin	Handle to the widget.
int	ItemIndex	Index of item to be drawn.
int	x0	Leftmost coordinate of the slider in window coordinates.
int	y0	Topmost coordinate of the slider in window coordinates.
int	x1	Rightmost coordinate of the slider in window coordinates.
int	y1	Bottommost coordinate of the slider in window coordinates.
void *	p	Pointer to a SLIDER_SKINFLEX_INFO structure.

##### Elements of structure SLIDER\_SKINFLEX\_INFO

Data type	Element	Description
int	Width	Width of the slider.
int	IsPressed	1 if the slider is pressed, 0 if not.
int	IsVertical	0 if the slider is horizontal, 1 if it is vertical.

#### 7.4.18.4.5 WIDGET\_ITEM\_DRAW\_TICKS

The skinning routine should draw the tick marks.

##### Elements of structure WIDGET\_ITEM\_DRAW\_INFO

Data type	Element	Description
WM_HWIN	hWin	Handle to the widget.
int	ItemIndex	Index of item to be drawn.
int	x0	Leftmost coordinate of the widget + 1 in window coordinates.
int	y0	Topmost coordinate of the widget + 1 in window coordinates.
int	x1	Rightmost coordinate of the widget - 1 in window coordinates.
int	y1	Bottommost coordinate of the widget - 1 in window coordinates.
void *	p	Pointer to a SLIDER_SKINFLEX_INFO structure.

##### Elements of structure SLIDER\_SKINFLEX\_INFO

Data type	Element	Description
int	Width	Width of the slider.
int	NumTicks	Number of ticks to be drawn.
int	Size	Length of the tick mark line.
int	IsPressed	1 if the slider is pressed, 0 if not.
int	IsVertical	0 if the slider is horizontal, 1 if it is vertical.

### 7.4.19 SPINBOX\_SKIN\_FLEX

The following picture shows the details of the skin:

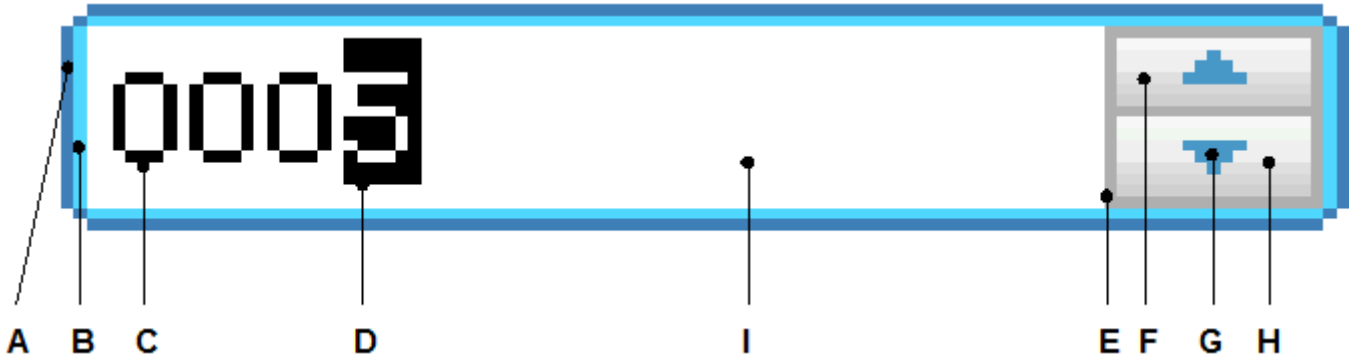

The SPINBOX skin consists of a rounded border and 2 rectangular inner areas which are drawn in dependence of the size of the EDIT widget. The background color of the EDIT widget is set to the set color of the inner area of the SPINBOX widget. The 2 buttons are drawn each with a gradient of 2 colors.

Detail	Description
A	Outer color of surrounding frame.
B	Inner color of surrounding frame.
C	Color of the displayed value.
D	Color of the text cursor (always inverse).
E	Color of the button frame.
F	2 color gradient of the upper button.
G	Arrow color.
H	2 color gradient of the lower button.
I	Background color.

#### Configuration structure

To set up the default appearance of the skin or to change it at run time, configuration structures of type `SPINBOX_SKINFLEX_PROPS` are used:

#### Elements of structure `SPINBOX_SKINFLEX_PROPS`

Data type	Element	Description
GUI_COLOR	aColorFrame[2]	[0] - Outer color of the surrounding frame. [1] - Inner color of the surrounding frame.
GUI_COLOR	aColorUpper[2]	[0] - Upper gradient color of the upper button. [1] - Lower gradient color of the upper button.
GUI_COLOR	aColorLower[2]	[0] - Upper gradient color of the lower button. [1] - Lower gradient color of the lower button.
GUI_COLOR	ColorArrow	Color of the button arrows.
GUI_COLOR	ColorBk	Color of the background.
GUI_COLOR	ColorText	Color of the text.
GUI_COLOR	ColorButtonFrame	Color of the button frame.

### 7.4.19.1 Configuration options

The default appearance of the skin can be determined by setting custom configuration structures of the above type in `GUIConf.h`. The following table shows the available configuration options:

Macro	Description
<code>SPINBOX_SKINPROPS_PRESSED</code>	Defines the default attributes used for pressed state.
<code>SPINBOX_SKINPROPS_FOCUSED</code>	Defines the default attributes used for focused state.
<code>SPINBOX_SKINPROPS_ENABLED</code>	Defines the default attributes used for enabled state.
<code>SPINBOX_SKINPROPS_DISABLED</code>	Defines the default attributes used for disabled state.

### 7.4.19.2 Skinning API

The table below lists the available routines in alphabetical order:

Routine	Description
<code>SPINBOX_DrawSkinFlex()</code>	Skinning callback function of <code>SPINBOX_SKIN_FLEX</code> . (Explained at the beginning of the chapter)
<code>SPINBOX_GetSkinFlexProps()</code>	Returns the properties of the given spinbox skin. (Explained at the beginning of the chapter)
<code>SPINBOX_SetDefaultSkin()</code>	Sets the default skin used for new spinbox widgets. (Explained at the beginning of the chapter)
<code>SPINBOX_SetDefaultSkinClassic()</code>	Sets the classical design as default for new spinbox widgets. (Explained at the beginning of the chapter)
<code>SPINBOX_SetSkin()</code>	Sets a skin for the given spinbox widget. (Explained at the beginning of the chapter)
<code>SPINBOX_SetSkinClassic()</code>	Sets the classical design for the given spinbox widget. (Explained at the beginning of the chapter)
<code>SPINBOX_SetSkinFlexProps()</code>	The function can be used to change the properties of the skin.

### 7.4.19.2.1 SPINBOX\_SetSkinFlexProps()

Before	After
	

#### Description

The function can be used to change the properties of the skin.

#### Prototype

```
void SPINBOX_SetSkinFlexProps(const SPINBOX_SKINFLEX_PROPS * pProps,
                             int Index);
```

#### Parameters

Parameter	Description
<code>pProps</code>	Pointer to a structure of type <code>SPINBOX_SKINFLEX_PROPS</code> .
<code>Index</code>	Should be 0.

Permitted values for parameter <code>Index</code>	
<code>SPINBOX_SKINFLEX_PI_PRESSED</code>	Properties for pressed state.
<code>SPINBOX_SKINFLEX_PI_FOCUSED</code>	Properties for focused state.
<code>SPINBOX_SKINFLEX_PI_ENABLED</code>	Properties for enabled state.
<code>SPINBOX_SKINFLEX_PI_DISABLED</code>	Properties for disabled state.

#### Additional information

The function passes a pointer to a `SPINBOX_SKINFLEX_PROPS` structure. It can be used to set up the colors and the radius of the skin. The function `SPINBOX_GetSkinFlexProps()` can be used to get the current attributes of the skin.

### 7.4.19.3 List of commands

The skinning routine receives a pointer to a `WIDGET_ITEM_DRAW_INFO` structure. The `Cmd` member of this structure contains the command which needs to be processed. The following table shows all commands passed to the `SPINBOX_SKIN_FLEX` callback function:

Command	Description
<code>WIDGET_ITEM_CREATE</code>	Is sent immediately after creating the widget.
<code>WIDGET_ITEM_DRAW_BACKGROUND</code>	The skinning function should draw the background.
<code>WIDGET_ITEM_DRAW_BUTTON_U</code>	The skinning function should draw the upper button.
<code>WIDGET_ITEM_DRAW_BUTTON_D</code>	The skinning function should draw the lower button.
<code>WIDGET_ITEM_DRAW_FRAME</code>	The skinning function should draw the surrounding frame.

The `WIDGET_ITEM_DRAW_INFO` structure is explained at the beginning of the chapter.

#### 7.4.19.3.1 WIDGET\_ITEM\_CREATE

The skinning routine should, if necessary, set up skin related properties like e.g. transparency or text alignment.

#### 7.4.19.3.2 WIDGET\_ITEM\_DRAW\_BACKGROUND

The background should be drawn.

#### Elements of structure `WIDGET_ITEM_DRAW_INFO`

Data type	Element	Description
<code>WM_HWIN</code>	<code>hWin</code>	Handle to the widget.
<code>int</code>	<code>ItemIndex</code>	See table below.
<code>int</code>	<code>x0</code>	Leftmost window coordinate, normally 0.
<code>int</code>	<code>y0</code>	Topmost window coordinate, normally 0.
<code>int</code>	<code>x1</code>	Rightmost window coordinate.
<code>int</code>	<code>y1</code>	Bottommost window coordinate.

#### Permitted values for element `ItemIndex`

<code>SPINBOX_SKINFLEX_PI_PRESSED</code>	The widget is pressed.
<code>SPINBOX_SKINFLEX_PI_FOCUSED</code>	The widget is not pressed but focused.
<code>SPINBOX_SKINFLEX_PI_ENABLED</code>	The widget is not focused but enabled.
<code>SPINBOX_SKINFLEX_PI_DISABLED</code>	The widget is disabled.

#### 7.4.19.3.3 WIDGET\_ITEM\_DRAW\_BUTTON\_U

The upper button should be drawn.

#### `WIDGET_ITEM_DRAW_INFO`

A detailed description of the elements can be found under `WIDGET_ITEM_DRAW_BACKGROUND` on page 2818.

#### **7.4.19.3.4 WIDGET\_ITEM\_DRAW\_BUTTON\_D**

The lower button should be drawn.

#### **WIDGET\_ITEM\_DRAW\_INFO**

A detailed description of the elements can be found under *WIDGET\_ITEM\_DRAW\_BACKGROUND* on page 2818.

#### **WIDGET\_ITEM\_DRAW\_FRAME**

The surrounding frame should be drawn.

#### **WIDGET\_ITEM\_DRAW\_INFO**

A detailed description of the elements can be found under *WIDGET\_ITEM\_DRAW\_BACKGROUND* on page 2818.

## 7.5 Anti-aliasing

Lines are approximated by a series of pixels that must lie at display coordinates. They can therefore appear jagged, particularly lines which are nearly horizontal or nearly vertical. This jaggedness is called aliasing.

Anti-aliasing is the smoothing of lines and curves. It reduces the jagged, stair-step appearance of any line that is not exactly horizontal or vertical. emWin supports different anti-aliasing qualities, anti-aliased fonts and high-resolution coordinates. Support for anti-aliasing is a separate software item and is not included in the emWin basic package. The software for anti-aliasing is located in the subdirectory `GUI\AntiAlias`.

### 7.5.1 Introduction

Anti-aliasing smooths curves and diagonal lines by “blending” the background color with that of the foreground. The higher the number of shades used between background and foreground colors, the better the anti-aliasing result (and the longer the computation time).

### 7.5.2 Quality of anti-aliasing



The quality of anti-aliasing is set by the routine `GUI_AA_SetFactor()`, which is explained later in this chapter. For an idea of the relationship between the anti-aliasing factor and the corresponding result, take a look at the image pictured.



The first line is drawn without anti-aliasing (factor 1). The second line is drawn anti-aliased using factor 2. This means that the number of shades from foreground to background is  $2 * 2 = 4$ . The next line is drawn with an anti-aliasing factor of 3, so there are  $3 * 3 = 9$  shades, and so on. Factor 4 should be sufficient for most applications. Increasing the anti-aliasing factor further does not improve the result significantly, but increases the calculation time dramatically.

### 7.5.3 Anti-aliased fonts

Two types of anti-aliased fonts, low-quality (2bpp) and high-quality (4bpp), are supported. The routines required to display these fonts are automatically linked when using them. The following table shows the effect on drawing the character C without anti-aliasing and with both types of anti-aliased fonts:

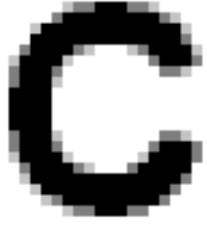
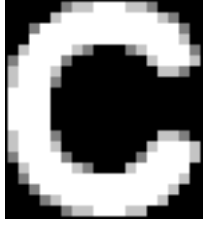
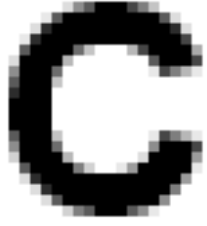
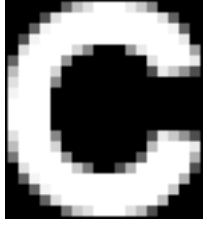
Font type	Black on white	White on black
<b>Standard (no anti-aliasing)</b> 1 bpp 2 shades		
<b>Low-quality (anti-aliased)</b> 2 bpp 4 shades		
<b>High-quality (anti-aliased)</b> 4 bpp 16 shades		

Anti-aliased fonts can be created using the Font Converter. The general purpose of using anti-aliased fonts is to improve the appearance of text. While the effect of using high-quality anti-aliasing will be visually more pleasing than low-quality anti-aliasing, computation time and memory consumption will increase proportionally. Low-quality (2bpp) fonts require twice the memory of non-anti-aliased (1bpp) fonts; high-quality (4bpp) fonts require four times the memory.

#### 7.5.3.1 Character representation in font files

The pixels of anti-aliased fonts are represented by intensity values of 2 bits (2bpp fonts) and 4 bits (4bpp fonts). Those values are used to calculate the pixel intensities (a value between 0 and 255) for mixing the foreground with the background. The intensities are calculated per default as follows:

##### 2bpp

$$\text{Intensity} = \langle \text{value in font} \rangle \times (255 \div 3)$$

##### 4bpp

$$\text{Intensity} = \langle \text{value in font} \rangle \times (255 \div 15)$$

#### 7.5.3.2 Gamma correction

If the above described linear calculation does not lead into the expected appearance, the intensities could be set by the customer. To be able to do that gamma correction should be enabled by `GUI_AA_EnableGammaAA4()` and user defined values should be set by `GUI_AA_SetGammaAA4()`.



### 7.5.4 High-resolution coordinates

When drawing items using anti-aliasing, the same coordinates are used as for regular (non-anti-aliasing) drawing routines. This is the default mode. It is not required to consider the anti-aliasing factor in the function arguments. An anti-aliased line from (50, 100) to (100, 50) would be drawn with the following function call:

```
GUI_AA_DrawLine(50, 100, 100, 50);
```

The high-resolution feature of emWin lets you use the virtual space determined by the anti-aliasing factor and your display size. The advantage of using high-resolution coordinates is that items can be placed not only at physical positions of your display but also "between" them. The virtual space of a high-resolution pixel is illustrated below based on an anti-aliasing factor of 3:

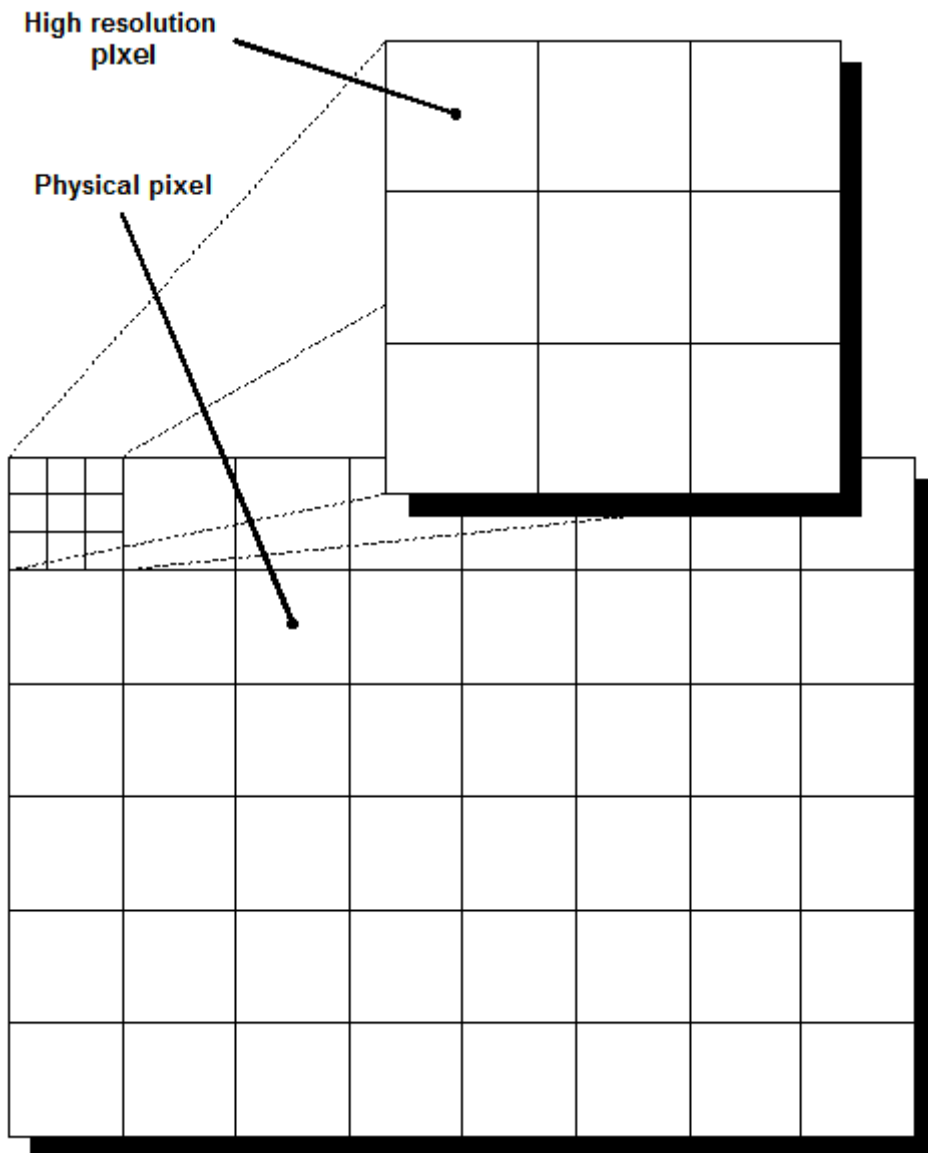

To draw a line from pixel (50, 100) to (100, 50) in high-resolution mode with anti-aliasing factor 3, you would write:

```
GUI_AA_DrawLine(150, 300, 300, 150);
```

High-resolution coordinates must be enabled with the routine `GUI_AA_EnableHiRes()`, and may be disabled with `GUI_AA_DisableHiRes()`. Both functions are explained later in the

chapter. For example programs using the high-resolution feature, see the examples at the end of the chapter.

## 7.5.5 Anti-aliasing API

The table below lists the available routines in the anti-aliasing package, in alphabetical order within their respective categories. Detailed descriptions of the routines can be found in the sections that follow.

Routine	Description
Control functions	
<code>GUI_AA_DisableHiRes()</code>	Disables high-resolution coordinates.
<code>GUI_AA_EnableHiRes()</code>	Enables high-resolution coordinates.
<code>GUI_AA_GetFactor()</code>	Returns the current antialiasing quality factor.
<code>GUI_AA_PreserveTrans()</code>	Makes sure that alpha channel remains after drawing operations.
<code>GUI_AA_SetBufferSize()</code>	Sets the antialiasing buffer size which is required for managing one pixel line.
<code>GUI_AA_SetFactor()</code>	Sets the antialiasing quality factor.
Drawing functions	
<code>GUI_AA_DrawArc()</code>	Displays an antialiased arc at a specified position in the current window.
<code>GUI_AA_DrawCircle()</code>	This function draws an anti aliased circle.
<code>GUI_AA_DrawLine()</code>	Displays an antialiased line at a specified position in the current window.
<code>GUI_AA_DrawPie()</code>	Draws a circle sector.
<code>GUI_AA_DrawPolyOutline()</code>	Displays the outline of an anti-aliased polygon defined by a list of points, at a specified position in the current window and with a specified thickness.
<code>GUI_AA_DrawRoundedFrame()</code>	Draws an anti-aliased rounded frame at a specified position.
<code>GUI_AA_DrawRoundedFrameEx()</code>	Draws an anti-aliased rounded frame using a pointer to a <code>GUI_RECT</code> structure.
<code>GUI_AA_DrawRoundedRect()</code>	Draws the outline of an antialiased rectangle with rounded corners using the current pen size.
<code>GUI_AA_DrawRoundedRectEx()</code>	Draws the outline of an antialiased rectangle with rounded corners using the current pen size.
<code>GUI_AA_FillCircle()</code>	Displays a filled, antialiased circle at a specified position in the current window.
<code>GUI_AA_FillEllipse()</code>	Displays a filled, antialiased ellipse at a specified position in the current window.
<code>GUI_AA_FillEllipseXL()</code>	Displays a filled, antialiased ellipse at a specified position in the current window.
<code>GUI_AA_FillPolygon()</code>	Fills an antialiased polygon defined by a list of points, at a specified position in the current window.
<code>GUI_AA_FillRoundedRect()</code>	Draws a filled and antialiased rectangle with rounded corners.
<code>GUI_AA_FillRoundedRectEx()</code>	Draws a filled and antialiased rectangle with rounded corners.
<code>GUI_AA_SetDrawMode()</code>	This function determines how the background color is fetched for mixing.
Gamma correction	

Routine	Description
<a href="#">GUI_AA_EnableGammaAA4()</a>	Enables custom defined intensity values for 4bpp antialiased fonts.
<a href="#">GUI_AA_GetGammaAA4()</a>	Retrieves the currently used intensity values.
<a href="#">GUI_AA_SetGammaAA4()</a>	Sets the intensity values to be used.

## 7.5.5.1 Control functions

### 7.5.5.1.1 GUI\_AA\_DisableHiRes()

#### Description

Disables high-resolution coordinates.

#### Prototype

```
void GUI_AA_DisableHiRes(void);
```

#### Additional information

High-resolution coordinates are disabled by default.

### 7.5.5.1.2 GUI\_AA\_EnableHiRes()

#### Description

Enables high-resolution coordinates.

#### Prototype

```
void GUI_AA_EnableHiRes(void);
```

### 7.5.5.1.3 GUI\_AA\_GetFactor()

#### Description

Returns the current antialiasing quality factor.

#### Prototype

```
int GUI_AA_GetFactor(void);
```

#### Return value

The current antialiasing factor.

#### 7.5.5.1.4 GUI\_AA\_PreserveTrans()

##### Description

For a detailed description please refer to *GUI\_PreserveTrans* on page 357.

##### Prototype

```
unsigned GUI_AA_PreserveTrans(unsigned OnOff);
```

Parameter	Description
OnOff	1 enables transparency preserving, 0 disables it.

##### Return value

Old state.



### 7.5.5.1.5 GUI\_AA\_SetBufferSize()

#### Description

Sets the antialiasing buffer size which is required for managing one pixel line.

#### Prototype

```
void GUI_AA_SetBufferSize(int BufferSize);
```

#### Parameters

Parameter	Description
BufferSize	Size of the buffer in bytes.

#### Additional information

It is important, that the buffer size is at least as large as the width of the widest display. After the buffer is initialized once, there is no check if the size fits to the requirements of the drawing operation. A too small buffer size leads into undefined behavior. One byte is required for each pixel.

### 7.5.5.1.6 GUI\_AA\_SetFactor()

#### Description

Sets the antialiasing quality factor.

#### Prototype

```
void GUI_AA_SetFactor(int Factor);
```

#### Parameters

Parameter	Description
Factor	Antialiasing quality factor to use. Minimum: 1 (no antialiasing); default: 3; maximum: 6.

#### Additional information

For good quality and performance, it is recommended to use an antialiasing quality factor of 2-4.

## 7.5.5.2 Drawing functions

### 7.5.5.2.1 GUI\_AA\_DrawArc()

#### Description

Displays an antialiased arc at a specified position in the current window.

#### Prototype

```
void GUI_AA_DrawArc(int x0,  
                   int y0,  
                   int rx,  
                   int ry,  
                   int a0,  
                   int a1);
```

#### Parameters

Parameter	Description
<code>x0</code>	Horizontal position of the center.
<code>y0</code>	Vertical position of the center.
<code>rx</code>	Horizontal radius.
<code>ry</code>	Vertical radius.
<code>a0</code>	Starting angle (degrees).
<code>a1</code>	Ending angle (degrees).

#### Limitations

Currently the `ry` parameter is not available. The `rx` parameter is used instead.

#### Additional information

If working in high-resolution mode, position and radius must be in high-resolution coordinates. Otherwise they must be specified in pixels.

### 7.5.5.2.2 GUI\_AA\_DrawCircle()

#### Description

This function draws an anti aliased circle.

#### Prototype

```
void GUI_AA_DrawCircle(int x0,  
                      int y0,  
                      int r);
```

#### Parameters

Parameter	Description
x0	X-center position.
y0	Y-center position.
r	Radius to be used.

#### Additional information

This function uses the set pensize to draw the circle.

### 7.5.5.2.3 GUI\_AA\_DrawLine()

#### Description

Displays an antialiased line at a specified position in the current window.

#### Prototype

```
void GUI_AA_DrawLine(int x0,  
                    int y0,  
                    int x1,  
                    int y1);
```

#### Parameters

Parameter	Description
x0	X-starting position.
y0	Y-starting position.
x1	X-end position.
y1	Y-end position.

#### Additional information

If working in high-resolution mode, the coordinates must be in high-resolution coordinates. Otherwise they must be specified in pixels.

### 7.5.5.2.4 GUI\_AA\_DrawPie()

#### Description

Draws a circle sector.

#### Prototype

```
void GUI_AA_DrawPie(int x0,  
                   int y0,  
                   int r,  
                   I32 a0,  
                   I32 a1);
```

#### Parameters

Parameter	Description
<code>x0</code>	X-position of the center of the circle in pixels of the client window.
<code>y0</code>	Y-position of the center of the circle in pixels of the client window.
<code>r</code>	Radius of the circle (half the diameter).
<code>a0</code>	Starting angle (degrees * 1000).
<code>a1</code>	End angle (degrees * 1000).

### 7.5.5.2.5 GUI\_AA\_DrawPolyOutline()

#### Description

Displays the outline of an anti-aliased polygon defined by a list of points, at a specified position in the current window and with a specified thickness.

If a function pointer has been set with `GUI_AA_SetFuncDrawPolyOutline()`, the set function will be called instead.

#### Prototype

```
void GUI_AA_DrawPolyOutline(const GUI_POINT * pPoints,
                           int NumPoints,
                           int Thickness,
                           int x,
                           int y);
```

#### Parameters

Parameter	Description
<code>pPoints</code>	Pointer to the polygon to display.
<code>NumPoints</code>	Number of points specified in the list of points.
<code>Thickness</code>	<code>Thickness</code> of the outline. If 0 is passed, the current pen size will be used.
<code>x</code>	X-position of origin.
<code>y</code>	Y-position of origin.

#### Additional information

The polyline drawn is automatically closed by connecting the endpoint to the starting point. The starting point must not be specified a second time as an endpoint.

If working in high-resolution mode, the coordinates must be in high-resolution coordinates. Otherwise they must be specified in pixels.

This routine allocates and frees memory for internal calculations. The memory requirement is `sizeof(GUI_POINT) * (NumPoints + 1) * 2` bytes.

#### Example

```
static GUI_POINT _aPoints[] = {
    { 0, 0 },
    { 15, 30 },
    { 0, 20 },
    { -15, 30 }
};
void Sample(void) {
    GUI_AA_DrawPolyOutline(_aPoints, GUI_COUNTOF(_aPoints), 3, 150, 40);
}
```

#### Screenshot of above example



### 7.5.5.2.6 GUI\_AA\_DrawRoundedFrame()

#### Description

Draws an anti-aliased rounded frame at a specified position.

#### Prototype

```
void GUI_AA_DrawRoundedFrame( int x0,
                              int y0,
                              int x1,
                              int y1,
                              int r );
```

#### Parameters

Parameter	Description
x0	X-position of the upper left corner.
y0	Y-position of the upper left corner.
x1	X-position of the lower right corner.
y1	Y-position of the lower right corner.
r	Radius of frame.

#### Additional information

In contrast to a rounded rectangle, an anti-aliased frame does not have semi-transparent lines on the outside. Furthermore, with increased pen size, the drawn frame stays within the given rectangular area.



### 7.5.5.2.7 GUI\_AA\_DrawRoundedFrameEx()

#### Description

Draws an anti-aliased rounded frame using a pointer to a GUI\_RECT structure.

#### Prototype

```
void GUI_AA_DrawRoundedFrameEx(const GUI_RECT * pRect,  
                               int           r);
```

#### Parameters

Parameter	Description
<code>pRect</code>	Pointer to GUI_RECT structure.
<code>r</code>	Radius of frame.

#### Additional information

See `GUI_AA_DrawRoundedFrame()`.

### 7.5.5.2.8 GUI\_AA\_DrawRoundedRect()

#### Description

Draws the outline of an antialiased rectangle with rounded corners using the current pen size.

#### Prototype

```
void GUI_AA_DrawRoundedRect( int x0,
                             int y0,
                             int x1,
                             int y1,
                             int r);
```

#### Parameters

Parameter	Description
x0	X-position of the upper left corner.
y0	Y-position of the upper left corner.
x1	X-position of the lower right corner.
y1	Y-position of the lower right corner.
r	Radius to be used for the rounded corners.

#### Example

```
#include "GUI.h"
void MainTask(void) {
    GUI_Init();
    GUI_SetBkColor(GUI_WHITE);
    GUI_Clear();
    GUI_SetColor(GUI_DARKBLUE);
    GUI_SetPenSize(5);
    GUI_AA_DrawRoundedRect(10, 10, 50, 50, 5);
}
```

#### Screenshot of above example



### 7.5.5.2.9 GUI\_AA\_DrawRoundedRectEx()

#### Description

Draws the outline of an antialiased rectangle with rounded corners using the current pen size.

#### Prototype

```
void GUI_AA_DrawRoundedRectEx(const GUI_RECT * pRect,  
                             int r);
```

#### Parameters

Parameter	Description
<code>pRect</code>	Pointer to the rectangle to draw.
<code>r</code>	Radius to be used for the rounded corners.

### 7.5.5.2.10 GUI\_AA\_FillCircle()

#### Description

Displays a filled, antialiased circle at a specified position in the current window.

#### Prototype

```
void GUI_AA_FillCircle(int x0,  
                      int y0,  
                      int r);
```

#### Parameters

Parameter	Description
<code>x0</code>	X-position of the center of the circle in pixels of the client window.
<code>y0</code>	Y-position of the center of the circle in pixels of the client window.
<code>r</code>	Radius of the circle (half of the diameter).

#### Additional information

If working in high-resolution mode, the coordinates must be in high-resolution coordinates. Otherwise they must be specified in pixels.

### 7.5.5.2.11 GUI\_AA\_FillEllipse()

#### Description

Displays a filled, antialiased ellipse at a specified position in the current window.

#### Prototype

```
void GUI_AA_FillEllipse(int x0,  
                       int y0,  
                       int rx,  
                       int ry);
```

#### Parameters

Parameter	Description
<code>x0</code>	X-position of the center of the ellipse in pixels of the client window.
<code>y0</code>	Y-position of the center of the ellipse in pixels of the client window.
<code>rx</code>	Radius in X of the ellipse.
<code>ry</code>	Radius in Y of the ellipse.

#### Additional information

If working in high-resolution mode, the coordinates must be in high-resolution coordinates. Otherwise they must be specified in pixels.

### 7.5.5.2.12 GUI\_AA\_FillEllipseXL()

#### Description

Displays a filled, antialiased ellipse at a specified position in the current window.

#### Prototype

```
void GUI_AA_FillEllipseXL(int x0,  
                          int y0,  
                          int rx,  
                          int ry);
```

#### Parameters

Parameter	Description
<code>x0</code>	X-position of the center of the ellipse in pixels of the client window.
<code>y0</code>	Y-position of the center of the ellipse in pixels of the client window.
<code>rx</code>	Radius in X of the ellipse.
<code>ry</code>	Radius in Y of the ellipse.

#### Additional information

If working in high-resolution mode, the coordinates must be in high-resolution coordinates. Otherwise they must be specified in pixels.

This function can be used for large ellipses.

### 7.5.5.2.13 GUI\_AA\_FillPolygon()

#### Description

Fills an antialiased polygon defined by a list of points, at a specified position in the current window.

#### Prototype

```
void GUI_AA_FillPolygon(const GUI_POINT * pPoints,  
                        int NumPoints,  
                        int x0,  
                        int y0);
```

#### Parameters

Parameter	Description
<code>pPoint</code>	Pointer to the polygon to display.
<code>NumPoints</code>	Number of points specified in the list of points.
<code>x</code>	X-position of origin.
<code>y</code>	Y-position of origin.

#### Additional information

The polyline drawn is automatically closed by connecting the endpoint to the starting point. The starting point must not be specified a second time as an endpoint. If working in high-resolution mode, the coordinates must be in high-resolution coordinates. Otherwise they must be specified in pixels.

### 7.5.5.2.14 GUI\_AA\_FillRoundedRect()

#### Description

Draws a filled and antialiased rectangle with rounded corners.

#### Prototype

```
int GUI_AA_FillRoundedRect(int x0,  
                           int y0,  
                           int x1,  
                           int y1,  
                           int r);
```

#### Parameters

Parameter	Description
x0	X-position of the upper left corner.
y0	Y-position of the upper left corner.
x1	X-position of the lower right corner.
y1	Y-position of the lower right corner.
r	Radius to be used for the rounded corners.

#### Return value

- 0 On success.
- 1 On error due to invalid parameters (e.g. radius is too big).

#### Example

```
#include "GUI.h"  
void MainTask(void) {  
    GUI_Init();  
    GUI_SetBkColor(GUI_WHITE);  
    GUI_Clear();  
    GUI_SetColor(GUI_DARKBLUE);  
    GUI_AA_FillRoundedRect(10, 10, 54, 54, 5);  
}
```

#### Screenshot of above example





### 7.5.5.2.15 GUI\_AA\_FillRoundedRectEx()

#### Description

Draws a filled and antialiased rectangle with rounded corners.

#### Prototype

```
int GUI_AA_FillRoundedRectEx(const GUI_RECT * pRect,  
                             int r);
```

#### Parameters

Parameter	Description
<code>pRect</code>	Pointer to the rectangle to draw.
<code>r</code>	Radius to be used for the rounded corners.

#### Return value

- 0 On success.
- 1 On error due to invalid parameters (e.g. radius is too big).

### 7.5.5.2.16 GUI\_AA\_SetDrawMode()

#### Description

This function determines how the background color is fetched for mixing.

#### Prototype

```
int GUI_AA_SetDrawMode(int Mode);
```

#### Parameters

Parameter	Description
<code>Mode</code>	<code>Mode</code> to be used (see table below)

Permitted values for parameter <code>Mode</code>	
<code>GUI_AA_TRANS</code>	Default behavior. Anti-aliased pixels are mixed with the current content of the frame buffer.
<code>GUI_AA_NOTRANS</code>	Anti-aliased pixels are mixed with the current background color set with <code>GUI_SetBkColor()</code> .

#### Return value

- 0        on success
- 1        if `Mode` did not contain a permitted value.

#### Additional information

The default behavior of antialiasing in emWin is mixing pixels with the current content of the frame buffer. But under certain circumstances using the currently set background color (`GUI_SetBkColor()`) for mixing may be an advantage. This makes it possible to redraw antialiased items completely without having to redraw the background.

### 7.5.5.3 Gamma correction

#### 7.5.5.3.1 GUI\_AA\_EnableGammaAA4()

##### Description

Enables custom defined intensity values for 4bpp antialiased fonts. As described at the beginning of that chapter per default the intensities are calculated by a linear manner. After enabling gamma correction the intensities could be set by `GUI_AA_SetGammaAA4()`.

##### Prototype

```
void GUI_AA_EnableGammaAA4(int OnOff);
```

##### Parameters

Parameter	Description
<code>OnOff</code>	1 for enabling gamma correction, 0 for using linear default values.

### 7.5.5.3.2 GUI\_AA\_GetGammaAA4()

#### Description

Retrieves the currently used intensity values.

#### Prototype

```
void GUI_AA_GetGammaAA4(U8 * pGamma);
```

#### Parameters

Parameter	Description
<a href="#">pGamma</a>	The pointer should point to an array of U8 values.

#### Additional information

The function copies the currently used set of values into the given buffer.

### 7.5.5.3.3 GUI\_AA\_SetGammaAA4()

#### Description

Sets the intensity values to be used.

#### Prototype

```
void GUI_AA_SetGammaAA4(U8 * pGamma);
```

#### Parameters

Parameter	Description
<a href="#">pGamma</a>	The pointer should point to an array of 16 intensity values.

#### Additional information

The function copies the values to an emWin internal buffer.

## 7.5.6 Examples

### 7.5.6.1 Different anti-aliasing factors

The following example creates diagonal lines with and without anti-aliasing. The source code is available as `AA_Lines.c` in the examples shipped with emWin.

```

/*****
 *                               SEGGER Microcontroller GmbH                               *
 *                               Solutions for real time microcontroller applications       *
 *                                                                                       *
 *                               emWin example code                                       *
 *                                                                                       *
 *****/
-----
File      : AA_Lines.c
Purpose   : Shows lines with different antialiasing qualities
-----
*/
#include "GUI.h"
/*****
 *                               Show lines with different antialiasing qualities       *
 *                                                                                       *
 *****/
*/
static void DemoAntialiasing(void) {
    int i, x1, x2, y;
    y = 2;
    //
    // Set drawing attributes
    //
    GUI_SetColor(GUI_BLACK);
    GUI_SetBkColor(GUI_WHITE);
    GUI_Clear();
    x1 = 10;
    x2 = 90;
    //
    // Draw lines without antialiasing
    //
    GUI_DispStringHCenterAt("\nNormal", (x1 + x2) / 2, 10);
    for (i = 1; i < 12; i++) {
        GUI_SetPenSize(i);
        GUI_DrawLine(x1, 40 + i * 15, x2, 40 + i * 15 + y);
    }
    x1 = 110;
    x2 = 190;
    //
    // Draw lines with antialiasing quality factor 2
    //
    GUI_AA_SetFactor(2);
    GUI_DispStringHCenterAt("Antialiased\n\nusing factor 2", (x1 + x2) / 2, 10);
    for (i = 1; i < 12; i++) {
        GUI_SetPenSize(i);
        GUI_AA_DrawLine(x1, 40 + i * 15, x2, 40 + i * 15 + y);
    }
    x1 = 210;
    x2 = 290;
    //
    // Draw lines with antialiasing quality factor 6
    //
    GUI_AA_SetFactor(6);
    GUI_DispStringHCenterAt("Antialiased\n\nusing factor 6", (x1 + x2) / 2, 10);
    for (i = 1; i < 12; i++) {
        GUI_SetPenSize(i);
        GUI_AA_DrawLine(x1, 40 + i * 15, x2, 40 + i * 15 + y);
    }
}

```

```
}  
}  
/*****  
*  
*      MainTask  
*  
*****/  
*/  
void MainTask(void) {  
    GUI_Init();  
    DemoAntialiasing();  
    while(1)  
        GUI_Delay(100);  
}
```

### Screenshot of above example

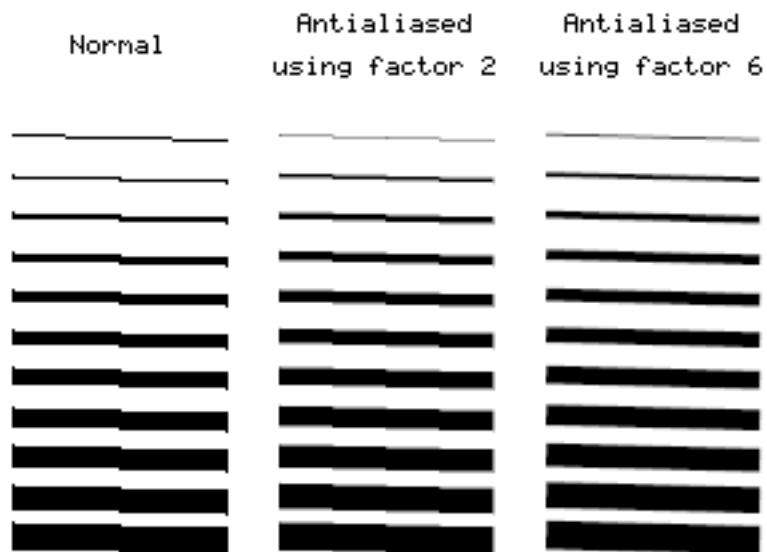

## 7.5.6.2 Lines placed on high-resolution coordinates

This example shows anti-aliased lines placed on high-resolution coordinates. It is available as `AA_HiResPixels.c`.

```

/*****
 *
 *          SEGGER Microcontroller GmbH
 *
 *      Solutions for real time microcontroller applications
 *
 *
 *          emWin example code
 *
 *****/
-----
File       : AA_HiResPixels.c
Purpose    : Demonstrates high resolution pixels
-----
*/
#include "GUI.h"
/*****
 *
 *      Show lines placed on high resolution pixels
 *
 *****/
*/
static void ShowHiResPixels(void) {
    int i, Factor;
    Factor = 5;
    GUI_SetBkColor(GUI_WHITE);
    GUI_SetColor(GUI_BLACK);
    GUI_Clear();
    GUI_SetLBorder(50);
    GUI_DispStringAt("This example uses high resolution pixels.\n", 50, 10);
    GUI_DispString ("Not only the physical pixels are used.\n");
    GUI_DispString ("Enabling high resolution simulates more\n");
    GUI_DispString ("pixels by using antialiasing.\n");
    GUI_DispString ("Please take a look at the magnified output\n");
    GUI_DispString ("to view the result.\n");
    GUI_SetPenSize(2);
    GUI_AA_EnableHiRes();      /* Enable high resolution */
    GUI_AA_SetFactor(Factor); /* Set quality factor */
    //
    // Drawing lines using high resolution pixels
    //
    for (i = 0; i < Factor; i++) {
        int x = (i + 1) * 5 * Factor + i - 1;
        GUI_AA_DrawLine(x, 50, x, 199);
    }
}
/*****
 *
 *      MainTask
 *
 *****/
*/
void MainTask(void) {
    GUI_Init();
    ShowHiResPixels();
    while(1) {
        GUI_Delay(100);
    }
}

```

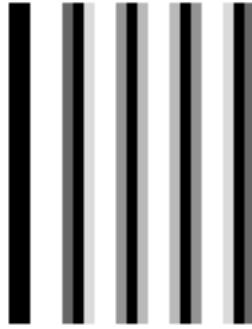

**Magnified screenshot of above example**

### 7.5.6.3 Moving pointer using high-resolution anti-aliasing

This example illustrates the use of high-resolution anti-aliasing by drawing a rotating pointer that turns 0.1 degrees with each step. There is no screenshot of this example because the effects of high-resolution anti-aliasing are only visible in the movement of the pointers. Without high-resolution the pointer appears to make short "jumps", whereas in high-resolution mode there is no apparent jumping. The example can be found as `AA_HiResAntialiasing.c`.

```

/*****
 *
 *      SEGGER Microcontroller GmbH
 *      Solutions for real time microcontroller applications
 *
 *
 *      emWin example code
 *
 *****/
-----
File       : AA_HiResAntialiasing.c
Purpose    : Demonstrates high resolution antialiasing
-----
*/
#include "GUI.H"
/*****
 *
 *      Data
 *
 *****/
*/
#define countof(Obj) (sizeof(Obj)/sizeof(Obj[0]))
static const GUI_POINT aPointer[] = {
    { 0, 3 },
    { 85, 1 },
    { 90, 0 },
    { 85, -1 },
    { 0, -3 }
};
static GUI_POINT aPointerHiRes[countof(aPointer)];
typedef struct {
    GUI_AUTODEV_INFO AutoInfo;
    GUI_POINT aPoints[countof(aPointer)];
    int Factor;
} PARAM;
/*****
 *
 *      Drawing routines
 *
 *****/
*/
static void DrawHiRes(void * p) {
    PARAM * pParam = (PARAM *)p;
    if (pParam->AutoInfo.DrawFixed) {
        GUI_ClearRect(0, 0, 99, 99);
    }
    GUI_AA_FillPolygon(pParam->aPoints, countof(aPointer),
        5 * pParam->Factor, 95 * pParam->Factor);
}
static void Draw(void * p) {
    PARAM * pParam = (PARAM *)p;
    if (pParam->AutoInfo.DrawFixed) {
        GUI_ClearRect(100, 0, 199, 99);
    }
    GUI_AA_FillPolygon(pParam->aPoints, countof(aPointer), 105, 95);
}
/*****
 *
 *      Demonstrate high resolution by drawing rotating pointers
 *
 *****/

```

```

*****
*/
static void ShowHiresAntialiasing(void) {
    GUI_AUTODEV aAuto[2];
    PARAM      Param;
    int        i;
    Param.Factor = 3;
    GUI_DispStringHCenterAt("Using\nhigh\nresolution\nmode", 50, 120);
    GUI_DispStringHCenterAt("Not using\nhigh\nresolution\nmode", 150, 120);
    //
    // Create GUI_AUTODEV objects
    //
    for (i = 0; i < countof(aAuto); i++) {
        GUI_MEMDEV_CreateAuto(&aAuto[i]);
    }
    //
    // Calculate pointer for high resolution
    //
    for (i = 0; i < countof(aPointer); i++) {
        aPointerHiRes[i].x = aPointer[i].x * Param.Factor;
        aPointerHiRes[i].y = aPointer[i].y * Param.Factor;
    }
    GUI_AA_SetFactor(Param.Factor); /* Set antialiasing factor */
    while(1) {
        for (i = 0; i < 1800; i++) {
            float Angle = (i >= 900) ? 1800 - i : i;
            Angle *= 3.1415926f / 1800;
            //
            // Draw pointer with high resolution
            //
            GUI_AA_EnableHiRes();
            GUI_RotatePolygon(Param.aPoints, aPointerHiRes, countof(aPointer), Angle);
            GUI_MEMDEV_DrawAuto(&aAuto[0], &Param.AutoInfo, DrawHiRes, &Param);
            //
            // Draw pointer without high resolution
            //
            GUI_AA_DisableHiRes();
            GUI_RotatePolygon(Param.aPoints, aPointer, countof(aPointer), Angle);
            GUI_MEMDEV_DrawAuto(&aAuto[1], &Param.AutoInfo, Draw, &Param);
            GUI_Delay(2);
        }
    }
}
/*****
*
*      MainTask
*
*****
*/
void MainTask(void) {
    GUI_Init();
    ShowHiresAntialiasing();
}

```

## 7.6 Memory Devices

Memory Devices can be used in a variety of situations, mainly to be used as a buffer for further drawing operations. For example, some images take some time to be displayed or loaded from memory. To reduce the overhead of loading or decoding images again and again, these images be drawn only once into a Memory Device. Later on only the Memory Device has to be displayed which is in most cases a simple `memcpy` operation. This will highly reduce the drawing time for frequently used images.







Memory Devices can also be used to modify a drawing before displaying it. This includes rotation, changing color and alpha values as well as blurring and blending. Further Memory Devices can be used as a last option to prevent flickering, but the first choice should be multi-buffering or a cache in case of an indirect display driver.

### Note

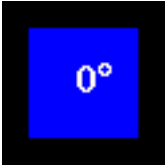
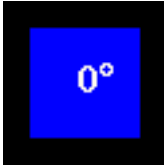
Memory Devices are an additional (optional) software item and are not shipped with the emWin basic package. The software for Memory Devices is located in the subdirectory `GUI\Memdev`.

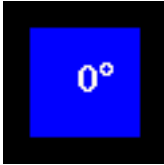
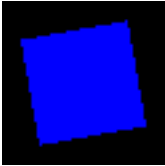
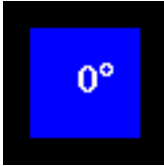
### 7.6.1 Using Memory Devices: Illustration

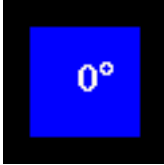
The following table shows screenshots of the same operations handled with and without a Memory Device. The objective in both cases is identical: a work piece is to be rotated and labeled with the respective angle of rotation (here, 10 degrees). In the first case (without a Memory Device) the screen must be cleared, then the polygon is redrawn in the new position and a string with the new label is written. In the second case (with a Memory Device) the same operations are performed in memory, but the screen is not updated during this time. The only update occurs when the routine `GUI_MEMDEV_CopyToLCD` is called, and this update reflects all the operations at once. Note that the initial states and final outputs of both procedures are identical.

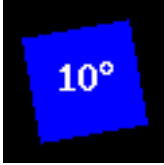
API function	Without Memory Device	With Memory Device
Step 0: Initial state		
Step 1: <code>GUI_Clear()</code>		
Step 2: <code>GUI_DrawPolygon()</code>		
Step 3: <code>GUI_DispString()</code>		
Step 4: <code>GUI_MEMDEV_CopyToLCD()</code> (only when using Memory Device)		

## 7.6.2 Supported color depth (bpp)

Memory Devices are available in 4 different color depths:

- 1 bpp
- 8 bpp
- 16 bpp
- 32 bpp

### Creating Memory Devices "compatible" to the display

There are two ways to create Memory Devices. If they are used to avoid flickering, a Memory Device compatible to the display is created. This "compatible" Memory Device needs to have the same or a higher color depth as the display. emWin automatically selects the "right" type of Memory Device for the display if the functions `GUI_MEMDEV_Create()`, `GUI_MEMDEV_CreateEx()` are used.

The Window Manager, which also has the ability to use Memory Devices for some or all windows in the system, also uses these functions.

This way, the Memory Device with the lowest color depth (using the least memory) is automatically used.

### Creating Memory Devices for other purposes

Memory Devices of any type can be created using `GUI_MEMDEV_CreateFixed()`. A typical application would be the use of a Memory Device for printing as described later in this chapter.

## 7.6.3 Memory Devices and the Window Manager

The Window Manager works seamlessly with Memory Devices. Every window has a flag which tells the Window Manager if a Memory Device should be used for rendering. This flag can be specified when creating the window or set/reset at any time.

If the Memory Device flag is set for a particular window, the WM automatically uses a Memory Device when drawing the window. It creates a Memory Device before drawing a window and deletes it after the drawing operation. If enough memory is available, the whole window fits into the size of the Memory Device created by the WM. If not enough memory is available for the complete window in one Memory Device, the WM uses 'banding' for drawing the window. Details about 'banding' are described in the chapter *Banding Memory Device* on page 2970. The memory used for the drawing operation is only allocated during the drawing operation. If there is not enough memory available when (re-)drawing the window, the window is redrawn without Memory Device.

## 7.6.4 Memory Devices and multiple layers

The Memory Device API does not offer any option to specify a layer. Memory Devices are associated with the current layer at creation. The color conversion settings of the current layer are automatically used by Memory Devices.

### Example

```
//  
// Create a Memory Device associated with layer 1  
//  
GUI_SelectLayer(1);  
hMem = GUI_MEMDEV_Create(0, 0, 100, 100);  
GUI_MEMDEV_Select(hMem);  
GUI_DrawLine(0, 0, 99, 99);  
GUI_MEMDEV_Select(0);  
//  
// Select layer 0  
//  
GUI_SelectLayer(0);  
//  
// The following line copies the Memory Device to layer 1 and not to layer 0  
//  
GUI_MEMDEV_CopyToLCD(hMem);
```

## 7.6.5 Memory requirements

If creating a Memory Device the required number of bytes depends on the color depth of the Memory Device and whether transparency support is needed or not.

### Memory usage without transparency support

The following table shows the memory requirement in dependence of the system color depth for Memory Devices without transparency support.

Color depth of Memory Device	System color depth (LCD_BITSPERPIXEL)	Memory usage
1 bpp	1 bpp	1 byte / 8 pixels: $(XSIZE + 7) \div 8 \times YSIZE$
8 bpp	2, 4 and 8 bpp	$XSIZE \times YSIZE$
16 bpp	12 and 16 bpp	2 bytes / pixel: $XSIZE \times YSIZE \times 2$
32 bpp	18, 24 and 32 bpp	4 bytes / pixel: $XSIZE \times YSIZE \times 4$

### Example

A Memory Device of 111 pixels in X and 33 pixels in Y should be created. It should be compatible to a display with a color depth of 12 bpp and should support transparency. The required number of bytes can be calculated as follows:

$$\text{Number of required bytes} = (111 \times 2 + (111 + 7) \div 8) \times 33 = 7788 \text{ bytes}$$

### Memory usage with transparency support

If a Memory Device should support transparency it needs one additional byte / 8 pixels for internal management.

Color depth of Memory Device	System color depth (LCD_BITSPERPIXEL)	Memory usage
1 bpp	1 bpp	2 byte / 8 pixels: $(XSIZE + 7) \div 8 \times YSIZE \times 2$
8 bpp	2, 4 and 8 bpp	1 bytes / pixel + 1 byte / 8 pixels: $(XSIZE + (XSIZE + 7) \div 8) \times YSIZE$
16 bpp	12 and 16 bpp	2 bytes / pixel + 1 byte / 8 pixels: $(XSIZE \times 2 + (XSIZE + 7) \div 8) \times YSIZE$
32 bpp	18, 24 and 32 bpp	4 bytes / pixel: $XSIZE \times 4 \times YSIZE$

### Example

A Memory Device of 200 pixels in X and 50 pixels in Y should be created. It should be compatible to a display with a color depth of 4bpp and should support transparency. The required number of bytes can be calculated as follows:

$$\text{Number of required bytes} = (200 + (200 + 7) \div 8) \times 50 = 11250 \text{ bytes}$$

### Memory usage with window animation functions

One static Memory Device is created for each, the given window and all of its child window. The color depth is always 32bpp.



## 7.6.6 Performance

Using Memory Devices typically does not significantly affect performance, except static memory devices, which are explained in detail later. When Memory Devices are used, the work of the driver is easier: It simply transfers bitmaps to the display controller. On systems with slow drivers (for example displays connected via serial interface), the performance is better if Memory Devices are used; on systems with a fast driver (such as memory mapped display memory, `GUIDRV_Lin` and others) the use of Memory Devices has a slight impact on performance because the device needs to be drawn as well.

If 'banding' is needed, the used time to draw a window increases with the number of bands. The more memory available for Memory Devices, the better the performance.

## 7.6.7 Performance gain with Static Memory Devices

As mentioned above, static memory devices are able to affect the performance significantly. If a window with this flag needs to be drawn, emWin first checks if a static memory device exists for that window. If not, it will be created first and the content of the window/widget will be (pre)rendered in that memory device. When moving such a window, only the already existing memory needs to be drawn at the new position instead of invalidating and redrawing the content again.

### 7.6.7.1 Memory requirement

This option often improves performance significantly, but it also needs a large amount of RAM. The more complex the process of drawing of a window/widget is, the greater is the performance gain which can be achieved when using this option. But please note that each static memory device requires 4 bytes of memory for each pixel. That means using this option only makes sense, if a couple of MBytes are available for emWin.

### 7.6.7.2 Example

We measured the performance gain with the following screens:

We measured the following performance gain for swiping operations when enabling static memory devices:

	CPU-Load	Frames per second
Static memory devices <b>disabled</b>	57%	8
Static memory devices <b>enabled</b>	<b>24%</b>	<b>16</b>

We used an iMXRT1060 with the Pixel Pipeline (PXP) accelerator enabled for drawing 32 bpp memory devices for this test. It shows that the CPU load is halved and the framerate is doubled with this option. The total performance gain here is therefore around a factor of approx. 4.4.

## 7.6.8 Basic functions

The following routines are those that are normally called when using Memory Devices. Basic usage is rather simple:

1. Create the Memory Device (using `GUI_MEMDEV_Create()`).
2. Activate it (using `GUI_MEMDEV_Select()`).
3. Execute drawing operations.
4. Copy the result into the display (using `GUI_MEMDEV_CopyToLCD()`).
5. Delete the Memory Device if you no longer need it (using `GUI_MEMDEV_Delete()`).
6. De-select the Memory Device (using `GUI_MEMDEV_Select(0)` or with the return value of the previous call of `GUI_MEMDEV_Select()`).

## 7.6.9 In order to be able to use Memory Devices...

Memory Devices are enabled by default. In order to optimize performance of the software, support for Memory Devices can be switched off in the configuration file `GUIConf.h` by including the following line:

```
#define GUI_SUPPORT_MEMDEV 0
```

If this line is in the configuration file and you want to use Memory Devices, either delete the line or change the define to 1.

## 7.6.10 MultiLayer / MultiDisplay configuration

As explained earlier in this chapter Memory Devices "compatible" to the display needs to have the same or a higher color depth as the display. When creating a Memory Device compatible to the display emWin "knows" the color depth of the currently selected layer/display and automatically uses the lowest color depth.

## 7.6.11 Configuration options

Type	Macro	Default	Description
B	GUI_USE_MEMDEV_1BPP_FOR_SCREEN	1	Enables the use of 1bpp Memory Devices with displays of 1bpp color depth.

### GUI\_USE\_MEMDEV\_1BPP\_FOR\_SCREEN

On systems with a display color depth  $\leq$  8bpp the default color depth of Memory Devices compatible to the display is 8bpp. To enable the use of 1bpp Memory Devices with displays of 1bpp color depth the following line should be added to the configuration file `GUIConf.h`:

```
#define GUI_USE_MEMDEV_1BPP_FOR_SCREEN 0
```

## 7.6.12 Memory Device API

The table below lists the available routines of the emWin Memory Device API. All functions are listed in alphabetical order within their respective categories. Detailed descriptions of the routines can be found in the sections that follow.

### Functions

Routine	Description
Basic functions	
<code>GUI_MEMDEV_Clear()</code>	Marks the entire contents of a Memory Device as "unchanged".
<code>GUI_MEMDEV_ClearAlpha()</code>	Clears all alpha values in the given memory device.
<code>GUI_MEMDEV_CopyFromLCD()</code>	Reads back the content of the display and stores it in the given Memory Device.
<code>GUI_MEMDEV_CopyRect()</code>	Copies a rectangular area from one memory device to another one.
<code>GUI_MEMDEV_CopyToLCD()</code>	Copies the contents of a Memory Device from memory to the LCD.
<code>GUI_MEMDEV_CopyToLCDAA()</code>	Copies the contents of a Memory Device (antialiased) to the LCD.
<code>GUI_MEMDEV_CopyToLCDAt()</code>	Copies the contents of a Memory Device to the LCD at the given position.

Routine	Description
<code>GUI_MEMDEV_Create()</code>	Creates the Memory Device (first step).
<code>GUI_MEMDEV_CreateCopy()</code>	This function creates a copy from a memory device.
<code>GUI_MEMDEV_CreateEx()</code>	Creates a Memory Device.
<code>GUI_MEMDEV_CreateFixed()</code>	Creates a Memory Device with dedicated color depth color conversion.
<code>GUI_MEMDEV_CreateFixed32()</code>	Creates a 32bpp Memory Device.
<code>GUI_MEMDEV_Delete()</code>	Deletes a Memory Device.
<code>GUI_MEMDEV_DrawPerspectiveX()</code>	Draws the given Memory Device perspective distorted into the current selected device.
<code>GUI_MEMDEV_GetBitsPerPixel()</code>	Returns the color depth of given Memory Device.
<code>GUI_MEMDEV_GetDataPtr()</code>	Returns a pointer to the data area (image area) of a Memory Device.
<code>GUI_MEMDEV_GetSelMemdev()</code>	Returns a handle to the currently selected Memory Device.
<code>GUI_MEMDEV_GetXSize()</code>	Returns the X-size (width) of a Memory Device.
<code>GUI_MEMDEV_GetYSize()</code>	Returns the Y-size (height) of a Memory Device in pixels.
<code>GUI_MEMDEV_MarkDirty()</code>	Marks a rectangle area as dirty.
<code>GUI_MEMDEV_PunchOutDevice()</code>	Punches out a shape of a Memory Device defined by a 8bpp mask Memory Device.
<code>GUI_MEMDEV_ReduceYSize()</code>	Reduces the Y-size of a Memory Device.
<code>GUI_MEMDEV_Rotate()</code>	Rotates and scales a Memory Device and writes the result into a Memory Device using the 'nearest neighbor' method.
<code>GUI_MEMDEV_RotateAlpha()</code>	Rotates and scales a Memory Device and blends in the result into a Memory Device using the 'nearest neighbor' method and the given alpha value.
<code>GUI_MEMDEV_RotateHQ()</code>	Rotates and scales a Memory Device and writes the result into a Memory Device using the 'high quality' method.
<code>GUI_MEMDEV_RotateHQAlpha()</code>	Rotates and scales a Memory Device and blends in the result into a Memory Device using the 'high quality' method and the given alpha value.
<code>GUI_MEMDEV_RotateHQHR()</code>	Rotates and scales a Memory Device and writes the result into a Memory Device using the 'high quality' as well as the 'high resolution' method.
<code>GUI_MEMDEV_RotateHQT()</code>	Rotates and scales a Memory Device and writes the result into a Memory Device using the 'high quality' method. (Optimized for images with a large amount of transparent pixels)
<code>GUI_MEMDEV_RotateHR()</code>	Rotates and scales a Memory Device and writes the result into a Memory Device using the 'high resolution' method.

Routine	Description
<code>GUI_MEMDEV_Select()</code>	Activates a Memory Device (or activates LCD if handle is 0).
<code>GUI_MEMDEV_SerializeBMP()</code>	Creates a BMP file from the given Memory Device.
<code>GUI_MEMDEV_SerializeExBMP()</code>	Creates a BMP file from a given rectangular area of a memory device.
<code>GUI_MEMDEV_SetOrg()</code>	Changes the origin of the Memory Device on the LCD.
<code>GUI_MEMDEV_Write()</code>	Writes the content of the given Memory Device into the currently selected device.
<code>GUI_MEMDEV_WriteAlpha()</code>	Writes the content of the given Memory Device into the currently selected device using alpha blending.
<code>GUI_MEMDEV_WriteAlphaAt()</code>	Writes the content of the given Memory Device into the currently selected device at the specified position using alpha blending.
<code>GUI_MEMDEV_WriteAt()</code>	Writes the content of the given Memory Device into the currently selected device at the specified position.
<code>GUI_MEMDEV_WriteEx()</code>	Writes the content of the given Memory Device into the currently selected device at position (0, 0) using alpha blending and scaling.
<code>GUI_MEMDEV_WriteExAt()</code>	Writes the content of the given Memory Device into the currently selected device at the specified position using alpha blending and scaling.
<code>GUI_MEMDEV_WriteOpaque()</code>	Writes the content of the given Memory Device into the currently selected device.
<code>GUI_MEMDEV_WriteOpaqueAt()</code>	Writes the content of the given Memory Device into the currently selected device at the specified position.
<code>GUI_SelectLCD()</code>	Selects the LCD as target for drawing operations.
<b>Banding Memory Device</b>	
<code>GUI_MEMDEV_Draw()</code>	Use a Memory Device for drawing.
<b>Auto device object functions</b>	
<code>GUI_MEMDEV_CreateAuto()</code>	Creates an auto device object.
<code>GUI_MEMDEV_DeleteAuto()</code>	Deletes an auto device object.
<code>GUI_MEMDEV_DrawAuto()</code>	Executes a specified drawing routine using a banding Memory Device.
<b>Measurement device object functions</b>	
<code>GUI_MEASDEV_ClearRect()</code>	Clears the measurement rectangle.
<code>GUI_MEASDEV_Create()</code>	Creates a measurement device.
<code>GUI_MEASDEV_Delete()</code>	Deletes a measurement device.
<code>GUI_MEASDEV_GetRect()</code>	Retrieves the measurement result.
<code>GUI_MEASDEV_Select()</code>	Selects a measurement device as target for drawing operations.
<b>Animation functions</b>	

Routine	Description
<code>GUI_MEMDEV_FadeInDevices()</code>	Performs fading in one device over another Memory Device.
<code>GUI_MEMDEV_FadeOutDevices()</code>	Performs fading out one device overlaying another Memory Device.
<code>GUI_MEMDEV_SetAnimationCallback()</code>	Sets a user defined callback function to be called while animations are processed.
<code>GUI_MEMDEV_SetTimePerFrame()</code>	Sets the minimum time used for one animation frame.
<b>Animation functions (Window Manager required)</b>	
<code>GUI_MEMDEV_FadeInWindow()</code>	Fades in a window by animating the alpha value from transparent to opaque.
<code>GUI_MEMDEV_FadeOutWindow()</code>	Fades out a window animating the alpha value from opaque to transparent.
<code>GUI_MEMDEV_MoveInWindow()</code>	Moves a window into the screen.
<code>GUI_MEMDEV_MoveOutWindow()</code>	Moves a window out of the screen.
<code>GUI_MEMDEV_ShiftInWindow()</code>	Shifts a Window in a specified direction into the screen to its actual position.
<code>GUI_MEMDEV_ShiftOutWindow()</code>	Shifts a Window in a specified direction out of the screen from its actual position.
<code>GUI_MEMDEV_SwapWindow()</code>	Swaps a window with the old content of the target area.
<b>Blending, Blurring and Dithering functions</b>	
<code>GUI_MEMDEV_BlendColor32()</code>	Blends a window with the given color and blending intensity.
<code>GUI_MEMDEV_CreateBlurredDevice32()</code>	Creates a blurred copy of the given Memory Device using the currently set blurring function.
<code>GUI_MEMDEV_CreateBlurredDevice32HQ()</code>	Creates a blurred copy of the given Memory Device at high quality.
<code>GUI_MEMDEV_CreateBlurredDevice32LQ()</code>	Creates a blurred copy of the given Memory Device at low quality.
<code>GUI_MEMDEV_Dither32()</code>	The function dithers the given memory device using the given fixed palette mode.
<code>GUI_MEMDEV_SetBlurHQ()</code>	Sets the blurring behavior of the function <code>GUI_MEMDEV_CreateBlurredDevice32()</code> to HQ.
<code>GUI_MEMDEV_SetBlurLQ()</code>	Sets the blurring behavior of the function <code>GUI_MEMDEV_CreateBlurredDevice32()</code> to LQ.
<b>Blending and Blurring functions (Window Manager required)</b>	
<code>GUI_MEMDEV_BlendWinBk()</code>	Blends the background of a window.
<code>GUI_MEMDEV_BlurAndBlendWinBk()</code>	Blurs and blends the background of a window.
<code>GUI_MEMDEV_BlurWinBk()</code>	Blurs the background of a window.
<b>Setting up multiple buffering for animation functions</b>	
<code>GUI_MEMDEV_MULTIBUF_Enable()</code>	Enable use of multiple buffers for memory device animation functions.
<b>Memory bitmaps</b>	

Routine	Description
<code>GUI_MBITMAP_Create()</code>	Create a memory bitmap from local resources.
<code>GUI_MBITMAP_CreateEx()</code>	Create a memory bitmap from external resources.
<code>GUI_MBITMAP_CreateUser()</code>	Create a memory bitmap with more options from local resources.
<code>GUI_MBITMAP_CreateUserEx()</code>	Create a memory bitmap with more options from external resources.
<code>GUI_MBITMAP_Delete()</code>	Delete a memory bitmap.
<code>GUI_MBITMAP_SetColorFormat()</code>	Set a default color format to be used.

## Defines

Group of defines	Description
<code>Color conversion routines</code>	Defines the desired color conversion routine for a memory device.
<code>Direction symbols</code>	Direction in which a window should be moved to using memory devices.
<code>Memory device color depths</code>	Available color depths for fixed memory devices.
<code>Memory device flags</code>	Flags to be used for the creation of a memory device.

## 7.6.12.1 Basic functions

### 7.6.12.1.1 GUI\_MEMDEV\_Clear()

#### Description

Marks the entire contents of a Memory Device as “unchanged”.

#### Prototype

```
void GUI_MEMDEV_Clear(GUI_MEMDEV_Handle hMem);
```

#### Parameters

Parameter	Description
<code>hMem</code>	Handle to a Memory Device.

#### Additional information

The next drawing operation with `GUI_MEMDEV_CopyToLCD()` will then write only the bytes modified between `GUI_MEMDEV_Clear()` and `GUI_MEMDEV_CopyToLCD()`.

### 7.6.12.1.2 GUI\_MEMDEV\_ClearAlpha()

#### Description

Clears all alpha values in the given Memory Device with the help of an 1bpp Memory Device mask.

#### Prototype

```
int GUI_MEMDEV_ClearAlpha(GUI_MEMDEV_Handle hMemData,
                          GUI_MEMDEV_Handle hMemMask);
```

#### Parameters

Parameter	Description
<a href="#">hMemData</a>	Handle to a Memory Device. Must be a 32bpp Memory Device.
<a href="#">hMemMask</a>	Optional handle to a Memory Device mask. Must be an 1bpp Memory Device with the same size as the <a href="#">hMemData</a> handle.

#### Return value

0        on success  
1        on error.

#### Additional information

The Memory Device mask must have the same dimensions as the given [hMemData](#) Memory Device. To use the Memory Device mask, an area has to be specified where the alpha values should be cleared. To do so basic drawing functions should be used. The function sets all pixels of the data memory device to opaque, which have the index value 1 in the mask memory device. If [hMemMask](#) is 0, the alpha values of the whole memory device will be set to opaque. No transparency remains then.

#### Example

```
#include "GUI.h"
/*****
 *
 *      MainTask
 */
void MainTask(void) {
    GUI_MEMDEV_Handle hMemData;
    GUI_MEMDEV_Handle hMemMask;
    GUI_Init();
    //
    // Background
    //
    GUI_SetBkColor(GUI_DARKBLUE);
    GUI_Clear();
    GUI_DrawGradientV(0, 0, 320, 240, GUI_BLUE, GUI_RED);
    //
    // Mask device
    //
    hMemMask = GUI_MEMDEV_CreateFixed(0, 0, 320, 240, GUI_MEMDEV_NOTRANS,
                                     GUI_MEMDEV_APILIST_1, GUICC_1);

    GUI_MEMDEV_Select(hMemMask);
    GUI_SetPenSize(8);
    GUI_DrawLine(0, 240, 320, 0);
    GUI_DrawLine(0, 0, 320, 240);
    GUI_MEMDEV_Select(0);
    //
    // Data Device
    //
```



```

hMemData = GUI_MEMDEV_CreateFixed(0, 0, 320, 240, GUI_MEMDEV_NOTRANS,
                                  GUI_MEMDEV_APILIST_32, GUICC_8888);

GUI_MEMDEV_Select(hMemData);
GUI_Clear();
GUI_DrawGradientH(0, 0, 320, 240, GUI_BLUE, GUI_TRANSPARENT);
GUI_MEMDEV_Select(0);
//
// Calling GUI_MEMDEV_ClearAlpha()
//
GUI_MEMDEV_ClearAlpha(hMemData, hMemMask);
//
// Result
//
GUI_MEMDEV_Write(hMemData);
while (1) {
    GUI_Delay(100);
}
}

```

## Screenshots

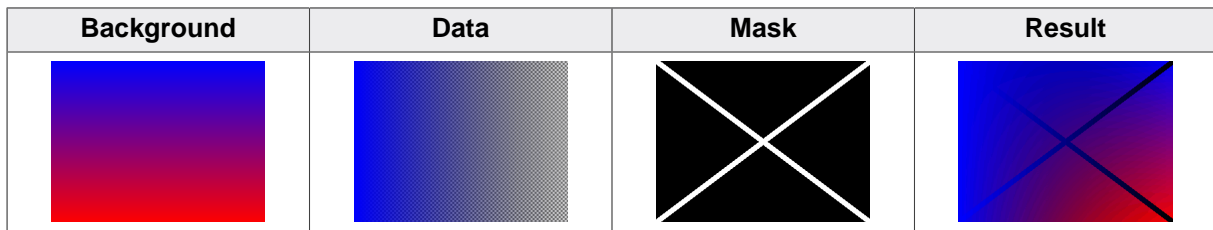

### 7.6.12.1.3 GUI\_MEMDEV\_CopyFromLCD()

#### Description

Reads back the content of the display and stores it in the given Memory Device.

#### Prototype

```
void GUI_MEMDEV_CopyFromLCD(GUI_MEMDEV_Handle hMem);
```

#### Parameters

Parameter	Description
<a href="#">hMem</a>	Handle to a Memory Device.

### 7.6.12.1.4 GUI\_MEMDEV\_CopyRect()

#### Description

Copies a rectangular area from one memory device to another one.

#### Prototype

```
int GUI_MEMDEV_CopyRect(
    GUI_MEMDEV_Handle hMemSrc,
    GUI_MEMDEV_Handle hMemDst,
    const GUI_RECT * pRect,
    int xDst,
    int yDst);
```

#### Parameters

Parameter	Description
<a href="#">hMemSrc</a>	Handle to a Memory Device we copy from.
<a href="#">hMemDst</a>	Handle to a Memory Device we copy to.
<a href="#">pRect</a>	<b>in</b> A rectangle which defines the area to be copied. Coordinates must be relative to the memory device(s).
<a href="#">xDst</a>	The x coordinate the rectangle should be copied to in the destination device.
<a href="#">yDst</a>	The y coordinate the rectangle should be copied to in the destination device.

#### Return value

0 On success.  
1 On error.

#### Additional information

It is allowed to pass the same memory device handle to [hMemSrc](#) and [hMemDst](#).

### 7.6.12.1.5 GUI\_MEMDEV\_CopyToLCD()

#### Description

Copies the contents of a Memory Device from memory to the LCD.

#### Prototype

```
void GUI_MEMDEV_CopyToLCD(GUI_MEMDEV_Handle hMem);
```

#### Parameters

Parameter	Description
<a href="#">hMem</a>	Handle to a Memory Device.

#### Additional information

This function ignores the clipping area of the Window Manager as well as the alpha channel. Therefore using this function from within a paint event is not recommended. In order to display a Memory Device regarding the clipping area as well as the alpha channel, the function `GUI_MEMDEV_WriteAt()` should be used instead.

### 7.6.12.1.6 GUI\_MEMDEV\_CopyToLCDAA()

#### Description

Copies the contents of a Memory Device (antialiased) to the LCD.

#### Prototype

```
void GUI_MEMDEV_CopyToLCDAA(GUI_MEMDEV_Handle hMem);
```

#### Parameters

Parameter	Description
hMem	Handle to a Memory Device.

#### Additional information

The device data is handled as antialiased data. A matrix of 2x2 pixels is converted to 1 pixel. The intensity of the resulting pixel depends on how many pixels are set in the matrix.

#### Example

Creates a Memory Device and selects it for output. A large font is then set and a text is written to the Memory Device:

```
GUI_MEMDEV_Handle hMem = GUI_MEMDEV_Create(0,0,60,32);  
GUI_MEMDEV_Select(hMem);  
GUI_SetFont(&GUI_Font32B_ASCII);  
GUI_DispString("Text");  
GUI_MEMDEV_CopyToLCDAA(hMem);
```

#### Screenshot of above example



### 7.6.12.1.7 GUI\_MEMDEV\_CopyToLCDAt()

#### Description

Copies the contents of a Memory Device to the LCD at the given position.

#### Prototype

```
void GUI_MEMDEV_CopyToLCDAt (GUI_MEMDEV_Handle hMem,  
                             int x,  
                             int y);
```

#### Parameters

Parameter	Description
<code>hMem</code>	Handle to a Memory Device.
<code>x</code>	Position in X
<code>y</code>	Position in Y

### 7.6.12.1.8 GUI\_MEMDEV\_Create()

#### Description

Creates a Memory Device.

#### Prototype

```
GUI_MEMDEV_Handle GUI_MEMDEV_Create(int x0,  
                                     int y0,  
                                     int xSize,  
                                     int ySize);
```

#### Parameters

Parameter	Description
x0	X-position of the Memory Device.
y0	Y-position of the Memory Device.
xSize	X-size of the Memory Device.
ySize	Y-size of the Memory Device.

#### Return value

Handle of the created Memory Device. If the routine fails the return value is 0.

### 7.6.12.1.9 GUI\_MEMDEV\_CreateCopy()

#### Description

This function creates a copy from a memory device.

#### Prototype

```
GUI_MEMDEV_Handle GUI_MEMDEV_CreateCopy(GUI_MEMDEV_Handle hMemSrc);
```

#### Parameters

Parameter	Description
<a href="#">hMemSrc</a>	Handle of the memory device to be copied.

#### Return value

The return value is a handle of a memory device containing the copy of [hMemSrc](#). If there is not enough memory to create a memory device as copy, this function returns 0.



### 7.6.12.1.10 GUI\_MEMDEV\_CreateEx()

#### Description

Creates a Memory Device.

#### Prototype

```
GUI_MEMDEV_Handle GUI_MEMDEV_CreateEx(int x0,  
                                       int y0,  
                                       int xSize,  
                                       int ySize,  
                                       int Flags);
```

#### Parameters

Parameter	Description
<code>x0</code>	x-position of the Memory Device.
<code>y0</code>	y-position of the Memory Device.
<code>xSize</code>	x-size of the Memory Device.
<code>ySize</code>	y-size of the Memory Device.
<code>Flags</code>	A list of permitted values can be found under <i>Memory device flags</i> on page 3017.

#### Return value

Handle of the created Memory Device. If the routine fails the return value is 0.

### 7.6.12.1.11 GUI\_MEMDEV\_CreateFixed()

#### Description

Creates a Memory Device with dedicated color depth color conversion.

#### Prototype

```
GUI_MEMDEV_Handle GUI_MEMDEV_CreateFixed(    int          x0,
                                             int          y0,
                                             int          xSize,
                                             int          ySize,
                                             int          Flags,
                                             const GUI_DEVICE_API * pDeviceAPI,
                                             const LCD_API_COLOR_CONV * pColorConvAPI);
```

#### Parameters

Parameter	Description
<code>x0</code>	x-position of the Memory Device.
<code>y0</code>	y-position of the Memory Device.
<code>xSize</code>	x-size of the Memory Device.
<code>ySize</code>	y-size of the Memory Device.
<code>Flags</code>	A list of permitted values can be found under <i>Memory device flags</i> on page 3017.
<code>pMemDevAPI</code>	A list of permitted color depths can be found under <i>Memory device color depths</i> on page 3016.
<code>pColorConvAPI</code>	A list of permitted color conversion routines can be found under <i>Color conversion routines</i> on page 3014.

#### Return value

Handle of the created Memory Device. If the routine fails the return value is 0.

#### Additional information

This function can be used if a Memory Device with a specified color conversion should be created. This could make sense if for example some items should be printed on a printer device. The `Sample` folder contains the code example `MEMDEV_Printing.c` which shows how to use the function to print something in 1bpp color conversion mode.

#### Example

The following example shows how to create a Memory Device with 1bpp color depth:

```
GUI_MEMDEV_Handle hMem;
hMem = GUI_MEMDEV_CreateFixed(0, 0, 128, 128, 0,
                             GUI_MEMDEV_APILIST_1, // Used API list
                             GUI_COLOR_CONV_1);
// Black/white color conversion
GUI_MEMDEV_Select(hMem);
```

### 7.6.12.1.12 GUI\_MEMDEV\_CreateFixed32()

#### Description

Creates a Memory Device with a color depth of 32bpp and GUICC\_8888 color conversion.

#### Prototype

```
GUI_MEMDEV_Handle GUI_MEMDEV_CreateFixed32(int x0,  
                                           int y0,  
                                           int xSize,  
                                           int ySize);
```

#### Parameters

Parameter	Description
<code>x0</code>	x-position of the Memory Device.
<code>y0</code>	y-position of the Memory Device.
<code>xSize</code>	x-size of the Memory Device.
<code>ySize</code>	y-size of the Memory Device.

#### Return value

Handle to the created Memory Device. If the routine fails the return value is 0.

#### Additional information

This function makes it more easy to create a 32 bpp memory device which is often required.

### 7.6.12.1.13 GUI\_MEMDEV\_Delete()

#### Description

Deletes a Memory Device.

#### Prototype

```
void GUI_MEMDEV_Delete(GUI_MEMDEV_Handle hMemDev);
```

#### Parameters

Parameter	Description
<a href="#">hMem</a>	Handle to the Memory Device which has to be deleted.

### 7.6.12.1.14 GUI\_MEMDEV\_DrawPerspectiveX()

#### Description

Draws the given Memory Device perspectively distorted into the currently selected device.

#### Prototype

```
void GUI_MEMDEV_DrawPerspectiveX(GUI_MEMDEV_Handle hMem,
                                int                x,
                                int                y,
                                int                h0,
                                int                h1,
                                int                dx,
                                int                dy);
```

#### Parameters

Parameter	Description
<code>hMem</code>	Handle to source Memory Device with the image to be drawn.
<code>x</code>	Horizontal start position in pixels.
<code>y</code>	Vertical start position in pixels.
<code>h0</code>	Height of the leftmost edge of the image to be drawn.
<code>h1</code>	Height of the rightmost edge of the image to be drawn.
<code>dx</code>	Width of the image to be drawn.
<code>dy</code>	Position in <code>y</code> from the topmost pixel at the right relative to the topmost pixel at the left.

The picture below explains the parameters more detailed:

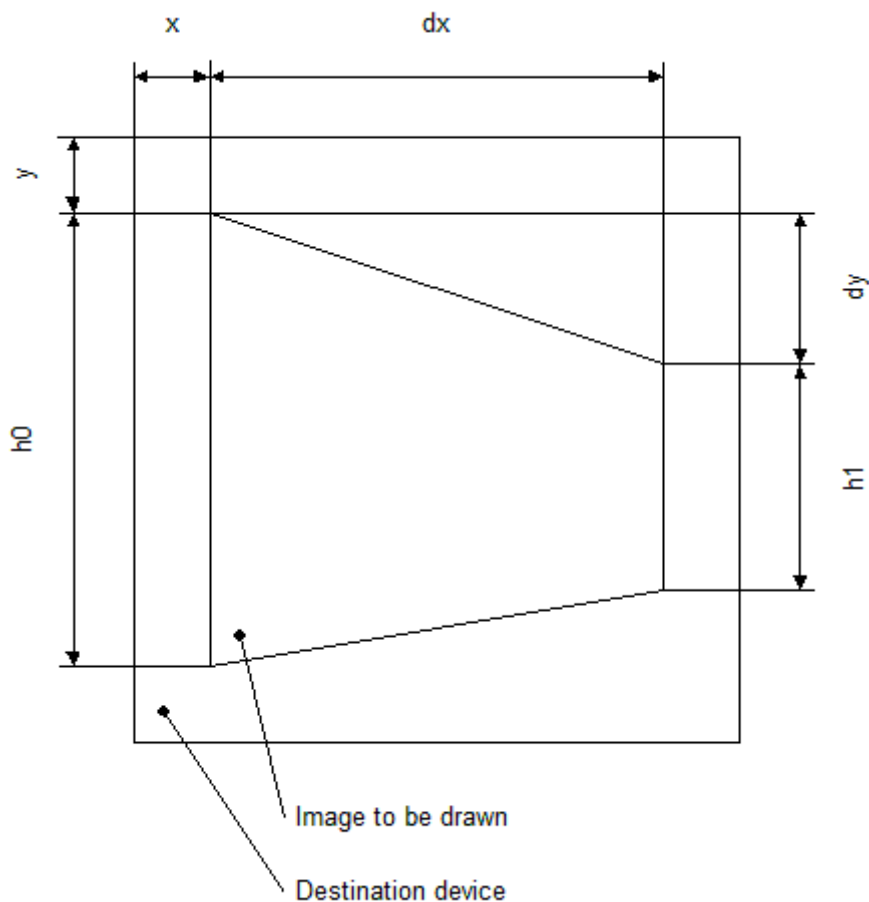

## Additional information

The function draws the contents of the given Memory Device into the currently selected device. The origin of the source device should be (0, 0). Size and distortion of the new image is defined by the parameters `dx`, `dy`, `h0` and `h1`. Note that the function currently only works with Memory Devices with 32-bpp color depth and a system color depth of 32 bpp.

## Example

The following example shows how to use the function:

```
GUI_MEMDEV_Handle hMem0, hMem1, hMem2;
hMem0 = GUI_MEMDEV_CreateFixed(0, 0, 150, 150, GUI_MEMDEV_NOTRANS,
                               GUI_MEMDEV_APILIST_32,
                               GUI_COLOR_CONV_888);
hMem1 = GUI_MEMDEV_CreateFixed(0, 0, 75, 150, GUI_MEMDEV_HASTRANS,
                               GUI_MEMDEV_APILIST_32,
                               GUI_COLOR_CONV_888);
hMem2 = GUI_MEMDEV_CreateFixed(0, 0, 75, 150, GUI_MEMDEV_HASTRANS,
                               GUI_MEMDEV_APILIST_32,
                               GUI_COLOR_CONV_888);

GUI_MEMDEV_Select(hMem0);
GUI_JPEG_Draw(_aJPEG, sizeof(_aJPEG), 0, 0);
GUI_MEMDEV_Select(hMem1);
GUI_MEMDEV_DrawPerspectiveX(hMem0, 0, 0, 150, 110, 75, 20);
GUI_MEMDEV_Select(hMem2);
GUI_MEMDEV_DrawPerspectiveX(hMem0, 0, 20, 110, 150, 75, -20);
GUI_MEMDEV_CopyToLCDAt(hMem0, 0, 10);
GUI_MEMDEV_CopyToLCDAt(hMem1, 160, 10);
GUI_MEMDEV_CopyToLCDAt(hMem2, 245, 10);
```

## Screenshot of above example

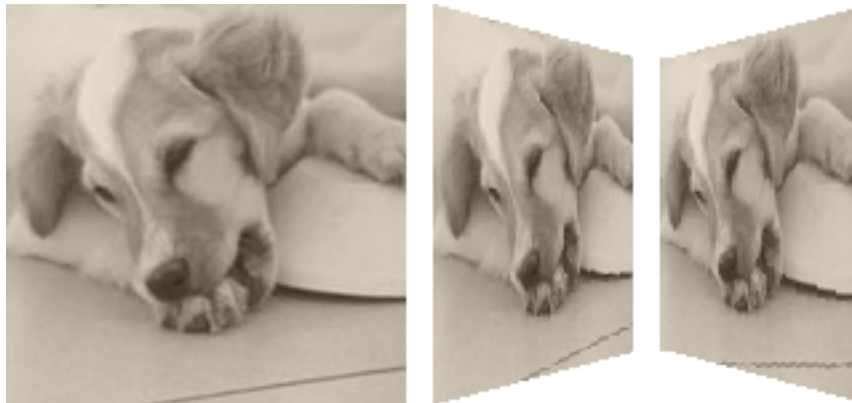

### 7.6.12.1.15 GUI\_MEMDEV\_GetBitsPerPixel()

#### Description

Returns the color depth of given Memory Device.

#### Prototype

```
int GUI_MEMDEV_GetBitsPerPixel(GUI_MEMDEV_Handle hMemDev);
```

#### Parameters

Parameter	Description
<a href="#">hMemDev</a>	Handle to the Memory Device which color depths should be retrieved.

#### Return value

Bits per pixel of the given Memory Device.

### 7.6.12.1.16 GUI\_MEMDEV\_GetDataPtr()

#### Description

Returns a pointer to the data area (image area) of a Memory Device. This data area can then be manipulated without the use of GUI functions; it can for example be used as output buffer for a JPEG or video decompression routine.

#### Prototype

```
void *GUI_MEMDEV_GetDataPtr(GUI_MEMDEV_Handle hMem);
```

#### Parameters

Parameter	Description
hMem	Handle to Memory Device.

#### Return value

Data pointer to the Device's data area. NULL on error.

#### Additional information

The device data is stored from the returned address onwards. An application modifying this data has to take extreme caution that it does not overwrite memory outside of this data area.

#### Note

Allocating dynamic memory could cause invalid data pointers!

It should be kept sure, that no memory is allocated during the pointer is used. Allocating memory could cause invalid pointers because of memory cleaning operations.

#### Organization of the data area

The pixels are stored in the mode "native" to the display (or layer) for which they are intended. For layers with 8 bpp or less, 8 bits (1 byte) are used per pixel; for layers with more than 8 and less or equal 16 bpp, a 16 bit value (U16) is used for one pixel.

The memory is organized in reading order which means: First byte (or U16), stored at the start address, represents the color index of the pixel in the upper left corner (y=0, x=0); the next pixel, stored right after the first one, is the one to the left at (y=0, x=1). (Unless the Memory Device area is only 1 pixel wide).

The next line is stored right after the first line in memory, without any kind of padding. Endian mode is irrelevant, it is assumed that 16 bit units are accessed as 16 bit units and not as 2 separate bytes.

The data area is comprised of  $xSize * ySize$  pixels, so  $xSize * ySize$  bytes for 8bpp or lower Memory Devices,  $2 * xSize * ySize$  bytes (accessed as  $xSize * ySize$  units of 16 bits) for 16 bpp Memory Devices.



### 7.6.12.1.17 GUI\_MEMDEV\_GetSelMemdev()

#### Description

Returns a handle to the currently selected Memory Device.

#### Prototype

```
GUI_MEMDEV_Handle GUI_MEMDEV_GetSelMemdev(void);
```

#### Return value

Handle of the currently selected Memory Device. 0 if no device is selected.

### 7.6.12.1.18 GUI\_MEMDEV\_GetXSize()

#### Description

Returns the X-size (width) of a Memory Device.

#### Prototype

```
int GUI_MEMDEV_GetXSize(GUI_MEMDEV_Handle hMem);
```

#### Parameters

Parameter	Description
<a href="#">hMem</a>	Handle to Memory Device.

#### Return value

X-size of Memory Device.

### 7.6.12.1.19 GUI\_MEMDEV\_GetYSize()

#### Description

Returns the Y-size (height) of a Memory Device in pixels.

#### Prototype

```
int GUI_MEMDEV_GetYSize(GUI_MEMDEV_Handle hMem);
```

#### Parameters

Parameter	Description
<a href="#">hMem</a>	Handle to Memory Device.

#### Return value

Y-size of Memory Device.

### 7.6.12.1.20 GUI\_MEMDEV\_MarkDirty()

#### Description

Marks a rectangle area as dirty.

#### Prototype

```
void GUI_MEMDEV_MarkDirty(GUI_MEMDEV_Handle hMem,  
                           int x0,  
                           int y0,  
                           int x1,  
                           int y1);
```

#### Parameters

Parameter	Description
<a href="#">hMem</a>	Handle to Memory Device.
<a href="#">x0</a>	x-coordinate of the upper left corner.
<a href="#">y0</a>	y-coordinate of the upper left corner.
<a href="#">x1</a>	x-coordinate of the lower right corner.
<a href="#">y1</a>	y-coordinate of the lower right corner.

### 7.6.12.1.21 GUI\_MEMDEV\_PunchOutDevice()

#### Description

Punches out a shape of a Memory Device defined by a 8bpp mask Memory Device.

The mask device must consist of 8bpp index values which define the intensity of the pixels to be used:

- Intensity 0 means 100% transparent.
- Intensity 255 means 100% opaque.

Intensity values between 0 and 255 mean semi transparency. The behavior of the function depends on the draw mode:

- GUI\_DM\_TRANS - Pixel becomes semi transparent
- other value - Pixel is mixed with the current background color

The punching operation will be done in the given device hMemData.

#### Prototype

```
int GUI_MEMDEV_PunchOutDevice(GUI_MEMDEV_Handle hMemData,
                              GUI_MEMDEV_Handle hMemMask);
```

#### Parameters

Parameter	Description
<a href="#">hMemData</a>	Memory Device which should be punched out. Must be a 32 bit Memory Device.
<a href="#">hMemMask</a>	Handle to the Memory Device mask, which contains the intensity values.

#### Return value

0        on success  
1        on error.

#### Example

```
#include "GUI.h"
/*****
 *
 *      MainTask
 */
void MainTask(void) {
    GUI_MEMDEV_Handle hMemData;
    GUI_MEMDEV_Handle hMemMask;
    GUI_RECT          Rect;
    GUI_Init();
    //
    // Background
    //
    GUI_SetBkColor(GUI_DARKBLUE);
    GUI_Clear();
    GUI_DrawGradientV(0, 0, 99, 49, GUI_DARKGRAY, GUI_DARKBLUE);
    GUI_SetColor(GUI_WHITE);
    //
    // Mask device
    //
    hMemMask = GUI_MEMDEV_CreateFixed(0, 0, 99, 49, GUI_MEMDEV_NOTRANS,
                                     GUI_MEMDEV_APILIST_8, GUICC_8);

    GUI_SetDrawMode(GUI_DM_TRANS);
    GUI_MEMDEV_Select(hMemMask);
    GUI_SetBkColor(GUI_BLACK);
    GUI_Clear();
    GUI_AA_FillCircle(49, 24, 20);
```

```

GUI_SetPenSize(8);
GUI_DrawLine(0, 0, 99, 49);
//
// Data Device
//
hMemData = GUI_MEMDEV_CreateFixed32(0, 0, 99, 49);
GUI_MEMDEV_Select(hMemData);
GUI_SetBkColor(GUI_LIGHTGRAY);
GUI_Clear();
Rect.x0 = 6;
Rect.y0 = 0;
Rect.x1 = 99;
Rect.y1 = 49;
GUI_SetColor(GUI_DARKGRAY);
GUI_DispStringInRectEx("Punch\nme\nout!", &Rect,
                       GUI_TA_HCENTER | GUI_TA_VCENTER, 20, GUI_ROTATE_0);
//
// Result
//
GUI_MEMDEV_Select(0);
GUI_MEMDEV_PunchOutDevice(hMemData, hMemMask);
GUI_MEMDEV_Write(hMemData);
while (1) {
    GUI_Delay(100);
}
}

```

## Screenshots



### 7.6.12.1.22 GUI\_MEMDEV\_ReduceYSize()

#### Description

Reduces the Y-size of a Memory Device.

#### Prototype

```
void GUI_MEMDEV_ReduceYSize(GUI_MEMDEV_Handle hMem,  
                             int YSize);
```

#### Parameters

Parameter	Description
<code>hMem</code>	Handle to Memory Device.
<code>YSize</code>	New Y-size of the Memory Device.

#### Additional information

Changing the size of the Memory Device is more efficient than deleting and then recreating it.

**7.6.12.1.23 GUI\_MEMDEV\_Rotate()****7.6.12.1.24 GUI\_MEMDEV\_RotateAlpha()****7.6.12.1.25 GUI\_MEMDEV\_RotateHQ()****7.6.12.1.26 GUI\_MEMDEV\_RotateHQAlpha()****7.6.12.1.27 GUI\_MEMDEV\_RotateHQHR()****7.6.12.1.28 GUI\_MEMDEV\_RotateHQT()****7.6.12.1.29 GUI\_MEMDEV\_RotateHR()****General Description**

The functions rotate and scale the given source Memory Device. The source device will be rotated and scaled around its center and then shifted by the given amount of pixels. The result is saved into the given destination Memory Device. All these functions have similar postfixes containing the sequences 'HQ', 'HQT', 'HR' and 'Alpha' which are explained in the following:

**Description 'HQ'**

HQ stands for "High Quality". The functions which are named HQ use a more complex algorithm for calculating the destination pixel data. The HQ-algorithm can be used to achieve accurate results. The functions without the HQ addition use the 'nearest neighbor' method which is fast, but less accurate.

**Description 'HQT'**

HQT stands for "High Quality Transparency". The HQT algorithm improves the performance when rotating Memory Devices containing completely transparent pixels. The more completely transparent pixels the Memory Device contains, the more significant the performance boost gets. This function is still a HQ function and therefore produces results of the same accuracy.

**Description 'HR'**

HR stands for "High Resolution". The functions named HR use a precision of 8 sub-pixels. This makes it possible to display a Memory Device much more precisely on the screen.

**Description 'Alpha'**

The 'Alpha' functions allow to use an alpha value for blending in the source device into the destination device. A value between 0 and 255 can be used, where 0 means completely visible and 255 completely transparent. Of course alpha values of the source device will be considered.

**Prototypes**

```
void GUI_MEMDEV_Rotate (GUI_MEMDEV_Handle hSrc,
                       GUI_MEMDEV_Handle hDst,
                       int dx,
                       int dy,
                       int a,
                       int Mag);
```

```
void GUI_MEMDEV_RotateHQT (GUI_MEMDEV_Handle hSrc,
                           GUI_MEMDEV_Handle hDst,
                           int dx,
                           int dy,
                           int a,
                           int Mag);
```



```
void GUI_MEMDEV_RotateHQ (GUI_MEMDEV_Handle hSrc,
                          GUI_MEMDEV_Handle hDst,
                          int dx,
                          int dy,
                          int a,
                          int Mag);
```

## Parameters

Parameter	Description
<a href="#">hSrc</a>	Handle of Memory Device to be rotated and scaled.
<a href="#">hDst</a>	Handle of destination device.
<a href="#">dx</a>	Distance in pixels for shifting the image in X.
<a href="#">dy</a>	Distance in pixels for shifting the image in Y.
<a href="#">a</a>	Angle to be used for rotation in degrees * 1000.
<a href="#">Mag</a>	Magnification factor * 1000.

## Prototypes Alpha

```
void GUI_MEMDEV_RotateAlpha (GUI_MEMDEV_Handle hSrc,
                             GUI_MEMDEV_Handle hDst,
                             int dx,
                             int dy,
                             int a,
                             int Mag,
                             U8 Alpha);
```

```
void GUI_MEMDEV_RotateHQAlpha (GUI_MEMDEV_Handle hSrc,
                                GUI_MEMDEV_Handle hDst,
                                int dx,
                                int dy,
                                int a,
                                int Mag,
                                U8 Alpha);
```

## Parameters Alpha

Parameter	Description
<a href="#">hSrc</a>	Handle of Memory Device to be rotated and scaled.
<a href="#">hDst</a>	Handle of destination device.
<a href="#">dx</a>	Distance in pixels for shifting the image in X.
<a href="#">dy</a>	Distance in pixels for shifting the image in Y.
<a href="#">a</a>	Angle to be used for rotation in degrees * 1000.
<a href="#">Mag</a>	Magnification factor * 1000.
<a href="#">Alpha</a>	Alpha value to be used for blending in the device.

## Prototypes HR

```
void GUI_MEMDEV_RotateHQHR (GUI_MEMDEV_Handle hSrc,
                             GUI_MEMDEV_Handle hDst,
                             I32 dx,
                             I32 dy,
                             int a,
                             int Mag);
```

```
void GUI_MEMDEV_RotateHR (GUI_MEMDEV_Handle hSrc,
                           GUI_MEMDEV_Handle hDst,
                           I32 dx,
                           I32 dy,
                           int a,
```

`int` `Mag` ;

**Parameters HR**

Parameter	Description
<code>hSrc</code>	Handle of Memory Device to be rotated and scaled.
<code>hDst</code>	Handle of destination device.
<code>dx</code>	Distance in pixels for shifting the image in X.
<code>dy</code>	Distance in pixels for shifting the image in Y.
<code>a</code>	Angle to be used for rotation in degrees * 1000.
<code>Mag</code>	Magnification factor * 1000.

The following picture gives a more detailed impression of the parameters:

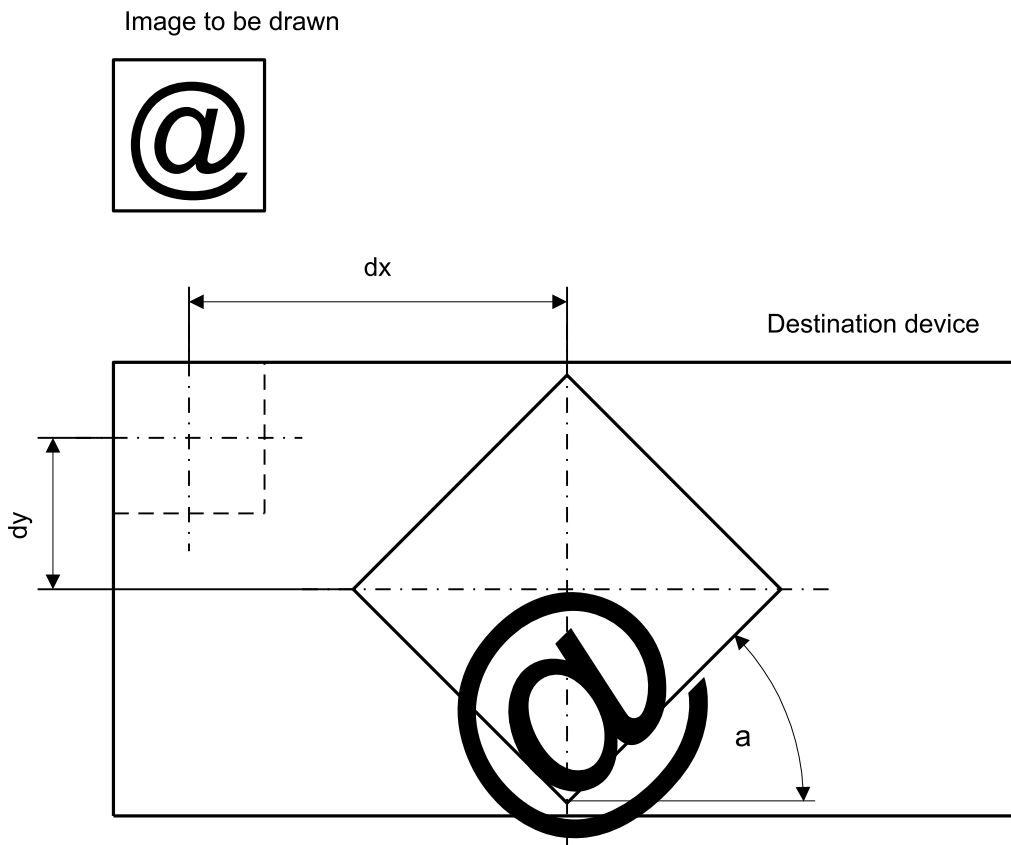

**Additional information**

Both Memory Devices, source and destination, need to be created using a **color depth of 32bpp**.

Furthermore, `GUI_MEMDEV_NOTRANS` should be used as Flags parameter when creating the devices. If it is intended to preserve transparency, the according areas in both Memory Devices need to be filled with transparency before calling a rotate function. The Sample folder contains the `MEMDEV_ZoomAndRotate.c` application which shows in detail how the function can be used.

**Performance advantage of GUI\_MEMDEV\_RotateHQT()**

The following table shows an approximation of the performance in comparison to `GUI_MEMDEV_RotateHQ()` in dependence of the percentage of transparent pixels:

Percentage of transparent pixels	Performance advantage
0%	- 3%

Percentage of transparent pixels	Performance advantage
10%	0%
50%	+ 21%
90%	+ 74%

**Example**

```

GUI_MEMDEV_Handle hMemSource;
GUI_MEMDEV_Handle hMemDest;
GUI_RECT RectSource = {0, 0, 69, 39};
GUI_RECT RectDest  = {0, 0, 79, 79};
GUI_Init();
hMemSource = GUI_MEMDEV_CreateFixed32(RectSource.x0, RectSource.y0,
                                       RectSource.x1 - RectSource.x0 + 1,
                                       RectSource.y1 - RectSource.y0 + 1);
hMemDest   = GUI_MEMDEV_CreateFixed32(RectDest.x0,  RectDest.y0,
                                       RectDest.x1  - RectDest.x0  + 1,
                                       RectDest.y1  - RectDest.y0  + 1);

GUI_MEMDEV_Select(hMemSource);
GUI_DrawGradientVEx(&RectSource, GUI_WHITE, GUI_DARKGREEN);
GUI_SetColor(GUI_BLUE);
GUI_SetFont(&GUI_Font20B_ASCII);
GUI_SetTextMode(GUI_TM_TRANS);
GUI_DispStringInRect("emWin", &RectSource, GUI_TA_HCENTER | GUI_TA_VCENTER);
GUI_DrawRectEx(&RectSource);
GUI_MEMDEV_Select(hMemDest);
GUI_Clear();
GUI_MEMDEV_Select(0);
GUI_MEMDEV_RotateHQ(hMemSource, hMemDest,
                    (RectDest.x1 - RectSource.x1) / 2,
                    (RectDest.y1 - RectSource.y1) / 2,
                    30 * 1000, // 30 degrees rotation angle
                    1000);
GUI_MEMDEV_CopyToLCDAt(hMemSource, 10, (RectDest.y1 - RectSource.y1) / 2);
GUI_MEMDEV_CopyToLCDAt(hMemDest, 100, 0);
    
```

**Screenshot of the above example using GUI\_MEMDEV\_Rotate()**



**Screenshot of the above example using GUI\_MEMDEV\_RotateHQ()**



**Screenshot of the above example using GUI\_MEMDEV\_RotateHQHR()**

This screenshot shows the 8 steps to move an anti-aliased corner one pixel to the right using sub-pixels.

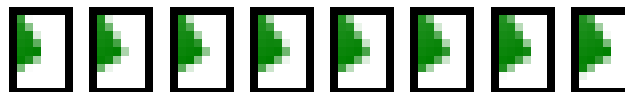

### 7.6.12.1.30 GUI\_MEMDEV\_Select()

#### Description

Activates a Memory Device (or activates LCD if handle is 0).

#### Prototype

```
GUI_MEMDEV_Handle GUI_MEMDEV_Select(GUI_MEMDEV_Handle hMemDev);
```

#### Parameters

Parameter	Description
<a href="#">hMem</a>	Handle to Memory Device.

#### Return value

Previously selected device. 0, if the display was selected.

### 7.6.12.1.31 GUI\_MEMDEV\_SerializeBMP()

#### Description

Creates a BMP file from the given Memory Device.

#### Prototype

```
void GUI_MEMDEV_SerializeBMP(GUI_MEMDEV_Handle    hDev,
                             GUI_CALLBACK_VOID_U8_P * pfSerialize,
                             void                * p);
```

#### Parameters

Parameter	Description
<code>hDev</code>	Handle to Memory Device.
<code>pfSerialize</code>	Pointer to a user defined serialization function. See prototype below.
<code>p</code>	Pointer to user defined data passed to the serialization function.

#### Additional information

To create a BMP file the color depth of the given Memory Device is used. In case it is 32bpp the resulting BMP file will consist of valid alpha data which is recognized by the Bitmap Converter.

An example for serialization can be found in the description of `GUI_BMP_Serialize()`.

#### Prototype of GUI\_CALLBACK\_VOID\_U8\_P

```
void GUI_CALLBACK_VOID_U8_P(U8    Data,
                           void * p);
```

### 7.6.12.1.32 GUI\_MEMDEV\_SerializeExBMP()

#### Description

Creates a BMP file from a given rectangular area of a memory device.

#### Prototype

```
void GUI_MEMDEV_SerializeExBMP(GUI_MEMDEV_Handle    hDev,
                               GUI_CALLBACK_VOID_U8_P * pfSerialize,
                               void                * p,
                               int                 xPos,
                               int                 yPos,
                               int                 xSize,
                               int                 ySize);
```

#### Parameters

Parameter	Description
<code>hDev</code>	Handle to Memory Device.
<code>pfSerialize</code>	Pointer to a user defined serialization function. See prototype below.
<code>p</code>	Pointer to user defined data passed to the serialization function.
<code>xPos</code>	X-position of upper left position of the rectangular area.
<code>yPos</code>	Y-position of upper left position of the rectangular area.
<code>xSize</code>	X-size of the rectangular area.
<code>ySize</code>	Y-size of the rectangular area.

#### Additional information

An example for serialization can be found in the description of `GUI_BMP_Serialize()`.

#### Prototype of GUI\_CALLBACK\_VOID\_U8\_P

```
void GUI_CALLBACK_VOID_U8_P(U8    Data,
                           void * p);
```

### 7.6.12.1.33 GUI\_MEMDEV\_SetOrg()

#### Description

Changes the origin of the Memory Device on the LCD.

#### Prototype

```
void GUI_MEMDEV_SetOrg(GUI_MEMDEV_Handle hMem,  
                       int x0,  
                       int y0);
```

#### Parameters

Parameter	Description
<a href="#">hMem</a>	Handle to Memory Device.
<a href="#">x0</a>	Horizontal position (of the upper left pixel).
<a href="#">y0</a>	Vertical position (of the upper left pixel).

#### Additional information

This routine can be helpful when the same device is used for different areas of the screen or when the contents of the Memory Device are to be copied into different areas. Changing the origin of the Memory Device is more efficient than deleting and then recreating it.

### 7.6.12.1.34 GUI\_MEMDEV\_Write()

#### Description

Writes the content of the given Memory Device into the currently selected device.

#### Prototype

```
void GUI_MEMDEV_Write(GUI_MEMDEV_Handle hMem);
```

#### Parameters

Parameter	Description
<a href="#">hMem</a>	Handle to Memory Device.

#### Additional information

In case of writing a 32 bpp memory device with alpha channel the alpha values will be considered for mixing the content of the given memory device with the content of the currently selected device.



### 7.6.12.1.35 GUI\_MEMDEV\_WriteAlpha()

#### Description

Writes the content of the given Memory Device into the currently selected device using alpha blending.

#### Prototype

```
void GUI_MEMDEV_WriteAlpha(GUI_MEMDEV_Handle hMem,  
                           int Alpha);
```

#### Parameters

Parameter	Description
<a href="#">hMem</a>	Handle to Memory Device.
<a href="#">Alpha</a>	<a href="#">Alpha</a> blending factor, 0 - 255

#### Additional information

[Alpha](#) blending means mixing 2 colors with a given intensity. This function makes it possible to write semi-transparent from one Memory Device into an other Memory Device. The [Alpha](#)-parameter specifies the intensity used when writing to the currently selected device. In case of writing a 32 bpp memory device with alpha channel the alpha values will also be considered.

### 7.6.12.1.36 GUI\_MEMDEV\_WriteAlphaAt()

#### Description

Writes the content of the given Memory Device into the currently selected device at the specified position using alpha blending.

#### Prototype

```
void GUI_MEMDEV_WriteAlphaAt(GUI_MEMDEV_Handle hMem,  
                             int Alpha,  
                             int x,  
                             int y);
```

#### Parameters

Parameter	Description
<a href="#">hMem</a>	Handle to Memory Device.
<a href="#">Alpha</a>	<a href="#">Alpha</a> blending factor, 0 - 255
<a href="#">x</a>	Position in X
<a href="#">y</a>	Position in Y

#### Additional information

See [GUI\\_MEMDEV\\_WriteAlpha\(\)](#).

### 7.6.12.1.37 GUI\_MEMDEV\_WriteAt()

#### Description

Writes the content of the given Memory Device into the currently selected device at the specified position.

#### Prototype

```
void GUI_MEMDEV_WriteAt(GUI_MEMDEV_Handle hMem,  
                        int x,  
                        int y);
```

#### Parameters

Parameter	Description
<code>hMem</code>	Handle to Memory Device.
<code>x</code>	Position in X
<code>y</code>	Position in Y

#### Additional information

(See *GUI\_MEMDEV\_Write* on page 2960)

### 7.6.12.1.38 GUI\_MEMDEV\_WriteEx()

#### Description

Writes the content of the given Memory Device into the currently selected device at position (0, 0) using alpha blending and scaling.

#### Prototype

```
void GUI_MEMDEV_WriteEx(GUI_MEMDEV_Handle hMem,  
                        int                xMag,  
                        int                yMag,  
                        int                Alpha);
```

#### Parameters

Parameter	Description
<a href="#">hMem</a>	Handle to Memory Device.
<a href="#">xMag</a>	Scaling factor for X-axis * 1000.
<a href="#">yMag</a>	Scaling factor for Y-axis * 1000.
<a href="#">Alpha</a>	<a href="#">Alpha</a> blending factor, 0 - 255.

#### Additional information

A negative scaling factor mirrors the output. Also refer to `GUI_MEMDEV_WriteExAt()` below.

### 7.6.12.1.39 GUI\_MEMDEV\_WriteExAt()

#### Description

Writes the content of the given Memory Device into the currently selected device at the specified position using alpha blending and scaling.

#### Prototype

```
void GUI_MEMDEV_WriteExAt(GUI_MEMDEV_Handle hMem,
                          int                x,
                          int                y,
                          int                xMag,
                          int                yMag,
                          int                Alpha);
```

#### Parameters

Parameter	Description
<code>hMem</code>	Handle to Memory Device.
<code>x</code>	Position in X.
<code>y</code>	Position in Y.
<code>xMag</code>	Scaling factor for X-axis * 1000.
<code>yMag</code>	Scaling factor for Y-axis * 1000.
<code>Alpha</code>	Alpha blending factor, 0 - 255.

#### Additional information

A negative scaling factor mirrors the output.

#### Example

The following example creates 2 Memory Devices: `hMem0` (40x10) and `hMem1` (80x20). A small white text is drawn at the upper left position of `hMem0` and `hMem1`. Then the function `GUI_MEMDEV_WriteEx()` writes the content of `hMem0` to `hMem1` using mirroring and magnifying:

```
GUI_MEMDEV_Handle hMem0, hMem1;
GUI_Init();
hMem0 = GUI_MEMDEV_Create(0, 0, 40, 10);
hMem1 = GUI_MEMDEV_Create(0, 0, 80, 20);
GUI_MEMDEV_Select(hMem0);
GUI_SetTextMode(GUI_TM_TRANS);
GUI_DispString("Text");
GUI_MEMDEV_Select(hMem1);
GUI_SetBkColor(GUI_RED);
GUI_Clear();
GUI_DispStringAt("Text", 0, 0);
GUI_MEMDEV_WriteExAt(hMem0, 0, 0, -2000, -2000, 160);
GUI_MEMDEV_CopyToLCD(hMem1);
```

#### Screenshot of the above example



### 7.6.12.1.40 GUI\_MEMDEV\_WriteOpaque()

#### Description

Writes the content of the given Memory Device into the currently selected device.

#### Prototype

```
void GUI_MEMDEV_WriteOpaque(GUI_MEMDEV_Handle hMem);
```

#### Parameters

Parameter	Description
<a href="#">hMem</a>	Handle to Memory Device.

#### Additional information

In case of writing a 32 bpp memory device with alpha channel the alpha values will not be changed and copied as they are. Although, the name implies that the memory device becomes fully opaque the alpha values will remain. The alpha values will be copied without mixing with the background.

### 7.6.12.1.41 GUI\_MEMDEV\_WriteOpaqueAt()

#### Description

Writes the content of the given Memory Device into the currently selected device at the specified position.

#### Prototype

```
void GUI_MEMDEV_WriteOpaqueAt(GUI_MEMDEV_Handle hMem,  
                              int x,  
                              int y);
```

#### Parameters

Parameter	Description
<a href="#">hMem</a>	Handle to Memory Device.

#### Additional information

In case of writing a 32 bpp memory device with alpha channel the alpha values will not be changed and copied as they are. Although, the name implies that the memory device becomes fully opaque the alpha values will remain. The alpha values will be copied without mixing with the background.

#### 7.6.12.1.42 GUI\_SelectLCD()

##### Description

Selects the LCD as target for drawing operations.

##### Prototype

```
void GUI_SelectLCD(void);
```



### 7.6.12.2 Example for using a Memory Device

The `Sample` folder contains the following example which shows how Memory Devices can be used:

- `MEMDEV_MemDev.c`

This example demonstrates the use of a Memory Device. Some items are written to a Memory Device and then copied to the display. Note that several other examples also make use of Memory Devices and may also be helpful to get familiar with them.

#### Screenshot of above example

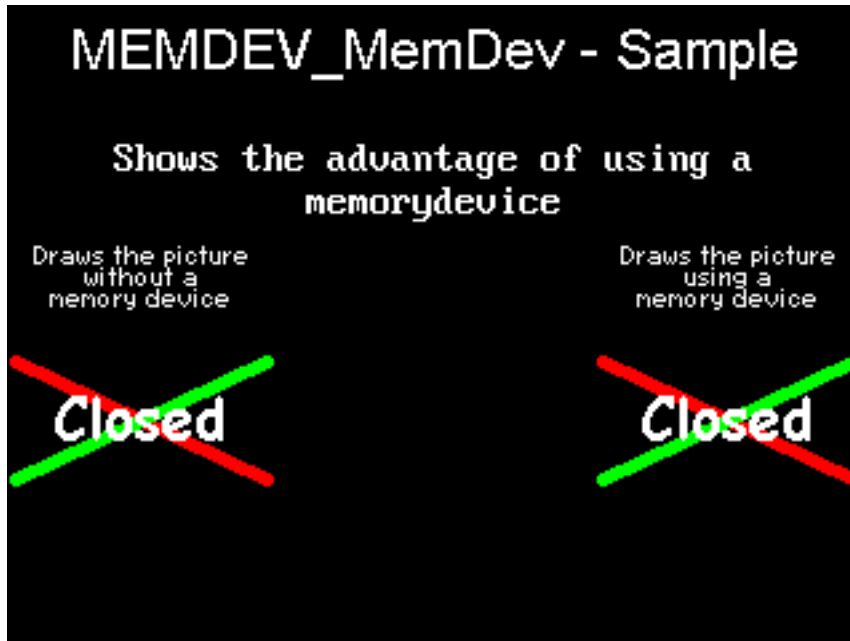

### 7.6.12.3 Banding Memory Device

A Memory Device is first filled by executing the specified drawing functions. After filling the device, the contents are drawn to the LCD. There may be not enough memory available to store the complete output area at once, depending on your configuration. A banding Memory Device divides the drawing area into bands, in which each band covers as many lines as possible with the currently available memory.

#### 7.6.12.3.1 GUI\_MEMDEV\_Draw()

##### Description

Drawing function to avoid flickering.

##### Prototype

```
int GUI_MEMDEV_Draw(GUI_RECT          * pRect,
                    GUI_CALLBACK_VOID_P * pfDraw,
                    void                * pData,
                    int                 NumLines,
                    int                 Flags);
```

##### Parameters

Parameter	Description
<a href="#">pRect</a>	Pointer to a GUI_RECT structure for the used LCD area.
<a href="#">pfDraw</a>	Pointer to a callback function for executing the drawing.
<a href="#">pData</a>	Pointer to a data structure used as parameter for the callback function.
<a href="#">NumLines</a>	0 (recommended) or number of lines for the Memory Device.
<a href="#">Flags</a>	A list of permitted values can be found under <i>Memory device flags</i> on page 3017. GUI_MEMDEV_NOTRANS is recommended.

##### Return value

0        if successful.  
1        if the routine fails.

##### Additional information

If the parameter [NumLines](#) is 0, the number of lines in each band is calculated automatically by the function. The function then iterates over the output area band by band by moving the origin of the Memory Device.

### 7.6.12.3.2 Example for using a banding Memory Device

The `Sample` folder contains the following example which shows how the function can be used:

- `MEMDEV_Banding.c`

#### Screenshot of above example



## 7.6.12.4 Auto device object functions

Memory Devices are useful when the display must be updated to reflect the movement or changing of items, since it is important in such applications to prevent the LCD from flickering. An auto device object is based on the banding Memory Device, and may be more efficient for applications such as moving indicators, in which only a small part of the display is updated at a time.

The device automatically distinguishes which areas of the display consist of fixed objects and which areas consist of moving or changing objects that must be updated. When the drawing function is called for the first time, all items are drawn. Each further call updates only the space used by the moving or changing objects. The actual drawing operation uses the banding Memory Device, but only within the necessary space. The main advantage of using an auto device object (versus direct usage of a banding Memory Device) is that it saves computation time, since it does not keep updating the entire display.

### 7.6.12.4.1 GUI\_MEMDEV\_CreateAuto()

#### Description

Creates an auto device object.

#### Prototype

```
int GUI_MEMDEV_CreateAuto(GUI_AUTODEV * pAutoDev);
```

#### Parameters

Parameter	Description
<code>pAutoDev</code>	Pointer to a GUI_AUTODEV object.

#### Return value

Currently 0, reserved for later use.

#### 7.6.12.4.2 GUI\_MEMDEV\_DeleteAuto()

##### Description

Deletes an auto device object.

##### Prototype

```
void GUI_MEMDEV_DeleteAuto(GUI_AUTODEV * pAutoDev);
```

##### Parameters

Parameter	Description
<code>pAutoDev</code>	Pointer to a GUI_AUTODEV object.

### 7.6.12.4.3 GUI\_MEMDEV\_DrawAuto()

#### Description

Executes a specified drawing routine using a banding Memory Device.

#### Prototype

```
int GUI_MEMDEV_DrawAuto(GUI_AUTODEV      * pAutoDev,
                        GUI_AUTODEV_INFO * pAutoDevInfo,
                        GUI_CALLBACK_VOID_P * pfDraw,
                        void               * pData);
```

#### Parameters

Parameter	Description
<code>pAutoDev</code>	Pointer to a GUI_AUTODEV object.
<code>pAutoDevInfo</code>	Pointer to a GUI_AUTODEV_INFO object.
<code>pfDraw</code>	Pointer to the user-defined drawing function which is to be executed.
<code>pData</code>	Pointer to a data structure passed to the drawing function.

#### Return value

0 if successful.  
1 if the routine fails.

#### Additional information

The GUI\_AUTODEV\_INFO structure contains the information about what items must be drawn by the user function:

```
typedef struct {
    char DrawFixed;
} GUI_AUTODEV_INFO;
```

DrawFixed is set to 1 if all items have to be drawn. It is set to 0 when only the moving or changing objects have to be drawn. We recommend the following procedure when using this feature:

```
typedef struct {
    GUI_AUTODEV_INFO AutoDevInfo; /* Information about what has to be drawn */
    /* Additional data used by the user function */
    ...
} PARAM;
static void Draw(void * p) {
    PARAM * pParam = (PARAM *)p;
    if (pParam->AutoDevInfo.DrawFixed) {
        /* Draw fixed background */
        ...
    }
    /* Draw moving objects */
    ...
    if (pParam->AutoDevInfo.DrawFixed) {
        /* Draw fixed foreground (if needed) */
        ...
    }
}
void main(void) {
    PARAM Param; /* Parameters for drawing routine */
    GUI_AUTODEV AutoDev; /* Object for banding Memory Device */
    /* Set/modify information for drawing routine */
    ...
}
```

```
GUI_MEMDEV_CreateAuto(&AutoDev); /* Create GUI_AUTODEV-object */
GUI_MEMDEV_DrawAuto(&AutoDev, /* Use GUI_AUTODEV-object for drawing */
    &Param.AutoDevInfo,
    &Draw,
    &Param);
GUI_MEMDEV_DeleteAuto(&AutoDev); /* Delete GUI_AUTODEV-object */
}
```

#### 7.6.12.4.4 Example for using an auto device object

The example `MEMDEV_AutoDev.c` demonstrates the use of an auto device object. It can be found as `MEMDEV_AutoDev.c`. A scale with a moving needle is drawn in the background and a small text is written in the foreground. The needle is drawn with the anti-aliasing feature of `emWin`. High-resolution anti-aliasing is used here to improve the appearance of the moving needle. For more information, see the chapter *Antialiasing* on page 3479.

#### Screenshot of above example

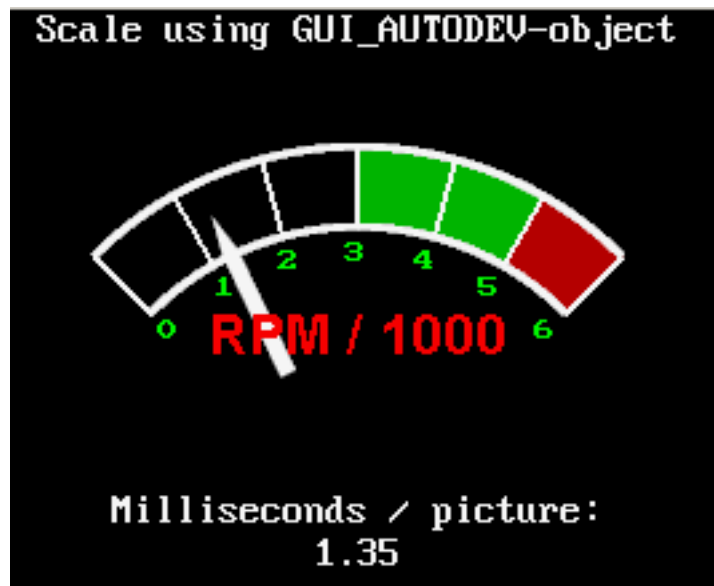

## 7.6.12.5 Measurement device object functions

Measurement devices are useful when you need to know the area used to draw something. Creating and selecting a measurement device as target for drawing operations makes it possible to retrieve the rectangle used for drawing operations.

### 7.6.12.5.1 GUI\_MEASDEV\_ClearRect()

#### Description

Call this function to clear the measurement rectangle of the given measurement device.

#### Prototype

```
void GUI_MEASDEV_ClearRect(GUI_MEASDEV_Handle hMemDev);
```

#### Parameters

Parameter	Description
<a href="#">hMem</a>	Handle to measurement device.



### 7.6.12.5.2 GUI\_MEASDEV\_Create()

#### Description

Creates a measurement device.

#### Prototype

```
GUI_MEASDEV_Handle GUI_MEASDEV_Create(void);
```

#### Return value

The handle of the measurement device.

### 7.6.12.5.3 GUI\_MEASDEV\_Delete()

#### Description

Deletes a measurement device.

#### Prototype

```
void GUI_MEASDEV_Delete(GUI_MEASDEV_Handle hMemDev);
```

#### Parameters

Parameter	Description
<a href="#">hMem</a>	Handle to measurement device.

#### 7.6.12.5.4 GUI\_MEASDEV\_GetRect()

##### Description

Retrieves the result of the drawing operations.

##### Prototype

```
void GUI_MEASDEV_GetRect(GUI_MEASDEV_Handle hMem,  
                        GUI_RECT * pRect);
```

##### Parameters

Parameter	Description
<code>hMem</code>	Handle to measurement device.
<code>pRect</code>	Pointer to GUI_RECT-structure to store result.

### 7.6.12.5.5 GUI\_MEASDEV\_Select()

#### Description

Selects a measurement device as target for drawing operations.

#### Prototype

```
void GUI_MEASDEV_Select(GUI_MEASDEV_Handle hMemDev);
```

#### Parameters

Parameter	Description
hMem	Handle to measurement device.

#### Example

The following example shows the use of a measurement device. It creates a measurement device, draws a line and displays the result of the measurement device:

```
void MainTask(void) {
    GUI_MEASDEV_Handle hMeasdev;
    GUI_RECT Rect;
    GUI_Init();
    hMeasdev = GUI_MEASDEV_Create();
    GUI_MEASDEV_Select(hMeasdev);
    GUI_DrawLine(10, 20, 30, 40);
    GUI_SelectLCD();
    GUI_MEASDEV_GetRect(hMeasdev, &Rect);
    GUI_MEASDEV_Delete(hMeasdev);
    GUI_DispString("X0:");
    GUI_DispDec(Rect.x0, 3);
    GUI_DispString(" Y0:");
    GUI_DispDec(Rect.y0, 3);
    GUI_DispString(" X1:");
    GUI_DispDec(Rect.x1, 3);
    GUI_DispString(" Y1:");
    GUI_DispDec(Rect.y1, 3);
}
```

#### Screenshot of the above example

X0:010 Y0:020 X1:030 Y1:040

## 7.6.12.6 Animation functions

Animations can be used to inject some life into the application. They will always help to let the user's eye smoothly capture what happens. All animation functions require 32-bit devices.

### 7.6.12.6.1 GUI\_MEMDEV\_FadeInDevices()

#### Description

Performs fading in one device over another Memory Device.

#### Prototype

```
int GUI_MEMDEV_FadeInDevices(GUI_MEMDEV_Handle hMem0,
                             GUI_MEMDEV_Handle hMem1,
                             int Period);
```

#### Parameters

Parameter	Description
<code>hMem0</code>	Handle of background Memory Device.
<code>hMem1</code>	Handle of Memory Device to be faded in.
<code>Period</code>	Time period in which the fading is processed.

#### Return value

0 if successful.  
1 if the function fails.

#### Additional information

This function requires `hMem0` and `hMem1` to be of the same size and to be located at the same position on the screen.

#### Example

An example application using fading functions can be found in the file `MEMDEV_FadingPerformance.c` which is located in the folder `Sample\Tutorial`.

#### Screenshots

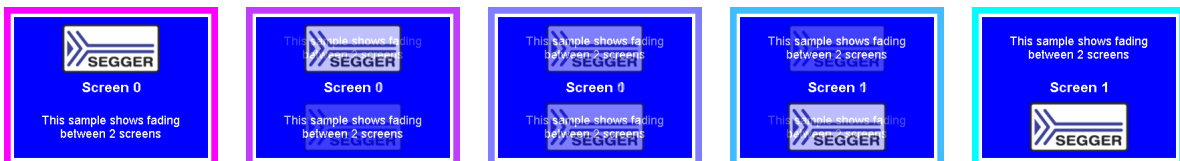

### 7.6.12.6.2 GUI\_MEMDEV\_FadeOutDevices()

#### Description

Performs fading out one device overlaying another Memory Device.

#### Prototype

```
int GUI_MEMDEV_FadeOutDevices(GUI_MEMDEV_Handle hMem0,  
                              GUI_MEMDEV_Handle hMem1,  
                              int Period);
```

#### Parameters

Parameter	Description
<a href="#">hMem0</a>	Handle of background Memory Device.
<a href="#">hMem1</a>	Handle of Memory Device to be faded out.
<a href="#">Period</a>	Time period in which the fading is processed.

#### Return value

0 if successful.  
1 if the function fails.

#### Additional information

This function requires [hMem0](#) and [hMem1](#) to be of the same size and to be located at the same position on the screen.

### 7.6.12.6.3 GUI\_MEMDEV\_SetAnimationCallback()

#### Description

Sets a user defined callback function to be called while animations are processed. The function should contain code to determine whether processing of the current animation shall go on or abort.

#### Prototype

```
void GUI_MEMDEV_SetAnimationCallback(GUI_ANIMATION_CALLBACK_FUNC * pCbAnimation,
                                     void * pVoid);
```

#### Parameters

Parameter	Description
<code>pCbAnimation</code>	Pointer to the user defined callback function.
<code>pVoid</code>	Data pointer.

#### Additional information

The callback function is called every time an animation function has just copied the actual step to the screen.

#### Example

The following example shows the use of a `GUI_ANIMATION_CALLBACK_FUNC`, which gives the possibility to react on PID events:

```
static int _cbAnimation(int TimeRem, void * pVoid) {
    int Pressed;
    if (TimeRem /* Insert Condition */) {
        /* ... React on remaining Time ... */
    }
    Pressed = _GetButtonState();
    if (Pressed) {
        return 1; // Button was pressed, stop animation
    } else {
        return 0; // Button was not pressed, continue animation
    }
}

void main(void) {
    GUI_Init();
    GUI_MEMDEV_SetAnimationCallback(_cbAnimation, (void *)&_Pressed);
    while (1) {
        /* Do animations... */
    }
}
```

#### 7.6.12.6.4 GUI\_MEMDEV\_SetTimePerFrame()

##### Description

Sets the minimum time used for one animation frame. If the process of drawing requires less time `GUI_X_Delay()` is called with the time difference.

##### Prototype

```
void GUI_MEMDEV_SetTimePerFrame(unsigned TimePerFrame);
```

##### Parameters

Parameter	Description
<code>TimePerFrame</code>	Minimum time used for one animation frame.



## 7.6.12.7 Animation functions (Window Manager required)

The following animation functions require usage of the Window Manager.

### 7.6.12.7.1 GUI\_MEMDEV\_FadeInWindow()

### 7.6.12.7.2 GUI\_MEMDEV\_FadeOutWindow()

#### Description

Fades in/out a window by decreasing/increasing the alpha value.

#### Prototypes

```
int GUI_MEMDEV_FadeInWindow (WM_HWIN hWin,
                             int      Period);
```

```
int GUI_MEMDEV_FadeOutWindow(WM_HWIN hWin,
                             int      Period);
```

#### Parameters

Parameter	Description
<code>hWin</code>	Handle to the window which has to be faded out.
<code>Period</code>	Time period in which the fading is processed.

#### Return value

0 if successful.  
1 if the function fails.

#### Additional information

After the window has been faded the desktop and its child windows are validated.

#### Example

An example application using the fading functions for windows can be found in the file `SKINNING_NestedModal.c` which is located in the folder `Sample\Tutorial`.

#### Screenshots



### 7.6.12.7.3 GUI\_MEMDEV\_MoveInWindow()

### 7.6.12.7.4 GUI\_MEMDEV\_MoveOutWindow()

#### Description

Moves a window into/out of the screen. First the window is drawn minimized/maximized at the specified position/its actual position and then moved to its actual position/the specified position while magnifying to its actual size/demagnifying. The window can be spun clockwise as well as counterclockwise while it is moving.

#### Prototypes

```
int GUI_MEMDEV_MoveInWindow (WM_HWIN hWin,
                             int      x,
                             int      y,
                             int      a180,
                             int      Period);

int GUI_MEMDEV_MoveOutWindow(WM_HWIN hWin,
                             int      x,
                             int      y,
                             int      a180,
                             int      Period);
```

#### Parameters

Parameter	Description
<code>hWin</code>	Handle to the window which has to be moved
<code>x</code>	Position in <code>x</code> from/to where the window is moved
<code>y</code>	Position in <code>y</code> from/to where the window is moved
<code>a180</code>	Count of degrees the window will be spun for: <code>a180 = 0</code> -> no spinning <code>a180 &gt; 0</code> -> clockwise <code>a180 &lt; 0</code> -> counterclockwise
<code>Period</code>	Time period in which the moving is processed

#### Return value

0        if successful.  
1        if the function fails.

#### Additional information

First the window is drawn maximized at its actual position and then moved to the specified position while demagnifying. The window can be spun clockwise as well as counterclockwise while it is moving. After the window has been moved the desktop and its child windows are validated. `GUI_MEMDEV_MoveOutWindow()` requires approximately 1 MB of dynamic memory to run properly in QVGA mode.

#### Example

An example application using the functions `GUI_MEMDEV_MoveInWindow()` and `GUI_MEMDEV_MoveOutWindow()` can be found in the file `SKINNING_NestedModal.c` which is located in the folder `Sample\Tutorial` folder.

### Screenshots

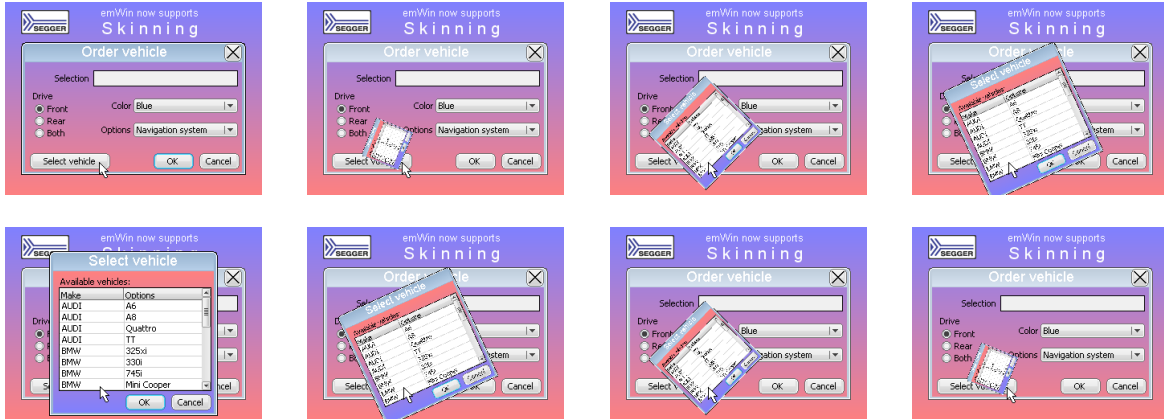

### 7.6.12.7.5 GUI\_MEMDEV\_ShiftInWindow()

### 7.6.12.7.6 GUI\_MEMDEV\_ShiftOutWindow()

#### Description

Shifts a Window in a specified direction into/out of the screen to/from its actual position.

#### Prototypes

```
int GUI_MEMDEV_ShiftInWindow (WM_HWIN hWin,
                              int      Period,
                              int      Direction);

int GUI_MEMDEV_ShiftOutWindow(WM_HWIN hWin,
                              int      Period,
                              int      Direction);
```

#### Parameters

Parameter	Description
<code>hWin</code>	Handle to the window which has to be shifted.
<code>Period</code>	Time period in which the shifting is processed.
<code>Edge</code>	See permitted values under <i>Direction symbols</i> on page 3015.

#### Return value

0        if successful.  
1        if the function fails.

#### Additional information

After the window has been shifted the desktop and its child windows are validated. `GUI_MEMDEV_ShiftOutWindow()` requires approximately 1 MB of dynamic memory to run properly in QVGA mode.

#### Example

An example application using the functions `GUI_MEMDEV_ShiftInWindow()` and `GUI_MEMDEV_ShiftOutWindow()` can be found in the file `SKINNING_Notepad.c` which is located in the folder `Sample\Tutorial` folder.

#### Screenshots

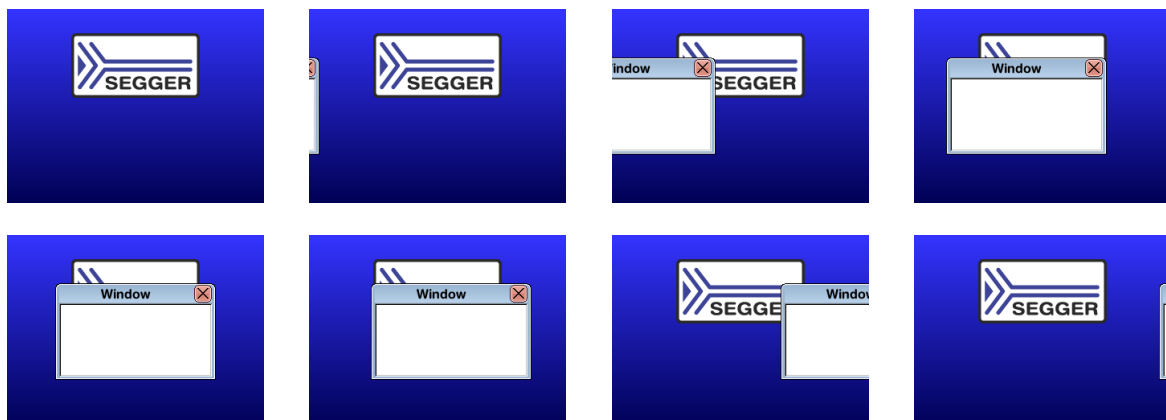

### 7.6.12.7.7 GUI\_MEMDEV\_SwapWindow()

#### Description

Swaps a window with the old content of the target area.

#### Prototype

```
int GUI_MEMDEV_SwapWindow(WM_HWIN hWin,
                          int      Period,
                          int      Edge);
```

#### Parameters

Parameter	Description
<code>hWin</code>	Handle to the window which has to be swapped.
<code>Period</code>	Time period in which the shifting is processed.
<code>Edge</code>	See permitted values under <i>Direction symbols</i> on page 3015.

#### Return value

- 0 if successful.
- 1 if the function fails.

#### Additional information

After the window has been swapped the desktop and its child windows are validated. GUI\_MEMDEV\_SwapWindow() requires approximately 1 MB of dynamic memory to run properly in QVGA mode.

#### Screenshots

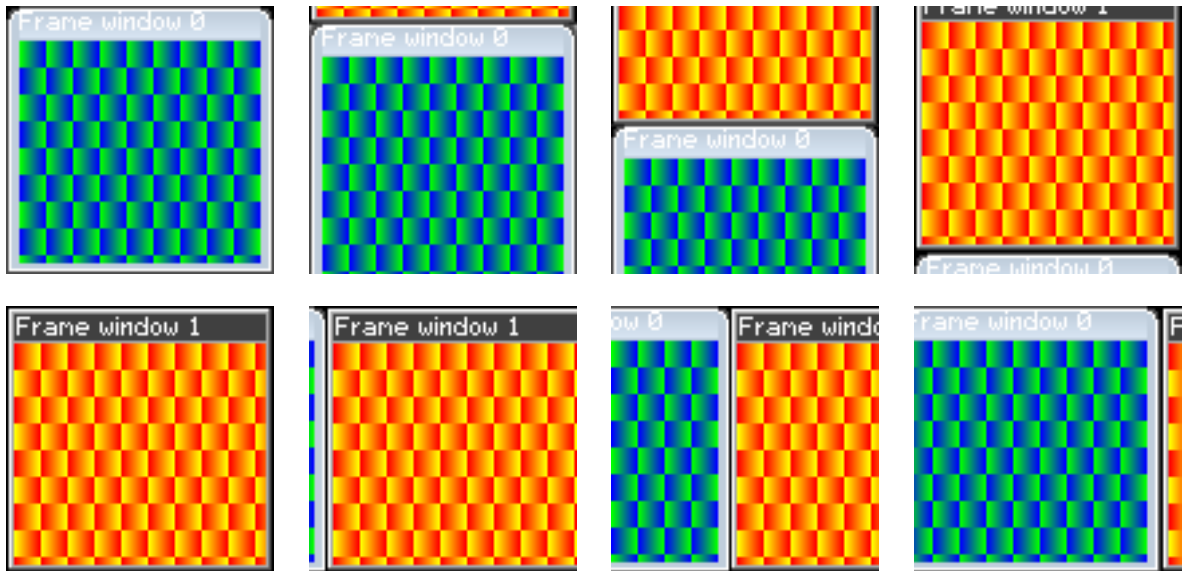

## 7.6.12.8 Blending, Blurring and Dithering functions

### 7.6.12.8.1 GUI\_MEMDEV\_BlendColor32()

#### Description

Blends a window with the given color and blending intensity.

#### Prototype

```
int GUI_MEMDEV_BlendColor32(GUI_MEMDEV_Handle hMem,  
                             U32 BlendColor,  
                             U8 BlendIntens);
```

#### Parameters

Parameter	Description
<a href="#">hMem</a>	Handle to the Memory Device which has to be blended.
<a href="#">BlendColor</a>	Color which is used for the blending effect.
<a href="#">BlendIntens</a>	Intensity of the blending effect. Should be 0 (no blending) - 255 (full blending).

#### Return value

0 on success  
1 on error.

### 7.6.12.8.2 GUI\_MEMDEV\_CreateBlurredDevice32()

#### Description

Creates a blurred copy of the given Memory Device using the currently set blurring function.

#### Prototype

```
GUI_MEMDEV_Handle GUI_MEMDEV_CreateBlurredDevice32(GUI_MEMDEV_Handle hMemSrc,
                                                    U8 Depth);
```

#### Parameters

Parameter	Description
hMem	Handle to the Memory Device which has to be blurred.
Depth	Depth of the blurring effect. Should be specified with 1-10.

#### Return value

Handle of the blurred Memory Device.

#### Additional information

The source Memory Device should consist of a color depth of 32 bpp. The resulting Memory Device will be of the same size at 32 bpp. Information about memory usage and performance can be found in the descriptions of the ...HQ() and ...LQ()-function. This function works according to the currently set blurring quality. In order to change the quality, the functions GUI\_MEMDEV\_SetBlurHQ() and GUI\_MEMDEV\_SetBlurLQ() can be used. The default quality is high.

#### Comparison

This screenshot shows the same elements without effect in the top row, blurred at high quality in the left column and blurred at low quality in the right column. The blurring depth was set as follows:

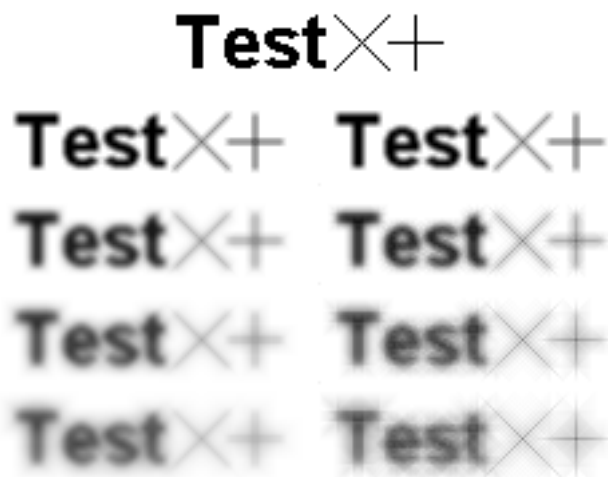

Row number	Blurring depth
1st row	0
2nd row	1
3rd row	3
4th row	5
5th row	7

## Performance

The performance is given relative to the time it takes to create a blurred device at high quality using a blurring depth of 1.

Blurring depth	High Quality	Low Quality
1	1	1.32
3	3.54	2.01
5	8.65	2.65
7	16.16	3.26

According to the values creating a blurred device at high quality using a blurring depth of 5 takes approximately half the time it would take to create a blurred device at high quality using a blurring depth of 7.



### 7.6.12.8.3 GUI\_MEMDEV\_CreateBlurredDevice32HQ()

#### Description

Creates a blurred copy of the given Memory Device at high quality.

#### Prototype

```
GUI_MEMDEV_Handle GUI_MEMDEV_CreateBlurredDevice32HQ(GUI_MEMDEV_Handle hMemSrc,
                                                    U8 Depth);
```

#### Parameters

Parameter	Description
<a href="#">hMem</a>	Handle to the Memory Device which has to be blurred.
<a href="#">Depth</a>	<a href="#">Depth</a> of the blurring effect. Should be specified with 1-10.

#### Return value

Handle of the blurred Memory Device. 0, if the function fails.

#### Additional information

The source Memory Device should consist of a color depth of 32 bpp. The resulting Memory Device will be of the same size at 32 bpp. This routine requires an addition of 16 bytes per pixel plus memory to allocate iterator arrays which are used to accelerate pixel addressing. The required memory for the iterator arrays depends on the blurring depth to perform. The number of bytes is calculated as follows:

```
Size = (1 + Depth * (Depth - 1) * 4) * (3 * sizeof(int) + 4)
```

A screenshot can be found under *GUI\_MEMDEV\_CreateBlurredDevice32* on page 2991.

#### 7.6.12.8.4 GUI\_MEMDEV\_CreateBlurredDevice32LQ()

##### Description

Creates a blurred copy of the given Memory Device at low quality.

##### Prototype

```
GUI_MEMDEV_Handle GUI_MEMDEV_CreateBlurredDevice32LQ(GUI_MEMDEV_Handle hMemSrc,  
                                                    U8 Depth);
```

##### Parameters

Parameter	Description
<a href="#">hMem</a>	Handle to the Memory Device which has to be blurred.
<a href="#">Depth</a>	<a href="#">Depth</a> of the blurring effect. Should be specified with 1-10.

##### Return value

Handle of the blurred Memory Device. 0, if the function fails.

##### Additional information

The source Memory Device should consist of a color depth of 32 bpp. This is a creating function. The created Memory Device will be of the same size at 32 bpp. Beyond that no additional memory is required. A screenshot can be found under `GUI_MEMDEV_CreateBlurredDevice32()`.

### 7.6.12.8.5 GUI\_MEMDEV\_Dither32()

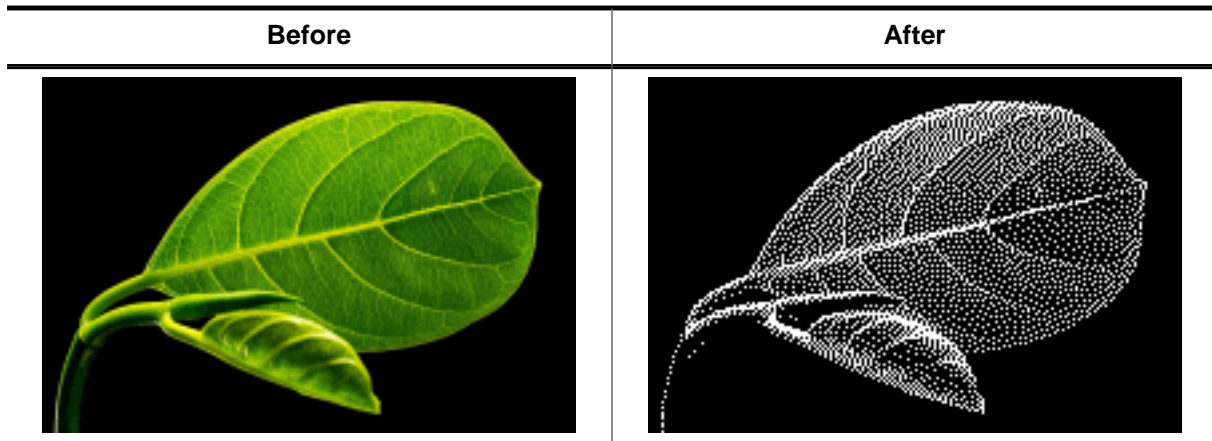

#### Description

The function dithers the given memory device using the given fixed palette mode. Please note that the function does not reduce the color depth of the memory device. If dithered images with a reduced color depth (and less storage requirement) are desired, the bitmap converter should be used to dither the images.

#### Prototype

```
int GUI_MEMDEV_Dither32(      GUI_MEMDEV_Handle  hMem,
                             const LCD_API_COLOR_CONV * pColorConvAPI);
```

#### Parameters

Parameter	Description
<code>hMem</code>	Handle to the Memory Device which has to be dithered.
<code>pColorConvAPI</code>	Color conversion to be used.

#### Return value

0        on success  
1        on error.

#### Additional information

The function works only with memory devices having a color depth of 32bpp.

### 7.6.12.8.6 GUI\_MEMDEV\_SetBlurHQ()

#### Description

Sets the blurring quality to high.

#### Prototype

```
void GUI_MEMDEV_SetBlurHQ(void);
```

#### Additional information

Setting the blurring quality affects the function `GUI_MEMDEV_CreateBlurredDevice32()` which in turn is called by other functions. (e.g. `GUI_MEMDEV_BlurWinBk()`).

### 7.6.12.8.7 GUI\_MEMDEV\_SetBlurLQ()

#### Description

Sets the blurring quality to low.

#### Prototype

```
void GUI_MEMDEV_SetBlurLQ(void);
```

#### Additional information

Additional information is stated under "GUI\_MEMDEV\_SetBlurHQ()".

## 7.6.12.9 Blending and Blurring functions (Window Manager required)

### 7.6.12.9.1 GUI\_MEMDEV\_BlendWinBk()

#### Description

Blends the background of a window within the given period from its initial state to the given blending intensity.

#### Prototype

```
int GUI_MEMDEV_BlendWinBk(WM_HWIN hWin,
                          int      Period,
                          U32      BlendColor,
                          U8       BlendIntens);
```

#### Parameters

Parameter	Description
<code>hWin</code>	Handle to the window which has to be blended.
<code>Period</code>	Effect <code>Period</code> .
<code>BlendColor</code>	Color which is used for the background to be blended with.
<code>BlendIntens</code>	Final intensity of the blending effect. Should be 0 (no blending) - 255 (full blending).

#### Return value

0        on success  
1        on error.

#### Screenshots

The following screenshots show the background window being blended in 5 steps. The blending is performed using `GUI_BLACK` as `BlendColor`. `BlendIntens` is given with the highest possible value of 255.

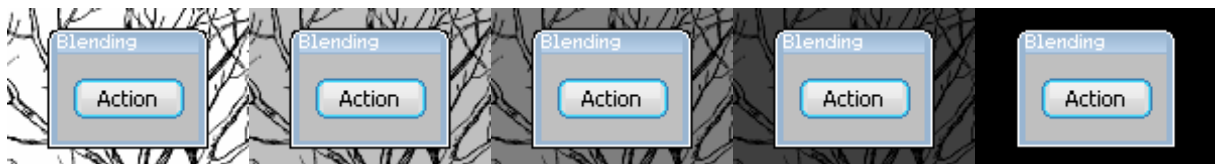

### 7.6.12.9.2 GUI\_MEMDEV\_BlurAndBlendWinBk()

#### Description

Blurs and blends the background of a window within the given period from its initial state to the given blurring value and blending intensity.

#### Prototype

```
int GUI_MEMDEV_BlurAndBlendWinBk(WM_HWIN hWin,
                                   int      Period,
                                   U8      BlurDepth,
                                   U32     BlendColor,
                                   U8      BlendIntens);
```

#### Parameters

Parameter	Description
<code>hWin</code>	Handle to the window which has to be blurred.
<code>Period</code>	Effect <code>Period</code> .
<code>BlurDepth</code>	Final depth of the blurring effect. Should be specified with 1-10.
<code>BlendColor</code>	Color which is used for the background to be blended with.
<code>BlendIntens</code>	Final intensity of the blending effect. Should be 0 (no blending) - 255 (full blending).

#### Return value

0        on success  
1        on error.

#### Additional information

The blurring quality can be changed using the functions `GUI_MEMDEV_SetBlurHQ()` or `GUI_MEMDEV_SetBlurLQ()`.

#### Screenshots

The following screenshots show the background window being blurred and blended in 5 steps. The used values are 10 as blurring depth and 64 as blending intensity. The blending color is `GUI_WHITE`.

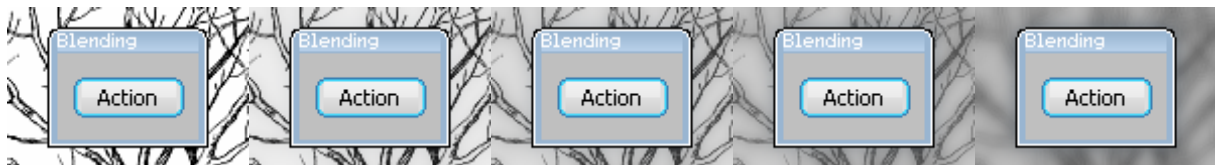

### 7.6.12.9.3 GUI\_MEMDEV\_BlurWinBk()

#### Description

Blurs the background of a window within the given period from its initial state to the given blurring value.

#### Prototype

```
int GUI_MEMDEV_BlurWinBk(WM_HWIN hWin,
                          int      Period,
                          U8       BlurDepth);
```

#### Parameters

Parameter	Description
<code>hWin</code>	Handle to the window whose background has to be blurred.
<code>Period</code>	Effect <code>Period</code> .
<code>BlurDepth</code>	Final depth of the blurring effect. Should be specified with 1-10.

#### Return value

0        on success  
1        on error.

#### Additional information

The blurring quality can be changed using the functions `GUI_MEMDEV_SetBlurHQ()` or `GUI_MEMDEV_SetBlurLQ()`.

#### Screenshots

The following screenshots show the background window being blurred in 5 steps. The used blurring depth is 10.

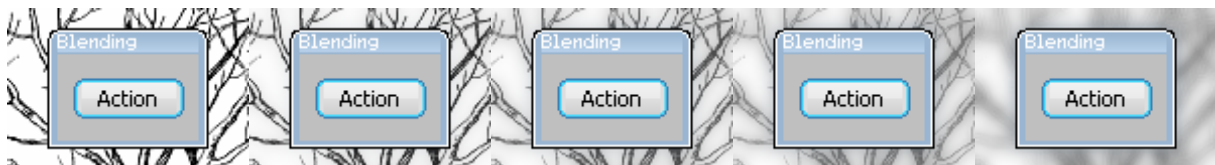



## 7.6.12.10 Setting up multiple buffering for animation functions

'Animation functions' refers to all functions listed in chapters

- *Animation functions* on page 2981
- *Animation functions (Window Manager required)* on page 2985
- *Blending, Blurring and Dithering functions* on page 2990
- *Blending and Blurring functions (Window Manager required)* on page 2998

### 7.6.12.10.1 GUI\_MEMDEV\_MULTIBUF\_Enable()

#### Description

Normally memory device animation functions do not use multiple buffers. But under certain circumstances it could make sense to enable multiple buffers here. If enabled, the animation functions use `GUI_MULTIBUF_Begin()` and `GUI_MULTIBUF_End()` before/after drawing the memory device on the display.

#### Prototype

```
int GUI_MEMDEV_MULTIBUF_Enable(int OnOff);
```

#### Parameters

Parameter	Description
<code>OnOff</code>	Use 1 for enabling, 0 for disabling use of multiple buffers.

#### Return value

Previous state.

#### Additional information

Normally memory device animation functions do not use multiple buffers. But under certain circumstances it could make sense to enable multiple buffers here. If enabled, the animation functions use `GUI_MULTIBUF_Begin()` and `GUI_MULTIBUF_End()` before/after drawing the memory device on the display. That function makes sense in connection with '`GUI_D-CACHE_SetClearCacheHook()`'.

### 7.6.12.11 Memory bitmaps

Memory Bitmaps are images pre-rendered in RAM. Any image format supported by emWin can be pre-rendered. The created memory bitmaps can be used with any API call expecting a bitmap as parameter.

In general it is much faster to render bitmaps instead of common image formats since decoding and formatting is performed once rather than each time an image is displayed. Performance is increased further if these bitmaps are located in fast RAM. Using memory bitmaps increases the performance and responsiveness of a GUI.

Memory bitmaps are intended to be created once on startup. It is not possible to alter a memory bitmap once created. In order to change the content of a memory bitmap, simply delete it and create it anew.

The disadvantage is an increased requirement for RAM which can be in the order of megabytes, depending on the size, color depth, and number of memory bitmaps created.

Currently only 16 and 32 bit per pixel memory bitmaps are supported.

#### Memory requirement

The memory required for a bitmap is calculated as shown below:

```
Color depth * XSIZE * YSIZE + Sizeof memory bitmap struct
```

For a 32 bpp Bitmap and a size of 100 pixels in each direction this results in:

```
4 * 100 * 100 + 28 = 40.028 bytes
```

#### Example

The following example shows how to create a memory bitmap from a PNG and use it with an IMAGE widget.

```
#include "DIALOG.h"

void MainTask(void) {
    WM_HWIN      hImage;
    GUI_MBITMAP * pMBitmap;

    GUI_Init();
    pMBitmap = GUI_MBITMAP_Create(GUI_MBITMAP_PNG,
                                  (const void *)_acMyPng,
                                  sizeof(_acMyPng));

    hImage = IMAGE_CreateEx(10,
                            10,
                            GUI_MBITMAP_2BITMAP(pMBitmap)->XSize,
                            GUI_MBITMAP_2BITMAP(pMBitmap)->YSize,
                            WM_HBKWIN,
                            WM_CF_SHOW,
                            0,
                            GUI_ID_IMAGE0);

    IMAGE_SetBitmap(hImage, GUI_MBITMAP_2BITMAP(pMBitmap));
    while (1) {
        GUI_Delay(100);
    }
}
```

### 7.6.12.11.1 Predefined drawing functions

#### Description

The following table shows predefined drawing functions which can be used to create a memory bitmap.

#### Symbols

Definition	Description
<a href="#">GUI_MBITMAP_BITMAP</a>	Create a bitmap from a bitmap, e.g. decompress an RLE compressed bitmap.
<a href="#">GUI_MBITMAP_BMP</a>	Create a bitmap from a BMP file located directly-addressable memory.
<a href="#">GUI_MBITMAP_DTA</a>	Create a bitmap from a DTA file located directly-addressable memory.
<a href="#">GUI_MBITMAP_GIF</a>	Create a bitmap from a GIF file located directly-addressable memory.
<a href="#">GUI_MBITMAP_JPEG</a>	Create a bitmap from a JPEG file located directly-addressable memory.
<a href="#">GUI_MBITMAP_PNG</a>	Create a bitmap from a PNG file located directly-addressable memory.
<a href="#">GUI_MBITMAP_SVG</a>	Create a bitmap from a SVG file located directly-addressable memory.
<a href="#">GUI_MBITMAP_BMP_EX</a>	Create a bitmap from a BMP file located in external storage.
<a href="#">GUI_MBITMAP_DTA_EX</a>	Create a bitmap from a DTA file located in external storage.
<a href="#">GUI_MBITMAP_GIF_EX</a>	Create a bitmap from a GIF file located in external storage.
<a href="#">GUI_MBITMAP_JPEG_EX</a>	Create a bitmap from a JPEG file located in external storage.
<a href="#">GUI_MBITMAP_PNG_EX</a>	Create a bitmap from a PNG file located in external storage.
<a href="#">GUI_MBITMAP_SVG_EX</a>	Create a bitmap from a SVG file located in external storage.

## 7.6.12.11.2 User defined drawing function

### Description

Instead of using predefined drawing functions the user can also define a custom drawing function. This drawing function defines how emWin creates the content of a memory bitmap. There are two different prototypes. One to be used with `GUI_MBITMAP_Create()` and one for `GUI_MBITMAP_CreateEx()`.

### Prototype

```
typedef int GUI_MBITMAP_DRAW_IMAGE (const void * p,
                                     int Size,
                                     GUI_MBITMAP_PARAM * pPara);

typedef int GUI_MBITMAP_DRAW_IMAGE_EX(GUI_GET_DATA_FUNC * pfGetData,
                                       void * p,
                                       GUI_MBITMAP_PARAM * pPara);
```

### Structure members

GUI_MBITMAP_DRAW_IMAGE	
<code>p</code>	Pointer to the image data.
<code>Size</code>	The size of the image data.
<code>pPara</code>	Pointer to <code>GUI_MBITMAP_PARAM</code> .
GUI_MBITMAP_DRAW_IMAGE_EX	
<code>pfGetData</code>	Function pointer to GetData function
<code>p</code>	Function pointer to delete a memory device
<code>pPara</code>	Pointer to <code>GUI_MBITMAP_PARAM</code> .

### Additional information

The member `Cmd` of `GUI_MBITMAP_PARAM` is used to signal which operation should be performed next. When receiving the commands `GUI_MBITMAP_CMD_XSIZE` and `GUI_MBITMAP_CMD_YSIZE` the drawing function has to return the dimensions of the bitmap to be created. This can be either the actual size of an image or any other size preferred by the user.

The command `GUI_MBITMAP_CMD_DRAW` signals that the bitmap content has to be drawn. Typically this is an image but can also be any other kind of drawing operation.

For a detailed description of `GUI_MBITMAP_PARAM` please refer to `GUI_MBITMAP_PARAM` on page 3006.

### Example

The following example shows how to use a custom drawing function. In the example a red X is placed on top of a PNG drawn into a memory bitmap.

```
static int _DrawImage(const void * p, int Size, GUI_MBITMAP_PARAM * pPara) {
    switch (pPara->Cmd) {
        case GUI_MBITMAP_CMD_XSIZE:
            return GUI_PNG_GetXSize(p, Size);
        case GUI_MBITMAP_CMD_YSIZE:
            return GUI_PNG_GetYSize(p, Size);
        case GUI_MBITMAP_CMD_DRAW:
            GUI_SetBkColor(GUI_TRANSPARENT);
            GUI_Clear();
            GUI_PNG_Draw(p, Size, 0, 0);
            GUI_SetColor(GUI_RED);
            GUI_SetPenSize(4);
            GUI_DrawLine(0, 0, pPara->xSize - 1, pPara->ySize - 1);
```

```
    GUI_DrawLine(0, pPara->ySize - 1, pPara->xSize - 1, 0);  
    return 0;  
}  
return 0;  
}  
  
GUI_MBITMAP_CreateUser(_DrawImage,  
                        (const void *)_acPNG_50x50,  
                        sizeof(_acPNG_50x50),  
                        50,  
                        50,  
                        NULL);
```

### 7.6.12.11.3 GUI\_MBITMAP\_PARAM

#### Description

A drawing function receives a pointer to a GUI\_MBITMAP\_PARAM structure. This structure is used to pass a command, the bitmap dimensions and a pointer to extra data to the drawing function.

```
typedef struct {
    U8    Cmd;
    int   xSize;
    int   ySize;
    void * pExtra;
} GUI_MBITMAP_PARAM;
```

#### Structure members

Member	Description
Cmd	Command passed to the drawing function
xSize	xSize of the bitmap to be generated
ySize	ySize of the bitmap to be generated
pExtra	Pointer to extra data.

#### Values of Cmd

Symbol	Description
GUI_MBITMAP_CMD_XSIZE	Requesting the x size if the bitmap.
GUI_MBITMAP_CMD_YSIZE	Requesting the y size if the bitmap.
GUI_MBITMAP_CMD_DRAW	Draw the actual bitmap.

#### Additional information

pExtra can be used to pass a pointer to extra data to a custom drawing function.

### 7.6.12.11.4 GUI\_MBITMAP\_CONFIG

#### Description

A pointer to a GUI\_MBITMAP\_CONFIG structure can be passed to the functions GUI\_MBITMAP\_CreateUser() and GUI\_MBITMAP\_CreateUserEx() to set custom functions for creating and deleting memory devices. Additionally a pointer to extra data can be set.

```
typedef struct {
    GUI_MBITMAP_CREATE_MEMDEV * pfCreateMemdev;
    GUI_MBITMAP_DELETE_MEMDEV * pfDeleteMemdev;
    void * pExtra;
} GUI_MBITMAP_CONFIG;
```

#### Structure members

Member	Description
pfCreateMemdev	Function pointer to create a memory device
pfDeleteMemdev	Function pointer to delete a memory device
pExtra	Pointer to extra data.

#### Prototypes for pfCreateMemdev and pfDeleteMemdev

```
typedef GUI_MEMDEV_Handle GUI_MBITMAP_CREATE_MEMDEV(int xSize,
int ySize,
void * pExtra);

typedef GUI_MEMDEV_Handle GUI_MBITMAP_DELETE_MEMDEV(GUI_MEMDEV_Handle hMem,
void * pExtra);
```

#### Additional information

The function pointers allowing the user to set custom functions for creating and deleting memory devices.

For creating a memory device only the following color formats are supported.

Definition	Description
GUICC_555	Fixed palette mode 555.
GUICC_M555	Fixed palette mode M555.
GUICC_565	Fixed palette mode 565.
GUICC_M565	Fixed palette mode M565.
GUICC_888	Fixed palette mode 888.
GUICC_M888	Fixed palette mode M888.
GUICC_8888	Fixed palette mode 8888.
GUICC_M8888I	Fixed palette mode M8888I.

### 7.6.12.11.5 GUI\_MBITMAP\_Create()

#### Description

This function creates a memory bitmap by using resources located directly accessible memory.

#### Prototype

```
GUI_MBITMAP *GUI_MBITMAP_Create(      GUI_MBITMAP_DRAW_IMAGE * pFuncDraw,  
                                   const void * pData,  
                                   int      SizeOfData);
```

#### Parameters

Parameter	Description
<a href="#">pFuncDraw</a>	Pointer to a drawing function.
<a href="#">pData</a>	Function pointer to a get data function.
<a href="#">SizeOfData</a>	Pointer to the data.

#### Return value

A pointer to a memory bitmap.

#### Additional information

For further information and a more detailed create function refer to `GUI_MBITMAP_CreateUser()`.



### 7.6.12.11.6 GUI\_MBITMAP\_CreateEx()

#### Description

This function creates a memory bitmap by using resources located external memory.

#### Prototype

```
GUI_MBITMAP *GUI_MBITMAP_CreateEx(GUI_MBITMAP_DRAW_IMAGE_EX * pFuncDrawEx,
                                  GUI_GET_DATA_FUNC          * pfGetData,
                                  void                        * p);
```

#### Parameters

Parameter	Description
<code>pFuncDrawEx</code>	<b>in</b> Pointer to a drawing function.
<code>pfGetData</code>	<b>in</b> Function pointer to a GetData function. For more details, please refer to the chapter <i>FileAccess</i> on page 3219.
<code>p</code>	<b>in</b> Pointer to the data.

#### Return value

A pointer to a memory bitmap.

#### Additional information

For further information and a more detailed create function refer to `GUI_MBITMAP_CreateUserEx()`.

### 7.6.12.11.7 GUI\_MBITMAP\_CreateUser()

#### Description

This function creates a memory bitmap by using resources located directly accessible memory.

#### Prototype

```
GUI_MBITMAP *GUI_MBITMAP_CreateUser(      GUI_MBITMAP_DRAW_IMAGE * pFuncDraw,
                                         const void          * pData,
                                         int                SizeOfData,
                                         int                xSize,
                                         int                ySize,
                                         GUI_MBITMAP_CONFIG * pConfig);
```

#### Parameters

Parameter	Description
<a href="#">pFuncDraw</a>	Pointer to a drawing function.
<a href="#">pData</a>	Pointer to the image.
<a href="#">SizeOfData</a>	Size of the image in bytes.
<a href="#">xSize</a>	x size of the bitmap to be created.
<a href="#">ySize</a>	y size of the bitmap to be created.
<a href="#">pConfig</a>	Pointer to a configuration structure.

#### Return value

A pointer to a memory bitmap.

#### Additional information

This function is used when `GUI_MBITMAP_Create()` is not detailed enough. It also allows the user to attach user data in the last parameter. This user data can be accessed in a custom drawing function. Predefined values for [pFuncDraw](#) can be found under `GUI_MBITMAP_PARAM` on page 3006.

### 7.6.12.11.8 GUI\_MBITMAP\_CreateUserEx()

#### Description

This function creates a memory bitmap by using resources located external memory.

#### Prototype

```

GUI_MBITMAP *GUI_MBITMAP_CreateUserEx(GUI_MBITMAP_DRAW_IMAGE_EX * pFuncDrawEx,
                                       GUI_GET_DATA_FUNC          * pfGetData,
                                       void                       * p,
                                       int                        xSize,
                                       int                        ySize,
                                       GUI_MBITMAP_CONFIG        * pConfig);

```

#### Parameters

Parameter	Description
<code>pFuncDrawEx</code>	<b>in</b> Pointer to a drawing function.
<code>pfGetData</code>	<b>in</b> Function pointer to a GetData function. For more details, please refer to the chapter <i>FileAccess</i> on page 3219.
<code>p</code>	<b>in</b> Pointer to the data.
<code>xSize</code>	x size of the bitmap to be created.
<code>ySize</code>	y size of the bitmap to be created.
<code>pConfig</code>	<b>in</b> Pointer to a configuration structure.

#### Return value

A pointer to a memory bitmap.

#### Additional information

This function is used when `GUI_MBITMAP_CreateEx()` is not detailed enough. It also allows the user to attach user data in the last parameter. This user data can be accessed in a custom drawing function. Which type of GetData function has to be used is defined by the type of image to be drawn. For details please refer to *Getting data with the ...Ex() functions* on page .

### 7.6.12.11.9 GUI\_MBITMAP\_Delete()

#### Description

This function deletes the given memory bitmap.

#### Prototype

```
void GUI_MBITMAP_Delete(GUI_MBITMAP * pMBitmap);
```

#### Parameters

Parameter	Description
<a href="#">pMBitmap</a>	Pointer to memory bitmap.

### 7.6.12.11.10 GUI\_MBITMAP\_SetColorFormat()

#### Description

This function sets the color depth to be used.

#### Prototype

```
void GUI_MBITMAP_SetColorFormat(const GUI_DEVICE_API * pDeviceAPI,  
                               const LCD_API_COLOR_CONV * pColorConvAPI);
```

#### Parameters

Parameter	Description
<code>pDeviceAPI</code>	API list used to create temporary memory device.
<code>pColorConvAPI</code>	Color conversion used to create temporary memory device.

#### Additional information

The default is auto mode. In this mode the created bitmaps will use either 16 or 32 bpp depending on the display driver configuration. Pass `NULL` as parameter to return to default.

## 7.6.12.12 Defines

### 7.6.12.12.1 Color conversion routines

#### Description

This parameter defines the desired color conversion. For more details about the used bits per pixel and the color conversion, refer to the chapter *Colors* on page 604.

#### Definition

```
#define GUICC_1          &LCD_API_ColorConv_1
#define GUICC_2          &LCD_API_ColorConv_2
#define GUICC_4          &LCD_API_ColorConv_4
#define GUICC_565       &LCD_API_ColorConv_565
#define GUICC_M565      &LCD_API_ColorConv_M565
#define GUICC_8666      &LCD_API_ColorConv_8666
#define GUICC_888       &LCD_API_ColorConv_888
#define GUICC_8888      &LCD_API_ColorConv_8888
```

#### Symbols

Definition	Description
GUICC_1	Fixed palette mode 1. (black/white)
GUICC_2	Fixed palette mode 2. (4 gray scales)
GUICC_4	Fixed palette mode 4. (16 gray scales)
GUICC_565	Fixed palette mode 565.
GUICC_M565	Fixed palette mode M565.
GUICC_8666	Fixed palette mode 8666.
GUICC_888	Fixed palette mode 888.
GUICC_8888	Fixed palette mode 8888.
GUICC_M8888I	Fixed palette mode M8888I.

### 7.6.12.12.2 Direction symbols

#### Description

Symbols used by memory device routines to determine in which direction a window should be moved.

#### Definition

```
#define GUI_MEMDEV_EDGE_LEFT      0
#define GUI_MEMDEV_EDGE_RIGHT    1
#define GUI_MEMDEV_EDGE_TOP      2
#define GUI_MEMDEV_EDGE_BOTTOM   3
```

#### Symbols

Definition	Description
<a href="#">GUI_MEMDEV_EDGE_LEFT</a>	Shift window to the left.
<a href="#">GUI_MEMDEV_EDGE_RIGHT</a>	Shift window to the right.
<a href="#">GUI_MEMDEV_EDGE_TOP</a>	Shift window to the top.
<a href="#">GUI_MEMDEV_EDGE_BOTTOM</a>	Shift window to the bottom.

#### See also

- [GUI\\_MEMDEV\\_ShiftInWindow\(\)](#)
- [GUI\\_MEMDEV\\_ShiftOutWindow\(\)](#)
- [GUI\\_MEMDEV\\_SwapWindow\(\)](#)

### 7.6.12.12.3 Memory device color depths

#### Description

Defines the color depth of the Memory Device in bpp. The color depth of the Memory Device should be equal or greater than the required bits for the color conversion routines.

#### Definition

```
#define GUI_MEMDEV_APILIST_1      &GUI_MEMDEV_DEVICE_1
#define GUI_MEMDEV_APILIST_8      &GUI_MEMDEV_DEVICE_8
#define GUI_MEMDEV_APILIST_16     &GUI_MEMDEV_DEVICE_16
#define GUI_MEMDEV_APILIST_32     &GUI_MEMDEV_DEVICE_32
```

#### Symbols

Definition	Description
<a href="#">GUI_MEMDEV_APILIST_1</a>	Create Memory Device with 1bpp color depth (1 byte per 8 pixels). Use if the specified color conversion requires 1bpp.
<a href="#">GUI_MEMDEV_APILIST_8</a>	Create Memory Device with 8bpp color depth (1 byte per pixel). Use if the specified color conversion requires 8bpp or less.
<a href="#">GUI_MEMDEV_APILIST_16</a>	Create Memory Device with 16bpp color depth (1 U16 per pixel). Use if the specified color conversion requires more than 8 bpp (high color modes).
<a href="#">GUI_MEMDEV_APILIST_32</a>	Create Memory Device with 32bpp color depth (1 U32 per pixel). Use if the specified color conversion requires more than 16 bpp (true color modes).

#### Additional information

A Memory Device with a 1bpp color conversion ([GUI\\_COLOR\\_CONV\\_1](#)) for example requires at least a Memory Device with 1bpp color depth. The available Memory Devices are 1bpp, 8bpp, 16bpp and 32bpp Memory Devices. So an 1bpp Memory Device should be used.

If using a 4 bit per pixel color conversion ([GUI\\_COLOR\\_CONV\\_4](#)) at least 4bpp are needed for the Memory Device. In this case an 8bpp Memory Device should be used.



### 7.6.12.12.4 Memory device flags

#### Description

Flags to be used for the creation of a memory device.

#### Definition

```
#define GUI_MEMDEV_HASTRANS    0
#define GUI_MEMDEV_NOTRANS    (1 << 0)
```

#### Symbols

Definition	Description
<a href="#">GUI_MEMDEV_HASTRANS</a>	Default: The Memory Device is created with a transparency flag which ensures that the background will be drawn correctly.
<a href="#">GUI_MEMDEV_NOTRANS</a>	Creates a Memory Device without transparency. The user must make sure that the background is drawn correctly. This way the Memory Device can be used for non-rectangular areas. An other advantage is the higher speed: Using this flag accelerates the Memory Device approx. by 30 - 50%.

## 7.7 MultiTouch support (MT)

Initially the concept of emWin was based on a single touch and keyboard interface. Since smartphones with MultiTouch capabilities became more and more attractive, it was a need to implement MultiTouch capabilities also to emWin. The emWin implementation is able to recognize up to 10 touch points, whereas the maximum number of touch points is limited by the target hardware.

Single touch screens usually consist of resistive touch panels. Most of the MultiTouch panels are capacitive panels which behave different to resistive panels. Whereas a resistive touch panel needs a noticeable pressure, a capacitive panel just requires a smooth touch for recognizing the touch event.

MultiTouch support is an add-on and not part of the emWin basic package. It has to be purchased separately. The emWin Simulation supports the MultiTouch feature, so it is possible to evaluate MultiTouch samples which are provided on [www.segger.com](http://www.segger.com). To do so it is necessary to have a MultiTouch display connected to the computer.

The following chapter shows the implementation of MultiTouch functionality in emWin.

### 7.7.1 Introduction

A MultiTouch panel enables the application to react on multiple touch point inputs simultaneously. The implementation of MT support in emWin offers different consecutive levels of MT access:

- Basic buffer access
- Gesture support (requires the Window Manager)
- Automatic window animation (requires the Window Manager) Gesture support requires basic buffer access, window animation is based on gesture support.

#### Basic buffer access

The MT buffer is able to store a configurable number of MT events. The buffer access API functions consists of functions for storing new events, polling the buffer, setting the touch screen orientation and basically enabling MT support. A detailed description of the available API functions follows later.

#### Gesture support

This level of MT support is responsible for gesture recognition and requires the window manager. If a gesture is detected, a `WM_GESTURE` message with more detailed information is send to the according window. It can be used to modify any kind of data. Detailed descriptions how to use the gesture messages follow later.

#### Window animation

emWin also offers the possibility for automatic window animation via gesture support. Windows can be moved and resized automatically by gesture input. This can be achieved simply by setting the according flags when creating the window. It does not include automatic resizing of fonts and objects shown in the window. This need to be done by the application based on a factor which is passed to/from the application. Details follow later in this chapter.

## 7.7.2 Getting started

Only a few things need to be considered to be able to use MT support. It needs to be enabled, the MT buffer needs to be filled and it must be ensured that the buffer is polled by emWin if gesture support or window animation is required.

### Enabling MT support

To be able to use MT support it needs to be enabled once. It is recommended to do that immediately after the initialization:

```
void MainTask(void) {
    GUI_Init();
    GUI_MTOUCH_Enable(1);
}
```

### Filling the MT buffer

Further it is required to fill the MT buffer with MT events. That can be done either by an existing MT driver like `GUIMTDRV_TangoC32` or by filling the buffer by a custom driver. In case of using a custom driver the function `GUI_MTOUCH_StoreEvent()` needs to be used to do that. The function will be explained later in detail.

### Polling the MT buffer

Once MT support has been enabled, the window manager (WM) automatically polls the MT buffer. That is done when executing an emWin update function (typically `GUI_Exec()`, `GUI_Delay()` or `WM_Exec()`). If no gesture support is required the buffer can also be polled manually by the functions `GUI_MTOUCH_GetEvent()` and `GUI_MTOUCH_GetTouchInput()`. In case of automatic polling by emWin the gesture detecting module will automatically send `WM_GESTURE` messages to the according window.

## 7.7.3 Using basic buffer access

The functions explained later under *Basic buffer access API* on page 3024 can be used for that. Polling works as follows:

### Polling an MT event from the buffer

`GUI_MTOUCH_GetEvent()` should be used to get an existing MT event from the buffer. It passes a pointer to a `GUI_MTOUCH_EVENT` structure to the function to be filled with information like the number of touch points of the current event. If the function fails there is no existing event. Otherwise the `GUI_MTOUCH_EVENT` structure contains the number of touch points associated to the event.

### Getting the touch points of an MT event

`GUI_MTOUCH_GetTouchInput()` should be used for getting the point information for each single touch point. It passes a pointer to a `GUI_MTOUCH_INPUT` structure to the function to be filled by the function. That information comprises position, ID and flags.

### Example 1

The following code shows a very simple function which continuously polls the MT buffer and draws each touch point:

```
#include "GUI.h"
void MainTask(void) {
    GUI_MTOUCH_EVENT Event;
    GUI_MTOUCH_INPUT Input;
    unsigned i;
    GUI_Init();
    GUI_MTOUCH_Enable(1);
    GUI_SetPenSize(5);
    do {
        if (GUI_MTOUCH_GetEvent(&Event) == 0) {
            for (i = 0; i < Event.NumPoints; i++) {
                GUI_MTOUCH_GetTouchInput(&Event, &Input, i);
                GUI_DrawPoint(Input.x, Input.y);
            }
        }
        GUI_Delay(1);
    } while (1);
}
```

### Screenshot of above sample

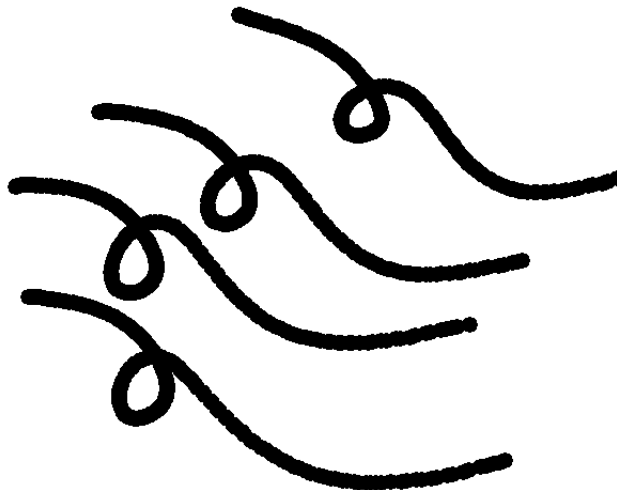

## Example 2

The sample folder of emWin contains the sample `MTOUCH_ScratchAndGestures.c`. It can be used to get more familiar with processing basic buffer access and MT support. It contains a scratchpad sub sample which detects multiple points and uses their IDs for assigning a unique color.

## Screenshot

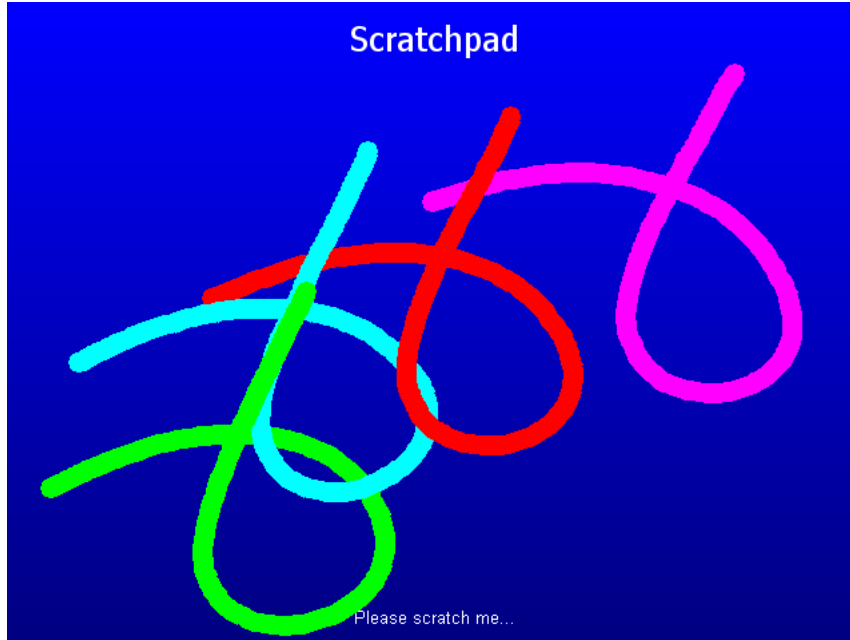

## 7.7.4 Using gestures

Gestures in emWin are based on motion detection via MultiTouch panel. Each gesture starts by detecting the first touch input and ends on releasing it.

### Requirements

To be able to use gesture support, the following needs to be considered:

- MT support needs to be enabled.
- Gesture support needs to be enabled via `WM_GESTURE_Enable()`.
- The flag `WM_CF_GESTURE` needs to be set by the according window.

### Supported gestures

The following table gives an overview of the currently supported gestures:

Gesture	Touch points	Description
<b>Panning</b>	1	Dependent on the first motion detection the gesture supports motion on one axis (X or Y) or both simultaneous.
<b>Zooming</b>	2	This gesture is started when detecting a relative motion between 2 touch points and can be used to scale an object. Can be combined with rotating and panning.
<b>Rotating</b>	2	When detecting initially a change of the angle between 2 touch points rotation gesture is started. Can be combined with zooming and panning.

### Processing gesture input

Gesture input is send to the according window by a `WM_GESTURE` message. For detailed gesture information a pointer to a structure of type `WM_GESTURE_INFO` (explained in detail below) is passed to the window. The "Flags" element of that structure is used to specify the kind of information passed to the window.

The supported flags are listed under *MultiTouch gesture flags* on page 3036.

The structure explained under `WM_GESTURE_INFO` on page 3033 explains all elements which are relevant for processing gesture messages. The `pZoomInfo` element should not be used by the application.

### Example

The sample folder of emWin contains the sample `MTOUCH_ScratchAndGestures.c`. It can be used to get more familiar with processing gestures and MT support. It contains a sub sample which animates a small vector graphic by gesture functions.

### Screenshot

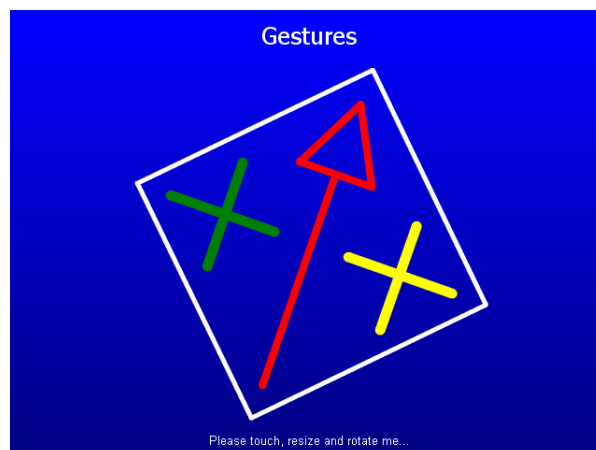

## 7.7.5 Window animation

Automatic window animation can be used to scale and pan windows automatically by gesture input. Currently that feature can be used for bare windows and can not be used with any of the widgets. Scaling of objects shown within scaled windows need to be done by the application. For that purpose the element "Factor" of the `WM_GESTURE_INFO` structure can be used as explained in the following.

### Requirements

To be able to use automatic window animation, the following needs to be considered:

- MT support needs to be enabled.
- Gesture support needs to be enabled via `WM_GESTURE_Enable()`.
- The window flags `WM_CF_GESTURE` and `WM_CF_ZOOM` need to be set.
- The window has to pass a pointer to a `WM_ZOOM_INFO` structure on demand.

### Reacting on gestures

Processing automatic window animation is similar to bare gesture support with the difference, that the object to be animated is the window itself which is modified automatically by `emWin`. But to be able to do this automatic animation the window manager needs additional information. This is done by passing a pointer to a `WM_ZOOM_INFO` structure to the WM. It is passed by the `pZoomInfo` element of the structure `WM_GESTURE_INFO`.

### Limits

The window to be animated can be moved and scaled by using the parent window as a kind of view port. If the size of the animated window is larger than the parent the WM makes sure that the zoomed window covers the complete area of the parent window. If it is smaller the WM makes sure, that it is not moved over the parents border.

### Scalable fonts

Text can be rendered at different sizes using scalable TrueType fonts. This requires a fast CPU and a reasonable amount of RAM and ROM. Details can be found in the chapter *TrueType Font (TTF) format* on page 662.

## 7.7.6 Basic buffer access API

The table below lists the available MT buffer access routines in alphabetical order. Detailed descriptions follow:

### Functions

Routine	Description
<code>GUI_MTOUCH_Enable()</code>	This routine needs to be called to enable the MT buffer.
<code>GUI_MTOUCH_GetEvent()</code>	Returns an event and removes it from the buffer.
<code>GUI_MTOUCH_GetTouchInput()</code>	This function is responsible for getting information of a dedicated touch point.
<code>GUI_MTOUCH_IsEmpty()</code>	Returns if the MT buffer is empty or not.
<code>GUI_MTOUCH_SetOrientation()</code>	This function can be used to set the touch screen orientation, e.g.
<code>GUI_MTOUCH_StoreEvent()</code>	Routine to be used by the touch screen driver to store a new event with associated touch points into the MT buffer.

### Data structures

Structure	Description
<code>GUI_MTOUCH_EVENT</code>	Data structure used by <code>GUI_MTOUCH_GetEvent()</code> to store a multi touch event in.
<code>GUI_MTOUCH_INPUT</code>	Data structure used by <code>GUI_MTOUCH_GetEvent()</code> to store a multi touch event in.
<code>WM_GESTURE_INFO</code>	Stores the information about a gesture.
<code>WM_ZOOM_INFO</code>	

### Defines

Group of defines	Description
<code>MultiTouch flags</code>	Data structure used by <code>GUI_MTOUCH_GetEvent()</code> to store a multi touch event in.
<code>MultiTouch gesture flags</code>	Flags used for processing gesture input.



## 7.7.6.1 Functions

### 7.7.6.1.1 GUI\_MTOUCH\_Enable()

#### Description

This routine needs to be called to enable the MT buffer.

#### Prototype

```
void GUI_MTOUCH_Enable(int OnOff);
```

#### Parameters

Parameter	Description
OnOff	1 for enabling the buffer, 0 for disabling.

### 7.7.6.1.2 GUI\_MTOUCH\_GetEvent()

#### Description

Returns an event and removes it from the buffer.

#### Prototype

```
int GUI_MTOUCH_GetEvent(GUI_MTOUCH_EVENT * pEvent);
```

#### Parameters

Parameter	Description
<code>pEvent</code>	Pointer to a structure of type <code>GUI_MTOUCH_EVENT</code> to be filled by the function.

#### Return value

- 0 on success
- 1 if the function fails. Can be used to check if an event was available or not.

#### Additional information

The most important information returned by that function is the availability of an event and how many touch points are available. Further the time stamp may be of interest which is filled automatically on storing an event into the buffer.

### 7.7.6.1.3 GUI\_MTOUCH\_GetTouchInput()

#### Description

This function is responsible for getting information of a dedicated touch point. It requires a pointer to a `GUI_MTOUCH_EVENT` structure previously filled by `GUI_MTOUCH_GetEvent()` and a pointer to a `GUI_MTOUCH_INPUT` structure to be filled by this function with the touchpoint details.

#### Prototype

```
int GUI_MTOUCH_GetTouchInput (GUI_MTOUCH_EVENT * pEvent,
                             GUI_MTOUCH_INPUT * pInput,
                             unsigned          Index);
```

#### Parameters

Parameter	Description
<code>pEvent</code>	Pointer to the event structure filled by <code>GUI_MTOUCH_GetEvent()</code> .
<code>pBuffer</code>	Pointer to a structure of type <code>GUI_MTOUCH_INPUT</code> to be filled by the function.
<code>Index</code>	<code>Index</code> of the requested touch point.

#### Return value

0        on success  
1        on error.

#### Additional information

The parameter `Index` needs to be < the available number of touch points. A unique `Id` is normally managed the touch controller which is passed by the `Id` element of `GUI_MTOUCH_INPUT`.

#### 7.7.6.1.4 GUI\_MTOUCH\_IsEmpty()

##### Description

Returns if the MT buffer is empty or not.

##### Prototype

```
int GUI_MTOUCH_IsEmpty(void);
```

##### Return value

1        if buffer is empty.  
0        if it contains MT events.

### 7.7.6.1.5 GUI\_MTOUCH\_SetOrientation()

#### Description

This function can be used to set the touch screen orientation, e.g. if the display does not operate by the default orientation or if the display orientation is different to the MT orientation.

#### Prototype

```
void GUI_MTOUCH_SetOrientation(int Orientation);
```

#### Parameters

Parameter	Description
<a href="#">Orientation</a>	One or more "OR" combined values of the table below

### 7.7.6.1.6 GUI\_MTOUCH\_StoreEvent()

#### Description

Routine to be used by the touch screen driver to store a new event with associated touch points into the MT buffer. The number of available touch points is passed by the `NumPoints` element of the structure pointed by `pEvent`. `pInput` then points to an array of `GUI_MTOUCH_INPUT` structures containing the information of each touch point.

#### Prototype

```
void GUI_MTOUCH_StoreEvent(GUI_MTOUCH_EVENT * pEvent,  
                           GUI_MTOUCH_INPUT * pInput);
```

#### Parameters

Parameter	Description
<code>pEvent</code>	Pointer to a structure of type <code>GUI_MTOUCH_EVENT</code> .
<code>pInput</code>	Pointer to the first element of an array of <code>GUI_MTOUCH_INPUT</code> structures.

#### Additional information

The number of possible touch points is limited per default to 10. The new event will automatically get a time stamp information which can be used later.

#### Note

Make sure that the element `Id` of `GUI_MTOUCH_INPUT` is  $\neq 0$ .

## 7.7.6.2 Data structures

### 7.7.6.2.1 GUI\_MTOUCH\_EVENT

#### Description

Data structure used by `GUI_MTOUCH_GetEvent()` to store a multi touch event in.

#### Type definition

```
typedef struct {  
    int          LayerIndex;  
    unsigned     NumPoints;  
    GUI_TIMER_TIME TimeStamp;  
    PTR_ADDR     hInput;  
} GUI_MTOUCH_EVENT;
```

#### Structure members

Member	Description
<code>LayerIndex</code>	Layer index of touched layer (normally 0).
<code>NumPoints</code>	Number of available touch points.
<code>TimeStamp</code>	Time stamp in ms of that event.
<code>hInput</code>	Internal use.

### 7.7.6.2.2 GUI\_MTOUCH\_INPUT

#### Description

Data structure used by `GUI_MTOUCH_GetEvent()` to store a multi touch event in.

#### Type definition

```
typedef struct {  
    I32  x;  
    I32  y;  
    U32  Id;  
    U16  Flags;  
} GUI_MTOUCH_INPUT;
```

#### Structure members

Member	Description
<code>x</code>	X-position in pixels of the touch point.
<code>y</code>	Y-position in pixels of the touch point.
<code>Id</code>	Unique <code>Id</code> , should be provided by the touch driver. Make sure that this element is $\neq 0$ .
<code>Flags</code>	See <i>MultiTouch flags</i> on page 3035.



### 7.7.6.2.3 WM\_GESTURE\_INFO

#### Description

Stores the information about a gesture.

#### Type definition

```
typedef struct {
    int          Flags;
    GUI_POINT    Point;
    GUI_POINT    Center;
    I32          Angle;
    I32          Factor;
    WM_ZOOM_INFO * pZoomInfo;
} WM_GESTURE_INFO;
```

#### Structure members

Member	Description
<a href="#">Flags</a>	Information regarding gesture type. See <i>MultiTouch gesture flags</i> on page 3036.
<a href="#">Point</a>	Relative movement to be processed by the application.
<a href="#">Center</a>	<a href="#">Center</a> point for zooming.
<a href="#">Angle</a>	Relative angle difference to be processed by the application.
<a href="#">Factor</a>	When starting a zoom gesture the application has to set the element to the initial value for the gesture. After that during the gesture it contains the updated value to be processed by the application.
<a href="#">pZoomInfo</a>	Pointer to be set to a valid location of a <code>WM_ZOOM_INFO</code> structure. The application should keep sure, that the location remains valid during the gesture.

### 7.7.6.2.4 WM\_ZOOM\_INFO

#### Type definition

```
typedef struct {
    I32      FactorMin;
    I32      FactorMax;
    U32      xSize;
    U32      ySize;
    U32      xSizeParent;
    U32      ySizeParent;
    I32      Factor0;
    int      xPos0;
    int      yPos0;
    GUI_POINT Center0;
} WM_ZOOM_INFO;
```

#### Structure members

Member	Description
<a href="#">FactorMin</a>	Minimum factor to be used (<< 16).
<a href="#">FactorMax</a>	Maximum factor to be used (<< 16).
<a href="#">xSize</a>	Native <a href="#">xSize</a> of window to be zoomed in pixels.
<a href="#">ySize</a>	Native <a href="#">ySize</a> of window to be zoomed in pixels.
<a href="#">xSizeParent</a>	Internal use.
<a href="#">ySizeParent</a>	Internal use.
<a href="#">Factor0</a>	Internal use.
<a href="#">xPos0</a>	Internal use.
<a href="#">yPos0</a>	Internal use.
<a href="#">Center0</a>	Internal use.

## 7.7.6.3 Defines

### 7.7.6.3.1 MultiTouch flags

#### Description

Data structure used by `GUI_MTOUCH_GetEvent()` to store a multi touch event in.

#### Definition

```
#define GUI_MTOUCH_FLAG_DOWN    (1 << 0)
#define GUI_MTOUCH_FLAG_MOVE   (1 << 1)
#define GUI_MTOUCH_FLAG_UP     (1 << 2)
```

#### Symbols

Definition	Description
<a href="#">GUI_MTOUCH_FLAG_DOWN</a>	New touch point has touched the surface.
<a href="#">GUI_MTOUCH_FLAG_MOVE</a>	Touch point has been moved.
<a href="#">GUI_MTOUCH_FLAG_UP</a>	Touch point has released the surface.

### 7.7.6.3.2 MultiTouch gesture flags

#### Description

Flags used for processing gesture input.

#### Definition

```
#define WM_GF_BEGIN      (1 << 0)
#define WM_GF_END        (1 << 1)
#define WM_GF_PAN        (1 << 2)
#define WM_GF_ZOOM       (1 << 3)
#define WM_GF_ROTATE     (1 << 4)
#define WM_GF_DTAP       (1 << 5)
```

#### Symbols

Definition	Description
<a href="#">WM_GF_BEGIN</a>	This flag is set when sending the first message for the gesture.
<a href="#">WM_GF_END</a>	Set when releasing a touch point at the end of a gesture.
<a href="#">WM_GF_PAN</a>	A panning gesture is detected. The element "Point" of WM_GESTURE_INFO contains the relative movement in pixels to be processed by the application.
<a href="#">WM_GF_ZOOM</a>	Zooming is active. When starting a zooming gesture the element "Factor" of WM_GESTURE_INFO has to be set to the initial value to be used by the gesture. During the gesture the same element contains the updated value to be processed by the application. If movement should be considered simultaneously the element "Point" contains also the relative movement.
<a href="#">WM_GF_ROTATE</a>	Rotation is active. The element "Angle" of WM_GESTURE_INFO contains the relative movement in degrees (<< 16) to be processed by the application. To be able to achieve a smooth rotation the value is passed in 1/65536 degrees. If movement should be considered simultaneously the element "Point" contains also the relative movement.
<a href="#">WM_GF_DTAP</a>	Internal use.

## 7.8 VNC Server

The emWin VNC server can be used for administration of the embedded target and a variety of other purposes. It supports compressed (hextile) encoding. VNC stands for 'Virtual Network Computing'. It is a client server system based on a simple display protocol which allows the user to view and control a computing 'desktop' environment from anywhere on the Internet and from a wide variety of machine architectures, communicating via TCP/IP.

In other words: The display contents of the embedded device are visible on the screen of the machine running the client (for example, your PC); your mouse and keyboard can be used to control the target.

This feature is available in the emWin simulation and trial versions. emWin VNC support is available as a separate package and is therefore not included in the basic package. VNC support requires emWin color.

If a file system is available, it is possible to achieve file transfers between client and target together with the emWin VNC client.

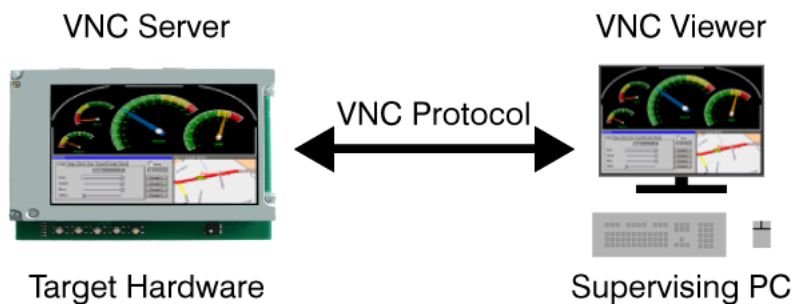

## 7.8.1 Introduction

VNC consists of two types of components. A server, which generates a display, and a viewer, which actually draws the display on your screen. The remote machine (target or simulation) can not only be viewed, but also controlled via mouse or keyboard. The server and the viewer may be on different machines and on different architectures. The protocol (RFB V3.3) which connects the server and viewer is simple, open, and platform independent. No state is stored at the viewer. Breaking the viewer's connection to the server and then reconnecting will not result in any loss of data. Because the connection can be remade from somewhere else, you have easy mobility. Using the VNC server, you may control your target from anywhere and you can make screenshots (for example, for a manual) from a "live" system.

### 7.8.1.1 Filetransfer

In addition to the default functionality of RFB V3.3 the emWin VNC server supports file transfers. Please note that file transfer is not part of the RFB protocol.

#### **Only supported client for file transfer is emVNC**

There does not exist a standard for file transfer operations within the RFB protocol. Because of that it requires a non-standard protocol extension which only works with the emVNC client. Only emVNC can be used for file transfers between the emWin VNC server and the client machine.

### 7.8.1.2 Requirements

#### **TCP/IP stack**

Since the communication between the server and the viewer is based on a TCP/IP connection, VNC requires a TCP/IP stack. In the Win32 simulation environment, TCP/IP (Winsock) is normally present. In the target, a TCP/IP stack needs to be present. The TCP/IP stack is NOT part of emWin. The flexible interface ensures that any TCP/IP stack can be used.

#### **Multi tasking**

The VNC server needs to run as a separate thread. Therefore a multi tasking system is required to use the emWin VNC server.

#### **File system (only for file transfers)**

A file system is required only if the file transfer feature should be used.

### 7.8.1.3 Notes on this implementation

#### **Supported client to server messages**

The emWin VNC server supports pointer event messages and keyboard event messages.

#### **Encoding**

The server supports raw encoding and hextile encoding.

#### **Performance**

Most viewers support hextile encoding, which supports descent compression. A typical quarter VGA screen requires typically 20 - 50 KB of data.

The server handles incremental updates; in most cases the updated display area is a lot smaller than the entire display and less data needs to be transmitted.

The following table shows some performance examples:

Hardware / Configuration	ms / screen
STM32F4, 168MHz, internal RAM, WQVGA, 16bpp, HexTile	32 ms
STM32F4, 168MHz, internal RAM, WQVGA, 16bpp, Raw	76 ms
ARM7, 50MHz, external RAM cached, QVGA, 16bpp, HexTile	250 ms

### Multiple servers

The implementation is fully thread safe and reentrant; multiple VNC-servers can be started on the same CPU for different layers or displays. If the target (of course the same holds true for the simulation) has multiple displays or multiple layers, this can be a useful option.

### Multiple connections

Multiple to the same layer are possible, given that for each connection a task and a `GUI_VNC_CONTEXT` structure is created.

## 7.8.2 emVNC client

The emVNC client is part of the emWin basic package and can be found in the tools folder as emVNC.exe. It can be used to establish a VNC connection from an MS Windows system to a VNC server. The viewer uses the RFB protocol 3.3. It has been tested with different VNC servers including the emWin VNC server, as well as TightVNC and RealVNC.

### 7.8.2.1 How to connect to a VNC-server

Once emVNC is started, it prompts for typing the network address of a VNC server to connect with:



#### Connecting to a VNC server using the simulation on the same PC

A VNC server running on the local host can be accessed by entering:

`localhost`

Alternatively connecting to `localhost` could be done by hitting the <RETURN> key or by pressing the "Connect" button while the text control is left empty.

#### Connecting to a VNC server running on a different PC or the target

In order to connect to a system in the network the IP address or the name has to be entered:

`192.168.1.14` or `Paul02`

Additionally the server index can be specified in order to connect to a certain server:

`192.168.1.14:1` or `Paul02:1`

#### Screenshot

The following screenshots show the viewer:

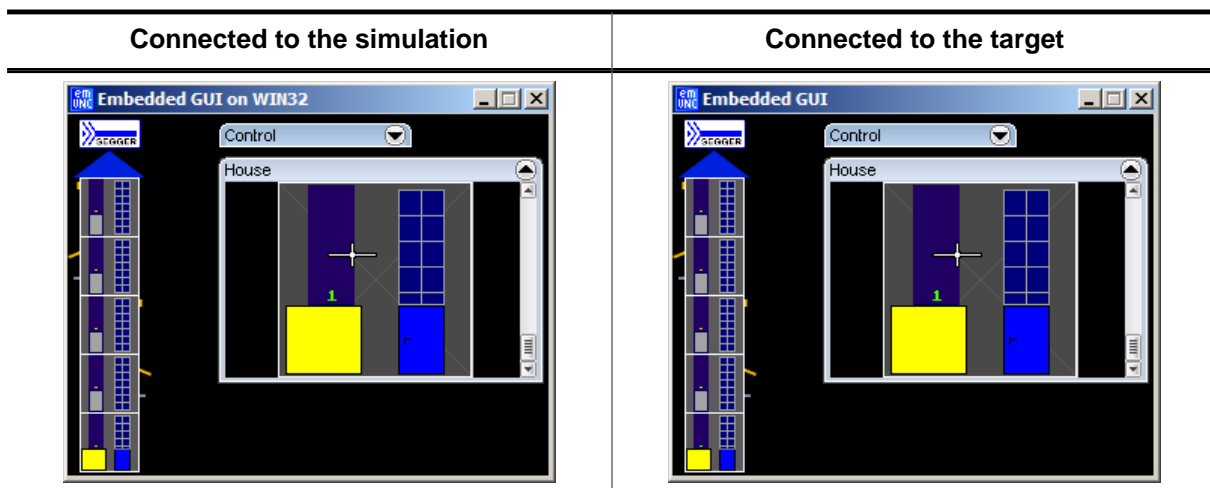

### 7.8.2.2 Opening the file transfer dialog

To spare a constantly visible menu bar in the VNC client, we added the menu option for opening the file transfer dialog to the system menu:



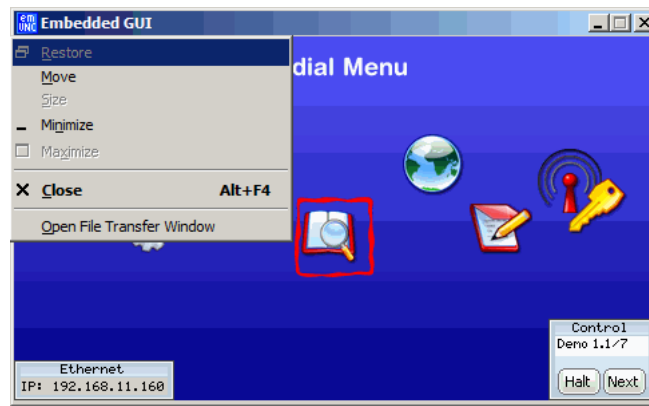

The system menu could be opened by a clicking on the upper left *emVNC* symbol or by the keyboard shortcut <ALT>+<SPACE>.

### Note

The menu option 'Open file transfer window' is only available if the connected server has been started with file transfer support.

## 7.8.2.3 The file transfer window

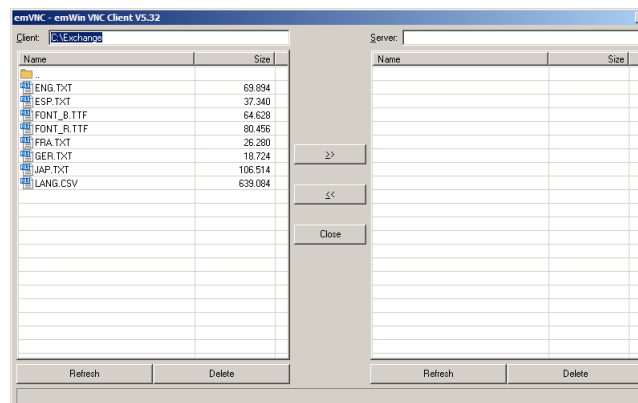

The above shown file transfer window is divided into a server- and a client side. It shows the content of the currently selected directories of both sides. The following operations are available:

### Selecting (multiple) files

Single clicking multiple files during <STRG> is pressed or moving the cursor with <UP> or <DOWN> to the desired file(s) and press <SPACE> while <STRG> is pressed.

### Single file transfer

Double-clicking a file starts a single transfer to the opposite side.

### Transfer selected files

The buttons >> and << can be used for starting the transfer from client to server >> or from server to client <<.

### Deleting selected files

The **Delete** buttons can be used to delete the selected files from server or client.

### Refreshing content

Pressing the **Refresh** button updates the content.

### Closing the file transfer window

Pressing <ESC> or the **Close** button

## 7.8.2.4 Connecting with a web browser

### Prerequisites

Additionally to an IP task, a webserver task is also necessary for a browser connection.

The example under `Sample\GUI_X\GUI_VNC_X_StartServer.c` contains an implementation using emNet for the IP and webserver stack and embOS as the operating system. The implementation can be adapted to different operating systems and/or IP stacks.

### How to connect

Connecting with a web browser via WebSocket is also possible. **noVNC** is a free and open-source client that can be used.

#### Note

Before noVNC can be used with newer Firefox versions, the option `privacy.file_unique_origin` has to be set to `false` under `about:config`.

To connect, simply enter the target IP and the port 80. The path to be used is "websocketify".

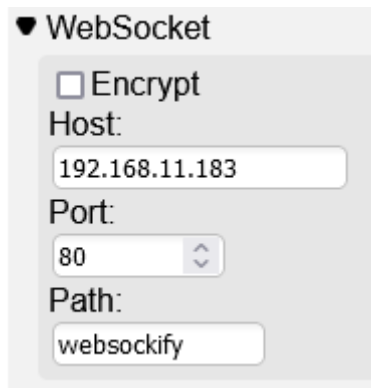

Multiple connections are also possible through the browser, as long as a task and a `GUI_VNC_CONTEXT` structure is created for each desired connection.

## 7.8.3 emWin VNC server

### 7.8.3.1 Starting the emWin VNC server

The one and only thing to start the VNC server is to call the function `GUI_VNC_X_StartServer()`:

```
void MainTask(void) {
    GUI_Init();
    GUI_VNC_X_StartServer(0, // Layer index
                        0); // Server index
    ...
}
```

The above function call creates a thread which listens on port 5900 for an incoming connection. After a connection has been detected `GUI_VNC_Process()` will be called.

#### Ports

The VNC server listens on port 590x, where x is the server index. So for most PC servers, the port will be 5900, because they use display 0 by default.

### 7.8.3.2 Enabling file transfer support

File transfer is enabled by calling `GUI_VNC_X_StartServerFT()` instead of `GUI_VNC_X_StartServer()`. In addition to the task of starting the VNC-thread it sets an API-table containing function pointers for file access. Further it enables the RFB protocol extensions required for file transfers.

### 7.8.3.3 Starting the VNC server in the simulation

The simulation library contains a ready to use implementation of the function `GUI_VNC_X_StartServer()` which simply needs to be called by the application code. It creates a thread which listens on port 590x until an incoming connection is detected and then calls `GUI_VNC_Process()`, which is the implementation of the actual server.

### 7.8.3.4 Example of starting the VNC server on the target system

To be able to use the VNC server on the target it is required to have an implementation of `GUI_VNC_X_StartServer()` or `GUI_VNC_X_StartServerFT()` which works with the available IP library and in case of using file transfer also with the available file system. A ready to use implementation of that function which works with emNet and emFile is available under `Sample\GUI_X\GUI_VNC_X_StartServer.c`.

Since this example does not use dynamic memory allocation to allocate memory for the `GUI_VNC_CONTEXT` structure and task(s), the maximum number of connections has to be specified with the `VNC_MAX_CONNECTIONS` define.

This sample could also be used as starting point for adapting it to other libraries than emNet and emFile. Only small changes should be required in that case.

## 7.8.4 RAM and ROM requirements

#### ROM

About 4.9 KB on ARM7 with hextile encoding, about 3.5 KB without hextile encoding.

#### RAM

The VNC support does not use static data. For each instance one `GUI_VNC_CONTEXT` structure (approx. 60 bytes) is used.

## Others

Each instance needs one TCP/IP socket and one thread.

## 7.8.5 VNC Server API

The following table lists the available VNC-related functions in alphabetical order. Detailed function descriptions follow:

### Functions

Routine	Description
<code>GUI_VNC_AttachToLayer()</code>	Attaches a VNC server to a layer. Without a MultiLayer configuration the given index must be 0.
<code>GUI_VNC_EnableFileTransfer()</code>	Enables file transfer extension.
<code>GUI_VNC_EnableKeyboardInput()</code>	Enables or disables keyboard input via VNC.
<code>GUI_VNC_GetNumConnections()</code>	Returns the number of connections to the server.
<code>GUI_VNC_Process()</code>	The actual VNC server; initializes the communication with the viewer.
<code>GUI_VNC_RingBell()</code>	Rings a bell on the client if it has one.
<code>GUI_VNC_SetFS_API()</code>	Sets a function table used for file access.
<code>GUI_VNC_SetLockFrame()</code>	Configures the VNC server not to read the display while the GUI performs drawing operations.
<code>GUI_VNC_SetPassword()</code>	Sets the password required to connect with the server.
<code>GUI_VNC_SetProgName()</code>	Sets the text to be shown in the viewers title bar.
<code>GUI_VNC_SetRetryCount()</code>	Sets the number of additional trials in case of a write error.
<code>GUI_VNC_SetSize()</code>	Sets the area to be transmitted to the client.
<code>GUI_VNC_X_StartServer()</code>	Routine to be called to start a thread listening for an incoming connection and executing the VNC server.
<code>GUI_VNC_X_StartServerFT()</code>	Same as above with file transfer support.

### Data structures

Structure	Description
<code>IP_FS_API</code>	Table containing the function pointers for file access.

## 7.8.5.1 Functions

### 7.8.5.1.1 GUI\_VNC\_AttachToLayer()

#### Description

This function attaches the given layer to the VNC server.

#### Prototype

```
void GUI_VNC_AttachToLayer(GUI_VNC_CONTEXT * pContext,  
                           int LayerIndex);
```

#### Parameters

Parameter	Description
<code>pContext</code>	Pointer to a GUI_VNC_CONTEXT structure.
<code>LayerIndex</code>	Zero-based index of layer to be handled by the server. Normally, with single layer configurations, this parameter should be 0.

#### Return value

= 0      if the function succeed  
≠ 0      if the function fails.

### 7.8.5.1.2 GUI\_VNC\_EnableFileTransfer()

#### Description

Enables or disables the file transfer extension.

#### Prototype

```
void GUI_VNC_EnableFileTransfer(unsigned OnOff);
```

#### Parameters

Parameter	Description
OnOff	1 for enabling keyboard input, 0 for disabling.

#### Return value

= 0 if the function succeeds.

≠ 0 if the function fails.

#### Additional information

This routine needs to be called by `GUI_VNC_X_StartServerFT()` for enabling file transfer in the protocol. Please also refer to the sample code under `Sample\GUI_X\GUI_VNC_X_StartServer.c` which shows how to enable file transfer on the target.

### 7.8.5.1.3 GUI\_VNC\_EnableKeyboardInput()

#### Description

Enables or disables keyboard input via VNC.

#### Prototype

```
void GUI_VNC_EnableKeyboardInput(int OnOff);
```

#### Parameters

Parameter	Description
OnOff	1 for enabling keyboard input, 0 for disabling.

#### 7.8.5.1.4 GUI\_VNC\_GetNumConnections()

##### Description

Returns the number of currently existing connections to the server.

##### Prototype

```
int GUI_VNC_GetNumConnections(void);
```

##### Return value

Number of connections.



### 7.8.5.1.5 GUI\_VNC\_Process()

#### Description

The function sets the send and receive function used to send and receive data and starts the communication with the viewer.

#### Prototype

```
int GUI_VNC_Process(GUI_VNC_CONTEXT * pContext,
                   GUI_tSend       pfSend,
                   GUI_tRecv       pfReceive,
                   void             * pConnectInfo);
```

#### Parameters

Parameter	Description
<code>pContext</code>	Pointer to a <code>GUI_VNC_CONTEXT</code> structure.
<code>pfSend</code>	Pointer to the function to be used by the server to send data to the viewer.
<code>pfReceive</code>	Pointer to the function to be used by the server to read from the viewer.
<code>pConnectInfo</code>	Pointer to be passed to the send and receive function.

#### Additional information

The `GUI_VNC_CONTEXT` structure is used by the server to store connection state information. The send and receive functions should return the number of bytes successfully send/received to/from the viewer. The pointer `pConnectInfo` is passed to the send and receive routines. It can be used to pass a pointer to a structure containing connection information or to pass a socket number. The following types are used as function pointers to the routines used to send and receive bytes from/to the viewer:

```
typedef int (* GUI_tSend) (const U8 * pData,
                          int         len,
                          void        * pConnectInfo);

typedef int (* GUI_tReceive) (U8 * pData,
                              int   len,
                              void  * pConnectInfo);
```

#### Example

```
static GUI_VNC_CONTEXT _Context; /* Data area for server */
static int _Send(const U8* buf, int len, void * pConnectionInfo) {
    SOCKET Socket = (SOCKET)pConnectionInfo;
    ...
}
static int _Recv(U8* buf, int len, void * pConnectionInfo) {
    SOCKET Socket = (SOCKET)pConnectionInfo;
    ...
}
static void _ServerTask(void) {
    int Socket;
    ...
    GUI_VNC_Process(&_Context, _Send, _Recv, (void *)Socket);
    ...
}
```

### 7.8.5.1.6 GUI\_VNC\_RingBell()

#### Description

Ring a bell on the client if it has one.

#### Prototype

```
void GUI_VNC_RingBell(void);
```

### 7.8.5.1.7 GUI\_VNC\_SetFS\_API()

#### Note

The following description of the `IP_FS_API` structure is an excerpt of the document **UM07001 User & Reference Guide for embOS/IP** which is also available separately on [www.segger.com](http://www.segger.com).

#### Description

Sets a function table used for accessing files.

#### Prototype

```
void GUI_VNC_SetFS_API(const IP_FS_API * pFS_API);
```

#### Parameters

Parameter	Description
<code>pFS_API</code>	Pointer to an <code>IP_FS_API</code> structure containing function pointers for file access.

#### Additional information

This routine needs to be called by `GUI_VNC_X_StartServerFT()` for enabling file transfer in the protocol. Please also refer to the sample code under `Sample\GUI_X\GUI_VNC_X_StartServer.c` which shows how to enable file transfer on the target.

### 7.8.5.1.8 GUI\_VNC\_SetLockFrame()

#### Description

Configures the VNC server not to read the display while the GUI performs drawing operations.

#### Prototype

```
void GUI_VNC_SetLockFrame(unsigned OnOff);
```

#### Parameters

Parameter	Description
OnOff	If set to a value >0 frame locking will be enabled. Default is enabled frame locking.

#### Additional information

This can be configured at compile time by using the compile time switch `GUI_VNC_LOCK_FRAME`.

### 7.8.5.1.9 GUI\_VNC\_SetPassword()

#### Description

Sets a password required to connect to the server.

#### Prototype

```
void GUI_VNC_SetPassword(U8 * sPassword);
```

#### Parameters

Parameter	Description
<code>sPassword</code>	Password required to connect to the server.

#### Additional information

Per default no password is required. If a password is set the server creates a random challenge of 16 Bytes and encrypts it using DES. The unencrypted challenge is sent to the client and should return encrypted. If the client's response matches the encrypted challenge, authentication was successful.

### 7.8.5.1.10 GUI\_VNC\_SetProgName()

#### Description

Sets the title to be displayed in the title bar of the client window.

#### Prototype

```
void GUI_VNC_SetProgName(const char * sProgName);
```

#### Parameters

Parameter	Description
<code>sProgName</code>	Title to be displayed in the title bar of the client window.

### 7.8.5.1.11 GUI\_VNC\_SetRetryCount()

#### Description

Sets the number of additional trials in case of an error when trying to write data on the line.

#### Prototype

```
void GUI_VNC_SetRetryCount(unsigned Cnt);
```

#### Parameters

Parameter	Description
Cnt	Number of additional trials to be used in case of an error (default is 0).

### 7.8.5.1.12 GUI\_VNC\_SetSize()

#### Description

Sets the display size to be transmitted to the client.

#### Prototype

```
void GUI_VNC_SetSize(unsigned xSize,  
                    unsigned ySize);
```

#### Parameters

Parameter	Description
<code>xSize</code>	X-size to be used.
<code>ySize</code>	Y-size to be used.

#### Additional information

Per default the server uses the layer size. The size passed to this function can be smaller or larger than the real display.



### 7.8.5.1.13 GUI\_VNC\_X\_StartServer()

#### Description

This function has to start a thread listening for an incoming connection. If a connection is established it has to execute the actual VNC server `GUI_VNC_Process()`. The function has to be supplied by the customer because the implementation depends on the used TCP/IP stack and on the used operating system. The emWin shipment contains an example implementation under `Sample\GUI_X\GUI_VNC_X_StartServer.c`. It could be used as a starting point for adapting it to other systems.

#### Prototype

```
int GUI_VNC_X_StartServer(int LayerIndex,  
                          int ServerIndex);
```

#### Parameters

Parameter	Description
<code>LayerIndex</code>	Layer to be shown by the viewer.
<code>ServerIndex</code>	Server index.

#### Return value

0        OK.  
-1       Error.

#### Additional information

There is no difference to start a VNC server in the simulation or on the target. In both cases you should call this function. The simulation contains an implementation of this function, the hardware implementation has to be done by the customer.

### 7.8.5.1.14 GUI\_VNC\_X\_StartServerFT()

#### Description

Function which has to be implemented by the customer to start the VNC server with file transfer support. Additionally to starting a server thread the function has to enable the file transfer extensions by calling `GUI_VNC_EnableFileTransfer()` and it has to set a function table to be used for file access by `GUI_VNC_SetFS_API()`.

#### Prototype

```
int GUI_VNC_X_StartServerFT(int LayerIndex,  
                           int ServerIndex);
```

#### Parameters

Parameter	Description
<code>LayerIndex</code>	Layer to be shown by the viewer.
<code>ServerIndex</code>	Server index.

#### Return value

Returns 0.

#### Additional information

Under `Sample\GUI_X\GUI_VNC_X_StartServer.c` a sample is available which shows a sample implementation using `embOS/IP` and `emFile`.

## 7.8.5.2 Data structures

### 7.8.5.2.1 IP\_FS\_API

#### Description

Table containing the function pointers for file access.

#### Type definition

```
typedef struct {
    void * (* pfOpenFile)                (const char * sFilename,
                                         const char * sOpenFlags                );
    int    (* pfCloseFile)                (void * hFile                );
    int    (* pfReadAt)                   (void * hFile,
                                         void * pBuffer,
                                         U32    Pos,
                                         U32    NumBytes                );
    long   (* pfGetLen)                   (void * hFile                );
    void   (* pfForEachDirEntry)          (void * pContext,
                                         const char * sDir,
                                         void (* pf) (void * pContext,
                                                       void * pFileEntry));
    void   (* pfGetDirEntryFileName)      (void * pFileEntry,
                                         char * sFileName,
                                         U32    SizeOfBuffer                );
    U32    (* pfGetDirEntryFileSize)      (void * pFileEntry,
                                         U32    * pFileSizeHigh                );
    int    (* pfGetDirEntryFileTime)      (void * pFileEntry                );
    U32    (* pfGetDirEntryAttributes)    (void * pFileEntry                );
    void * (* pfCreate)                   (const char * sFileName                );
    void * (* pfDeleteFile)               (const char * sFilename                );
    int    (* pfRenameFile)               (const char * sOldFilename,
                                         const char * sNewFilename                );
    int    (* pfWriteAt)                   (void * hFile,
                                         void * pBuffer,
                                         U32    Pos,
                                         U32    NumBytes                );
    int    (* pfMKDir)                    (const char * sDirName                );
    int    (* pfRMDir)                    (const char * sDirName                );
    int    (* pfIsFolder)                  (const char * sPath                );
    int    (* pfMove)                     (const char * sOldFilename,
                                         const char * sNewFilename                );
} IP_FS_API;
```

#### Structure members

Function	Description
Read only file system functions (required)	
<a href="#">pfOpenFile</a>	Pointer to a function that creates/opens a file and returns the handle of these file.
<a href="#">pfCloseFile</a>	Pointer to a function that closes a file.
<a href="#">pfReadAt</a>	Pointer to a function that reads a file.
<a href="#">pfGetLen</a>	Pointer to a function that returns the length of a file.
Directory query operations	
<a href="#">pfForEachDirEntry</a>	Pointer to a function which is called for each directory entry.
<a href="#">pfGetDirEntryFileName</a>	Pointer to a function that returns the name of a file entry.
<a href="#">pfGetDirEntryFileSize</a>	Pointer to a function that returns the size of a file.

Function	Description
<a href="#">pfGetDirEntryFileTime</a>	Pointer to a function that returns the timestamp of a file.
<a href="#">pfGetDirEntryAttributes</a>	Pointer to a function that returns the attributes of a directory entry.
Write file operations	
<a href="#">pfCreate</a>	Pointer to a function that creates a file.
<a href="#">pfDeleteFile</a>	Pointer to a function that deletes a file.
<a href="#">pfRenameFile</a>	Pointer to a function that renames a file.
<a href="#">pfWriteAt</a>	Pointer to a function that writes a file.
Additional directory operations (optional)	
<a href="#">pfMKDir</a>	Pointer to a function that creates a directory.
<a href="#">pfRMDir</a>	Pointer to a function that deletes a directory.
Additional operations (optional)	
<a href="#">pfIsFolder</a>	Pointer to a function that checks if a path is a folder.
<a href="#">pfMove</a>	Pointer to a function that moves a file or directory.

# Chapter 8

## Legacy features

---

The following chapter contains all features of emWin that are considered to be outdated. These features are still supported by emWin, but are not recommended to be used anymore.

- Sprites
- Cursors
- Virtual screens / Virtual pages

## 8.1 Sprites

### Note

When using sprites the background over which they are moved must not be drawn using RLE-compressed or alpha channel bitmaps.

A **sprite** is an image which can be shown above all other graphics on the screen. A sprite preserves the screen area it covers. It can be moved or removed at any time, fully restoring the screen content. Animation by use of multiple images is possible. Sprites are completely independent from all other drawing operations as well as window operations: sprites do not affect drawing or window operations; drawing or window operations do not affect sprites. Sprites can be seen as objects which are sitting “on top” of the screen, similar to cursors.

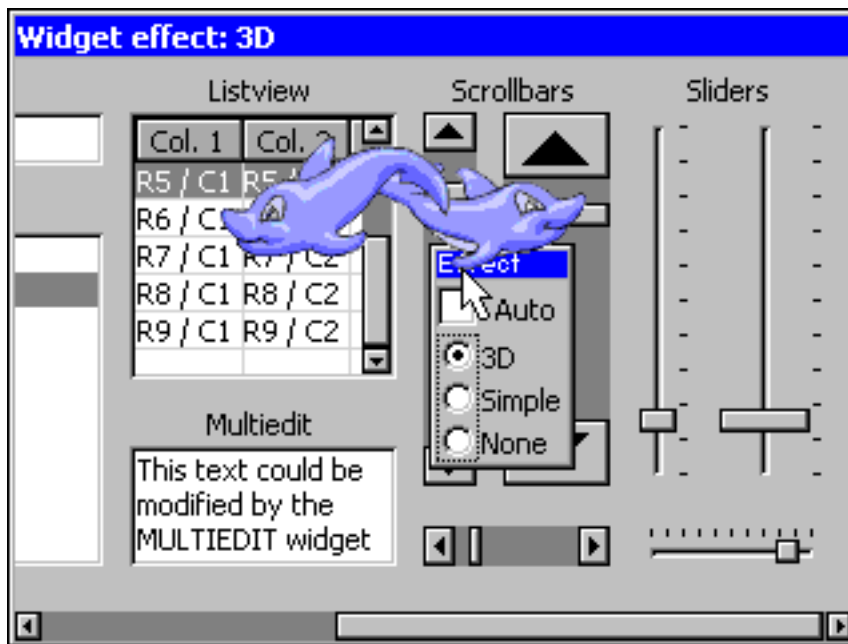

### 8.1.1 Introduction

emWin Sprites are implemented as a pure software solution. No additional hardware is required to use emWin Sprites. They can be shown, moved and deleted without affecting already visible graphics.

#### Memory requirements

Each sprite needs a memory area for saving the display data ‘behind’ the sprite to be able to restore the background on moving operations or on removing the sprite. Further a memory area for a color cache is required. The size of the color cache depends on the number of colors used in the sprite image. So the complete number of bytes required for a sprite can be calculated as follows:

```
SizeOfSpriteObject (~30 bytes) + (XSize * YSize + NumberOfBitmapColors) *
REQUIRED_BYTES_PER_PIXEL
```

#### Maximum number of Sprites

The number of simultaneous visible sprites is not limited by emWin. It depends only on the available memory.

## Performance

Note that drawing a sprite is more computer-bound than drawing a simple bitmap, because it has to manage the background data and intersections with other sprites.

## Z-order

Z-order is an ordering of overlapping two-dimensional objects, in this case the sprites. When two sprites overlap, their Z-order determines which one appears on top of the other. The sprite created at last is the topmost sprite.

## 8.1.2 Sprite API

The table below lists the available Sprite-related routines in alphabetical order. Detailed descriptions follow:

Routine	Description
<code>GUI_SPRITE_Create()</code>	Creates a Sprite at the given position in the current layer.
<code>GUI_SPRITE_CreateAnim()</code>	Creates an animated Sprite at the given position in the current layer.
<code>GUI_SPRITE_CreateEx()</code>	Creates a Sprite at the given position in the desired layer.
<code>GUI_SPRITE_CreateExAnim()</code>	Creates an animated Sprite at the given position in the current layer.
<code>GUI_SPRITE_CreateHidden()</code>	Creates a hidden Sprite at the given position in the current layer.
<code>GUI_SPRITE_CreateHiddenEx()</code>	Creates a hidden Sprite at the given position in the given layer.
<code>GUI_SPRITE_Delete()</code>	Deletes the given Sprite.
<code>GUI_SPRITE_GetState()</code>	Returns if the given Sprite is visible or not.
<code>GUI_SPRITE_Hide()</code>	Hides the given Sprite.
<code>GUI_SPRITE_SetBitmap()</code>	Sets a new image for drawing the Sprite.
<code>GUI_SPRITE_SetBitmapAndPosition()</code>	Sets the position and the image at once.
<code>GUI_SPRITE_SetLoop()</code>	Enables/Disables infinite animation of the given Sprite.
<code>GUI_SPRITE_SetPosition()</code>	Moves the Sprite to the new position.
<code>GUI_SPRITE_Show()</code>	Shows the given Sprite.
<code>GUI_SPRITE_StartAnim()</code>	Starts the animation of the given Sprite.
<code>GUI_SPRITE_StopAnim()</code>	Stops the animation of the given Sprite.

### 8.1.2.1 GUI\_SPRITE\_Create()

#### Description

Creates a Sprite at the given position in the current layer.

#### Prototype

```
GUI_HSPRITE GUI_SPRITE_Create(const GUI_BITMAP * pBM,  
                               int             x,  
                               int             y);
```

#### Parameters

Parameter	Description
<code>pBM</code>	Pointer to a bitmap structure to be used for drawing the Sprite.
<code>x</code>	X-position of the Sprite in screen coordinates.
<code>y</code>	Y-position of the Sprite in screen coordinates.

#### Return value

Handle of the new Sprite, 0 on failure.

#### Additional information

The bitmap addressed by the parameter `pBM` needs to agree with the following requirements:

- It should not be compressed.
- It needs to be transparent.
- It needs to be a palette based bitmap with 1, 2, 4 or 8bpp or, if semi transparency is required, a true color bitmap. Other bitmaps or insufficient memory cause the function to fail.



### 8.1.2.2 GUI\_SPRITE\_CreateAnim()

#### Description

Creates an animated Sprite at the given position in the current layer.

#### Prototype

```
GUI_HSPRITE GUI_SPRITE_CreateAnim(const GUI_BITMAP ** ppBm,
                                   int x,
                                   int y,
                                   unsigned Period,
                                   const unsigned * pPeriod,
                                   int NumItems);
```

#### Parameters

Parameter	Description
<code>ppBM</code>	Pointer to an array of bitmap pointers to be used for drawing the Sprite.
<code>x</code>	X-position of the Sprite in screen coordinates.
<code>y</code>	Y-position of the Sprite in screen coordinates.
<code>Period</code>	<code>Period</code> to be used to switch between the images.
<code>pPeriod</code>	Pointer to an array containing the periods to be used to switch between the images.
<code>NumItems</code>	Number of images.

#### Return value

Handle of the new Sprite, 0 on failure.

#### Additional information

The bitmaps addressed by the parameter `ppBM` needs to agree with the following requirements:

- They need to have exactly the same X- and Y-size.
- They should not be compressed.
- They need to be transparent.
- They need to be palette based bitmaps with 1, 2, 4 or 8bpp or, if semi-transparency is required, true color bitmaps. Using bitmaps which do not match above criteria causes the function to fail as well as insufficient memory. The parameter `pPeriod` is required, only if the periods for the images are different. If the same period should be used for all images the parameter `Period` should be used. In this case `pPeriod` can be `NULL`. In case `pPeriod` is used, the animation will stop at the according image if one of the timer values is 0.

### 8.1.2.3 GUI\_SPRITE\_CreateEx()

#### Description

Creates a Sprite at the given position in the desired layer.

#### Prototype

```
GUI_HSPRITE GUI_SPRITE_CreateEx(const GUI_BITMAP * pBM,  
                                int x,  
                                int y,  
                                int Layer);
```

#### Parameters

Parameter	Description
<a href="#">pBM</a>	Pointer to a bitmap structure to be used for drawing the Sprite.
<a href="#">x</a>	X-position of the Sprite in screen coordinates.
<a href="#">y</a>	Y-position of the Sprite in screen coordinates.
<a href="#">Layer</a>	<a href="#">Layer</a> of Sprite.

#### Return value

Handle of the new Sprite, 0 on failure.

#### Additional information

Additional information can be found under [GUI\\_SPRITE\\_Create\(\)](#).

### 8.1.2.4 GUI\_SPRITE\_CreateExAnim()

#### Description

Creates an animated Sprite at the given position in the current layer.

#### Prototype

```
GUI_HSPRITE GUI_SPRITE_CreateExAnim(const GUI_BITMAP ** ppBm,
                                     int x,
                                     int y,
                                     unsigned Period,
                                     const unsigned * pPeriod,
                                     int NumItems,
                                     int LayerIndex);
```

#### Parameters

Parameter	Description
<code>ppBM</code>	Pointer to an array of bitmap pointers to be used for drawing the Sprite.
<code>x</code>	X-position of the Sprite in screen coordinates.
<code>y</code>	Y-position of the Sprite in screen coordinates.
<code>Period</code>	<code>Period</code> to be used to switch between the images.
<code>pPeriod</code>	Pointer to an array containing values to be used to switch between the images.
<code>NumItems</code>	Number of images.
<code>LayerIndex</code>	Layer of Sprite.

#### Return value

Handle of the new Sprite, 0 on failure.

#### Additional information

Additional information can be found under `GUI_SPRITE_CreateAnim()`.

### 8.1.2.5 GUI\_SPRITE\_CreateHidden()

#### Description

Creates a hidden Sprite at the given position in the current layer.

#### Prototype

```
GUI_HSPRITE GUI_SPRITE_CreateHidden(const GUI_BITMAP * pBM,  
                                     int x,  
                                     int y);
```

#### Parameters

Parameter	Description
<a href="#">pBM</a>	Pointer to a bitmap structure to be used for drawing the Sprite.
<a href="#">x</a>	X-position of the Sprite in screen coordinates.
<a href="#">y</a>	Y-position of the Sprite in screen coordinates.

#### Return value

Handle of the new Sprite, 0 on failure.

#### Additional information

More details can be found in the description of `GUI_SPRITE_Create()`.

### 8.1.2.6 GUI\_SPRITE\_CreateHiddenEx()

#### Description

Creates a hidden Sprite at the given position in the given layer.

#### Prototype

```
GUI_HSPRITE GUI_SPRITE_CreateHiddenEx(const GUI_BITMAP * pBM,  
                                       int           x,  
                                       int           y,  
                                       int           Layer);
```

#### Parameters

Parameter	Description
<a href="#">pBM</a>	Pointer to a bitmap structure to be used for drawing the Sprite.
<a href="#">x</a>	X-position of the Sprite in screen coordinates.
<a href="#">y</a>	Y-position of the Sprite in screen coordinates.
<a href="#">Layer</a>	<a href="#">Layer</a> to be used.

#### Return value

Handle of the new Sprite, 0 on failure.

#### Additional information

More details can be found in the description of [GUI\\_SPRITE\\_Create\(\)](#).

### 8.1.2.7 GUI\_SPRITE\_Delete()

#### Description

Deletes the given Sprite.

#### Prototype

```
void GUI_SPRITE_Delete(GUI_HSPRITE hSprite);
```

#### Parameters

Parameter	Description
<code>hSprite</code>	Handle of Sprite to be deleted.

#### Additional information

The function deletes the Sprite from the memory and restores its background automatically.

### 8.1.2.8 GUI\_SPRITE\_GetState()

#### Description

Returns if the given Sprite is visible or not.

#### Prototype

```
int GUI_SPRITE_GetState(GUI_HSPRITE hSprite);
```

#### Parameters

Parameter	Description
<code>hSprite</code>	Handle of Sprite.

#### Return value

1 if the Sprite is visible.  
0 if not.

### 8.1.2.9 GUI\_SPRITE\_Hide()

#### Description

Hides the given Sprite.

#### Prototype

```
void GUI_SPRITE_Hide(GUI_HSPRITE hSprite);
```

#### Parameters

Parameter	Description
<code>hSprite</code>	Handle of Sprite to hide.

#### Additional information

The function removes the given Sprite from the list of visible Sprites.



### 8.1.2.10 GUI\_SPRITE\_SetBitmap()

#### Description

Sets a new image for drawing the Sprite.

#### Prototype

```
int GUI_SPRITE_SetBitmap(      GUI_HSPRITE  hSprite,  
                             const GUI_BITMAP * pBM);
```

#### Parameters

Parameter	Description
<code>hSprite</code>	Handle of Sprite.
<code>pBM</code>	Pointer to a bitmap structure to be used for drawing the Sprite.

#### Return value

0        on success  
1        on error.

#### Additional information

The new bitmap must have exact the same size as the previous one. Passing a pointer to a bitmap of a different size causes the function to fail. The function immediately replaces the visible Sprite image on the screen. No further operation is required for showing the new image.

### 8.1.2.11 GUI\_SPRITE\_SetBitmapAndPosition()

#### Description

Sets the position and the image at once.

#### Prototype

```
int GUI_SPRITE_SetBitmapAndPosition(    GUI_HSPRITE  hSprite,
                                       const GUI_BITMAP * pBM,
                                       int           x,
                                       int           y);
```

#### Parameters

Parameter	Description
<code>hSprite</code>	Handle of Sprite.
<code>pBM</code>	Pointer to the new bitmap structure to be used to draw the Sprite.
<code>x</code>	New X-position in screen coordinates.
<code>y</code>	New Y-position in screen coordinates.

#### Return value

0        on success  
1        on error.

#### Additional information

It makes a difference on using the functions `GUI_SPRITE_SetBitmap()` and `GUI_SPRITE_SetPosition()` one after another or using this function. Whereas the image on the screen will be rendered twice on calling `GUI_SPRITE_SetBitmap()` and `GUI_SPRITE_SetPosition()` it is rendered only once on using this function, which can be used very well in animations.

### 8.1.2.12 GUI\_SPRITE\_SetLoop()

#### Description

Enables/Disables infinite animation of the given Sprite.

#### Prototype

```
int GUI_SPRITE_SetLoop(GUI_HSPRITE hSprite,  
                       int          OnOff);
```

#### Parameters

Parameter	Description
<code>hSprite</code>	Handle of the Sprite.
<code>OnOff</code>	1 to enable infinite animation. 0 to disable it.

#### Return value

- 1 if the function failed.
- 0 if infinite animation was not previously set.
- 1 if infinite animation was previously set.

### 8.1.2.13 GUI\_SPRITE\_SetPosition()

#### Description

Moves the Sprite to the new position.

#### Prototype

```
void GUI_SPRITE_SetPosition(GUI_HSPRITE hSprite,  
                             int         x,  
                             int         y);
```

#### Parameters

Parameter	Description
<code>hSprite</code>	Handle of Sprite.
<code>x</code>	New X-position in screen coordinates.
<code>y</code>	New Y-position in screen coordinates.

#### Additional information

The function moves the given Sprite to the new position.

### 8.1.2.14 GUI\_SPRITE\_Show()

#### Description

Shows the given Sprite.

#### Prototype

```
void GUI_SPRITE_Show(GUI_HSPRITE hSprite);
```

#### Parameters

Parameter	Description
<code>hSprite</code>	Handle of Sprite.

#### Additional information

The function adds the given Sprite to the list of visible Sprites.

### 8.1.2.15 GUI\_SPRITE\_StartAnim()

#### Description

Starts the animation of the given Sprite.

#### Prototype

```
int GUI_SPRITE_StartAnim(GUI_HSPRITE hSprite);
```

#### Parameters

Parameter	Description
<code>hSprite</code>	Handle of Sprite.

#### Return value

0        on success  
1        on error.

### 8.1.2.16 GUI\_SPRITE\_StopAnim()

#### Description

Stops the animation of the given Sprite.

#### Prototype

```
int GUI_SPRITE_StopAnim(GUI_HSPRITE hSprite);
```

#### Parameters

Parameter	Description
<code>hSprite</code>	Handle of Sprite.

#### Return value

0        on success  
1        on error.

## 8.2 Cursors













**Note**

When using cursors the background over which they are moved must not be drawn using RLE-compressed or alpha channel bitmaps.

emWin includes a system-wide cursor which may be changed to other, predefined styles. Also automatically animated cursors are supported. Although the cursor always exists, it is hidden by default. It will not be visible until a call is made to show it, and may be hidden again at any point.

### 8.2.1 Available cursors

The following cursor styles are currently available. If a call to `GUI_CURSOR_Show()` is made and no style is specified with `GUI_CURSOR_Select()`, the default cursor will be a medium arrow.

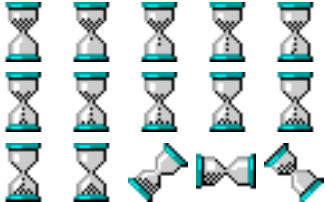
Arrow cursors		Cross cursors	
GUI_CursorArrowS Small arrow		GUI_CursorCrossS Small cross	
GUI_CursorArrowM Medium arrow (default cursor)		GUI_CursorCrossM Medium cross	
GUI_CursorArrowL Large arrow		GUI_CursorCrossL Large cross	
Inverted arrow cursors		Inverted cross cursors	
GUI_CursorArrowSI Small inverted arrow		GUI_CursorCrossSI Small inverted cross	
GUI_CursorArrowMI Medium inverted arrow		GUI_CursorCrossMI Medium inverted cross	
GUI_CursorArrowLI Large inverted arrow		GUI_CursorCrossLI Large inverted cross	
Animated cursors			
GUI_CursorAnimHourglassM Medium animated hourglass			



## 8.2.2 Cursor API

The table below lists the available cursor-related routines in alphabetical order. Detailed descriptions follow:

### Functions

Routine	Description
<a href="#">GUI_CURSOR_GetState()</a>	Returns if the cursor is currently visible or not.
<a href="#">GUI_CURSOR_Hide()</a>	Hides the cursor.
<a href="#">GUI_CURSOR_Select()</a>	Sets a specified cursor style.
<a href="#">GUI_CURSOR_SelectAnim()</a>	Sets an animated cursor.
<a href="#">GUI_CURSOR_SetPosition()</a>	Sets the cursor position.
<a href="#">GUI_CURSOR_Show()</a>	Shows the cursor.

### Data structures

Structure	Description
<a href="#">GUI_CURSOR_ANIM</a>	Structure that stores information about a cursor animation used by <a href="#">GUI_CURSOR_SelectAnim()</a> .

## 8.2.2.1 Functions

### 8.2.2.1.1 GUI\_CURSOR\_GetState()

#### Description

Returns if the cursor is currently visible or not.

#### Prototype

```
int GUI_CURSOR_GetState(void);
```

#### Return value

1	if the cursor is visible.
0	if not.

### 8.2.2.1.2 GUI\_CURSOR\_Hide()

#### Description

Hides the cursor.

#### Prototype

```
void GUI_CURSOR_Hide(void);
```

#### Additional information

This is the default cursor setting. If the cursor should be visible, the function `GUI_CURSOR_Show()` needs to be called.

### 8.2.2.1.3 GUI\_CURSOR\_Select()

#### Description

Sets a specified cursor style.

#### Prototype

```
GUI_CURSOR GUI_CURSOR_Select(const GUI_CURSOR * pCursor);
```

#### Parameters

Parameter	Description
<code>pCursor</code>	Pointer to the cursor to be selected.

Permitted values for parameter <code>pCursor</code> (Predefined cursors)	
<code>GUI_CursorArrowS</code>	Small arrow.
<code>GUI_CursorArrowM</code>	Medium arrow.
<code>GUI_CursorArrowL</code>	Large arrow.
<code>GUI_CursorArrowSI</code>	Small inverted arrow.
<code>GUI_CursorArrowMI</code>	Medium inverted arrow.
<code>GUI_CursorArrowLI</code>	Large inverted arrow.
<code>GUI_CursorCrossS</code>	Small cross.
<code>GUI_CursorCrossM</code>	Medium cross.
<code>GUI_CursorCrossL</code>	Large cross.
<code>GUI_CursorCrossSI</code>	Small inverted cross.
<code>GUI_CursorCrossMI</code>	Medium inverted cross.
<code>GUI_CursorCrossLI</code>	Large inverted cross.

#### Additional information

If this function is not called, the default cursor is a medium arrow.

### 8.2.2.1.4 GUI\_CURSOR\_SelectAnim()

#### Description

Sets an animated cursor.

#### Prototype

```
int GUI_CURSOR_SelectAnim(const GUI_CURSOR_ANIM * pCursorAnim);
```

#### Parameters

Parameter	Description
<code>pCursorAnim</code>	Pointer to a GUI_CURSOR_ANIM structure used for the animation.

Permitted values for parameter <code>pCursor</code> (Predefined cursors)	
<code>GUI_CursorAnimHourglassM</code>	Animated hourglass, medium size.

### 8.2.2.1.5 GUI\_CURSOR\_SetPosition()

#### Description

Sets the cursor position.

#### Prototype

```
void GUI_CURSOR_SetPosition(int xNewPos,  
                             int yNewPos);
```

#### Parameters

Parameter	Description
<code>x</code>	X-position of the cursor.
<code>y</code>	Y-position of the cursor.

#### Additional information

Normally this function is called internally by the Window Manager and does not need to be called from the application.

### 8.2.2.1.6 GUI\_CURSOR\_Show()

#### Description

Shows the cursor.

#### Prototype

```
void GUI_CURSOR_Show(void);
```

#### Additional information

The default setting for the cursor is hidden; therefore this function must be called if you want the cursor to be visible.

## 8.2.2.2 Data structures

### 8.2.2.2.1 GUI\_CURSOR\_ANIM

#### Description

Structure that stores information about a cursor animation used by `GUI_CURSOR_SelectAnim()`.

#### Type definition

```
typedef struct {
    const GUI_BITMAP ** ppBm;
    int xHot;
    int yHot;
    unsigned Period;
    const unsigned * pPeriod;
    int NumItems;
} GUI_CURSOR_ANIM;
```

#### Structure members

Member	Description
<code>ppBm</code>	Pointer to an array of pointers to bitmaps to be used for the animated cursor.
<code>xHot</code>	X-position of hot spot. Details can be found below.
<code>yHot</code>	Y-position of hot spot. Details can be found below.
<code>Period</code>	<code>Period</code> to be used to switch between the images.
<code>pPeriod</code>	Pointer to an array containing the periods to be used to switch between the images.
<code>NumItems</code>	Number of images used for the animation.

#### Additional information

The bitmaps addressed by `ppBM` need to fulfill with the following requirements:

- They need to have exactly the same X- and Y-size.
- They should not be compressed.
- They need to be transparent.
- They need to be palette based bitmaps with 1, 2, 4 or 8bpp.

Other bitmaps or insufficient memory cause the function to fail.

The `pPeriod` is only required if the periods for the images are different. If the same period should be used for all images `Period` should be used instead of `pPeriod`. In this case `pPeriod` should be `NULL`.

`xHot` and `yHot` determine the hot spot position of the cursor. This means the relative position in X and Y from the upper left corner of the image to the position of the pointer input device.

Customized cursors can be realized by passing a pointer to a custom defined `GUI_CURSOR_ANIM` structure.



## 8.3 Virtual screens / Virtual pages

A virtual screen means a display area greater than the physical size of the display. It requires additional video memory and allows instantaneous switching between different screens even on slow CPUs. The following chapter shows

- the requirements for using virtual screens,
- how to configure emWin
- and how to take advantage of virtual screens.

If a virtual display area is configured, the visible part of the display can be changed by setting the origin.

### 8.3.1 Introduction

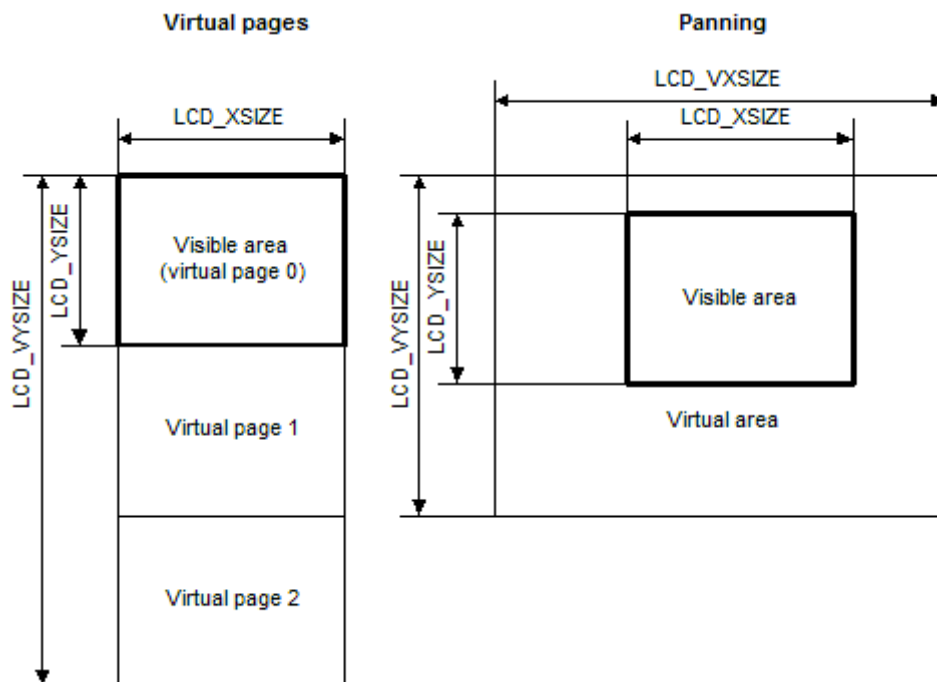

The virtual screen support of emWin can be used for panning or for switching between different video pages.

#### Panning

If the application uses one screen which is larger than the display, the virtual screen API functions can be used to make the desired area visible.

#### Virtual pages

Virtual pages are a way to use the display RAM as multiple pages. If an application for example needs 3 different screens, each screen can use its own page in the display RAM. In this case, the application can draw the second and the third page before they are used. After that the application can switch very fast between the different pages using the virtual screen API functions of emWin. The only thing the functions have to do is setting the right display start address for showing the desired screen. In this case the virtual Y-size typically is a multiple of the display size in Y.

## 8.3.2 Requirements

The virtual screen feature requires hardware with more display RAM than required for a single screen and the ability of the hardware to change the start position of the display output.

### Video RAM

The used display controller should support video RAM for the virtual area. For example if the display has a resolution of 320x240 and a color depth of 16 bits per pixel and 2 screens should be supported, the required size of the video RAM can be calculated as follows:

```
Size = LCD_XSIZE * LCD_YSIZE * LCD_BITSPERPIXEL / 8 * NUM_SCREEN  
Size = 320 * 240 * 16 / 8 * 2  
Size = 307200 Bytes
```

### Configurable display start position

The used display controller needs a configurable display start position. This means the display driver even has a register for setting the frame buffer start address or it has a command to set the upper left display start position.

## 8.3.3 Configuration

Virtual screens should be configured during the initialization. The function `LCD_SetVSize-Ex()` needs to be used to define the virtual display size. Further it is required to react on the command `LCD_X_SETORG` in the driver callback routine by setting the right frame buffer start address.

### 8.3.3.1 LCD\_SetVSizeEx()

#### Description

Sets the size of the virtual display area.

#### Prototype

```
int LCD_SetVSizeEx(int LayerIndex,  
                  int xSize,  
                  int ySize);
```

#### Parameters

Parameter	Description
<a href="#">LayerIndex</a>	Layer index.
<a href="#">xSize</a>	X-Size in pixels of the virtual area of the given layer.
<a href="#">ySize</a>	Y-Size in pixels of the virtual area of the given layer.

#### Return value

0        on success.  
1        on error.

#### Additional information

The function requires a display driver which is able to manage dynamically changes of the virtual display size. If the display driver does not support this feature the function fails.

## 8.3.4 Examples

In the following a few examples are shown to make clear how to use virtual screens with emWin.

### 8.3.4.1 Basic example

The following example shows how to use a virtual screen of 128x192 and a display of 128x64 for instantaneous switching between 3 different screens.

#### Configuration







```
LCD_SetSizeEx (0, 128, 64);
LCD_SetVSizeEx(0, 128, 192);
```

#### Application

```
GUI_SetColor(GUI_RED);
GUI_FillRect(0, 0, 127, 63);
GUI_SetColor(GUI_GREEN);
GUI_FillRect(0, 64, 127, 127);
GUI_SetColor(GUI_BLUE);
GUI_FillRect(0, 128, 127, 191);
GUI_SetColor(GUI_WHITE);
GUI_SetTextMode(GUI_TM_TRANS);
GUI_DispStringAt("Screen 0", 0, 0);
GUI_DispStringAt("Screen 1", 0, 64);
GUI_DispStringAt("Screen 2", 0, 128);
GUI_SetOrg(0, 64); /* Set origin to screen 1 */
GUI_SetOrg(0, 128); /* Set origin to screen 2 */
```

#### Output

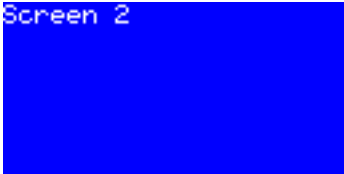
The table below shows the output of the display:

Description	Display output	Contents of virtual area
Before executing GUI_SetOrg(0, 64)		
After executing GUI_SetOrg(0, 64)		
After executing GUI_SetOrg(0, 128)		

### 8.3.4.2 Real time example using the Window Manager

The shipment of emWin contains an example which shows how to use virtual screens in a real time application. It can be found under `Sample\Tutorial\VSCREEN_RealTime.c`:

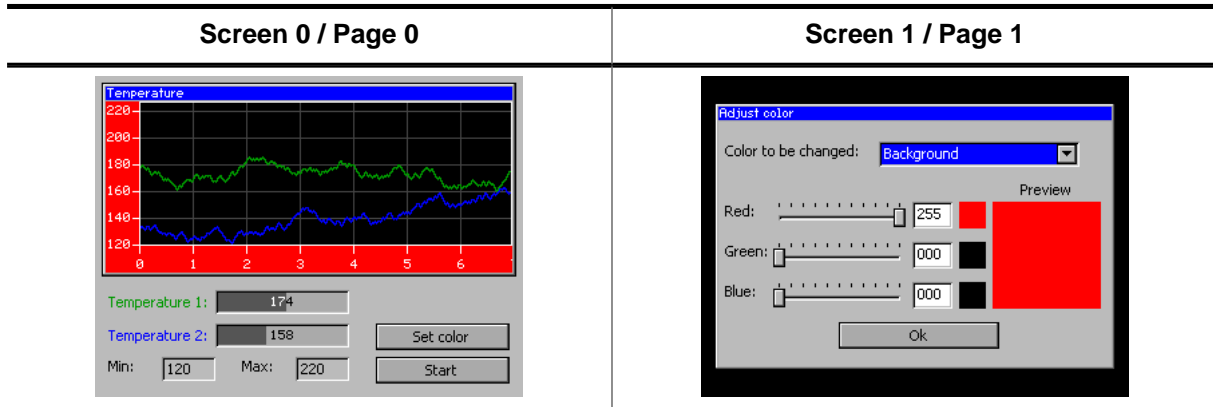

After showing a short introduction, the example creates 2 screens on 2 separate pages as shown above. The first screen shows a dialog which includes a graphical representation of 2 temperature curves. When pressing the "Set color" button, the application switches instantaneously to the second screen, even on slow CPUs. After pressing the "OK" button of the "Adjust color" dialog, the application switches back to the first screen. For more details, see the source code of the example.

#### Viewer Screenshot of the above example

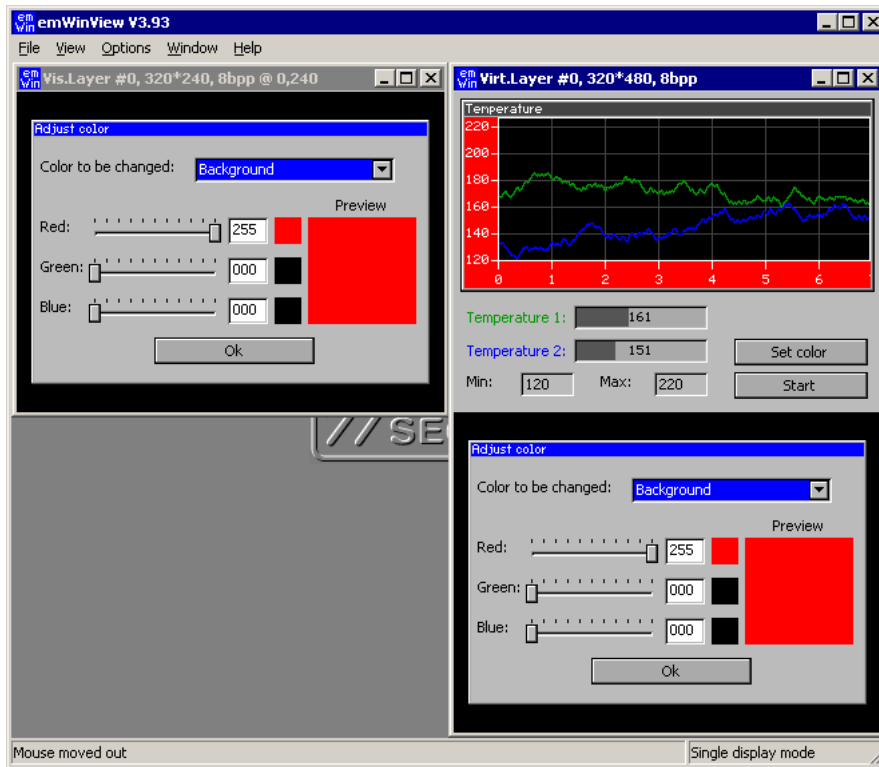

If using the viewer both screens can be shown at the same time. The screenshot above shows the visible display at the left side and the contents of the whole configured virtual display RAM at the right side.

### 8.3.4.3 Dialog example using the Window Manager

The second advanced example is available in the folder Sample/GUI/vSCREEN\_MultiPage. It uses the virtual screen to show 4 screens on 3 different video pages. The application consists of the following screens:

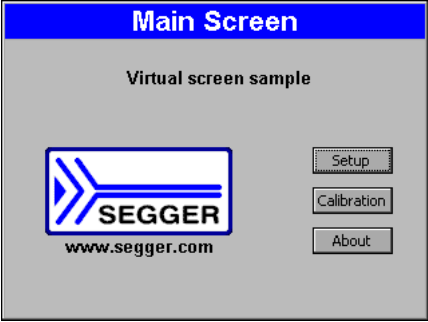
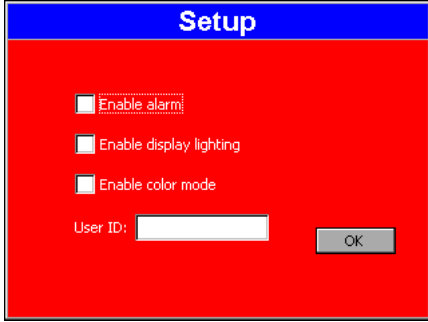
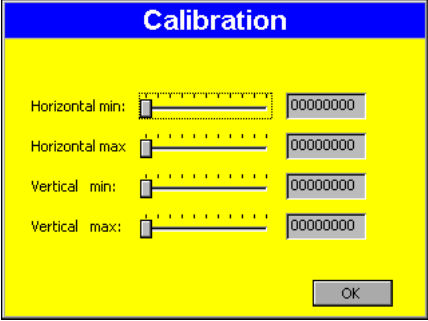
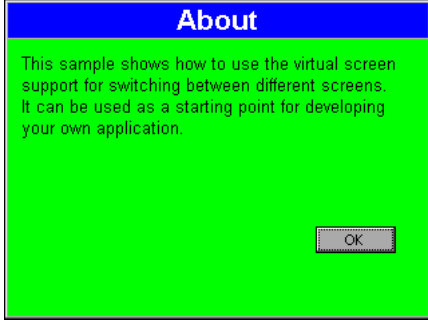
<p style="text-align: center;"><b>Main screen / Page 0</b></p> 	<p style="text-align: center;"><b>Setup screen / Page 1</b></p> 
<p style="text-align: center;"><b>Calibration screen / Page 2</b></p> 	<p style="text-align: center;"><b>About screen / Page 2</b></p> 

After a short intro screen the "Main Screen" is shown on the display using page 0. After the "Setup" button is pressed, the "Setup" screen is created on page 1. After the screen has been created, the application makes the screen visible by switching to page 1. The "Calibration" and the "About" screen both use page 2. If the user presses one of the buttons "Calibration" or "About" the application switches to page 2 and shows the dialog.

#### Viewer Screenshot of the above example

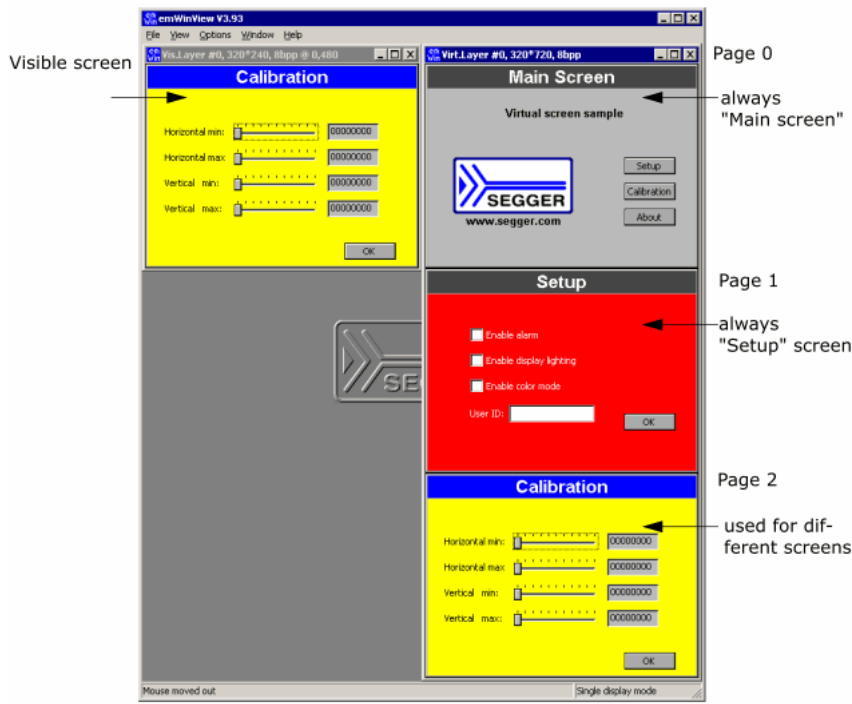

The viewer can show all pages at the same time. The screenshot above shows the visible display at the left side and the contents of the whole layer (virtual display RAM) with the pages 0 - 2 at the right side.

#### 8.3.4.4 Virtual screen API

The following table lists the available routines of the virtual screen support.

Routine	Description
<a href="#">GUI_GetOrg()</a>	Returns the display start position.
<a href="#">GUI_SetOrg()</a>	Sets the display start position.

### 8.3.4.4.1 GUI\_GetOrg()

#### Description

Returns the display start position.

#### Prototype

```
void GUI_GetOrg(int * px,  
               int * py);
```

#### Parameters

Parameter	Description
<code>px</code>	Pointer to variable of type int to store the X position of the display start position.
<code>py</code>	Pointer to variable of type int to store the Y position of the display start position.

#### Additional information

The function stores the current display start position into the variables pointed by the given pointers.



### 8.3.4.4.2 GUI\_SetOrg()

#### Description

Sets the display start position.

#### Prototype

```
void GUI_SetOrg(int x,  
               int y);
```

#### Parameters

Parameter	Description
<a href="#">x</a>	New X position of the display start position.
<a href="#">y</a>	New Y position of the display start position.

# Chapter 9

## Tools

---

The following chapter contains all sub-chapters on the tools supplied with emWin.

- AppWizard
- Viewer
- Bitmap Converter
- Font Converter
- emWinSPY
- emWin4Web
- GUI Builder



## 9.1.1 About the AppWizard

### What is the AppWizard?

The AppWizard is a tool for creating complete and ready-to-use emWin applications. The tool makes it very easy to build an application, manage resources and even define the application's behavior.

### What You See Is What You Get

The AppWizard tool incorporates the idea of **WYSIWYG** (What You See Is What You Get). This means while the user is building their application with the tool, they simultaneously see the output of their build.

To go along with this motto, testing is made very easy, as it just requires a quick press of the F5 key to enter **Play mode**.

### Define the application's behavior

Interactions are a key part of the AppWizard, they make it very easy to define what the application should do on certain events. For example, when clicking a button, the language of the application is changed or an animation is performed and so on.

Conditions and calculations are also powerful tools for defining the application logic and behavior.

### Custom drawings

Additionally to the many widgets that are usable in AppWizard, the user can also define custom drawings which are displayed in the application.

### Resource management

This tool manages application resources entirely by itself. This means the user does not have to fiddle around with any text, font or image files. When adding images to the AppWizard, all of the converting is done automatically.

Font creation and image conversion can be done comfortably within the tool. No external application is required.

The text manager lets the user easily save the application's texts in different languages, which makes building a multilingual application incredibly easy.

In case of a small addressable ROM area, the tool can also outsource all kinds of resources to an SD card. This does not have to apply for all resource files, it can be done individually for each resource file.

### Target system

The AppWizard's output works with any system having at least 130 KBytes of RAM and 256 KBytes of ROM. The tool comes with predefined BSPs for many target boards. Some of them already contain a ready-to-use emFile system properly configured for the according board which makes it possible to outsource resources to SD card without writing any additional line of code. Please note that for commercial use a license is required.

### Output

The AppWizard generates an application as a bundle of C source and header files. If the user wants to debug their application and, perhaps, add custom defined code, the generated application comes with a simulation project.

## 9.2 emWinView

If you use the simulation when debugging your application, you cannot see the display output when stepping through the source code. The primary purpose of emWinView is to solve this problem. It shows the contents of the simulated layer(s) or display(s) while debugging in the simulation.



The viewer gives you the following additional capabilities:

- Each layer is shown separately
- Virtual layer is shown as one combined layer
- Composite view for multi-layer configurations
- Color palettes for indexed layers
- Zooming for each layer
- Selection tool for measurement and copying of areas on the layer
- Pixel grid

## 9.2.1 Installation

### Installation

Before the tool can be used, it has to be installed using the wizard that is located in the emWin shipment folder.

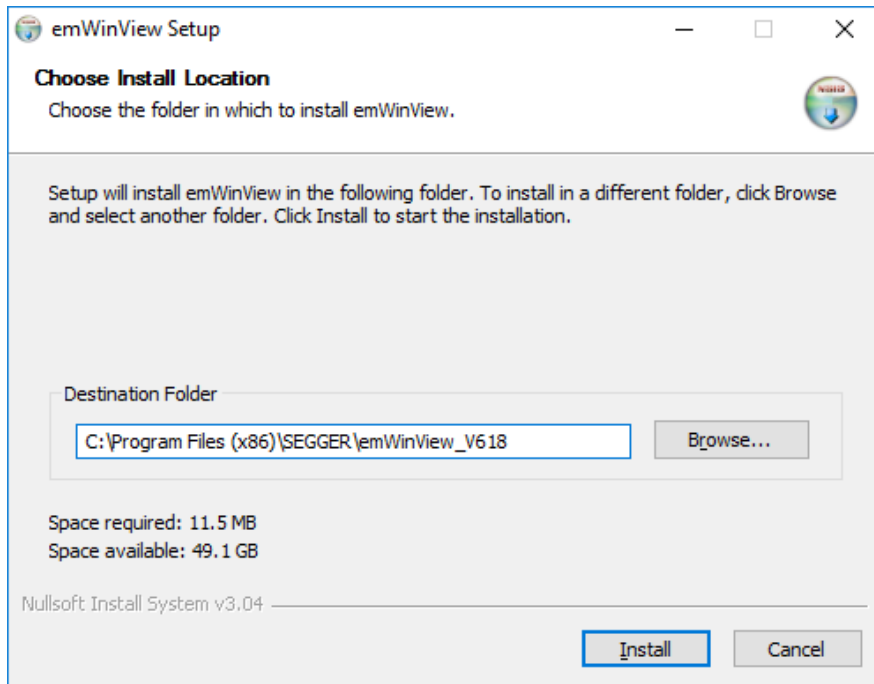

### Uninstallation

To uninstall the tool, simply run the uninstaller located in the installation directory.

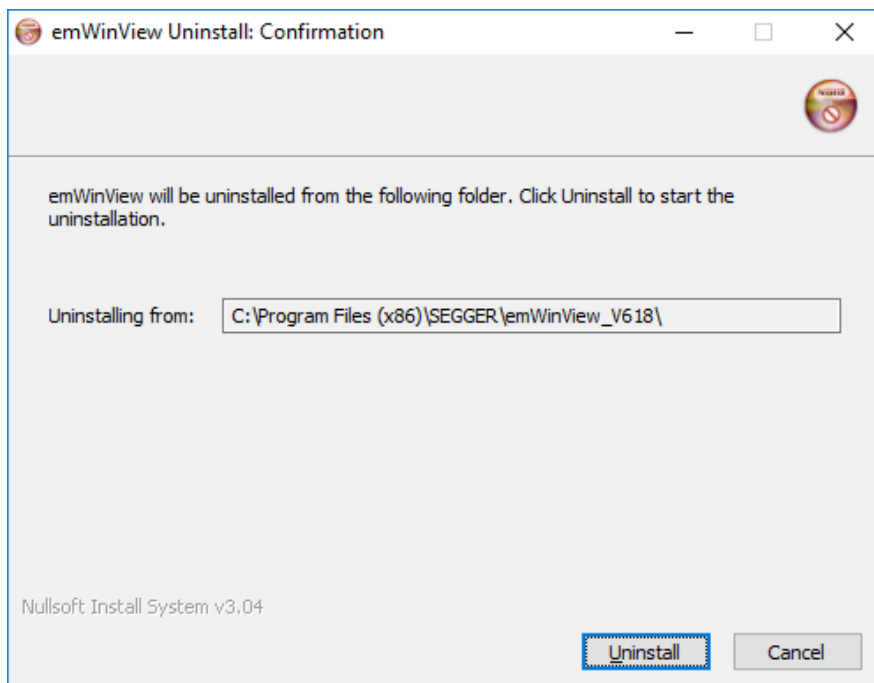

## 9.2.2 Using the simulation and the viewer

If you use the simulation when debugging your application, you cannot see the display output when stepping through the source code. This is due to a limitation of Win32: If one thread (the one being debugged) is halted, all other threads of the process are also halted. This includes the thread which outputs the simulated display on the screen.

The emWin viewer solves this problem by showing the display window and the color window of your simulation in a separate process. It is your choice if you want to start the viewer before debugging your application or while you are debugging. Our suggestion:

- **Step 1:** Start the viewer. No display- or color window is shown until the simulation has been started.
- **Step 2:** Open the Visual Studio workspace.
- **Step 3:** Compile and run the application program.
- **Step 4:** Debug the application as described previously.

The advantage is that you can now follow all drawing operations step by step in the LCD window.

## 9.2.3 Virtual pages

By default the viewer opens one window per layer which shows the visible part of the video RAM, normally the display. If the configured virtual video RAM is larger than the display, the command **View** → **Virtual Layer** → **Layer (0...4)** can be used to show the whole video RAM in one window. When using the function `GUI_SetOrg()`, the contents of the visible screen will change, but the virtual layer window remains unchanged:

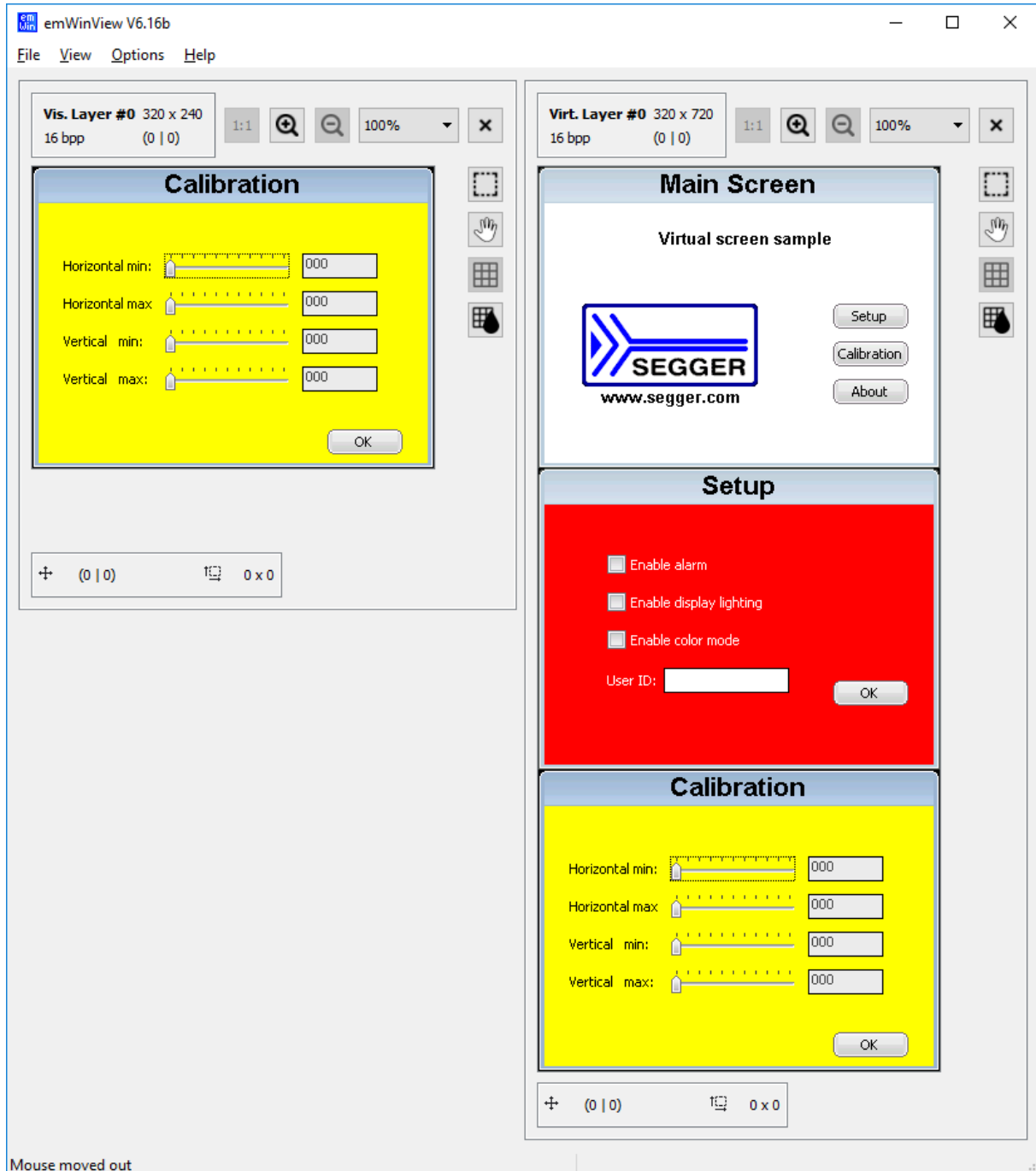

For more information about virtual screens, refer to chapter *Virtual screens / Virtual pages* on page 3089.

## 9.2.4 Multibuffering

If an application uses multiple buffers, the main layer window will always show the front buffer. This means that during debugging, changes to the frame buffer will not be visible until the buffers have been switched.



To see all buffers, the entire video RAM can be opened as a virtual layer. This is done the same way as opening virtual layers, as described above.

## 9.2.5 Multiple displays

If you are working with multiple displays you should set the viewer into 'Multi display mode' by using the command **Options → Multi layer/display... → Multi display mode**.

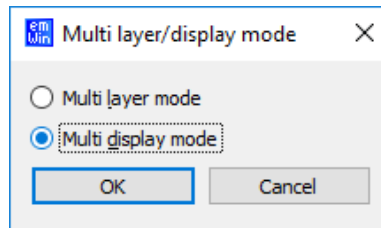

### 9.2.5.1 Multiple layers

If you are working with multiple layers you should set the viewer into 'Multi layer mode' by using the command **Options → Multi layer/display... → Multi layer mode**.

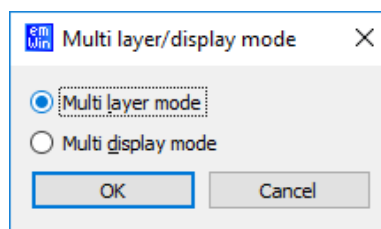

When starting the debugger the viewer will show every single layer and also a composite view of the layers. In order for a composite view to be shown, the composite view has to be enabled by calling `SIM_GUI_SetCompositeSize()` in `SIM_X_Config()`.

### Example

The example below shows a screenshot of the viewer running the "WeatherForecast" demo with two layers configured.

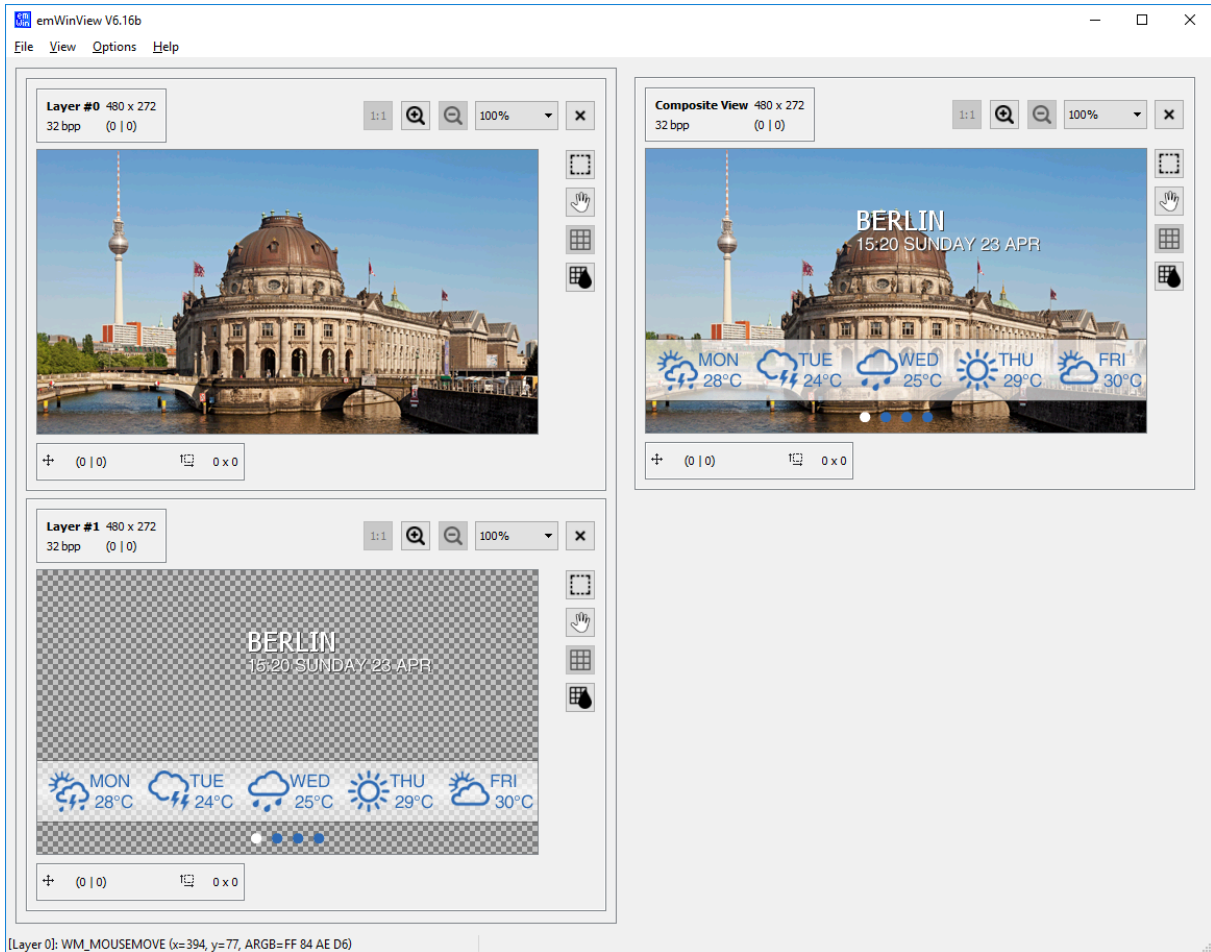

### Transparency

The composite view of the viewer shows all layers; layers with higher index are on top of layers with lower index and can have transparent pixels.

The layer 0 can have transparency, in that case the background color for the composite view is used. This background color can be set using `SIM_GUI_SetCompositeColor()` in `SIM_X_Config()`.

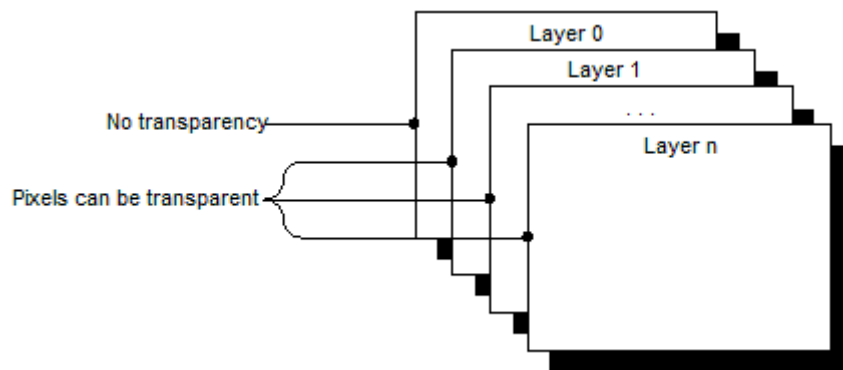

The user can define how transparency should be displayed in emWinView for layers in multi-layer configurations. It can be a gray checkerboard pattern (as seen above) or a custom defined color.

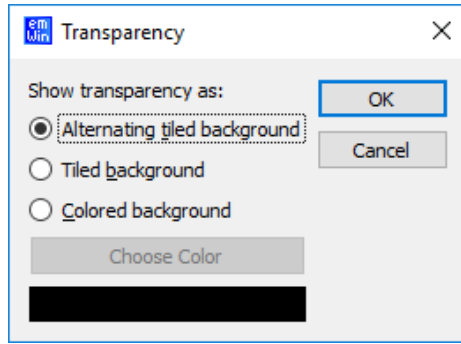

### 9.2.6 Palette-based layers

When the viewer is started, any palette-based layers will automatically show their palette next to them.

The currently selected palette color can also be shown highlighted, this can be read below under *Highlight palette colors* on page 3111.

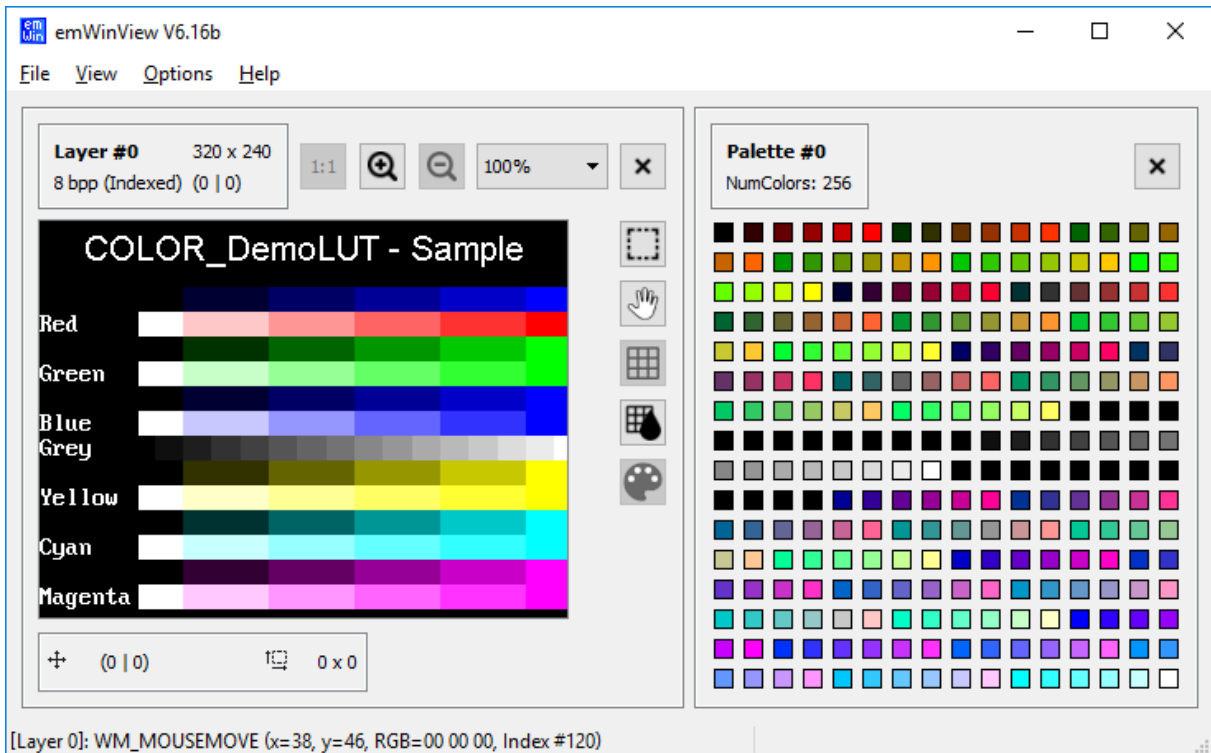

## 9.2.7 Tools

### 9.2.7.1 Selection Tool

 The selection tool can be used to select an area in a layer. This area can be copied to the clipboard by right-clicking the selection.

By default, the selection is highlighted, as shown below. This can be disabled by clicking **Options** → **Highlight selection**.

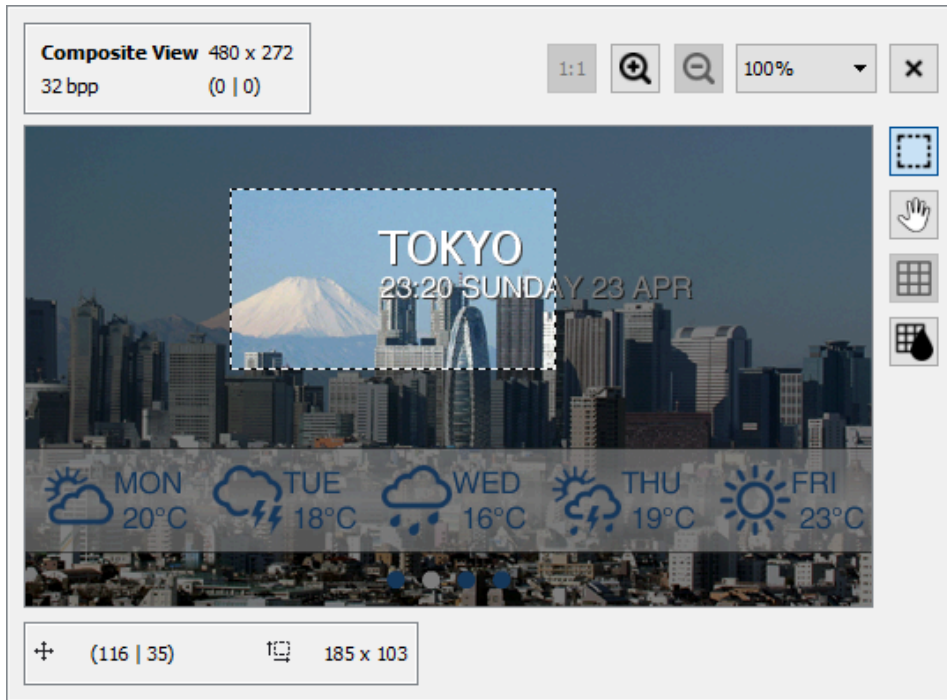

The tool can also be used to measure a distance in a layer. The size and top-left position of the selection rectangle is shown below the layer.

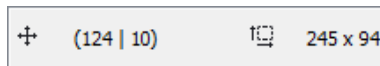

Right-clicking on the selection info below the layer view allows editing of the position and size of the selection rectangle. This can be useful, when the selection should be prepared for copying a specific region of the layer.

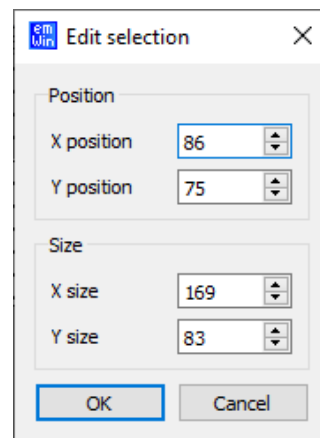
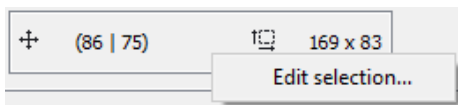

### 9.2.7.2 Hand Tool

 The hand tool allows scrolling through a zoomed layer by clicking and dragging instead of using the mouse wheel.

### 9.2.7.3 Zooming

A layer can be magnified using the zooming tools above the layer. The + and - buttons increase/decrease the zooming level by one.



Increases the zoom level.



Decreases the zoom level.



Resets the zoom level to 100%.

The dropdown allows the selection of a specific zoom level.

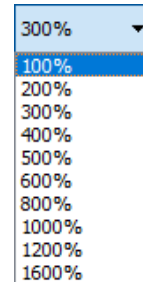
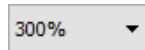

### 9.2.7.4 Grid



The grid can be toggled by clicking the button right to the layer.

This can be done once the zooming level is at 300% or above.



The button below allows the selection of a color for the grid. The selected color is specific to the layer.

Under **Options** → **Grid color...** a default grid color can be selected.

#### XOR grid

Instead of a specific color, the grid can also be drawn inverted to the underlying pixel color (XOR mode). This can be useful when a grid with a single color is not visible due to parts of the layer having the same color.

A XOR grid is always visible, because the color below the grid is inverted. The only exception would be the color 7F7F7F, since inverting this color will result in the same color.



## 9.2.8 Options

### 9.2.8.1 Always on top

Per default the viewer window is always on top. You can change this behavior by selecting **Options → Always on top** from the menu.

### 9.2.8.2 Highlight palette colors

When this feature is enabled, hovering over a palette-based layer will show the color in the palette as highlighted. You can enable this by selecting **Options → Highlight palette colors**.

## 9.2.9 Copy to clipboard

### Copy layer image

The contents of a layer or composite view can be copied to the clipboard by right-clicking the layer/view and selecting **Copy to clipboard**.

When a selection has been made and **Copy to clipboard** is clicked, the selected part of the layer will be copied to clipboard.

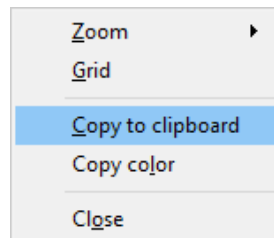

Pressing **CTRL + C** also copies the selected image to clipboard.

### Copy color

When a pixel in a layer is right clicked, selecting **Copy color** will copy the color as an ARGB value to clipboard.

Color and index values of palette colors can also be copied to clipboard.

## 9.2.10 Closing and opening layers

 Layers can be closed by clicking the **X** button in the upper right corner.

They can also be opened and closed via the **View** menu.

## 9.3 Bitmap Converter

The Bitmap Converter is designed for converting common image file formats like BMP, PNG, JPEG or GIF into the desired emWin bitmap format. That can be a C file which can directly be compiled and linked with the project or a binary format, which can be loaded at runtime. Simply load an image into the application. Convert the color format if you want or have to, and save it in the appropriate format.

### Screenshot of the Bitmap Converter



### 9.3.1 What it does

The Bitmap Converter is primarily intended as a tool to convert bitmaps from a PC format to a C file. Bitmaps which can be used with emWin are normally defined as `GUI_BITMAP` structures in C. The structures — or rather the picture data which is referenced by these structures — can be quite large. It makes therefore sense to use the Bitmap Converter to generate C files from bitmaps.

Another useful feature is the ability to save images as C stream files. The advantage against a normal C file is, that these data streams can be located anywhere on any media whereas C files need to be located in the addressable ROM area.

The Bitmap Converter also features color conversion, so that the resulting C code is not unnecessarily large. Typically the number of bits per pixel are reduced to achieve less memory consumption. The tool displays the converted image as well.

A number of simple functions can be performed with the Bitmap Converter, including scaling the size, flipping the bitmap horizontally or vertically, rotating it, and inverting the bitmap indices or colors (these features can be found under the `Image` menu). Any further modifications to an image must be made in a bitmap manipulation program such as Adobe Photoshop or Corel Photopaint. It usually makes the most sense to perform any image modifications in such a program, using the Bitmap Converter for converting purposes only.



## 9.3.2 Loading a bitmap

### 9.3.2.1 Supported input file formats

The Bitmap Converter supports the following file types:

- Windows bitmap files (\* .bmp)
- Graphic Interchange Format (\* .gif)
- Portable Network Graphics (\* .png)
- Joint Photographic Experts Group format (\* .jpeg)
- C bitmaps (\* .c \* .cc \* .cpp \* .cxx \* .h \* .hh \* .hpp \* .hxx)
- Streamed bitmaps (\* .dta)

#### Windows Bitmap Files (BMP)

The Bitmap Converter supports the most common bitmap file formats. Bitmap files of the following formats can be opened by the Bitmap Converter:

- 1, 4 or 8 bits per pixel (bpp) with palette
- 16, 24 or 32 bpp without palette (full-color mode, in which each color is assigned an RGB value)
- RLE4 and RLE8

Trying to read bitmap files of other formats will cause an error message of the Bitmap Converter.

#### Graphic Interchange Format (GIF)

The Bitmap Converter supports reading GIF files. For general editing only the first image of the GIF file is used. GIF image consisting of several images may be converted to animated sprites, animated cursors or emWin movie files.

Transparency and interlaced GIF images are supported by the converter.

**Note:** Compressed/optimized GIFs are not supported, the Bitmap Converter will not decompress the GIF frames. These GIFs must first be manually decompressed (aka. "un-optimized") with tools like GIMP.

#### Portable Network Graphic (PNG)

The PNG format is the most recommended format to create images with alpha blending. The Bitmap Converter supports reading PNG images with alpha channel.

#### Joint Photographic Experts Group (JPEG)

The JPEG format is the most common used format when dealing with photos. JPEG files using a lossy compression method. Because of that they are not the ideal format for diagrams or similar.

The Bitmap Converter supports reading JPEG images.

#### C bitmaps and streamed bitmaps (C and DTA)

The Bitmap Converter supports reading of previously converted bitmaps in both the C and the DTA format.

Despite animated sprites and cursors being also saved as a C file, it is not possible to load these into the Bitmap Converter.

Any file with a C/C++ file extension, whether they are header or source files, are interpreted as C bitmap files.

### 9.3.2.2 Loading from a file

An image file of one of the supported formats may be opened directly in the Bitmap Converter by selecting **File → Open**.

### 9.3.2.3 Using the clipboard

Any other type of bitmap (that is, .jpg, .jpeg, .tif) may be opened with another program, copied to the clipboard, and pasted into the Bitmap Converter. This process will achieve the same effect as loading directly from a file.

### 9.3.3 Color conversion

The primary reason for converting the color format of a bitmap is to reduce memory consumption. The most common way of doing this is by using the option **Best palette** as in the above example, which customizes the palette of a particular bitmap to include only the colors which are used in the image. It is especially useful with full-color bitmaps in order to make the palette as small as possible while still fully supporting the image. Once a bitmap file has been opened in the Bitmap Converter, simply select **Image → Convert Into → Best palette** from the menu. If it is necessary to keep transparency select **Image → Convert Into → Best palette + transparency**.

For certain applications, it may be more efficient to use a fixed color palette, chosen from the menu under **Image → Convert Into**. For example, suppose a bitmap in full-color mode is to be shown on a display which supports only four grayscales. It would be a waste of memory to keep the image in the original format, since it would only appear as four grayscales on the display. The full-color bitmap can be converted into a four-grayscale, 2bpp bitmap for maximum efficiency.

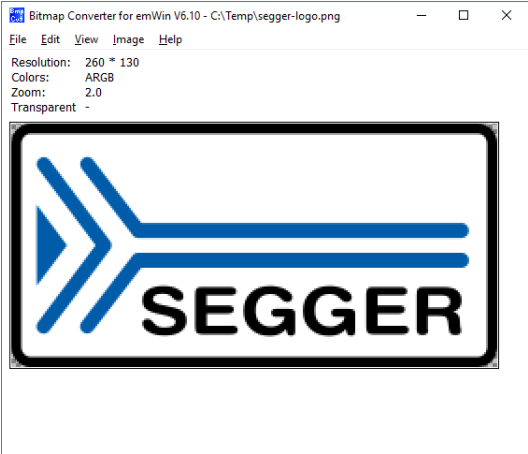
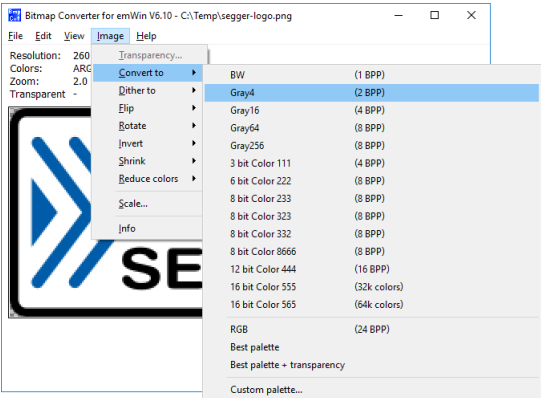
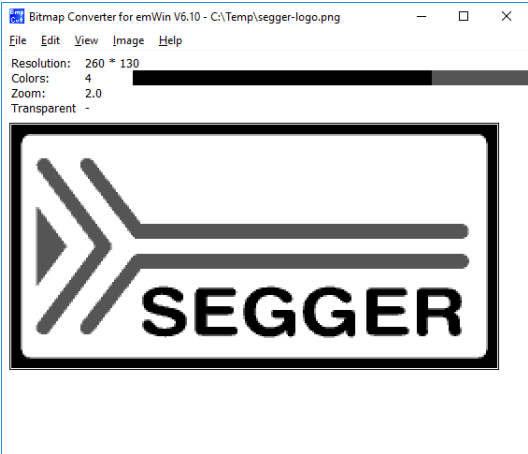

The procedure for conversion would be as follows:

Step	Result
<p><b>Step 1: Load the image</b></p> <ul style="list-style-type: none"> <li>The Bitmap Converter is opened and the same file is loaded as in steps 1 and 2 of the example shown in <i>Saving the file</i> on page 3120.</li> <li>The Bitmap Converter displays the loaded bitmap.</li> </ul>	
<p><b>Step 2: Convert the image</b></p> <ul style="list-style-type: none"> <li>Choose <b>Image → Convert Into → Gray4</b></li> </ul>  <ul style="list-style-type: none"> <li>The Bitmap Converter displays the converted bitmap.</li> </ul>	 <ul style="list-style-type: none"> <li>In this example, the image uses less memory since a palette of only 4 grayscales is used instead of the full-color mode. If the target display supports only 4 grayscales, there is no use in having a higher pixel depth as it would only waste memory.</li> </ul>

Step	Result
------	--------

### 9.3.4 Dithering

Dithering is a method for showing more details on systems with only a few available colors than with a simple color conversion. It gives the illusion of a better color depth by using noise to randomize quantization error. If for example a photo needs to be drawn on a b/w system normally not much details would be visible after a simple conversion. However, dithering is able to show much more details:

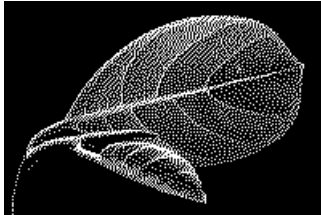
Original	black / white	black / white, dithered
		

The above table shows clearly the difference between dithering and a simple conversion. To dither a picture the command **Image → Dither to → ...** should be used:

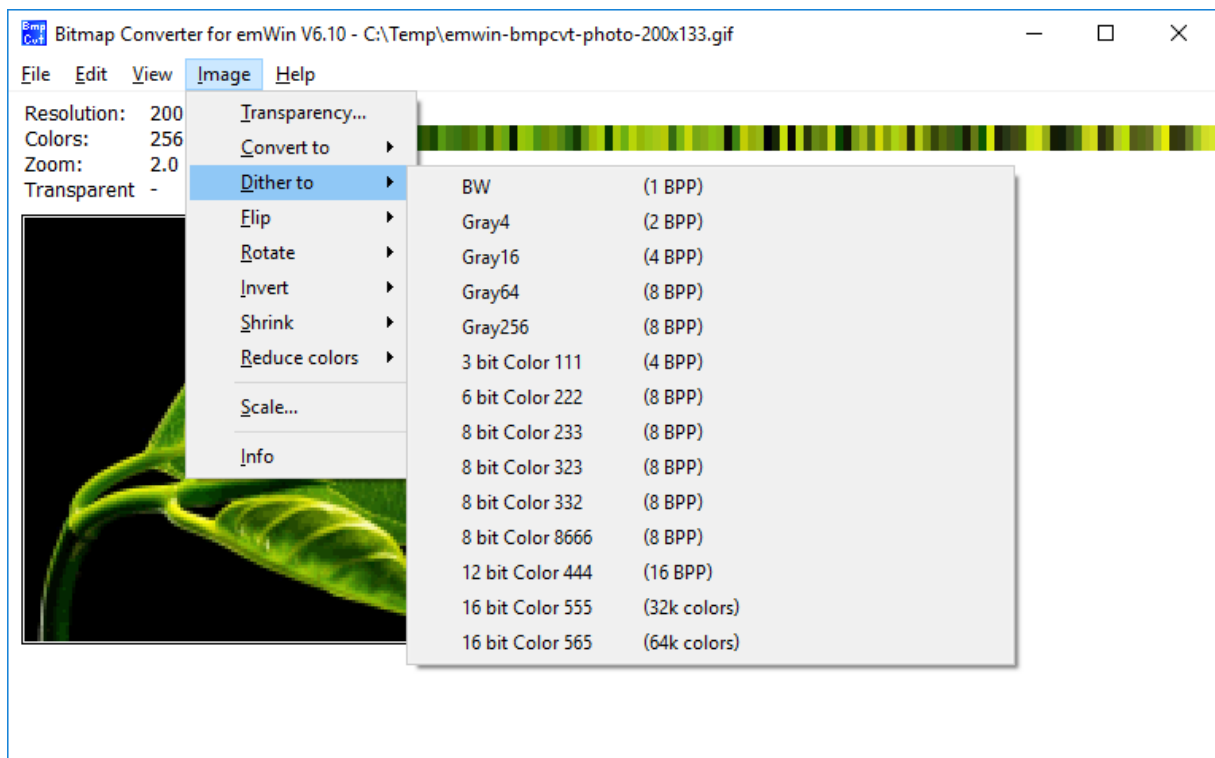

### 9.3.5 Using a custom palette

Converting bitmaps to a custom palette and saving them without palette information can save memory and can increase the performance of bitmap drawing operations.

#### More efficient memory utilization

Per default each bitmap contains its own palette. Even the smallest bitmaps can contain a large palette with up to 256 colors. In many cases only a small fraction of the palette is used by the bitmap. If using many of these bitmaps the amount of memory used by the palettes can grow rapidly.

So it can save much ROM if converting the bitmaps used by emWin to the available hardware palette and saving them as (D)evice (D)ependent (B)itmaps without palette information.

### Better bitmap drawing performance

Before emWin draws a bitmap, it needs to convert each device independent bitmap palette to the available hardware palette. This is required because the pixel indices of the bitmap file are indices into the device independent bitmap palette and not to the available hardware palette. Converting the bitmap to a DDB means that color conversion at run time is not required and speeds up the drawing.

#### 9.3.5.1 Saving a palette file

The Bitmap Converter can save the palette of the currently loaded bitmap into a palette file which can be used for converting other bitmaps with the command **Image → Convert Into → Custom palette**. This requires that the current file is a palette based file and not a RGB file. To save the palette the command **File → Save palette...** can be used.

#### 9.3.5.2 Palette file format

Custom palette files are simple files defining the available colors for conversion. They contain the following:

- Header (8 bytes)
- NumColors (U32, 4 bytes)
- 0 (4 bytes)
- U32 Colors[NumColors] (NumColors \* 4 bytes, type GUI\_COLOR)

Total file size is therefore:  $16 + (\text{NumColors} * 4)$  bytes. A custom palette file with 8 colors would be  $16 + (8 * 4) = 48$  bytes. At this point, a binary editor must be used in order to create such a file.

The maximum number of colors supported is 256; the minimum is 2.

#### Example

This example file would define a palette containing 2 colors—red and white:

```
0000: 65 6d 57 69 6e 50 61 6c 02 00 00 00 00 00 00
0010: ff 00 00 00 ff ff ff 00
```

The 8 headers make up the first eight bytes of the first line. The U32 is stored lsb first (big endian) and represents the next four bytes, followed by the four 0 bytes. Colors are stored 1 byte per color, where the 4th byte is 0 as follows: RRGGBB00. The second line of code defines the two colors used in this example.

#### 9.3.5.3 Palette files for fixed palette modes

Using the custom palette feature can even make sense with the most common used fixed palette modes, not only with custom hardware palettes. For the most palette based fixed palette modes a palette file can be found in the folder `Sample\Palette`.

#### 9.3.5.4 Converting a bitmap

The command **Image → Convert Into → Custom palette** should be used for converting the currently loaded bitmap to a custom palette. The Bitmap Converter tries to find the nearest color of the palette file for each pixel of the currently loaded bitmap.

### 9.3.6 Generating C files from bitmaps

The main function of the Bitmap Converter is to convert PC-formatted bitmaps into C files which can be used by emWin. Before doing so, however, it is often desirable to modify the color palette of an image so that the generated C file is not excessively large.

The bitmap may be saved as a bmp, png or a gif file (which can be reloaded and used or loaded into other bitmap manipulation programs) or as a C file. A C file will serve as an input file for your C compiler. It may contain a palette (device-independent bitmap, or DIB) or be saved without (device-dependent bitmap, or DDB). DIBs are recommended, as they will display correctly on any display; a DDB will only display correctly on a display which uses the same palette as the bitmap.

C files may be generated as "C with palette", "C without palette", "C with palette, compressed" or "C without palette, compressed". For more information on compressed files, see the section "Compressed bitmaps" as well as the example at the end of the chapter.

### 9.3.6.1 Supported bitmap formats

The following table shows the currently available output formats for C and C stream files:

Format	Color depth [bpp]	Com-pression	Trans-parency	Palette
1 bit per pixel	1	no	yes	yes
2 bits per pixel	2	no	yes	yes
4 bits per pixel	4	no	yes	yes
8 bits per pixel	8	no	yes	yes
Compressed, RLE1	1	yes	yes	yes
Compressed, RLE4	4	yes	yes	yes
Compressed, RLE8	8	yes	yes	yes
12 bits per pixel 444_12	12	no	no	no
12 bits per pixel M444_12, red and blue swapped	12	no	no	no
12 bits per pixel 444_12_1	12	no	no	no
12 bits per pixel M444_12_1, red and blue swapped	12	no	no	no
12 bits per pixel 444_16	12	no	no	no
12 bits per pixel M444_16, red and blue swapped	12	no	no	no
High color 555	15	no	no	no
High color 555, red and blue swapped	15	no	no	no
High color 565	16	no	no	no
High color 565, red and blue swapped	16	no	no	no
High color 565, compressed	16	yes	no	no
High color 565, red and blue swapped, compressed	16	yes	no	no
High color A555 with alpha channel	15	no	yes	no
High color AM555 with alpha channel, red and blue swapped	15	no	yes	no
High color A565 with alpha channel	16	no	yes	no
High color AM565 with alpha channel, red and blue swapped	16	no	yes	no
True color 888	24	no	no	no
True color 8888 with alpha channel	32	no	yes	no
True color 8888 with alpha channel, compressed	32	yes	yes	no
True color M8888I with alpha channel, red and blue swapped, alpha inverted	32	no	yes	no
Alpha channel	8	no	yes	no
Alpha channel, compressed	8	yes	yes	no

### 9.3.6.2 Palette information

A bitmap palette is an array of 24 bit RGB color entries. Bitmaps with a color depth from 1 - 8 bpp can be saved with (device independent bitmap, DIB) or without palette information (device dependent bitmap DDB).

#### Device independent bitmaps (DIB)

The color information is stored in the form of an index into the color array. Before emWin draws a DIB, it converts the 24 bit RGB colors of the bitmap palette into color indices of the hardware palette. The advantage of using DIBs is that they are hardware independent and can be drawn correctly on systems with different color configurations. The disadvantages are the additional ROM requirement for the palette and the slower performance because of the color conversion.

#### Device dependent bitmaps (DDB)

The pixel information of a DDB is the index of the displays hardware palette. No conversion needs to be done before drawing a DDB. The advantages are less ROM requirement and a better performance. The disadvantage is that these bitmaps can not be displayed correctly on systems with other color configurations.

### 9.3.6.3 Transparency

A palette based bitmap can be converted to a transparent bitmap. Transparency means each pixel with index 0 will not produce any output. The command **Image → Transparency** can be used to select the color which should be used for transparency. After selecting the transparent color, the pixel indices of the image will be recalculated, so that the selected color is on position 0 of the bitmap palette. When saving the bitmap file as C file, it will be saved with the transparency attribute.

### 9.3.6.4 Alpha blending

Alpha blending is a method of combining an image with the background to create the effect of semi transparency. The alpha value of a pixel determines its transparency. The color of a pixel after drawing the bitmap is a blend of the former color and the color value in the bitmap. In emWin, logical colors are handled as 32 bit values. The lower 24 bits are used for the color information and the upper 8 bits are used to manage the alpha value. An alpha value of 0 means the image is opaque and a value of 0xFF means completely transparent. Whereas BMP and GIF files do not support alpha blending PNG files support alpha blending. So the easiest way to create bitmap files with alpha blending is to load a PNG file. When working with BMP and/or GIF files the Bitmap Converter initially has no information about the alpha values.

#### Loading a PNG file

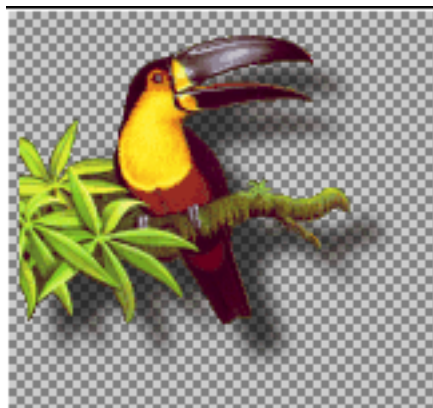

This is the most recommended way for creating bitmaps with an alpha mask:



The PNG file contains all required information.

### Loading the alpha values from an alpha mask bitmap

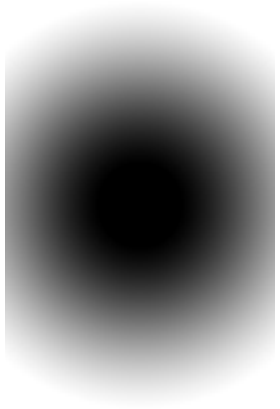



This method loads the alpha values from a separate file. Black pixels of the alpha mask file means opaque and white means transparent. The following table shows an example:

Starting point	Alpha mask	Result
		

The command **File → Load Alpha Mask** can be used for loading an alpha mask.

### Creating the alpha values from two bitmaps

This method uses the difference between the pixels of two pictures to calculate the alpha values. The first image should show the item on a black background. The second image should show the same on a white background. The following table shows an example of how to create the alpha values using the command **File → Create Alpha**:

Starting point	Black background	White background	Result
			

The command **File → Create Alpha** can be used for creating the alpha values.

### 9.3.6.5 Selecting the best format

emWin supports various formats for the generated C file. It depends on several conditions which will be the 'best' format and there is no general rule to be used. Color depth, compression, palette and transparency affect the drawing performance and/or ROM requirement of the bitmap.

#### Color depth

In general the lower the color depth the smaller the ROM requirement of the bitmap. Each display driver has been optimized for drawing 1bpp bitmaps (text) and bitmaps with the same color depth as the display.

### Compression

The supported RLE compression method has the best effect on bitmaps with many horizontal sequences of equal-colored pixels. Details later in this chapter. The performance is typically slightly slower than drawing uncompressed bitmaps.

### Palette

The ROM requirement of a palette is 4 bytes for each color. So a palette of 256 colors uses 1 KB. Furthermore emWin needs to convert the colors of the palette before drawing the bitmap. Advantage: Bitmaps are device independent meaning they can be displayed on any display, independent of its color depth and format.

### Transparency

The ROM requirement of transparent bitmaps is the same as without transparency. The performance is with transparency slightly slower than without.

### High color and true color bitmaps

Special consideration is required for bitmaps in these formats. Generally the use of these formats only make sense on displays with a color depth of 15 bits and above. Further it is strongly recommended to save the C files in the exact same format used by the hardware. Note that using the right format will have a positive effect on the drawing performance. If a high color bitmap for example should be shown on a system with a color depth of 16bpp which has the red and blue components swapped, the best format is 'High color 565, red and blue swapped'. Already a slightly other format has the effect, that each pixel needs color conversion, whereas a bitmap in the right format can be rendered very fast without color conversion. The difference of drawing performance in this case can be factor 10 and more.

## 9.3.6.6 Saving the file

The basic procedure for using the Bitmap Converter is illustrated below:

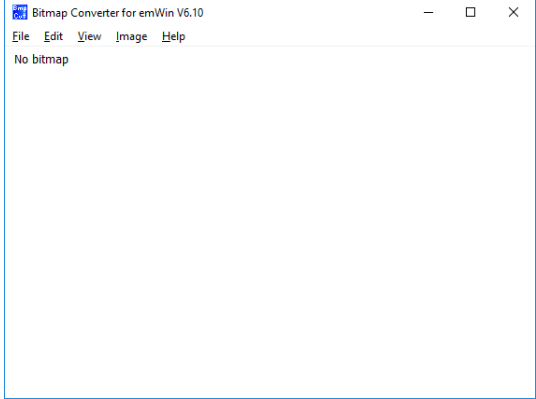
Step	Result
<p><b>Step 1: Start the application.</b></p> <ul style="list-style-type: none"> <li>The Bitmap Converter is opened showing an empty window.</li> </ul>	

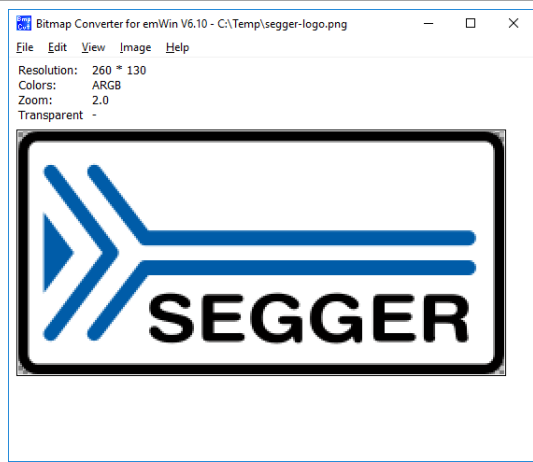
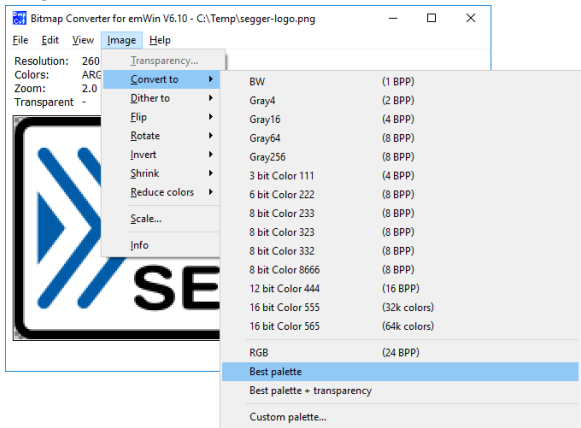
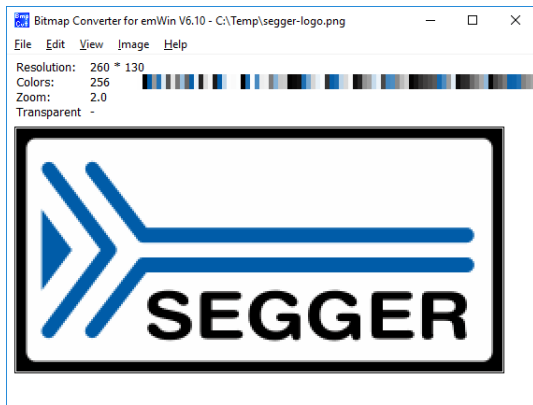
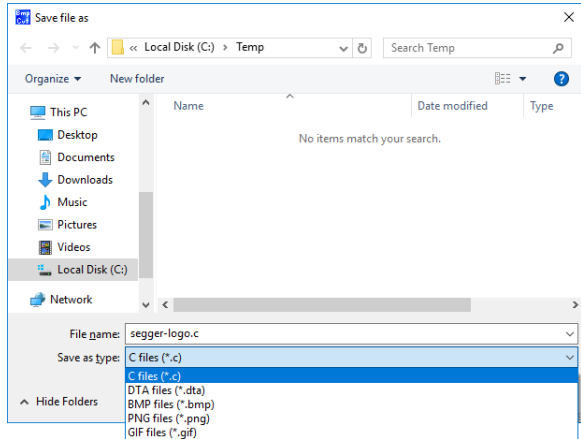

Step	Result
<p><b>Step 2: Load a bitmap into the Bitmap Converter.</b></p> <ul style="list-style-type: none"> <li>Choose <b>File → Open</b></li> <li>Locate the document you want to open and click <b>Open</b>. The Bitmap Converter can open images of the bmp, gif, png and sbmp format.</li> </ul>  <ul style="list-style-type: none"> <li>The Bitmap Converter displays the loaded bitmap.</li> </ul>	
<p><b>Step 3: Choose conversion</b></p>  <ul style="list-style-type: none"> <li>Choose <b>Image → Convert Into</b></li> <li>Select the desired palette. In this example, the option Best palette is chosen.</li> <li>The Bitmap Converter displays the converted bitmap.</li> </ul>	 <ul style="list-style-type: none"> <li>The image is unchanged in terms of appearance, but uses less memory since a palette of only 15 colors is used instead of the full-color mode. These 15 colors are the only ones actually required to display this particular image.</li> </ul>
<p><b>Step 4: Save the bitmap as a C file.</b></p> <ul style="list-style-type: none"> <li>Choose <b>File → Save As</b>.</li> <li>Select a destination and a name for the C file.</li> <li>Select the file type. In this example, the file is saved as C bitmap file.</li> <li>Click <b>Save</b>.</li> </ul>	

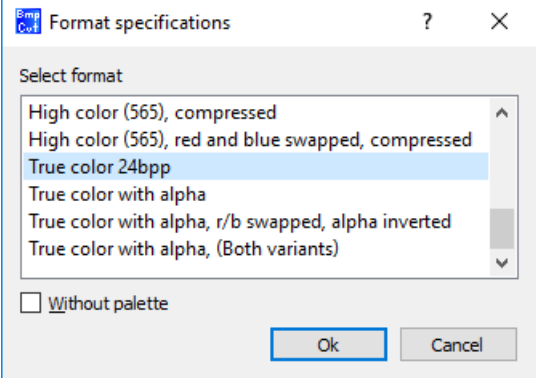
Step	Result
<p><b>Step 5: Specify bitmap format.</b></p> <ul style="list-style-type: none"> <li>If the bitmap should be saved as C file the format should now be specified. Use one of the available formats shown in the dialog. If the bitmap should be saved without palette, activate the check box <b>Without palette</b>.</li> <li>The Bitmap Converter will create a separate file in the specified destination, containing the C source code for the bitmap.</li> </ul>	

### 9.3.7 Generating C stream files

A C stream file consists of the same information as a C file. Contrary to a C file a data stream can be located anywhere and does not need to be compiled or linked with the project. All supported output formats described for C files are also available for C stream files. emWin supports creating bitmaps from data streams and drawing data streams directly. Detailed information about C stream file support can be found under *Drawing streamed bitmaps* on page 365.

```

(all values LSB):
Header (16 Bytes)
  2 Bytes Id (0x42, 0x4d, "BM")
  16 Bits Format (FORMAT_1BPP      - 1
                 FORMAT_2BPP      - 2
                 FORMAT_4BPP      - 4
                 FORMAT_8BPP      - 5
                 FORMAT_RLE1      - 32
                 FORMAT_RLE4      - 6
                 FORMAT_RLE8      - 7
                 FORMAT_565       - 8
                 FORMAT_M565      - 9
                 FORMAT_555       - 10
                 FORMAT_M555      - 11
                 FORMAT_RLE16     - 12
                 FORMAT_RLEM16    - 13
                 FORMAT_8888      - 16
                 FORMAT_RLE32     - 15
                 FORMAT_24        - 17
                 FORMAT_RLEALPHA  - 18
                 FORMAT_444_12    - 19
                 FORMAT_M444_12   - 20
                 FORMAT_444_12_1 - 21
                 FORMAT_M444_12_1 - 22
                 FORMAT_444_16    - 23
                 FORMAT_M444_16   - 24
                 FORMAT_A555      - 25
                 FORMAT_AM555     - 26
                 FORMAT_A565     - 27
                 FORMAT_AM565     - 28
                 FORMAT_M8888I    - 29)

  16 Bits xSize
  16 Bits ySize
  16 Bits BytesPerLine
  16 Bits BitsPerPixel
  16 Bits NumEntries (Number of colors in palette based bitmaps)
  16 Bits HasTrans (1 if transparency exists, 0 if not)
Palette data (4 bytes per entry)
  for each entry:
    if ("Save colors in ARGB" == 0):
      8 Bits Red
      8 Bits Green
      8 Bits Blue
      8 Bits Alpha
    if ("Save colors in ARGB" == 1):
      8 Bits Blue
      8 Bits Red
      8 Bits Green
      8 Bits Alpha
  // Pixel order is from left to right and from top to bottom
Pixel data (FORMAT_1BPP, FORMAT_2BPP, FORMAT_4BPP, FORMAT_8BPP):
  for each line:
    for each pixel:
      1-8 Bits per pixel index value
Pixel data (FORMAT_RLE1):
  MSB:   Color index
  7 Bits: Number of pixels
Pixel data (FORMAT_RLE4):
  8 Bit Counter
  if (Counter > 0):
    8 Bits index value into palette (Counter: number of pixels of same color)
    // Lower nibble used only
  if (Counter == 0):
    8 Bits number of pixels (1 or 2)
    8 Bits Index values into palette (Pixel 1: upper nibble, Pixel 2: lower
nibble)
    // If (HasTrans == 1) and (Index == 0) pixel is transparent

```

```

Pixel data (FORMAT_RLE8):
  8 Bit Counter
  if (Counter > 0):
    8 Bits index value into palette (Counter: number of pixels of same color)
  if (Counter == 0):
    8 Bits number of pixels (1 or 2)
    for each pixel:
      8 Bits Index value into palette
      // If (HasTrans == 1) and (Index == 0) pixel is transparent
Pixel data (FORMAT_RLEALPHA):
  8 Bit Counter
  if (Counter > 0):
    8 Bits Intensity (Counter: number of pixels of same intensity)
  if (Counter == 0):
    8 Bits number of pixels (1 or 2)
    for each pixel:
      8 Bits Intensity (Counter: number of pixels of same intensity)
Pixel data (FORMAT_RLE16, FORMAT_RLE16):
  8 Bit Counter
  if (Counter > 0):
    16 Bits color index value (Counter: number of pixels of same color)
  if (Counter == 0):
    8 Bits number of pixels (1 or 2)
    for each pixel:
      16 Bits color index value
Pixel data (FORMAT_RLE32):
  8 Bit Counter
  if (Counter > 0):
    32 Bits color value (Counter: number of pixels of same color)
  if (Counter == 0):
    8 Bits number of pixels (1 or 2)
    for each pixel:
      32 Bits color index value
Pixel data (FORMAT_565, FORMAT_M565, FORMAT_555, FORMAT_M555):
  for each line:
    for each pixel:
      16 Bits color index
Pixel data (FORMAT_8888, FORMAT_M8888I):
  for each line:
    for each pixel:
      32 Bits color value
Pixel data (FORMAT_24):
  for each line:
    for each pixel:
      8 Bits Red
      8 Bits Green
      8 Bits Blue
Pixel data (FORMAT_444_12, FORMAT_M444_12, FORMAT_444_12_1,
          FORMAT_M444_12_1, FORMAT_444_16, FORMAT_M444_16):
  for each line:
    for each pixel:
      16 Bits color index (12 Bits used only, dependent on format)
Pixel data (FORMAT_A555, FORMAT_AM555, FORMAT_A565, FORMAT_AM565):
  for each line:
    for each pixel:
      16 Bits color index (15 Bits color, 1 bit alpha, dependent on format)

```

### 9.3.8 Compressed bitmaps

The Bitmap Converter and emWin support run-length encoding (RLE) compression of bitmaps in the resulting source code files. The RLE compression method works most efficiently if your bitmap contains many horizontal sequences of equal-colored pixels. An efficiently compressed bitmap will save a significant amount of space. However, compression is not recommended for photographic or dithered images since they do not normally have sequences of identical pixels. It should also be noted that a compressed image may take slightly longer to display.

Storing a bitmap using RLE compression can be done by selecting one of the according output formats when saving as a C file: "C with palette, compressed" or "C without palette, compressed". There are no special functions needed for displaying compressed bitmaps; they are displayed the same way uncompressed bitmaps are displayed.

### Compression ratios

The ratio of compression achieved will vary depending on the bitmap used. The more horizontal uniformity in the image, the better the ratio will be. A higher number of bits per pixel will also result in a higher degree of compression.

In the bitmap used in the previous examples, the total number of pixels in the image is  $(200 * 94) = 18,800$ .

Since 2 pixels are stored in 1 byte, the total uncompressed size of the image is  $18,800 / 2 = 9,400$  bytes.

The total compressed size for this particular bitmap is 3,803 bytes for 18,800 pixels (see the example at the end of the chapter).

The ratio of compression can therefore be calculated as  $9,400 / 3,803 = 2.47$ .

## 9.3.9 Creating animated sprites / cursors

The Bitmap Converter can be used to convert animated GIF files to animated sprites / cursors in C file format. This functionality is offered by the entries in the file menu which are shown below:

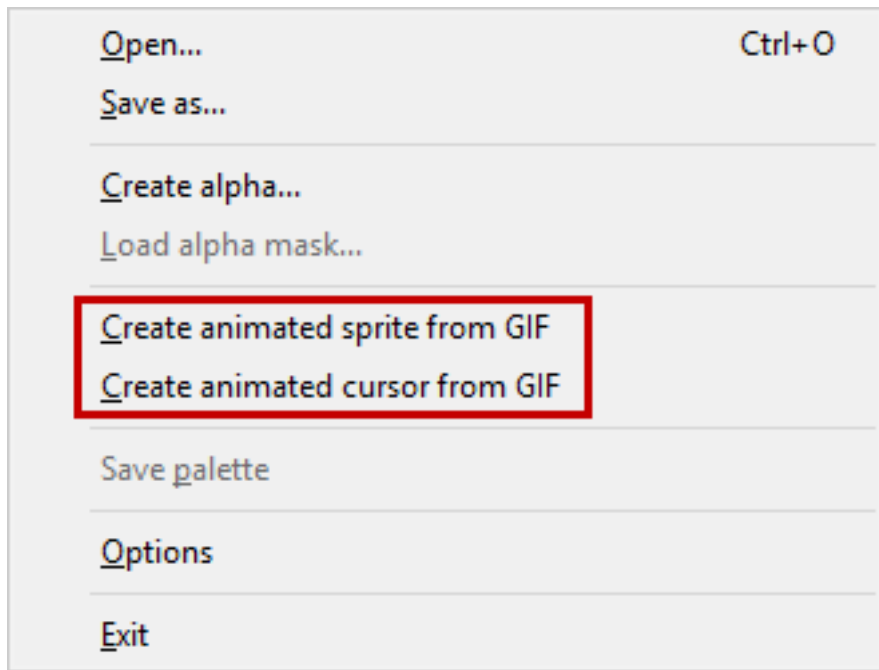

After clicking one of the according file menu entries, a file dialog appears and an animated GIF file can be chosen. Once this is done the name of the resulting C file needs to be specified. Converting animated GIF files to animated sprites / cursors does not require any further parameters. The process is performed automatically. Since the effort depends on the input GIF file, completing this task may take a moment. The Bitmap Converter can be used again as soon as the mouse cursor is changed to the simple arrow again.

### 9.3.9.1 Animated Sprite example

The following shows the structure of an animated sprite C file as it is generated by the Bitmap Converter. Although animations consist of several images, the palette and pixel data structures are shown only once here. Variable data is described using place holders.

## File header

```

/*****
 *          (c) 1998 - 2020 Segger Microcontroller GmbH          *
 *          Solutions for real time microcontroller applications  *
 *          www.segger.com                                       *
 *****/
 *
 * C-file generated by                                          *
 *
 *          Bitmap Converter for emWin V6.14.                   *
 *          Compiled Aug 27 2020, 16:57:05                      *
 *
 *          (c) 1998 - 2020 Segger Microcontroller GmbH          *
 *
 *****/
 *
 * Source file: %_FILENAME%.gif (Animated Sprite)              *
 * Dimensions:  %_X_SIZE% * %_Y_SIZE%                          *
 * NumImages:   %_NUMBER_OF_IMAGES%                            *
 * Duration:    %_OVERALL_DURATION%                            *
 * NumBytes:    %_NUMBER_OF_BYTES%                              *
 *
 *****/
 *
 * Usage:
 *   %_USAGE_EXAMPLE%
 */

#include <stdlib.h>
#include "GUI.h"
#ifdef GUI_CONST_STORAGE
    #define GUI_CONST_STORAGE const
#endif

```

## Palette and pixel data

```

static GUI_CONST_STORAGE GUI_COLOR%_FILENAME%%_INDEX%[] = {
    %_COLOR_DATA%
};

static GUI_CONST_STORAGE GUI_LOGPALETTE _Pal%_FILENAME%%_INDEX% = {
    %_NUMBER_OF_COLORS%, // Number of entries
    %_TRANSPARENCY_FLAG%, // No transparency
    &Colors%_FILENAME%%_INDEX%[0]
};

static GUI_CONST_STORAGE unsigned char _ac%_FILENAME%%_INDEX%[] = {
    %_PIXEL_DATA%
};

```

## General data

```

static GUI_CONST_STORAGE GUI_BITMAP _abm%_FILENAME%[] = {
    { %_X_SIZE%, %_Y_SIZE%,
      %_BYTES_PER_LINE%, %_BITS_PER_PIXEL%,
      _ac%_FILENAME%%_INDEX%, &Pal%_FILENAME%%_INDEX%
    },
    [...]
};

const GUI_BITMAP * apbm%_FILENAME%[] = {
    &_abm%_FILENAME%[0],
    [...]
};

```

```
const unsigned aDelay%_FILENAME_%[] = {
    %_DELAY_DATA_%
};

/***** End of file *****/
```

### 9.3.9.2 Animated Cursor example

The file structure for animated cursors almost equals the structure for animated sprites. Therefore only the differences are mentioned here. The array of bitmap pointers is defined as static:

```
static const GUI_BITMAP * _apbm%_FILENAME_%[] = {
    [...]
};
```

The array of delays is defined as static:

```
static const unsigned _aDelay%_FILENAME_%[] = {
    [...]
};
```

A non-static definition of a GUI\_CURSOR\_ANIM structure is placed at the end:

```
const GUI_CURSOR_ANIM Cursor%_FILENAME_% = {
    _apbm%_FILENAME_%, // Pointer to an array of bitmaps
    0, // x coordinate of the hot spot
    0, // y coordinate of the hot spot
    0, // Period, should be 0 here
    _aDelay%_FILENAME_%, // Pointer to an array of periods
    %_NUMBER_OF_IMAGES_% // Number of images
};
```

### 9.3.9.3 Additional information

The hot spot coordinate define the position which is recognized by emWin when PID events occur. If the hot spot should not be represented by the topmost leftmost pixel, the according values in the GUI\_CURSOR\_ANIM structure may be modified.

The array of delays is always created. In case every image uses the same delay, the forth value in the GUI\_CURSOR\_ANIM structure may be set accordingly. In this case the array of delays may be deleted after the fifth value of the GUI\_CURSOR\_ANIM structure was set to NULL.

### 9.3.10 Converting GIFs into Bitmap-EMFs

#### About Bitmap-EMFs

General information about the Bitmap-EMF format can be read in the "Movies" chapter under *Bitmap-EMF files* on page 786.

#### Generating a Bitmap-EMF using the Bitmap Converter

GIF animations can be converted into bitmap-based EMFs using the Bitmap Converter. Below is a step-by-step guide on how to generate EMF files from GIF animations.

1. Open Bitmap Converter.
2. Click **File** → **Create emWin movie file from GIF**.

Create emWin movie file from GIF

3. Select GIF file for conversion.

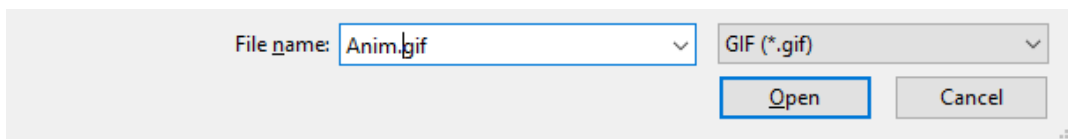

4. Select bitmap format to be used for each frame.

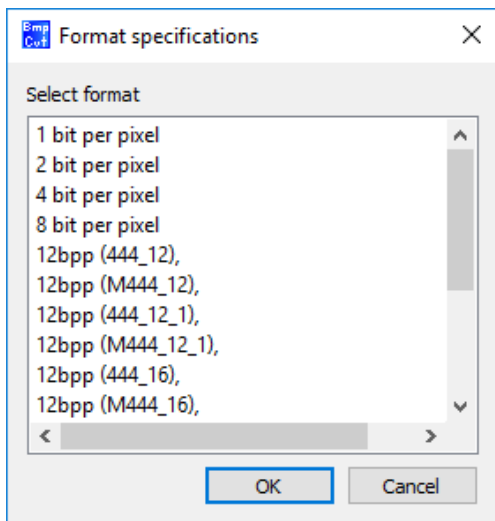

5. Select color format to be used for each frame. The frames can be either dithered or converted into the desired color format.

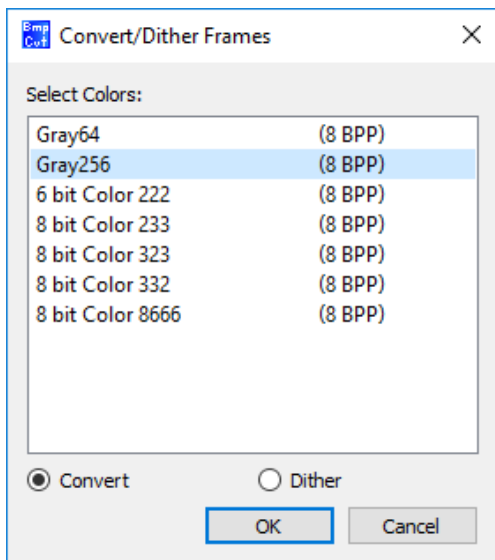



## 6. Save EMF file.

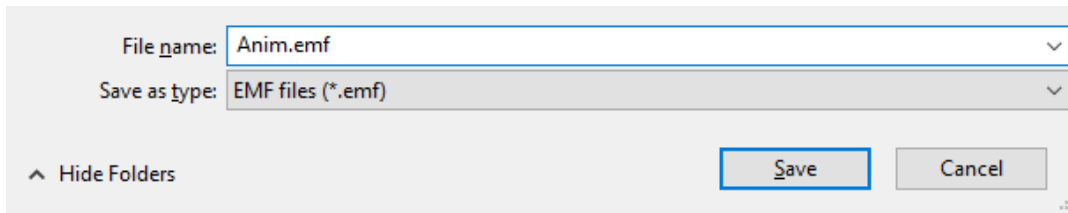

### Color format dialog

This dialog will be prompted when the desired format is 16bpp or lower. The listed color formats are dependent on the previously selected bitmap format. For example, when selecting the 8bpp format, all available color formats for 8bpp are available for conversion, as shown above in step 5.

### Playing a movie

The "Movies" chapter provides detailed information about how bitmap-EMFs can be displayed using emWin. An example can be found under *Bitmap-EMF files* on page 786.

### 9.3.11 Memory footprint

The memory footprint of any exported files is shown in the lower left corner of the Bitmap Converter. The byte count of an exported C bitmap, cursor or sprite is a sum of the number of bytes needed for all structures, palettes and pixel data.

Memory footprint of last saved file: 144,885 bytes

For C bitmaps, sprites and animated cursors, the amount of bytes is also written into the header.

### 9.3.12 Command line usage

It is also possible to work with the Bitmap Converter using the command prompt. All conversion functions available in the Bitmap Converter menu are available as commands, and any number of functions may be performed on a bitmap in one command line.

#### 9.3.12.1 Format for commands

Commands are entered using the following format:

```
BmpCvt <filename>.bmp <-command>
```

If more than one command is used, one space is typed between each. For example, a bitmap with the name logo.bmp is converted into Best palette format and saved as a C file named logo.bmp all at once by entering the following at the command prompt:

```
BmpCvt logo.bmp -convertintobestpalette -saveaslogo,1 -exit
```

Note that while the file to be loaded into the Bitmap Converter always includes its bmp extension, no file extension is written in the `-saveas` command. An integer is used instead to specify the desired file type. The number 1 in the `-saveas` command above designates "C with palette". The `-exit` command automatically closes the program upon completion. See the table below for more information.

#### 9.3.12.2 Command line options

The following table lists all permitted Bitmap Converter commands. It can also be viewed at any time by entering `BmpCvt -?` at the command prompt.

Command	Description
General commands	
<code>-exit</code>	Terminate PC program automatically.
<code>-hide</code>	Hides the application window.
<code>-saveas&lt;file-name&gt;, &lt;type&gt;[ , &lt;fmt&gt;][ , &lt;noplt&gt;]</code>	Save file as filename.
<code>&lt;filename&gt;</code>	User-specified file name including the file extension.
<code>&lt;type&gt;</code>	Must be an integer from 1 to 4 as follows: 1: C with palette (.c file) 2: Windows Bitmap file (bmp file) 3: C stream (.dta file) 4: GIF format (gif file)
<code>&lt;fmt&gt;</code>	Specifies the bitmap format (only if type = 1): 1: 1 bit per pixel* 2: 2 bits per pixel* 4: 4 bits per pixel* 5: 8 bits per pixel* 32: RLE1 compression*

Command	Description
	6: RLE4 compression* 7: RLE8 compression* 8: High color 565 9: High color 565, red and blue swapped 10: High color 555 11: High color 555, red and blue swapped 12: RLE16 compression 13: RLE16 compression, red and blue swapped 15: True color 32bpp, compressed 16: True color 32bpp 17: True color 24bpp 18: Alpha channel 8bpp, compressed 19: 16bpp (444_12) 20: 16bpp (444_12), RB swapped 21: 16bpp (444_12_1) 22: 16bpp (444_12_1), RB swapped 23: 16bpp (444_16) 24: 16bpp (444_16), RB swapped 25: High color (A555) with alpha channel 26: High color (AM555) with alpha channel, red and blue swapped 27: High color (A565) with alpha channel 28: High color (AM565) with alpha channel, red and blue swapped 29: True color 32bpp, red and blue swapped, alpha inverted If this parameter is not given, the Bitmap Converter uses the following default formats in dependence of the number of colors of the bitmap: Number of colors ≤ 2: 1 bit per pixel Number of colors ≤ 4: 2 bits per pixel Number of colors ≤ 16: 4 bits per pixel Number of colors ≤ 256: 8 bits per pixel RGB: High color 565
<noplt>	Saves the bitmap with or without palette (only if type = 1) 0: Save bitmap with palette (default) 1: Save bitmap without palette
Conversion commands	
<code>-convertintobw</code>	Convert image to BW.
<code>-convertintogray4</code>	Convert image to Gray4.
<code>-convertintogray16</code>	Convert image to Gray16.
<code>-convertintogray64</code>	Convert image to Gray64.
<code>-convertintogray256</code>	Convert image to Gray256.
<code>-convertinto111</code>	Convert image to 111.
<code>-convertinto222</code>	Convert image to 222.
<code>-convertinto233</code>	Convert image to 233.
<code>-convertinto323</code>	Convert image to 323.
<code>-convertinto332</code>	Convert image to 332.
<code>-convertinto8666</code>	Convert image to 8666.
<code>-convertintorgb</code>	Convert image to RGB.
<code>-convertintobestpalette</code>	Convert image to best palette.
<code>-convertintotranspalette</code>	Convert image to best palette with transparency.

Command	Description
<code>-convertintocustompalette&lt;filename&gt;</code>	Convert image to a custom palette using the provided palette file.
<b>Dithering commands</b>	
<code>-ditherintobw</code>	Dither image to BW.
<code>-ditherintogray4</code>	Dither image to Gray4.
<code>-ditherintogray16</code>	Dither image to Gray16.
<code>-ditherintogray64</code>	Dither image to Gray64.
<code>-ditherintogray256</code>	Dither image to Gray256.
<code>-ditherinto111</code>	Dither image to 111.
<code>-ditherinto222</code>	Dither image to 222.
<code>-ditherinto233</code>	Dither image to 233.
<code>-ditherinto323</code>	Dither image to 323.
<code>-ditherinto332</code>	Dither image to 332.
<code>-ditherinto8666</code>	Dither image to 8666.
<b>Other commands</b>	
<code>-ARGB</code>	Save colors in ARGB mode.
<code>-ABGR</code>	Save colors in ABGR mode.
<code>-fliph</code>	Flip image horizontally.
<code>-flipv</code>	Flip image vertically.
<code>-invertindices</code>	Invert indices.
<code>-invertpalette</code>	Invert palette entries.
<code>-reducecolors4</code>	Reduce colors to 4.
<code>-reducecolors16</code>	Reduce colors to 16.
<code>-reducecolors256</code>	Reduce colors to 256.
<code>-rotate90cw</code>	Rotate image by 90 degrees clockwise.
<code>-rotate90ccw</code>	Rotate image by 90 degrees counterclockwise.
<code>-rotate180</code>	Rotate image by 180 degrees.
<code>-scale&lt;width&gt;,&lt;height&gt;</code>	Scale image to the given width and height (in percent).
<code>-transparency&lt;color&gt;</code>	Sets the transparent color to the given RGB color.
<b>Command line help</b>	
<code>-help</code>	Displays the command line table.
<code>-?</code>	Displays the command line table.

**Note**

- \* Images need to be converted to an according format before they can be stored in a format of 8 or less bpp.

### 9.3.13 Options

The Bitmap Converter offers you three more options when converting and saving a bitmap file. When clicking on the 'Options' entry in the menu bar an options dialog will pop up. The following table will explain the available options:

Option	Description
Preserve transparency	If checked this option allows to convert an image, containing transparent pixels, in a palette based format and preserve the transparency. If not checked the transparency gets lost.
Big endian mode	This option is only useful if an image gets stored as a DTA file. With the C files the compiler takes care of the endianness but for binary files it is necessary to have them available with the proper byte order.
Save colors in ARGB	This option makes sure to save the colors of a palette as 32bit value where the alpha channel is inverted and the red and blue channels are swapped.

### 9.3.14 Example of a converted bitmap

A typical example for the use of the Bitmap Converter would be the conversion of your company logo into a C bitmap. Take another look at the example bitmap pictured below:



The bitmap is loaded into the Bitmap Converter, converted to `Best palette`, and saved as "C with palette". The resulting C source code is displayed below (some data is not shown to conserve space).

#### Resulting C code (generated by the Bitmap Converter)

```

/*****
 *          (c) 1998 - 2020 Segger Microcontroller GmbH          *
 *      Solutions for real time microcontroller applications      *
 *                      www.segger.com                          *
 *****/
 *
 * C-file generated by
 *
 *      Bitmap Converter for emWin V6.14.
 *      Compiled Aug 27 2020, 16:57:05
 *
 *      (c) 1998 - 2020 Segger Microcontroller GmbH
 *
 *****/
 *
 * Source file: SeggerLogo200
 * Dimensions: 200 * 100
 * NumColors: 256
 * NumBytes: 20164
 *
 *****/
 */

#include <stdlib.h>
#include "GUI.h"
#ifndef GUI_CONST_STORAGE
#define GUI_CONST_STORAGE const
#endif

extern GUI_CONST_STORAGE GUI_BITMAP bmSeggerLogo200;

```

```

static GUI_CONST_STORAGE GUI_COLOR _ColorsSeggerLogo200[] = {
#if (GUI_USE_ARGB == 0)
    0x00FFFFFF, 0x00353537, 0x009C4B37, 0x00CDCDCD,
    [...]
#else
    0x00FFFFFF, 0x00373535, 0x00374B9C, 0x00CDCDCD,
    [...]
#endif
};

static GUI_CONST_STORAGE GUI_LOGPALETTE _PalSeggerLogo200 = {
    33, // Number of entries
    0, // No transparency
    (const LCD_COLOR *)&_ColorsSeggerLogo200[0]
};

static GUI_CONST_STORAGE unsigned char _acSeggerLogo200[] = {
    0x00, 0x00, // Not all data is shown in this example.
    0x00, 0x92,
    [...],
    0xC6, 0x22,
    0x0A, 0x22
};

GUI_CONST_STORAGE GUI_BITMAP bmSeggerLogo200 = {
    200, // xSize
    100, // ySize
    200, // BytesPerLine
    8, // BitsPerPixel
    _acSeggerLogo200, // Pointer to picture data (indices)
    &_PalSeggerLogo200 // Pointer to palette
};

/***** End of file *****/

```

## Compressing the file

We can use the same bitmap image to create a compressed C file, which is done simply by loading and converting the bitmap as before, and saving it as "C with palette, compressed". The source code is displayed below (some data is not shown to conserve space). The compressed image size can be seen towards the end of the file as 3,730 bytes for 18,800 pixels.

## Resulting compressed C code (generated by the Bitmap Converter)

```

/*****
 *          (c) 1998 - 2020 Segger Microcontroller GmbH          *
 *          Solutions for real time microcontroller applications *
 *                               www.segger.com                  *
 *****/
 *
 * C-file generated by
 *
 *          Bitmap Converter for emWin V6.14.
 *          Compiled Aug 27 2020, 16:57:05
 *
 *          (c) 1998 - 2020 Segger Microcontroller GmbH
 *
 *****/
 *
 * Source file: SeggerLogo200
 * Dimensions: 200 * 100
 * NumColors: 256
 * NumBytes: 3894
 *

```

```

*****
*/

#include <stdlib.h>
#include "GUI.h"
#ifndef GUI_CONST_STORAGE
    #define GUI_CONST_STORAGE const
#endif

extern GUI_CONST_STORAGE GUI_BITMAP bmSeggerLogo200_comp;

static GUI_CONST_STORAGE GUI_COLOR _ColorsSeggerLogo200_comp[] = {
#if (GUI_USE_ARGB == 0)
    0x00FFFFFF, 0x00353537, 0x009C4B37, 0x00CDCDCD,
    [...]
#else
    0x00FFFFFF, 0x00373535, 0x00374B9C, 0x00CDCDCD,
    [...]
#endif
};

static GUI_CONST_STORAGE GUI_LOGPALETTE _PalSeggerLogo200_comp = {
    33, // Number of entries
    0, // No transparency
    (const LCD_COLOR *)&_ColorsSeggerLogo200_comp[0]
};

static GUI_CONST_STORAGE unsigned char _acSeggerLogo200_comp[] = {
    /* RLE: 006 Pixels @ 000,000 */ 6, 0x00,
    /* RLE: 188 Pixels @ 006,000 */ 188, 0x01,
    [...],
    /* RLE: 188 Pixels @ 006,099 */ 188, 0x01,
    /* RLE: 006 Pixels @ 194,099 */ 6, 0x00,
    0
}; // 3730 bytes for 20000 pixels

GUI_CONST_STORAGE GUI_BITMAP bmSeggerLogo200_comp = {
    200, // xSize
    100, // ySize
    200, // BytesPerLine
    GUI_COMPRESS_RLE8, // BitsPerPixel
    _acSeggerLogo200_comp, // Pointer to picture data (indices)
    &_PalSeggerLogo200_comp, // Pointer to palette
    GUI_DRAW_RLE8
};

/***** End of file *****/

```

# 9.4 Font Converter

The Font Converter is a tool which allows convenient converting of TrueType and BDF based fonts into an emWin (bitmap) font which can be easily integrated into emWin based applications.

## emWin font formats

emWin fonts are defined either as GUI\_FONT structures in C files or as binary files in the format of System Independent Fonts (SIF) or External Bitmap Fonts (XBF).

## Purchasing

The Font Converter is not part of the emWin Basic package. The full version has to be purchased separately. The emWin basic package comes with the demo version of the Font Converter which provides full functionality and accurate storage of pixel data. However, the demo version's license only allows usage for non-commercial purposes.

## Font licenses

Any used fonts may be protected by copyright or any other intellectual property right of their legal owner.

The Font Converter does not come with any fonts, nor any permission or license to use any font for converting purposes. It is the user's sole responsibility to not infringe upon any third-party intellectual property rights by making use of the fonts in their application. The user must obtain a license for the font if the legal owner requires it.

## Screenshot of the Font Converter with a loaded font

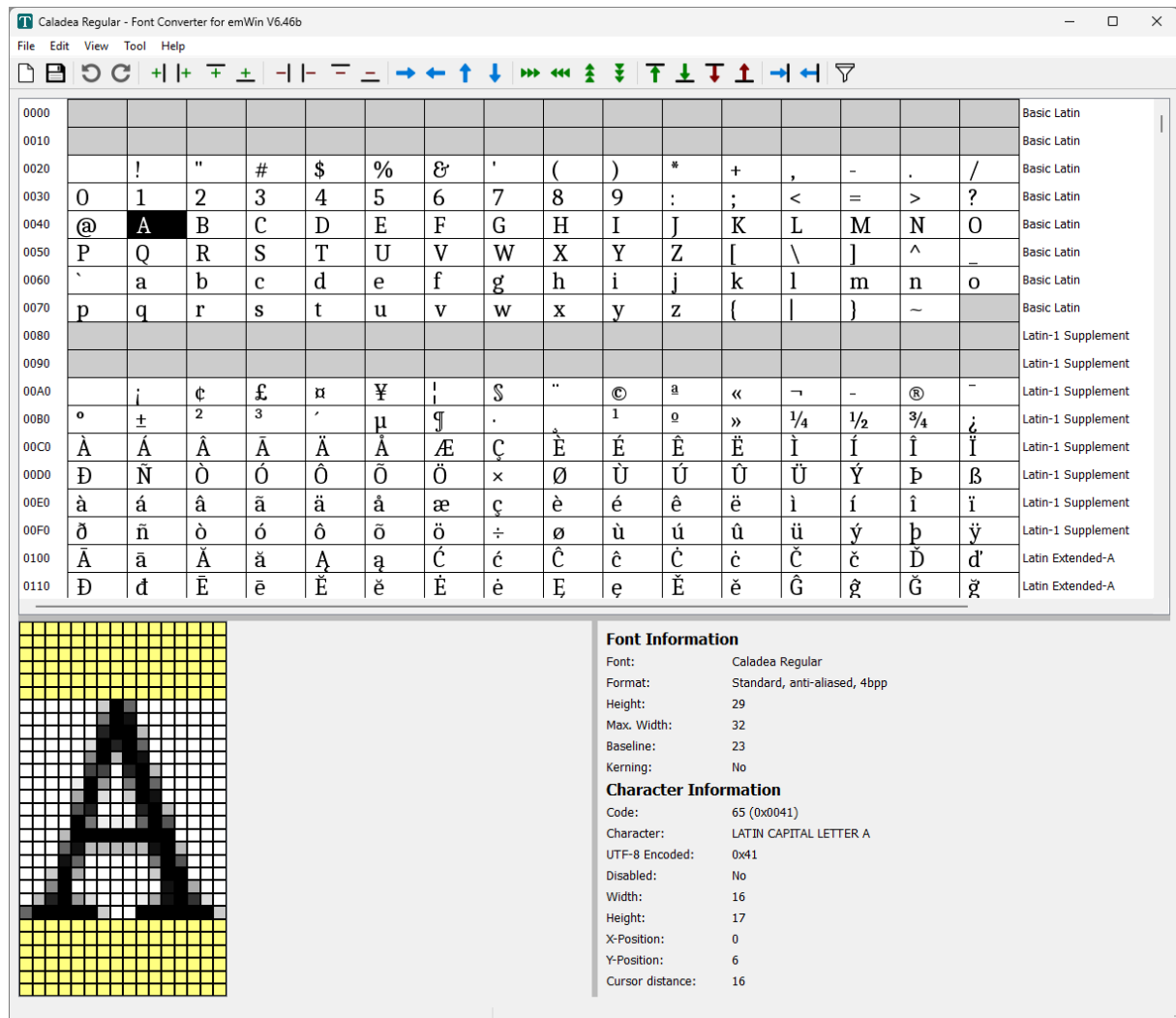



## 9.4.1 Supported file formats

The following table shows a summary of which font file formats are supported by the Font Converter. All of these file formats can be opened. Opened fonts can be saved in one of the three emWin formats.

- TrueType fonts (\*.ttf)
- OpenType fonts (\*.otf)
- TrueType collections (\*.ttc)
- Web Open Font Format (\*.woff)
- Glyph Bitmap Distribution Format (\*.bdf)
- emWin C font format (\*.c \*.cc \*.cpp \*.cxx \*.h \*.hh \*.hpp \*.hxx)
- emWin External Bitmap Font (\*.xbf)
- emWin System Independent Font (\*.sif)

## 9.4.2 Architecture

### System requirements

The Font Converter can be used on Windows platforms.

It uses the FreeType engine to render fonts. This means the user does not have to install TrueType-based fonts anymore to open them.

### Font indexing

The Font Converter previous to emWin V6.34 made use of the Windows font mapper to render fonts. This meant that font files needed to be installed on the user's PC and were indexed internally by the Windows font engine.

The main difference of using FreeType instead of the Windows font mapper is that FreeType does not know about installed fonts on the user's PC. A direct reference to a font file (either through a file path or through a buffer with the file data) is required to load and render it.

For the user the main advantage is that fonts do not need to be installed in order to be loaded. Instead, any supported font file can simply be opened by drag and drop or through the menu bar.

For convenient browsing through available font families, the font directories on the user's PC are indexed on start-up of the tool.

The system font directories is always indexed, but the user may also set custom font directories. More about this can be read in the *Preferences* sub-chapter under "Additional font directories".

Once new font directories have been added, the directories can be indexed again by clicking **Tool → Index font directories** in the tool bar.

### System font directories

The following table lists the standard font directories of each supported operating system.

Operating system	System font directories
Windows	<ul style="list-style-type: none"> <li>• C:\Windows\Fonts</li> <li>• C:\Users\<user>\AppData\Local\Microsoft\Windows\Fonts</user></li> </ul>

### 9.4.3 Creating an emWin font file from a font on the computer

The basic procedure for using the Font Converter for creating an emWin font file from a supported font is illustrated below. The steps are explained in detail in the following sections.

#### Step 1: Open an installed font or select a font file directly

The first step is to select the font file that should be converted. This can be done the following ways:

- Select an installed font from the font dialog with **File → New...** (CTRL + N) or
- Open a font file directly via **File → Open font file...** (CTRL + O).

#### Step 2: Specifying the type of font

For TrueType-based fonts, the dialog "Font generation options" will open. It allows selection of the destination font format. If legacy font formats are shown (explained later), the SJIS encoding may also be selected.

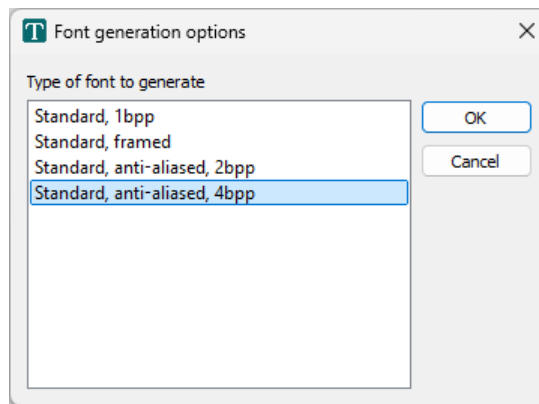

#### Step 3: Specifying the font

After confirming the previous dialog the font dialog is opened which allows choosing a font, its style and size.

The font families and styles in the selection lists depend on the font directories that were indexed. You can set a custom font directory to be indexed so that fonts in this directories are also shown in the dialog. Please see the section "Additional font directories" in the sub-chapter *Preferences* on page 3149.

In this example, a regular-style, 26 point Cascadia Code font is selected.

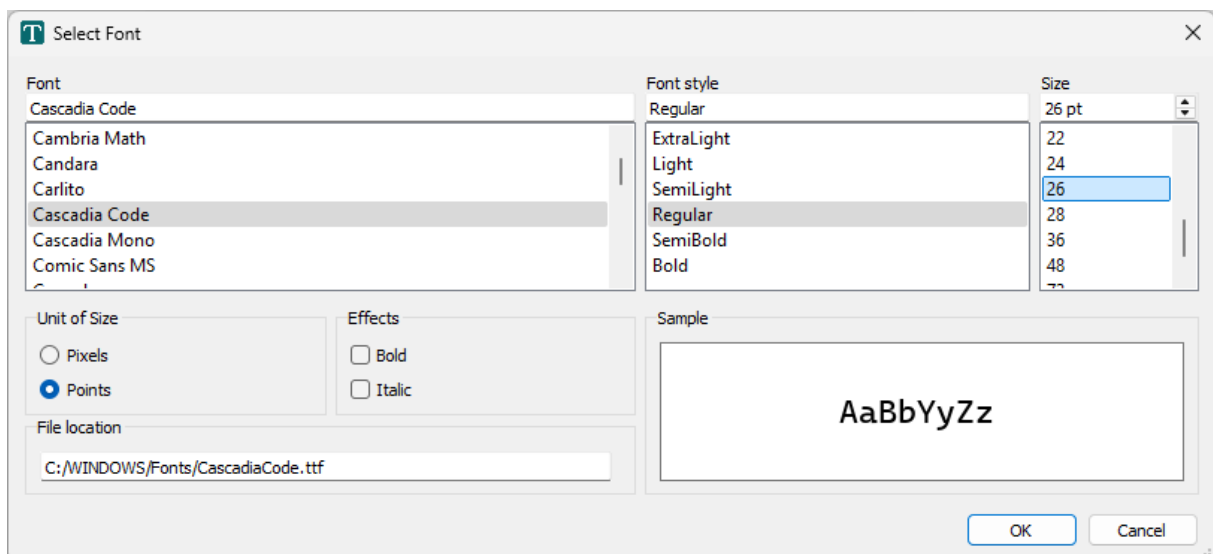

Please note that fonts with a size larger than 255 pixels in any direction can not be created nor displayed.

In case a TrueType-based font file has been selected with **File → Open font file...**, the same font dialog will appear but only showing the font families included in the selected file. The user may here select a style provided by the file and specify the font size as well.

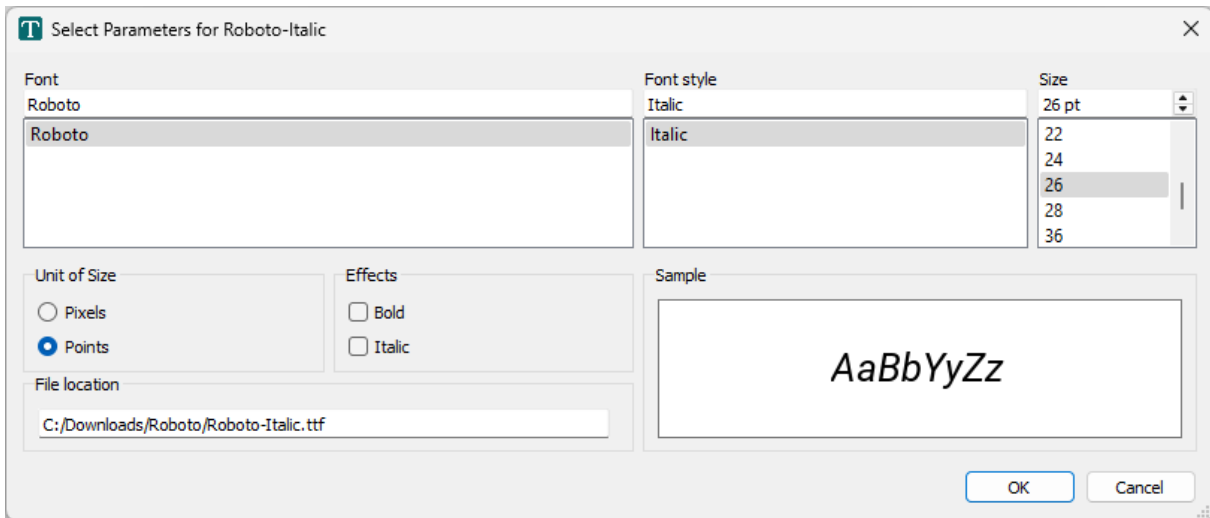

#### Step 4: Modifying the font

Detail information on the possibilities to modify the currently loaded font can be found in the section *User Interface* on page 3144.

#### Step 5: Saving the font file

Choosing **File → Save As...** from the menu bar opens the "Save font as" dialog which is shown below. In this dialog the desired format of the font file can be selected:

- C file (\*.\* \*.cc \*.cpp \*.cxx \*.h \*.hh \*.hpp \*.hxx)
- System independent font (\*.sif)
- External bitmap font (\*.xbf)

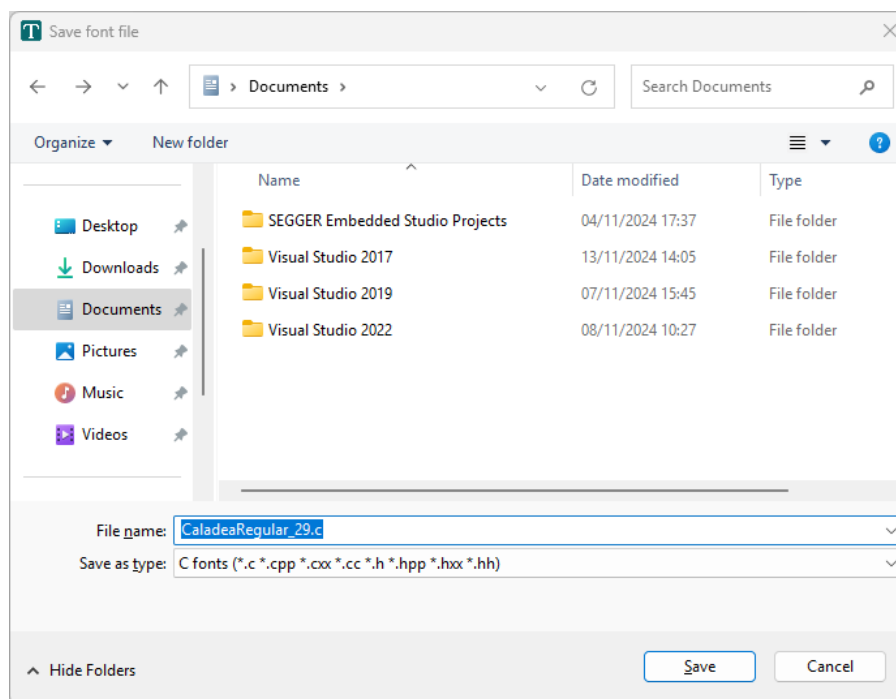

Clicking the **Save** button creates a font file of the selected format at the current location using the specified file name. Detailed information about the font types and how to use them can be found in the chapter *Fonts* on page 656.

## 9.4.4 Font Generation Options dialog

When triggering the menu option **File → New** the font generation dialog will open first. It allows selection of the destination font format and the destination encoding. Legacy font formats may or may not be shown, this is determined in the tool's preferences.

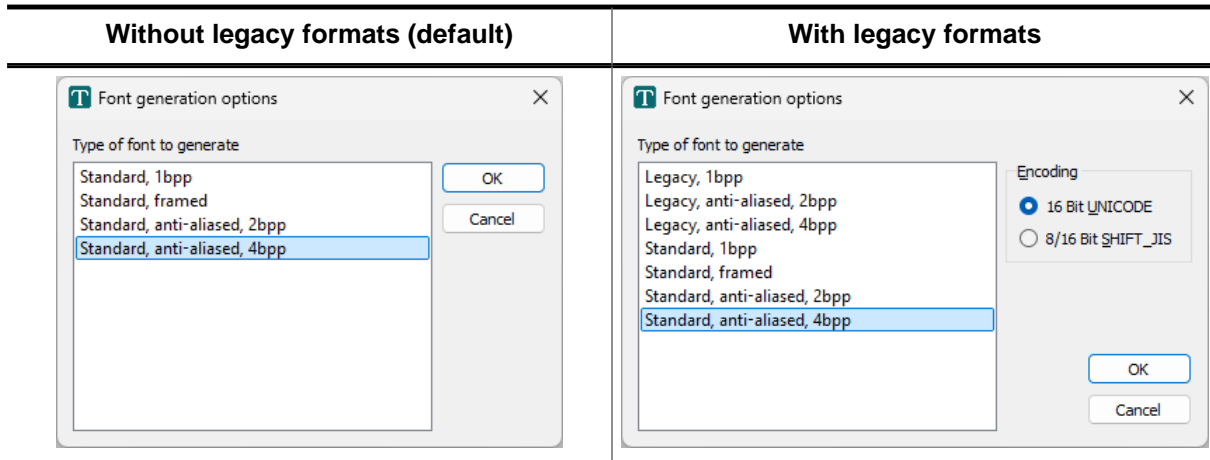

### 9.4.4.1 Type of font to generate

**Note**

With emWin V6.36, the old font formats that were formerly known as *Standard* fonts have been renamed to **Legacy** fonts. For more information about why this has been done, please see the note in the chapter *Font types* on page 657.

By default, the legacy formats are hidden in the tool. To show the formats when generating a new font, the option *Hide legacy formats* has to be disabled in the preferences.

Font type (since V6.36)	Font type (until V6.34g)	Description
<b>Legacy</b>	Standard	Creates a 1 bit per pixel font without anti-aliasing.
<b>Legacy, anti-aliased 2bpp</b>	Anti-aliased 2bpp	Creates an anti-aliased font using 2 bits per pixel.
<b>Legacy, anti-aliased 4bpp</b>	Anti-aliased 4bpp	Creates an anti-aliased font using 4 bits per pixel.
<b>Standard</b>	Extended	Creates a non anti-aliased 1 bit per pixel font with extended character information. This type supports compound characters like they are used in the Thai language.
<b>Standard, framed</b>	Extended, framed	Creates a non anti-aliased 1 bit per pixel font with extended character information with a surrounding frame. A framed font is always drawn in transparent mode regardless of the current settings. The character pixels are drawn in the currently selected foreground color and the frame is drawn in background color.
<b>Standard anti-aliased 2bpp</b>	Extended anti-aliased 2bpp	Creates an anti-aliased 2 bit per pixel font with extended character information. Each character has the same height and its own width. The pixel information is saved with 2bpp anti-aliasing information and covers only the areas of the glyph bitmaps.
<b>Standard anti-aliased 4bpp</b>	Extended anti-aliased 4bpp	Creates an anti-aliased 4 bit per pixel font with extended character information. Each character has the same height and its own width. The pixel information is saved with 4bpp anti-aliasing information and covers only the areas of the glyph bitmaps.

## 9.4.4.2 Encoding

Encoding	Description
Unicode 16 Bit	With Unicode encoding, you have access to all characters in a font. Windows font files contain a maximum of 65536 characters. All character codes of the C file are the same as those in the Windows font file.
SHIFT JIS 8/16 Bit	Shift JIS (Japanese Industry Standard) enables mapping from Unicode to Shift JIS in accordance with the Unicode standard 2. For example, the Katakana letter "KU" is shifted from its Unicode value of 0x30AF to the Shift JIS value of 0x834E, the Kanji character 0x786F is shifted to 0x8CA5 and so on.

## 9.4.5 Font Dialog

The Font Dialog opens after the font generation options have been confirmed:

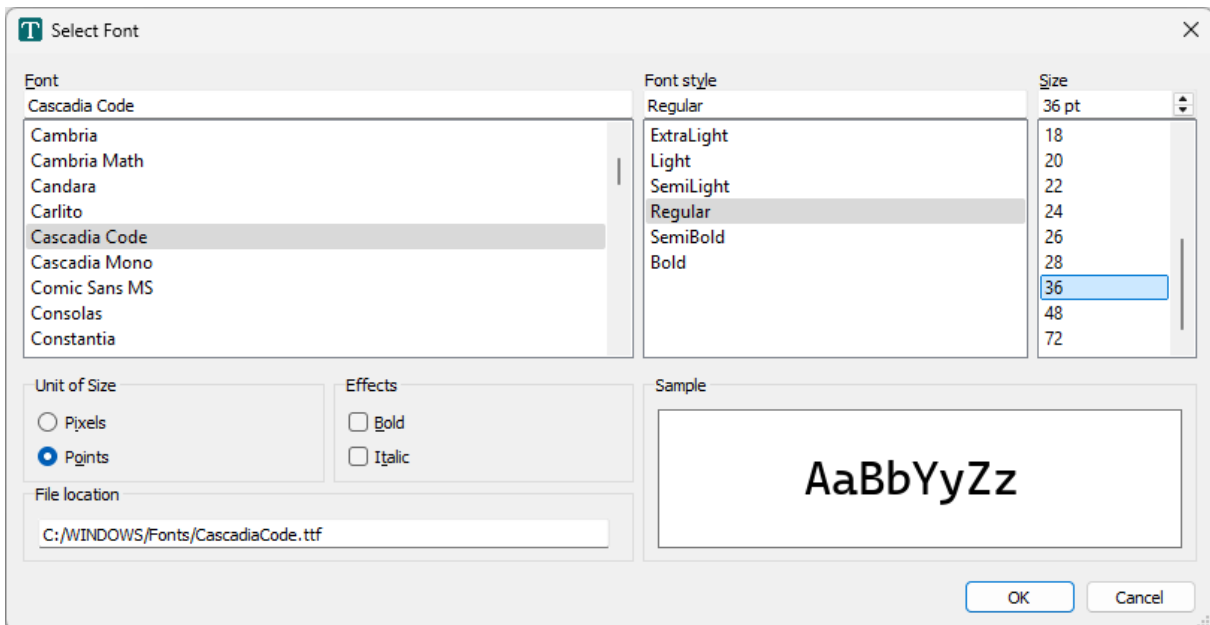

This dialog allows selecting a font to be loaded in the Font Converter. Confirming this dialog using the 'OK' button opens the font and the included characters of that font are rendered and displayed in the main user interface.

### Note

Fonts which are legally owned by third parties may require a valid license in order to use them in a target system. emWin does not include any licenses for third-party fonts.

All fonts included in emWin can be used according to the license under which emWin was provided. Detailed listings of those fonts and the included character sets can be found under *Standard fonts* on page 666.

### 9.4.5.1 Font, font style and size

These menus are used to select the particular font family and style to be converted. The size of the font is specified in pixels or points.

### 9.4.5.2 Unit of Size

This option button can be used to set points or pixels as measuring unit. Point sizes are converted to pixel sizes using this formula:

$$\text{Pixel size} = (\text{Point size} * \text{DPI}) / 72$$

### Note

The current DPI is used for this calculation. This means that e.g. if the Font Converter is scaled to 125% by the operating system, 16pt would be 26px, whereas with 100% scaling 16pt equals 21px.

### 9.4.5.3 Effects

Effects may be used to perform additional transformations before the glyphs are rendered. The glyphs may be emboldened and/or italicized.

This is useful when there is only a regular style of a font family is available, but additional styles are required.

#### 9.4.5.4 Sample

The sample box in the font dialog renders a sample string to display what the currently selected font looks like.

##### Note

The sample string is rendered using FreeType, not using emWin. Therefore the displayed string may not look like the exact same as when rendering the string in emWin using the same font.

### 9.4.6 User Interface

After clicking OK in the Font dialog box, the main user interface of the Font Converter appears, loaded with the previously selected font. You may convert the font into a C file immediately if you wish or edit its appearance first.

The Font Converter is divided into two areas. In the upper area, all font characters appear scaled 1:1 as they will be displayed on your target device. Disabled characters are shown with a gray background. Per default all character codes which are not included in the chosen font are disabled. For example, many fonts do not include character codes from 0x00 to 0x1F and 0x7F to 0x9F, so these codes are grayed out.

The current character is displayed in a magnified scale on the left side of the lower area. Additional information about the font and the current character can be seen on the right side. If you want to modify the character data, you must first focus the lower area, either by pressing the <TAB> key or by simply clicking in the area.

#### 9.4.6.1 Selecting the current character

Characters may be selected:

- by using the keys <UP>, <DOWN>, <LEFT>, <RIGHT>, <PGUP>, <PGDOWN>, <POS1> or <END>
- by clicking a character with the left mouse button
- by using the "Go to character..." dialog

##### "Go to character..." dialog

This dialog allows entering a desired character code (in hexadecimal or decimal) to move the selection to the given character.

The dialog can be opened by clicking **View → Go to character...** or by pressing CTRL + G.

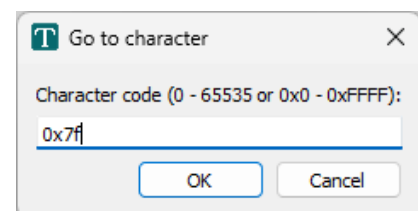

#### 9.4.6.2 Toggling character status

Use the right mouse button to toggle the status of a specific character or to enable/disable an entire row or block of characters.



The menu point **Edit → Toggle character** as well as the <SPACE> key will toggle the status of the current character.

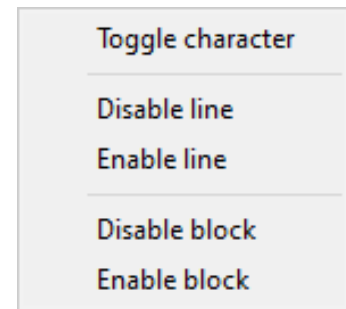

If you need to change the status of a particular range of characters, choose **Edit → Enable range of characters...** or **Edit → Disable range of characters...** from the menu. The range to be enabled or disabled is then specified in a dialog box using hexadecimal or decimal character values.

To disable all characters, select **Edit → Disable all characters** from the menu.

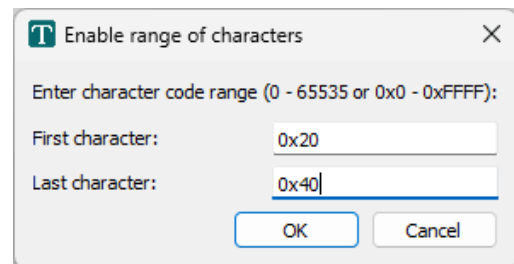

### 9.4.6.3 Selecting pixels

When the lower area of the user interface is activated, you can move through the pixels with the cursor, either by using the <UP>, <DOWN>, <LEFT> and <RIGHT> keys or by clicking on the pixels with the left mouse button.

### 9.4.6.4 Modifying character bits

In the lower-left corner of the tool you can find the bitmap view of the currently selected character.

Pixels can be selected and inverted using the <SPACE> key. If the font format is anti-aliased the intensity of a pixel can be increased and decreased with the keys <+> and <->.

The yellow area is used in non-legacy fonts to represent the spacing used for the character. Since the spacing solely depends on the font height and character metrics, it cannot be edited using the character bitmap view.

When a framed font is currently loaded, the character frame is also shown here in blue. The frame itself cannot be edited, because it is generated according to the normal character bitmap. This means once character bits are changed, a new frame is also generated.

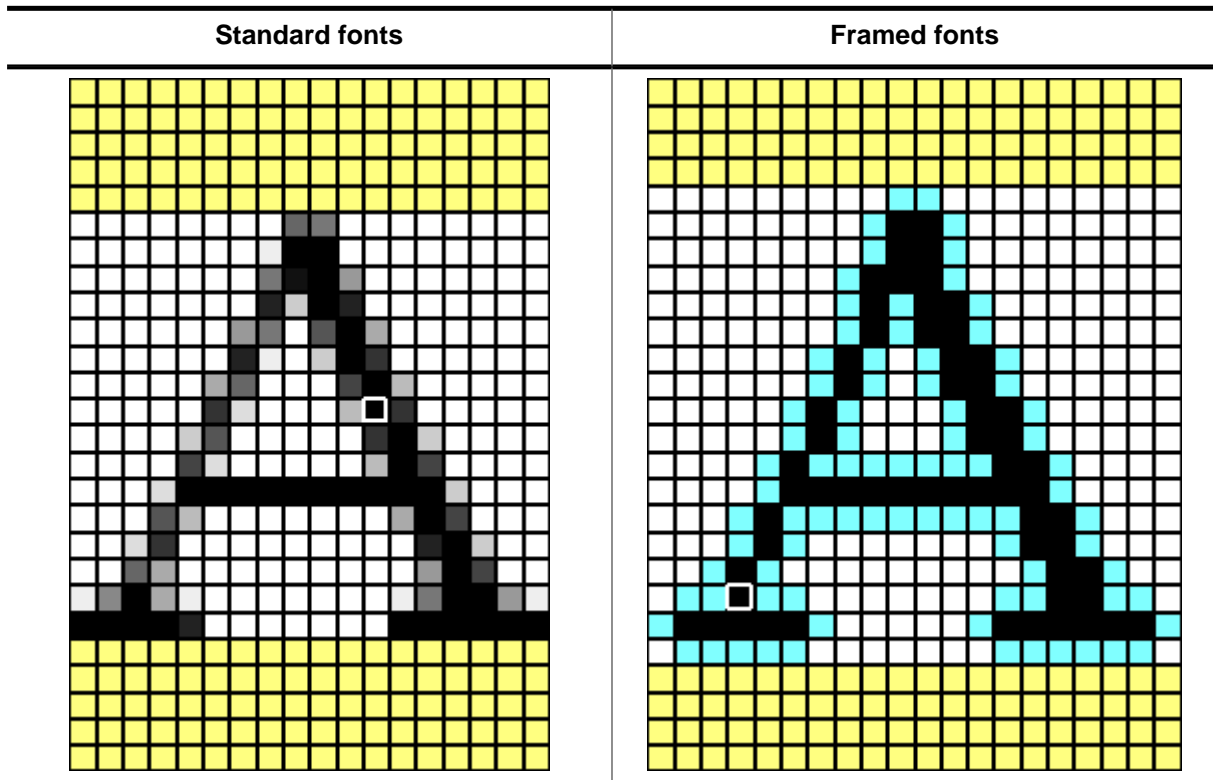

While hovering the mouse over a pixel, the status bar displays the intensity of that pixel.

Index of pixel [11, 7]: 15

A right click on a pixel also shows a context menu with all possible manipulation options on the pixel.

### 9.4.6.5 Character and font manipulation

There are a number of different operations available to manipulate data regarding characters or the entire font.

#### Size operations





The size of a character (the font) may be modified by selecting **Edit → Insert → Right, Left, Top, Bottom** or **Edit → Delete → Right, Left, Top, Bottom** from the menu, or by using the toolbar:

Button	Operation
+	Add one column to the right edge of the character bitmap. Increases horizontal character size by 1.
+	Add one column to the right edge of the character bitmap. Increases horizontal character size by 1.
+ <u>+</u>	Add one row to the top edge of the character bitmap. Increases vertical character size by 1.
+ <u>+</u>	Add one row to the bottom edge of the character bitmap. Increases vertical character size by 1.
-	Delete one column at the right edge of the character bitmap. Decreases horizontal character size by 1.
-	Delete one column at the left edge of the character bitmap. Decreases horizontal character size by 1.
<u>-</u>	Delete one row of the top edge of the character bitmap. Decreases vertical character size by 1.

Button	Operation
	Delete one row of the bottom edge of the character bitmap. Decreases vertical character size by 1.





### Shift operations

Choose **Edit → Shift → Right, Left, Up** or **Down** from the menu to shift the bits of the current character in the respective direction, or use the toolbar:

Button	Operation
	Shift all pixels to the right.
	Shift all pixels to the left.
	Shift all pixels up.
	Shift all pixels down.



### Move operations (standard font formats only)

Choose **Edit → Move → Right, Left, Up** or **Down** from the menu to move the character position in the respective direction, or use the toolbar:

Button	Operation
	Move image to the right.
	Move image to the left.
	Move image up.
	Move image down.





### Change cursor distance (standard font formats only)

Choose **Edit → Cursor distance → Increase** or **Decrease** from the menu to move the character position in the respective direction, or use the toolbar:

Button	Operation
	Increase cursor distance.
	Decrease cursor distance.

### Change font height (standard font formats only)



Choose **Edit → Font height → [Insert, Delete] [top, bottom]** from the menu to add or remove a row to or from the font, or use the toolbar:

Button	Operation
	Insert a row at the top of the font.
	Insert a row at the bottom of the font.
	Delete a row from the top of the font.
	Delete a row from the bottom of the font.

## Undo/Redo system

The undo and redo buttons allow reversing any action that has had an effect on the current font.

This includes all the above-mentioned size, shift, move, etc. operations, as well as manipulating the pixel values of bitmaps, merging of fonts or changing the enable state of characters.

Button	Operation
	Un-does the last performed action.
	Re-does the last undone action.

The undo/redo history is linear, that means there won't be multiple histories if actions are undone and new actions are performed. When this is the case, the actions that were undone will be cleared and the new performed actions will be added to the history.

### 9.4.6.6 Modifying the viewing mode

The view mode may be changed by selecting the following options from the menu:

#### View/All Characters

If enabled (default), all characters are shown. If disabled, only the rows with at least one enabled character are shown.

Button	Operation
	Toggles viewing mode.

### 9.4.7 Batch Editing of character metrics

To efficiently edit the metrics of a given range of characters, the Batch Edit dialog can be used.

Open the dialog by clicking **Edit → Batch Edit....**

A range of characters to be edited can be specified in either hexadecimal or decimal values. Then, the desired action can be selected and the amount of iterations, or the new value to be set, depending on the action.

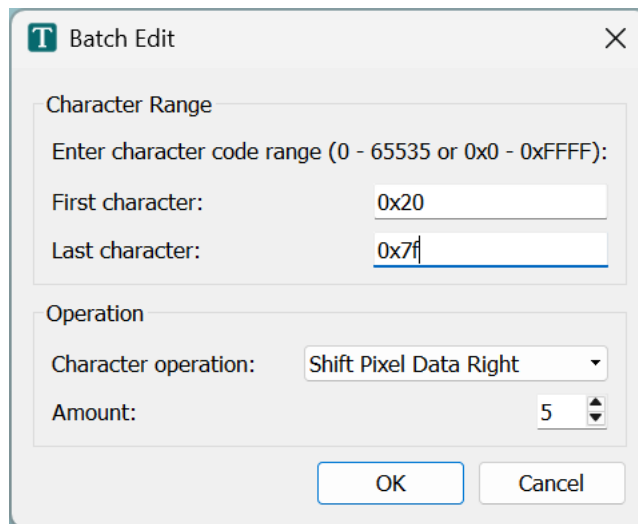

### 9.4.8 Preferences

The preferences dialog can be opened by clicking **Tool → Preferences....**

#### 9.4.8.1 General

##### Logging

Option	Default	Description
<b>Log actions in C file headers</b>	Enabled	Logs all actions performed on a font and writes them into a header at the top of C files.
<b>Create log file in working directory</b>	Disabled	Exports the log of all actions into a separate .log file

##### Line endings

Allows to select between the following line endings that are added to generated C font files:

- Windows-style line endings (CR LF)
- Mac-style line endings (CR)
- Linux-style line endings (LF)

### 9.4.8.2 Fonts

#### Fonts options

Option	Default	Description
<b>Use included bitmap sizes</b>	Enabled	Some TTF fonts have included bitmaps for smaller font sizes. When this setting is enabled, these included bitmaps are always preferred over rendering the glyph bitmaps normally.
<b>Normalize negative character positions</b>	Disabled	Some TTF fonts may include glyphs with negative Y positions. emWin would not display the full glyph, but would clip at Y position 0. When this option is enabled, empty rows will automatically be inserted at the top edge of the font until no glyph has a negative Y position. This procedure could also be done manually after the font has been loaded.

#### Additional font directories

Here, custom user directories can be set that will be searched for fonts on start-up of the Font Converter.

Any TrueType-based fonts that are found in the user font directories (as well as the system directories) are then known by the Font Converter. For the user this means two things:

- The font will be shown in the font dialog (under **File → New...**).
- The font can be opened via command line just by entering its family and style name (through the `-create` command).

After clicking *Edit font directories...*, a dialog will open:

Through the buttons on the top, directories may be added or deleted.

Optionally, the user font directories may also be indexed recursively. Please note that the recursion depth is limited to 10 directories.

When the custom directories have been modified, they can be re-indexed by clicking **Tool → Index font directories**.

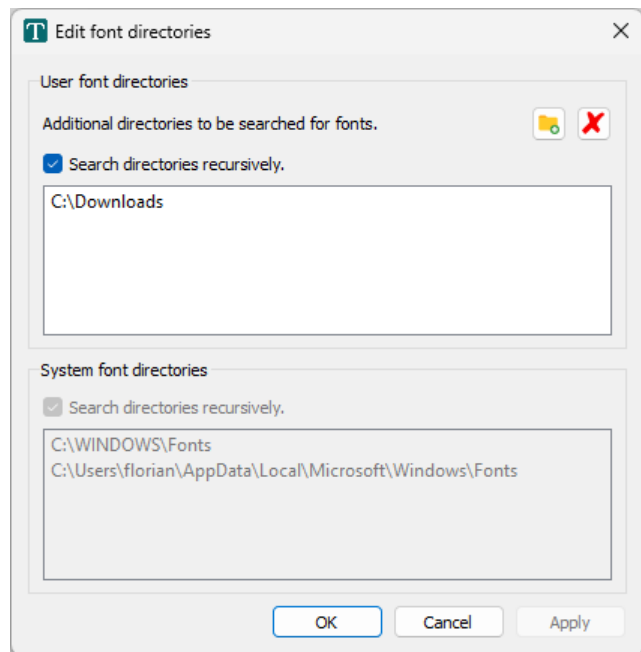

### 9.4.8.3 User Interface

#### Legacy options

Option	Default	Description
<b>Hide legacy font formats</b>	Enabled	Hidden legacy font formats means that the formats that were formerly called "Standard" are not shown in the font generation dialog.

Option	Default	Description
		This does not have an impact on opening existing legacy font files, this is always possible whether or not this option is set.

### Numeral system

Allows to choose between hexadecimal and decimal as the default numeral system used in dialogs that require char codes to be entered.

When hexadecimal is selected (default) the "0x" prefix is automatically added to line edits, so that they don't need to be entered manually every time.

Currently, the only dialogs this option affects are the dialog for enabling or disabling characters and the "Go to char" dialog.

### Reset UI state

Clears all automatically saved states that are related to the Font Converter's GUI. This mainly includes the size and position of opened dialogs and windows, or entered options within dialogs.

### 9.4.9 Saving a font file

As mentioned before, the Font Converter can save opened fonts into one of the three font formats supported by emWin:

- C file (\*.c \*.cc \*.cpp \*.cxx \*.h \*.hh \*.hpp \*.hxx)
- System independent font (\*.sif)
- External bitmap font (\*.xbf)

All of these formats are explained in more detail in the chapter *Font formats* on page .

To save the font file, select **File → Save As...** or press CTRL + S. A file dialog will open, select the correct file filter for the format you want to the save font in. Then, select the desired destination path and file name and finally press "Save".

### 9.4.10 Loading and modifying existing emWin fonts

The Font Converter is also able to open existing font files and to modify their font data. The tool can open any of the three above-mentioned font formats.

#### Note

If C font files have been modified manually, it can not be guaranteed that they can be opened by the Font Converter. The tool is not compiling the C font, it is only parsing the text contents of the C file.

To open an emWin font file, simply select **File → Open font file...** in the tool bar or press CTRL + O.

### 9.4.11 Merging fonts with other font files

The Font Converter is able to add the content of an existing font file to the current font data. Once a font has been loaded via **File → Open font file...** or created by **File → New...** any other supported font file can be merged to it using **File → Merge font file....**

#### Notes about merging fonts

- If an existing emWin font file (C, XBF or SIF) is loaded for merging, the two fonts need to be of the same font format.
- In case the sizes of the two fonts are different, the smaller font will be automatically adjusted to the size of the larger font.

#### Duplicate characters in both fonts (merge mode)

In case duplicate characters are found in both fonts that are to be merged, the user will be asked whether the duplicate characters should be overwritten or left unchanged:

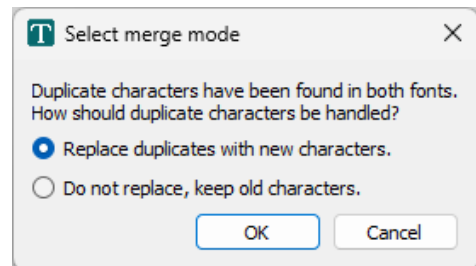



## 9.4.12 Pattern files

In order not having to enable every single required character manually, pattern files can be used. Pattern files are simple text files that include the text which has to be displayed in the application. They need to be saved in Unicode format (LE) including a BOM (Byte Order Mark) at the beginning.

### 9.4.12.1 Creating pattern files using Notepad

One option for creating a pattern file is to use Notepad, which is part of the Windows accessories:

- Copy the text you want to display into the clipboard.
- Open Notepad.exe.
- Insert the contents of the clipboard into the Notepad document.
- Use **Format → Font** to choose a font which contains all characters of the text. You can skip this step if you do not want to see the characters.
- Use **File → Save As** to save the pattern file. It is very important that you save the file in text format encoding **UTF-16 LE BOM**.

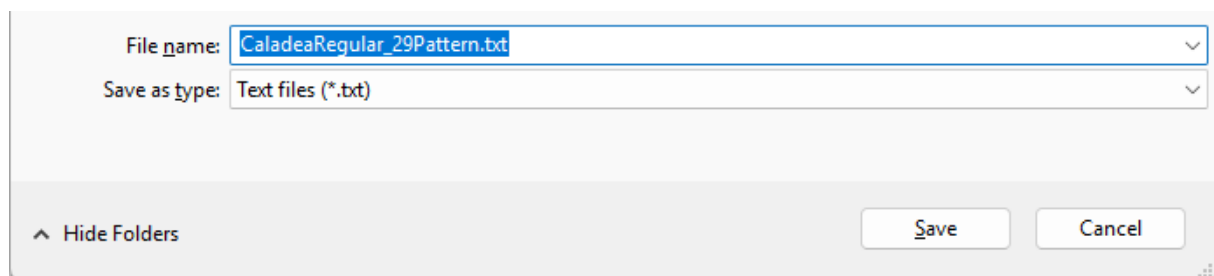

### 9.4.12.2 Creating pattern files using the Font Converter

A pattern file may also be created directly in the Font Converter. Select **Edit → Save pattern file** from the menu to create a text file which includes all currently enabled characters.

### 9.4.12.3 Enabling characters using a pattern file

It is usually helpful to begin by disabling all characters. Select **Edit → Disable all characters** from the menu if you need to do so. Now choose **Edit → Read pattern file**. After opening the appropriate pattern file, all characters included in the file are enabled. If the pattern file contains characters which are not included in the currently loaded font, a message box will appear.

## 9.4.13 Kerning files

To be able to use kerning with standard fonts kerning tables are required. A kerning table has to fit exactly for the font it has been created for. Such a kerning table contains a set of kerning pairs. Each kerning pair consists of the codepoints it should be used for and the kerning distance. The kerning distance is used to adjust the horizontal cursor before drawing the character.

### 9.4.13.1 Saving a kerning file

If kerning is needed we recommend saving the kerning file immediately after the font file. Select **File → Save kerning table...** to do so.

### 9.4.13.2 Using the kerning table

A file with a kerning table contains two things:

```
//  
// Kerning pairs  
//  
GUI_CONST_STORAGE U16 aMyFont_64_Kerning[] = {  
    0x0020, 0x0041, (U16)-3, 0x0020, 0x0054, (U16)-1, 0x0020, 0x0059, (U16)-1, ...  
    0x0041, 0x0020, (U16)-3, 0x0041, 0x0054, (U16)-4, 0x0041, 0x0056, (U16)-4, ...  
    ...  
    0x0077, 0x002E, (U16)-3, 0x0079, 0x002C, (U16)-4, 0x0079, 0x002E, (U16)-4,  
};  
  
//  
// Number of kerning pairs: 95  
//  
U32 MyFont_64_Kerning_NumPairs = (sizeof(aMyFont_64_Kerning) / sizeof(aMyFont...
```

- The kerning table itself.
- The number of kerning pairs in that table.

For more details about kerning please refer to the chapter *Fonts* on page 656.

## 9.4.14 Command line usage

The Font Converter also allows usage from command line. In the installation directory, the GUI build of the tool is included, as well as a command line version (suffixed with `_CL`).

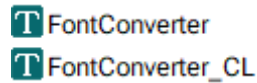

Both executables accept the same command line syntax, the only difference is that the command line tool prints output to the command line and is not dependent on the QtGui DLL.

### Command processing

For processing of the command line arguments, the following rules apply:

- Opening of a font file or creation of a given font is always done first.
- Saving of the resulting file is always done in the end (right before `-exit`).
- If the `-exit` argument is given, it is executed as the last argument.
- All other commands are processed from left to right.

### General notes about the syntax

- Commands are always prefixed with a minus sign, e.g. `-create`.
- Commands can be entered using their long name (e.g. `-format`) or their short flag, if available (e.g. `-f`).
- A command and its parameters are always separated by a space, e.g. `-create <parameters>...`
- Multiple command parameters are not separated by spaces, but by a comma, e.g. `-create Roboto,Bold`.
- If spaces need to be included in a parameter, use quotes, e.g. `-create "Arial Unicode MS",Bold`.

### Legacy syntax

The command line syntax used in the Font Converter previous to emWin V6.34 is still supported, but for the sake of simplicity, it is not included in this manual anymore.

#### 9.4.14.1 Summarized syntax

A short summary of the command line usage of the tool with all available commands can be seen below.

```
FontConverter_CL.exe {<file path>|-c <family name>,<style name>}
                    [-h <font height>{px|pt}]
                    [-f <output font format>]
                    [-b]
                    [-i]
                    [-fi <index>]
                    [-enc <UC|SJIS>]
                    [-e {<first char>[-<last char>]|all}] ...
                    [-d {<first char>[-<last char>]|all}] ...
                    [-p <file path>] ...
                    [-ef <action>[,<count>]] ...
                    [-ec <action>,{<first char>[-<last char>]|all}[,<value>]] ...
                    [-m <file path>[,<REPLACE|KEEP>]]
                    -s <file path>
                    [-lf]
                    [-v]
                    [-x]
                    [-hide]
                    [-?]
```

- Three dots ... after a command indicate that the command can be supplied multiple times.
- Parameters within square brackets [ ] are optional.

- Parameters or arguments separated by vertical pipes | represent a choosing option, meaning one of them has to be supplied.

### 9.4.14.2 Table of commands

The following table shows the available command line options:

Command	Flag	Parameters	Description
		<file path>	Open font file. Allowed are TTF, TTC, BDF, C, XBF and SIF font files. <b>Note:</b> This command is positional, meaning it is only accepted as the first command and it must not be prefixed with any kind of flag.
-create	-c	<family name>, <style name>	Creates a new font file from family and style name. The font will be looked up according to the set font directories.
-height	-h	<font height>{px pt}	Height of font in pixels or points. Only required for generating TrueType fonts. If no format suffix is supplied, the integer is assumed to be in pixels.
-format	-f	<font format>	Output font format. Legal values for <font format>: LEG - Legacy, 1bpp LEG_AA2 - Legacy, 2bpp LEG_AA4 - Legacy, 4bpp STD - Standard, 1bpp FRM - Standard, framed AA2 - Standard, anti-aliased, 2bpp AA4 - Standard, anti-aliased, 4bpp
-bold	-b		Emboldens the outline of each character. Only used for TTF and TTC.
-italic	-i		Italicizes each character by a fixed angle. Only used for TTF and TTC.
-face	-fi	<index>	Face index to be used (optional, only used for TTC fonts and multi-master TTF fonts).
-encoding	-enc	<encoding>	Destination encoding of the font. Legal values for <encoding>: UC - 16-bit Unicode encoding. SJIS - Shift JIS (Shift Japanese Industrial Standards) encoding.
-enable	-e	{<first char>[-<last char>] all}	Enable a range of characters. Allowed are decimal or hexadecimal ranges (e.g. 0x10-0x30), single character codes or "all".
-disable	-d	{<first char>[-<last char>] all}	Enable a range of characters. Allowed are decimal or hexadecimal ranges (e.g. 0x10-0x30), single character codes or "all".
-readpattern	-p	<file path>	Reads a pattern file.
-editfont	-ef	<action>[, <count>]	Equivalent to the 'Edit' menu (font dependent). Legal values for <action>: INSTOP - Inserts a row at the top of the font. INSBOTTOM - Inserts a row at the bottom of the font. DELTOP - Deletes a row at the top of the font. DELBOTTOM - Deletes a row at the bottom of the font.
-editchar	-ec	<action>, {<first char>[-<last char>] all} [, <value>]	Equivalent to the 'Edit' menu (character dependent). Legal values for <action>: SHIFTR - Shifts pixel data of character range to the right by <value> px. SHIFTL - Shifts pixel data of character range to the left by <value> px. SHIFTU - Shifts pixel data of character range up by <value> px. SHIFTD - Shifts pixel data of character range down by <value> px. MOVER - Moves the character range by <value> pixels to the right.

Command	Flag	Parameters	Description
			MOVEL - Moves the character range by <value> pixels to the left. MOVEU - Moves the character range by <value> pixels up. MOVED - Moves the character range by <value> pixels down. INST - Insert <value> rows at the top of the character range. INSB - Insert <value> rows at the bottom of the character range. INSL - Insert <value> columns on the left of the character range. INSR - Insert <value> columns on the right of the character range. DELT - Delete <value> rows from the top of the character range. DELB - Delete <value> rows from the bottom of the character range. DELL - Delete <value> columns from the left of the character range. DELR - Delete <value> columns from the right of the character range. CINC - Increments the cursor distance for the given range <value> times. CDEC - Decrements the cursor distance for the given range <value> times.
-merge	-m	<file path>[, <merge mode>]	Merge the currently loaded font with another font file. Only C, XBF, SIF and BDF allowed. Legal values for <merge mode>: REPLACE - Replaces duplicate characters in opened font with characters from new font. KEEP - Retains duplicate characters in opened font.
-save	-s	<file path>	Save font file at the given file location. The selected output format will be deduced from the given file extension.
-listfonts	-lf		Lists all font families and styles found in the given font directories. These fonts may be used in the -create command.
-verbose	-v		Enables verbose mode, prints every action performed on the font (i.e. the entire log).
-exit	-x		Exits the command line.
-hide			Hides the application window in GUI mode.
-help	-?		Displays usage information and exits.

### 9.4.14.3 Loading a font file from command line

#### Loading from file path

To load any font file of the supported file types (TrueType-based, BDF, C, SIF or XBF) the open font file command listed as the first command in the above table can be used.

Simply pass the file path as the first argument:

```
FontCvt.exe FontFile.xbf
```

#### Loading from family name

Alternatively to the file path, TrueType-based fonts may also be opened with the -create command, which means passing the family and style name of the font.

The given family will be looked up in the font directories that were set.

```
FontCvt.exe -c Roboto,Bold
```

### 9.4.14.4 Execution examples

Load the font **Roboto Bold** with a height of 48 pixels and save it as a C font in the format "Standard, anti-aliased, 4bpp".

```
FontCvt.exe -c Roboto,Bold -h 48px -f AA4 -s Roboto.c
```

Read the C font file `FontFile.c`, disables all characters, reads a pattern file and saves it.

```
FontCvt.exe FontFile.c -d all -p Pattern.txt -s OutputFont.c
```

Open a TrueType collection file, selects face index 1, sets the font height to 24 points and saves it as an XBF file in the format "Standard, anti-aliased, 2bpp".

```
FontCvt.exe cambria.ttc -h 24pt -face 1 -f AA2 -s Cambria.xbf
```

### 9.4.15 Differences to old Font Converter versions

Although the latest version of the Font Converter is fully backward compatible, users may notice differences in the output between the newer and older versions of the tool.

Since version 6.36, the Font Converter employs a new method for retrieving font metrics from font files. As a result, the properties of the generated fonts may differ from those produced by earlier versions of the Font Converter.

The degree of these differences may vary based on the particular font in use.

Below is a comparison of the character 'A' generated by the old and new versions of the Font Converter. The generated font is Noto Sans with a height of 24 pixels. As a result, it may be necessary to adjust the font sizes when updating older projects with fonts generated by the new Font Converter.

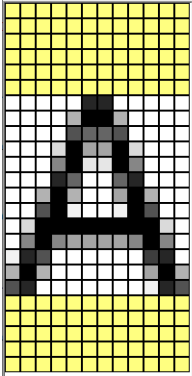
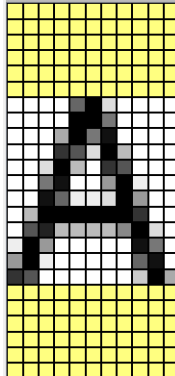
Font Cvt before V6.36	Font Cvt since V6.36
 <div data-bbox="443 1211 738 1585"> <p><b>Font Information</b>  Font: Noto Sans  Height: 24  Max Width: 33  Baseline: 19</p> <p><b>Character Information</b>  Code: 65 (0x0041)  Character: LATIN CAPITAL LETTER A  Width: 12  Disabled: No  Height: 13  X-Position: 0  Y-Position: 6  Cursor dist: 11</p> </div>	 <div data-bbox="1034 1211 1345 1585"> <p><b>Font Information</b>  Font: Noto Sans Regular  Format: Standard, anti-aliased, 4bpp  Height: 24  Max. Width: 47  Baseline: 18  Kerning: No</p> <p><b>Character Information</b>  Code: 65 (0x0041)  Character: LATIN CAPITAL LETTER A  UTF-8 Encoded: 0x41  Disabled: No  Width: 11  Height: 12  X-Position: 0  Y-Position: 6  Cursor distance: 11</p> </div>

## 9.4.16 Font Examples

This section provides examples of C files generated by the Font Converter in standard and in 4bpp anti-aliased mode, respectively.

### 9.4.16.1 Resulting C code, standard mode

The following is an example of a C file in standard mode:

```

/*****
 *                               SEGGGER Microcontroller GmbH
 *                               Solutions for real time microcontroller applications
 *                               www.segger.com
 *****/
 *
 * C-file generated by
 *
 * Font Converter V6.34
 * Compiled: 14:16:45 Jul 24 2023
 *
 * Copyright (c) SEGGGER Microcontroller GmbH 1998 - 2023
 *
 *****/
 *
 * File:   Arial13_1bpp.c
 * Font:   Arial Regular
 * Height: 13
 *
 *****/
 *
 * [Font]: Initial height of font: 13px.
 * [Font]: Disabled all characters.
 * [Char 0x0041]: Enabled.
 *
 *****/
 */

#include "GUI.h"

#ifndef GUI_CONST_STORAGE
#define GUI_CONST_STORAGE const
#endif

//
// The following line needs to be included in any file selecting the font.
// font.
//
extern GUI_CONST_STORAGE GUI_FONT GUI_FontArial13_1bpp;

//
// Start of unicode area Basic Latin
//
static GUI_CONST_STORAGE unsigned char acGUI_FontArial13_1bpp_0041[9] = { // Code
    0041, LATIN CAPITAL LETTER A
    _X_,
    _X_X_,
    _X_X_,
    _X_X_,
    _X_X_,
    _XXXX_,
    _X_X_,
    X_X_,
    X_X_,
};

static GUI_CONST_STORAGE GUI_CHARINFO_EXT GUI_FontArial13_1bpp_CharInfo[1] = {
    { 7, 9, 0, 2, 7, acGUI_FontArial13_1bpp_0041 }, // Code
    0041, LATIN CAPITAL LETTER A
};

static GUI_CONST_STORAGE GUI_FONT_PROP_EXT GUI_FontArial13_1bpp_Prop1 = {
    0x0041, // First character
    0x0041, // Last character
    &GUI_FontArial13_1bpp_CharInfo[0], // Address of first character
};

```

```

(GUI_CONST_STORAGE GUI_FONT_PROP_EXT *)0, // Pointer to next GUI_FONT_PROP_EXT
};

GUI_CONST_STORAGE GUI_FONT GUI_FontArial13_1bpp = {
    GUI_FONTTYPE_PROP_EXT, // Type of font
    13, // Height of font
    13, // Vertical space of font
    1, // Magnification in X
    1, // Magnification in Y
    {&GUI_FontArial13_1bpp_Prop1}, // Pointer to first block
    11, // Baseline
    16, // Height of lowercase characters
    22, // Height of capital characters
};

/***** End of file *****/

```

## 9.4.16.2 Resulting C code, 4 bpp anti-aliased mode

The following is an example of a C file in 4 bpp anti-aliased mode:

```

/*****
 *                               *
 *          SEGGER Microcontroller GmbH                               *
 *          Solutions for real time microcontroller applications       *
 *                               www.segger.com                       *
 *****/
 *
 * C-file generated by
 *
 *          Font Converter V6.34
 *          Compiled: 14:16:45 Jul 24 2023
 *
 *          Copyright (c) SEGGER Microcontroller GmbH 1998 - 2023
 *
 *****/
 *
 * File:   Arial13_4bpp.c
 * Font:   Arial Regular
 * Height: 13
 *
 *****/
 *
 * [Font]: Initial height of font: 13px.
 * [Font]: Disabled all characters.
 * [Char 0x0041]: Enabled.
 *
 *****/
 */

#include "GUI.h"

#ifndef GUI_CONST_STORAGE
#define GUI_CONST_STORAGE const
#endif

//
// The following line needs to be included in any file selecting the font.
// font.
//
extern GUI_CONST_STORAGE GUI_FONT GUI_FontArial13_4bpp;

//
// Start of unicode area Basic Latin
//
static GUI_CONST_STORAGE unsigned char acGUI_FontArial13_4bpp_0041[45] = { // Code
    0x00, 0x05, 0xF5, 0x00, 0x00,
    0x00, 0x0A, 0xAA, 0x00, 0x00,
    0x00, 0x0E, 0x1E, 0x00, 0x00,
    0x00, 0x5B, 0x0B, 0x50, 0x00,
    0x00, 0xA6, 0x06, 0xA0, 0x00,
    0x00, 0xFF, 0xFF, 0xF0, 0x00,
    0x04, 0xB0, 0x00, 0xB4, 0x00,
    0x0A, 0x50, 0x00, 0x5A, 0x00,

```



```

    0x0D, 0x00, 0x00, 0x0D, 0x00,
};

static GUI_CONST_STORAGE GUI_CHARINFO_EXT GUI_FontArial13_4bpp_CharInfo[1] = {
    { 9, 9, -1, 2, 7, acGUI_FontArial13_4bpp_0041 }, // Code
    0041, LATIN CAPITAL LETTER A
};

static GUI_CONST_STORAGE GUI_FONT_PROP_EXT GUI_FontArial13_4bpp_Prop1 = {
    0x0041, // First character
    0x0041, // Last character
    &GUI_FontArial13_4bpp_CharInfo[0], // Address of first character
    (GUI_CONST_STORAGE GUI_FONT_PROP_EXT *)0, // Pointer to next GUI_FONT_PROP_EXT
};

GUI_CONST_STORAGE GUI_FONT GUI_FontArial13_4bpp = {
    GUI_FONTTYPE_PROP_AA4_EXT, // Type of font
    13, // Height of font
    13, // Vertical space of font
    1, // Magnification in X
    1, // Magnification in Y
    {&GUI_FontArial13_4bpp_Prop1}, // Pointer to first block
    11, // Baseline
    16, // Height of lowercase characters
    22, // Height of capital characters
};

/***** End of file *****/

```

## 9.5 emWinSPY

emWinSPY is designed for showing runtime information of the embedded target on a PC. It shows information about the currently connected emWin application like memory status, a tree with detailed information about all currently existing windows and a list of user input, which optionally can be written into a log file. Further it is able to take screenshots of the current screen. Communication works via a socket connection (TCP/IP) or Segger's Real Time Transfer (RTT), a technology explained in detail on [our website](#).

Window	Handle	x0	y0	Width	Height	Visbl.	Trans	MDev	Enbl.
▼ (Desktop)	2	0	0	16383	16383	■	-	-	■
▼ (Window)	3	0	0	800	480	■	-	-	■
TEXT	1	490	50	256	64	■	■	-	■
TEXT	6	490	100	252	32	■	■	-	■
WINDOW	9	60	60	360	360	■	-	-	■
TEXT	15	158	183	158	106	■	■	-	■
TEXT	17	208	273	72	22	■	■	-	■
BUTTON	19	510	150	230	50	■	■	-	-
BUTTON	20	510	205	230	50	■	■	-	■
BUTTON	21	510	260	230	50	■	■	-	-
BUTTON	22	510	345	230	70	■	■	-	-
▼ WINDOW	18	800	180	250	175	■	■	-	-
BUTTON	25	820	290	40	40	■	■	-	-
BUTTON	27	880	290	40	40	■	■	-	-
GAUGE	29	15	15	450	450	■	■	-	■

Type	Time	Content
PID	4846	x:510, y:150, Layer:0, DOWN
PID	4910	x:510, y:150, Layer:0, UP
PID	5996	x:510, y:205, Layer:0, DOWN
PID	6059	x:510, y:205, Layer:0, UP
PID	7665	x:510, y:345, Layer:0, DOWN
PID	7728	x:510, y:345, Layer:0, UP
PID	18925	x:784, y:15, Layer:0, UP
PID	25878	x:520, y:290, Layer:0, DOWN
PID	25971	x:520, y:290, Layer:0, UP
PID	33099	x:510, y:205, Layer:0, DOWN
PID	33163	x:510, y:205, Layer:0, UP
PID	34297	x:510, y:260, Layer:0, DOWN
PID	34359	x:510, y:260, Layer:0, UP
PID	35455	x:510, y:150, Layer:0, DOWN
PID	35517	x:510, y:150, Layer:0, UP
PID	36614	x:510, y:205, Layer:0, DOWN
PID	36678	x:510, y:205, Layer:0, UP
PID	38280	x:510, y:345, Layer:0, DOWN
PID	38343	x:510, y:345, Layer:0, UP

### 9.5.1 Introduction

The emWinSPY consists of two types of components: A server on application side, which is responsible for supplying data, and the emWinSPY viewer, which requests and shows that data. Server and viewer may be on different machines and on different architectures. The communication between server and viewer could be achieved via a socket connection (TCP/IP) or via Segger's Real Time Transfer (RTT). RTT is a technology for interactive user I/O in embedded applications.

#### 9.5.1.1 Requirements

##### RTT

If a J-Link debug probe and RTT is available on the used system, the communication could be achieved over an RTT connection. To be able to use RTT the free available RTT-code needs to be added to the project, which is available on our website:

[www.segger.com/jlink-rtt.html](http://www.segger.com/jlink-rtt.html)

##### TCP/IP stack

Alternatively the communication between server and viewer could be achieved by a socket connection. In that case a TCP/IP stack is required. In the Win32 simulation environment, TCP/IP (Winsock) is normally present. On the target hardware a TCP/IP stack needs to be present. The TCP/IP stack is NOT part of emWin. The flexible interface ensures that any TCP/IP stack can be used.

## Multi tasking

The emWinSPY server needs to run as a separate thread. Therefore a multi tasking system is required.

## Compile-time configuration

Support for emWinSPY needs to be enabled using the following definition in GUIConf.h:

```
#define GUI_SUPPORT_SPY 1
```

### 9.5.1.2 Availability

Currently emWinSPY (server and viewer) is part of the basic package. It is also available in the emWin simulation and trial version.

## 9.5.2 Starting the emWinSPY server...

### 9.5.2.1 ...in the simulation environment

The only thing to be done here is calling `GUI_SPY_StartServer()`. In the simulation environment that function automatically starts an emWinSPY server thread which waits on port 2468 for an incoming connection.

### 9.5.2.2 ...on the target hardware

Starting the server on the target hardware works exactly the same as in the simulation by calling `GUI_SPY_StartServer()`. But whereas the simulation already contains a routine for starting the server, that routine needs to be supplied by the application on hardware side. The routine to be added is `GUI_SPY_X_StartServer()`.

### 9.5.2.3 GUI\_SPY\_X\_StartServer

The challenge of the routine is creating a task which executes the actual server `GUI_SPY_Process()`. The way how that could be achieved depends on the used communication method.

#### Example

emWin comes with a ready to use sample for that function. It could be found in the sample folder: `Sample\GUI_X\GUI_SPY_X_StartServer.c`.

That sample contains a ready to use implementation to be used with JLink RTT and/or embOS/IP. It is easily adaptable to any IP-stack and any RTOS.

#### Prototype

```
int GUI_SPY_X_StartServer(void);
```

## 9.5.3 The emWinSPY viewer

### 9.5.3.1 The screen

The screen of the viewer is divided into 4 areas:

Area	Description
Status	Major purpose is showing the current state of memory allocation.
History	History of memory allocation.
Windows	Shows a tree of all existing windows.
Input	List of user interface input: Keyboard, Touch and MTouch

### 9.5.3.1.1 Status area

Status	
GUI-Version:	6.10
Total bytes:	2097152
Free bytes:	2085944
Dynamic bytes:	2089236
Used bytes:	3280
Fixed bytes:	7916
Peak:	20196
Max layers:	1
Used layers:	1
Max tasks:	4

The table below shows the information of the status area:

Item	Description
GUI-Version	Used GUI-Version of emWin application
Total bytes	Total bytes of memory available for emWin
Free bytes	Remaining free bytes
Dynamic bytes	Number of bytes currently allocated dynamically
Fixed bytes	Number of bytes used by fixed allocation
Peak	Maximum number of bytes used (fixed + dynamic)
Max layers	Maximum number of layers configured by GUI_NUM_LAYERS
Used layers	Number of layers used with current configuration.
Max tasks	Maximum number of GUI-tasks

### Fixed bytes / Dynamic bytes



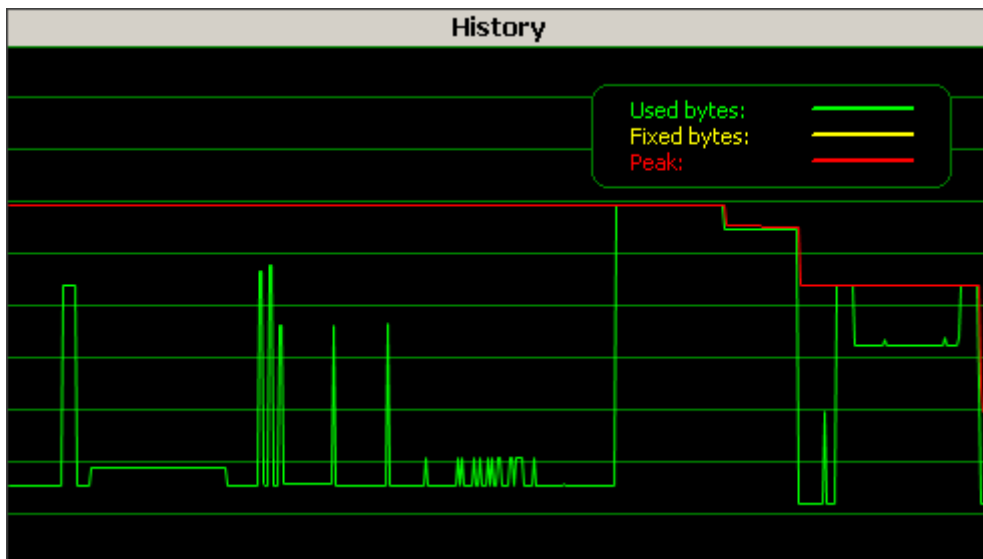

The memory management of emWin uses 2 kinds of memory allocation: dynamic allocated memory and fixed blocks. Dynamically allocated memory can be freed and reused for further dynamic allocation operations. A fixed memory block is no longer available for dynamic memory allocation. Once a fixed memory block is allocated, that block could not be used for dynamic allocation. Examples for fixed memory blocks are driver caches or conversion buffers.

### 9.5.3.1.2 History area



It shows the changes of used bytes, fixed bytes and memory peak in the course of time. The history remains after disconnecting and reconnecting. A context menu available with a right click allows clearing the history.

### 9.5.3.1.3 Windows area

Windows										
Window	Handle	x0	y0	Width	Height	Visbl.	Trans	MDev	Enbl.	
 (Desktop)	2	0	0	16383	16383	■	-	■	■	
 FRAMEWIN	5	240	179	80	61	■	-	-	■	
 FRAMEWIN-CLIENT	6	245	192	70	44	■	-	■	■	
BUTTON	4	247	216	32	20	■	■	■	■	
BUTTON	10	281	216	32	20	■	■	■	■	
PROGBAR	12	247	203	66	12	■	-	■	■	
TEXT	14	247	194	69	7	■	■	■	■	
 FRAMEWIN	16	160	0	160	65	-	-	-	■	
 FRAMEWIN-CLIENT	17	165	13	150	48	■	-	■	■	
TEXT	19	168	16	150	48	■	■	■	■	

That screen contains a tree of all currently existing windows with some additional information about their current states. The following table shows the available information:

Column	Description
Window	Type of window.
Handle	The handle of the window.
x0/y0	Position of the window in screen coordinates.
Width/Height	Size of the window.
Visbl.	Shows if the window (and its children) is visible or not.
Trans	Transparency flag of the window.
MDev	Shows if automatic use of memory devices is enabled for that window.
Enbl.	Shows if the window is enabled or disabled.

### 9.5.3.1.4 Input area

Input		
Type	Time	Content
PID	25873	x:65, y:125, Layer:0, DOWN
PID	27376	x:155, y:150, Layer:0, UP
PID	27676	x:155, y:150, Layer:0, DOWN
KEY	28678	Key:17, UP
KEY	28728	Key:17, DOWN
KEY	28778	Key:17, UP
KEY	28828	Key:17, DOWN
KEY	28878	Key:17, UP
KEY	28928	Key:17, DOWN
KEY	28978	Key:17, UP
KEY	29028	Key:17, DOWN
KEY	29078	Key:13, UP
KEY	29131	Key:13, DOWN
PID	29681	x:65, y:100, Layer:0, UP
PID	29981	x:65, y:100, Layer:0, DOWN
MTOUCH	30621	(x:187, y:57, Id:12, MOVE), (x:239, y:139, Id:13, DOWN), Layer:0
PID	30621	x:187, y:57, Layer:0, UP
MTOUCH	30628	(x:187, y:57, Id:12, MOVE), (x:239, y:139, Id:13, MOVE), Layer:0
PID	30628	x:187, y:57, Layer:0, UP

That window shows the user interface input recognized by emWinSPY. The following table shows the available information:

Column	Description
Type	PID: Pointer interface input KEY: Keyboard input MTOUCH: MultiTouch input
Time	Timestamp created on target side
Content	PID: X- and Y-position, Layer, UP or DOWN KEY: Keycode and UP or DOWN MTOUCH: X- and Y-position, TP-Id and DOWN, MOVE or UP for each TP (TP: Touchpoint)

### 9.5.3.2 Connecting to target

The connection parameters to be entered depend on the choice of communication.

#### Connecting via TCP/IP

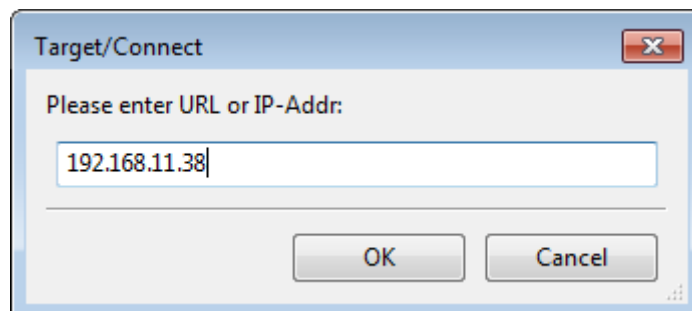

An URL or an IP-address could be used here. emWinSPY remembers the last used URL for the next connection.

### Connecting via RTT

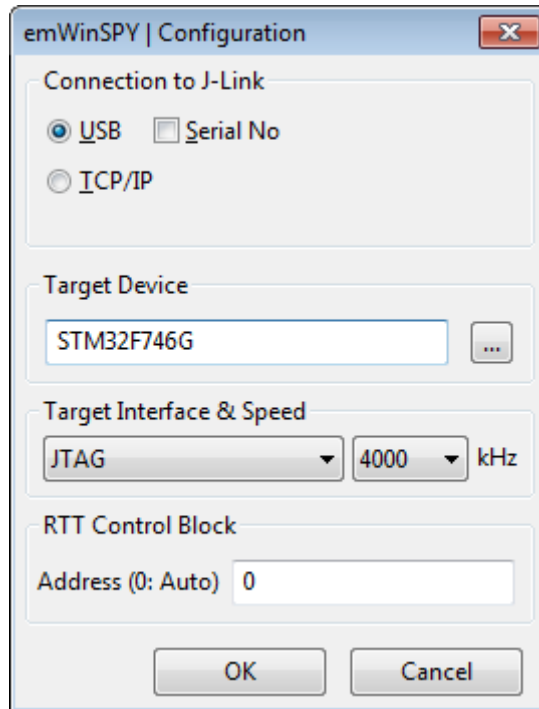

That dialog is required to enter the according parameters for an RTT connection. emWinSPY remembers the parameters for a further connection.

### 9.5.3.3 Configuration options

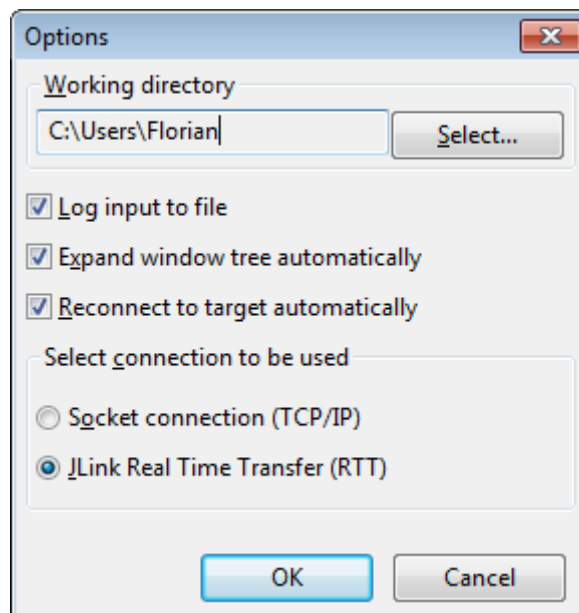

#### 'Working directory'

That folder is used for LOG-files and screenshots. The default value is the home directory of the current user.

#### 'Log input to file'

If logging is activated (default), all user interface input is written into a file. The filename is created automatically by using the current local time of the PC. The format is `YYYY_MM_DD_HH_MM_SS_MSEC.log`. For example `2014_12_16_15_04_44_0943.log` means the file was created at 12/2014 at 16:15 and 4 seconds. The last 4 digits contain the milliseconds. Each

time a connection is closed (or aborted) the file is be closed and a new one is created once the connection is established again.

### 'Expand window tree automatically'

If that option is active the nodes of the windows tree are automatically expanded.

### Reconnect to target automatically

If activated emWinSPY automatically tries to reconnect to a target after the connection has been closed.

### Select connection to be used

Select between RTT and socket connection.

## 9.5.3.4 Taking a screenshot from the target

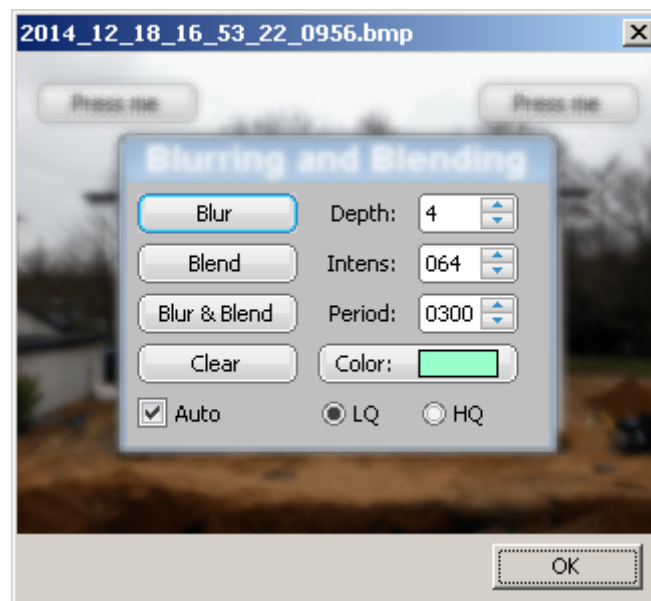

With the command **Target → Get screenshot** or by pressing **<CTRL> + <G>** a BMP-file containing the current content of the screen is created. The name of the file is created automatically by the same way as described under *Log input to file* above. Only the file extension is `.bmp` instead of `.log`. The screenshot can be found in the working directory.

## 9.5.4 emWinSPY API

The following table lists the emWinSPY related API functions.

Routine	Description
<code>GUI_SPY_Process()</code>	Actual emWinSPY-server to be called from the server thread.
<code>GUI_SPY_SetMemHandler()</code>	This function may be used to set a memory handler for the emWinSPY.
<code>GUI_SPY_StartServer()</code>	Starts the server thread by calling <code>GUI_SPY_X_StartServer()</code> .
<code>GUI_SPY_StartServerEx()</code>	Starts the server thread by calling the given function pointer.
<code>GUI_SPY_X_StartServer()</code>	Responsible for creating the actual server thread, establishing connections and calling <code>GUI_SPY_Process()</code> from the server thread.



### 9.5.4.1 GUI\_SPY\_Process()

#### Description

That function is the actual server which supplies the emWinSPY with the requested information. Simply call that function from the server thread after establishing a connection.

#### Prototype

```
int GUI_SPY_Process(GUI_tSend  pfSend,
                   GUI_tRecv  pfRecv,
                   void        * pConnectInfo);
```

#### Parameters

Parameter	Description
<code>pfSend</code>	Pointer to the function to be used by the server to send data to the emWinSPY.
<code>pfRecv</code>	Pointer to the function to be used by the server to read data from the emWinSPY.
<code>pConnectInfo</code>	Pointer to be passed to the send and receive function.

#### Return value

0        after the connection has been closed properly.  
1        on error.

#### Additional information

The sample folder `Sample\GUI_X` contains a sample implementation of a server thread. It is located in the file `GUI_SPY_X_StartServer.c`.

#### Example

```
static int _Send(const U8 * buf, int len, void * p) {
    ...
}
static int _Recv(U8 * buf, int len, void * p) {
    ...
}
static int _ServerTask(void * p) {
    int Sock;
    ...
    GUI_SPY_Process(_Send, _Recv, (void *)Sock);
}
```

### 9.5.4.2 GUI\_SPY\_SetMemHandler()

#### Description

This function may be used to set a memory handler for the emWinSPY. Some operations, especially collecting the windows information requires dynamic memory. That memory normally is allocated by using the emWin memory management system. With a separate memory manager (for example malloc and free) the server thread would not affect the dynamic memory manager.

#### Prototype

```
void GUI_SPY_SetMemHandler(void * ( *pMalloc)(unsigned int ),  
                           void   ( *pFree)(void * ));
```

#### Parameters

Parameter	Description
<code>pMalloc</code>	Pointer to memory allocation routine.
<code>pFree</code>	Pointer to memory release function.

#### Additional information

Using a separate memory manager is optional and not required.

### 9.5.4.3 GUI\_SPY\_StartServer()

#### Description

That function starts the server by calling `GUI_SPY_X_StartServer()` explained later and sets the required hook functions for gathering information.

#### Prototype

```
int GUI_SPY_StartServer(void);
```

#### Return value

0	on success
1	on error.

### 9.5.4.4 GUI\_SPY\_StartServerEx()

#### Description

This function starts the server by calling the function pointer passed to this function. With this function emWinSPY can be used, although GUI\_SUPPORT\_SPY is set to zero.

#### Prototype

```
int GUI_SPY_StartServerEx(int (*pGUI_SPY_X_StartServer)());
```

#### Parameters

Parameter	Description
<code>pGUI_SPY_X_StartServer</code>	Pointer to a function which starts the SPY server. Same as <code>GUI_SPY_X_StartServer()</code> .

#### Return value

- 0 on success
- 1 on error.

### 9.5.4.5 GUI\_SPY\_X\_StartServer()

#### Description

That function actually is responsible for creating the server thread and establishing a connection. When running the simulation it already contains an implementation of that function. When running on hardware that function has to be supplied by the customer.

#### Prototype

```
int GUI_SPY_X_StartServer(void);
```

#### Return value

0        on success  
1        on error.

#### Additional information

As already mentioned earlier the sample folder `Sample\GUI_X` contains a sample implementation of a server thread. It is located in the file `GUI_SPY_X_StartServer.c` and is written to be used with embOS/IP. In case of using different tools it should be an easy task to adapt that sample.

## 9.6 emWin4Web

emWin4Web is a command line tool for easily compiling emWin and AppWizard applications with Emscripten.



```

Command Prompt
usage: emwin4web [-h] [--version] [-s [<SETTING>=<VALUE> ...]] [-a] [-n <OUTPUT_NAME>] [-o <OUTPUT_DIR>] [-w]
               [-c <COLOR_CONVERSION>] [-d <XSIZE> <YSIZE>] [-i <EMWIN_COMPONENT> [<EMWIN_COMPONENT> ...]] [-R] [-S]
               [-r] [-D <DEFINE[=VALUE]> [<DEFINE[=VALUE]> ...]] [-p <SHELLPAGE_FILE>]
               [[<INPUT>] ...]

emWin4Web V6.46a -- A tool for compiling emWin with Emscripten for web browsers

Positional Arguments:
  [<INPUT>]          input for the build: can be C files, directories, AppWizard projects or previously generated
                    HTML files

General Information:
  -h, --help        show this help message and exit
  --version         show program's version number and exit

Global Options:
  -s [<SETTING>=<VALUE> ...], --setting [<SETTING>=<VALUE> ...]
                    set a global setting, or lists all settings if no parameters are given

Output Options:
  -a, --standalone  generates a standalone HTML file
  -n <OUTPUT_NAME>, --output-name <OUTPUT_NAME>
                    name of the output HTML file
  -o <OUTPUT_DIR>, --output-dir <OUTPUT_DIR>
                    output directory of the build
  -w, --webserver   launches a local web server and opens the output executable

emWin Build Options:
  -c <COLOR_CONVERSION>, --color-conv <COLOR_CONVERSION>
                    color conversion of the application
  -d <XSIZE> <YSIZE>, --display-size <XSIZE> <YSIZE>
                    display size of the application
  -i <EMWIN_COMPONENT> [<EMWIN_COMPONENT> ...], --ignore <EMWIN_COMPONENT> [<EMWIN_COMPONENT> ...]
                    ignore specific emWin subdirectories in the build
  -R, --round       will simulate a round display, is ignored when <XSIZE> != <YSIZE>
  -S, --svg         enables SVG support for the application

General Build Options:
  -r, --rebuild     force a rebuild and clean up any previous build files
  -D <DEFINE[=VALUE]> [<DEFINE[=VALUE]> ...], --define <DEFINE[=VALUE]> [<DEFINE[=VALUE]> ...]
                    add C preprocessor definitions

Miscellaneous Options:
  -p <SHELLPAGE_FILE>, --shellpage <SHELLPAGE_FILE>
                    set a custom shellpage HTML file to be used

```

## 9.6.1 Installation

The following chapter shows all required steps to correctly install and configure emWin4Web.

### 9.6.1.1 Prerequisites

#### Required Operating System

emWin4Web can be run on Microsoft Windows 10 (or higher).

#### Dependencies

Before installing emWin4Web, it should be made sure of that the following tools are all properly installed and are present in the system's PATH variable.

Tool	Version	Purpose
CMake	3.20 or higher	Meta-build system that is used for the build process.
Ninja	1.10 or higher	Ninja is used as a generator for CMake.
Python	3.6 or higher	Required to run Emscripten.
SEGGER AppWizard	1.50 or higher	Required for compiling AppWizard projects.
Git	<i>any modern version</i>	Recommended for cloning repositories, but not required.

### 9.6.1.1.1 Installing the Prerequisites on Windows

#### Installing CMake

Download the latest release from the [CMake website](#) and install it.  
You may also use a package manager like WinGet to install CMake.

```
winget install cmake
```

#### Installing Ninja

To install Ninja, download the latest release executable from [GitHub](#). Then, move the executable to a path that is accessible from command line.  
You may also use a package manager like WinGet to install Ninja.

```
winget install Ninja-build.Ninja
```

#### Installing Python

Make sure Python 3.6 or higher is installed, this is a requirement by Emscripten since its core driver is a Python script. You can find the latest Python release [here](#).  
You may also use a package manager like WinGet to install Python.

```
winget install python
```

#### Installing AppWizard

To compile AppWizard projects with emWin4Web the tool AppWizard also has to be installed. Required is AppWizard version 1.50 or higher.  
You can find the AppWizard installer in your emWin shipment in the `Tool` directory or you can download the demo version [on our website](#).  
Run the installer and verify that everything has been correctly installed by opening the tool. The `.AppWizard` extension needs to be associated with AppWizard which the installer will have done automatically.

#### Installing Git (optional)

Git is not required to run emWin4Web, but it is recommended for cloning the required third-party repositories that emWin4Web depends on. You can find the latest Git release on [git-scm.com](#).  
You may also use a package manager like WinGet to install Git.

```
winget install Git.Git
```

Instead of using Git, the third-party repositories that are described in detail later on can also be downloaded directly from GitHub.

#### Verifying the tool installation

Verify that all tools have been correctly installed and are working properly:

```
cmake --version  
ninja --version  
py --version  
git --version
```

Verify that the `.AppWizard` file extension is associated with the version you have just installed by opening a project.



## 9.6.1.2 Installing emWin4Web

### Installation on Windows

Run the installer and install the tool in a directory of your choosing.

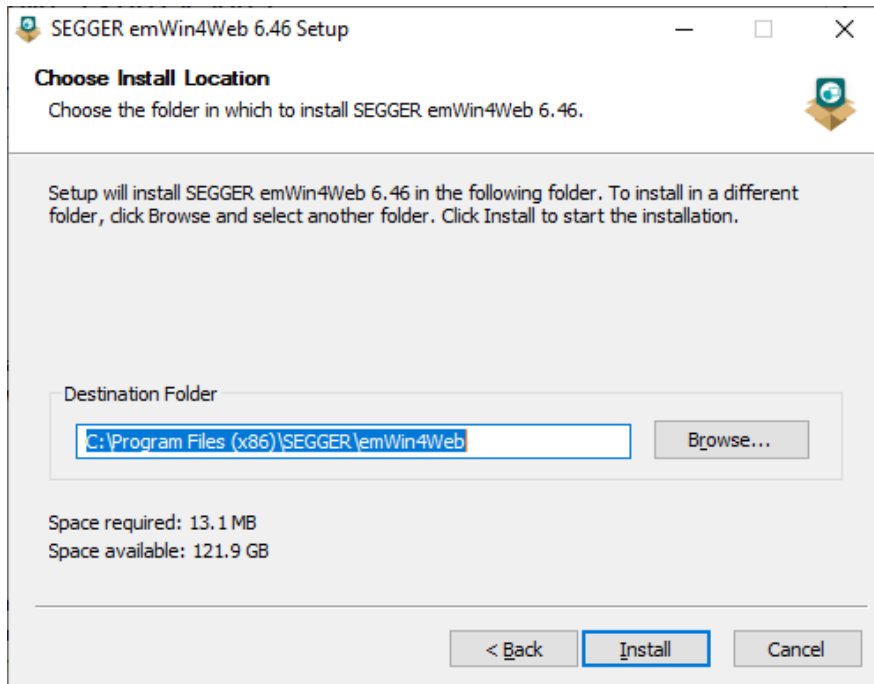

Optionally, you can check the option “Add emWin4Web to system PATH”. This will add the installation directory to the system’s PATH environment variable to be able to call `emwin4web` from anywhere.

### Verifying the installation

You can verify the successful installation of emWin4Web on your system by running this command:

```
emwin4web --version
```

Now, the configuration steps described in the next chapter need to be executed in order for emWin4Web to be usable.

### 9.6.1.3 Configuring emWin4Web

#### Setting up the emWin base directory

After the tool has been installed, a required configuration step is telling the tool where it finds the emWin sources. This is done as shown below. The path should point to the main /GUI directory.

```
emwin4web -s EMWIN_PATH=<your_emwin_path_here>
```

**Note:** The emWin base directory has to have its CMake scripts, otherwise this step will fail and it won't be possible to use emWin4Web.

#### Setting up the Emscripten SDK

Go to a directory of your choosing where the Emscripten SDK should be copied to.

```
cd <your_emscripten_path>
```

Then, clone the Emscripten repository from GitHub.

```
git clone https://github.com/emscripten-core/emsdk.git
```

Next, the file path to where the Emscripten SDK repository has been cloned needs to be set up in emWin4Web.

```
emwin4web -s EMSRIPTEN_PATH=<your_emscripten_path>
```

The rest of the installation steps of Emscripten do not need to be executed now as emWin4Web will install the downloaded Emscripten SDK automatically.

#### Setting up NanoVG (optional, only required for SVG)

If applications using emWin's SVG module are intended to be compiled, then the third-party library NanoVG also needs to be downloaded. More information about emWin's NanoVG SVG driver can be found under `GUI_SVG_DRIVER_NANOVG`, also make note of any limitations of this driver.

NanoVG is licensed under the [zlib license](#).

Go to a directory of your choosing where NanoVG should be copied to.

```
cd <your_nanovg_path>
```

Then, clone the NanoVG repository from Git. If Git is not available, download the repository content from GitHub.

```
git clone https://github.com/memononen/nanovg.git
```

Next, the file path to where the NanoVG repository has been cloned needs to be set up in emWin4Web.

```
emwin4web -s NANOVG_PATH=<your_nanovg_path>
```

## 9.6.2 Compiling an application

The code you want to compile has to be passed as the first arguments to the tool.

Accepted inputs for compilation are the following:

- C/C++ source and header files (can be multiple)
- Directories containing C/C++ source and header files (can be multiple)
- AppWizard projects (only on Windows)

Please note that any directory paths will not be compiled recursively.

### Configuring the application

Each application has its own properties, such as display size, color conversion, display shape, etc. These properties can be set with the corresponding command line options which are listed in detail at the end of this chapter.

Below is an example command that explicitly specifies the display size and color conversion.

```
emwin4web C:/Work/MyApp.c --display-size 800 480 --color-conv GUICC_M8888I -w
```

### Application limitations

Any features that may be unsupported or caveats can be found in the chapter Emscripten support.

### Choosing the output format

emWin4Web can generate output in two formats:

- HTML, JavaScript and WebAssembly: This is the default and separates everything into three files. A webserver is **required** to run it.
- HTML: Standalone HTML has the JavaScript and WebAssembly embedded in it and does **not require** a webserver to run it. It can be generated by passing `--standalone` or `-a` when compiling an application.

## 9.6.3 Running an application

### Running standalone HTML

In case the application was generated as standalone using the `--standalone` option, the generated HTML can be opened offline in a browser.

### Running the generated HTML, JavaScript and WebAssembly

The generated HTML, JavaScript and WebAssembly files have to be hosted on a web server in order to run correctly.

These generated files are not suitable for opening locally. This is because for security reasons, modern browsers don't allow loading WebAssembly or scripts on the `file:///` protocol.

emWin4Web makes this easy, simply pass the `-w` option (or `--webserver`) to the command line. When the build has finished a local web server will be hosted and the generated HTML page will be opened automatically. To close the webserver, press `CTRL + C`.

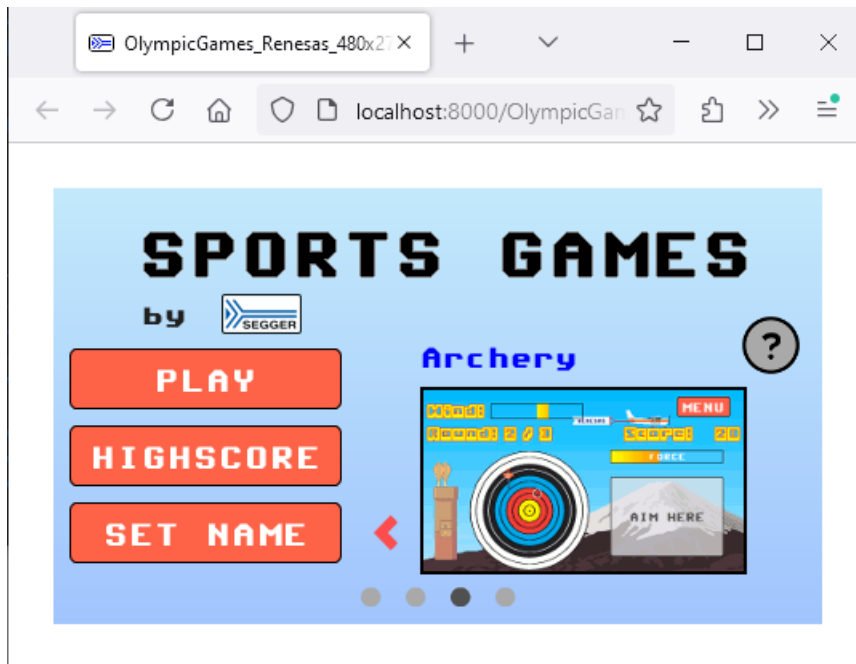

### Opening previously generated applications

To easily open a previously generated application, the HTML can be passed to emWin4Web. A local web server will be started and the given file will be opened.

```
emwin4web C:/Work/MyApp.html
```

## 9.6.4 Command line options

Below listed are all command line options of emWin4Web.

The command line arguments follow the [POSIX Conventions for Command Line Arguments](#). In essence, this means that

- a given flag is synonymous to its argument (e.g. `-h` is the same as `--help`)
- multiple flags without parameters can be put together (e.g. `-abc` is the same as `-a -b -c`)

Flag	Argument	Parameters	Description
Positional arguments			
		<INPUT> [ <INPUT> ... ]	<p><b>*.c *.h *.cc *.hh *.cpp *.hpp *.cxx *.hxx files</b> C/C++ source and header files for the build.</p> <p><b>Directories</b> Directories containing C/C++ source and header files for the build. Any directory will also be used as an include directory. The directory won't be searched recursively.</p> <p><b>*.AppWizard files</b> AppWizard project to be compiled (only on Windows).</p> <p><b>*.html files</b> A previously generated HTML file will be hosted on a local web server and opened.</p>
General information			
-h	--help		Shows the help text and exits.
	--version		Shows the program's version and exits.
Global options			
-s	--setting	[ <SETTING>=<VALUE> ... ]	If parameters are supplied, the given settings are updated. If no parameters are given, all current settings are listed.
Output options			
-a	--standalone		Compiles a standalone HTML as output.
-n	--output-name	<OUTPUT_NAME>	Name for the output file(s).
-o	--output-dir	<OUTPUT_DIR>	Directory for the output file(s).
-w	--webserver		Starts a local webserver after the build has finished and opens the generated HTML file.
emWin build options			
-c	--color-conv	<COLOR_CONVERSION>	Sets the color conversion to be used for building this application.
-d	--display-size	<XSIZE> <YSIZE>	Sets the display size to be used for building this application.
-i	--ignore	<EMWIN_COMPONENT> [ <EMWIN_COMPONENT> ... ]	Ignores the given emWin subdirectories in the build. <code>DisplayDriver</code> is always ignored and <code>AppWizard</code> is only added for AppWizard projects.
-R	--round		For applications with round displays. This option is ignored when <code>&lt;DISPLAY_XSIZE&gt; ≠ &lt;DISPLAY_YSIZE&gt;</code>
-S	--svg		Has to be set if SVGs are used in the application to enable hardware-accelerated SVG support.

Flag	Argument	Parameters	Description
General build options			
-r	--rebuild		Forces a rebuild, cleans up previous build files before this build.
-D	--define	<DEFINE [=VALUE]> [<DEFINE [=VALUE]> ...]	Adds C preprocessor definitions to the build.
Miscellaneous options			
-p	--shellpage	<SHELLPAGE_FILE>	Sets a custom shellpage HTML file to be used for the output. More information about shellpages can be read below.

## 9.6.5 Global settings

emWin4Web keeps some global settings for more convenience and less required command line arguments. These settings contain mostly default values and the required paths. Below listed are all available settings and their default value.

These settings can be modified via the `-s` (or `--setting`) option, e.g.:

```
emwin4web -s DEFAULT_COLORCONV=GUICC_M8888I
```

It is also possible to set multiple settings at once:

```
emwin4web -s DEFAULT_XSIZE=800 DEFAULT_YSIZE=480
```

Setting	Default value	Description
DEFAULT_XSIZE	480	Default display xSize used when no display size is specified.
DEFAULT_YSIZE	272	Default display ySize used when no display size is specified.
DEFAULT_COLORCONV	GUICC_8888I	Default color conversion used for the application used when no color conversion is specified.
DEFAULT_OUTNAME	emWinDemo	Default name for the output files when no name is specified.
DEFAULT_OUTPATH	<i>See below.</i>	Default path where the output files will be copied to when no directory is specified.
EMWIN_PATH		Directory path to the emWin source code.
EMSCRIPTEN_PATH		Directory path to the Emscripten SDK.
NANOVG_PATH		Directory path to the NanoVG source code.
WEBSERVER_PORT	8000	Webserver port to be used.

To get an overview of the current state of all settings, simply run this command to get a listing of the settings file:

```
emwin4web -s
```

### DEFAULT\_OUTPATH

The `DEFAULT_OUTPATH` setting is automatically set to the following default value, based on the current operating system:

Operating System	Default output path
Microsoft Windows	C:/Users/<USER>/AppData/Local/SEGGER/emWin4Web/out

## 9.6.6 Customization options

### Custom HTML shellpages

Through the `--shellpage` command line option, it is possible to set a custom HTML shellpage to the compiled application.

A shellpage is the HTML structure that holds the WebAssembly application generated by Emscripten.

The shellpage can be as extensive or simple as desired, it only needs to be ensured that the following token is placed conveniently in the HTML.

```
{{{ SCRIPT }}}
```

This token will be replaced with the `<script>` element that loads the WebAssembly.

Furthermore, the shellpage should contain a `<canvas>` element. Below is a stripped-down example shellpage.

```
<html>
<body>
  <p id="output">
    <canvas id="canvas"></canvas>
  </p>
  <script>
    var canvas = document.getElementById('canvas');
    var Module = {
      print: function(text) {
        console.log(text);
      },
      printErr: function(text) {
        console.error(text);
      },
      canvas: (function() {
        return canvas;
      })(),
    };
    window.addEventListener("click", () => window.focus());
  </script>
  {{{ SCRIPT }}}
</body>
</html>
```

The [Emscripten documentation](#) also has a section on custom shell files.



## 9.6.7 License information

Below listed is license information of all the required and mentioned third-party tools.

### **CMake**

CMake is distributed under the OSI-approved BSD 3-clause License. Please see the `COPY-right.txt` of the release for details.

### **Ninja**

Ninja is distributed under the Apache License, Version 2.0. For more information, please refer to [apache.org/licenses](http://apache.org/licenses).

### **Emscripten**

Emscripten is distributed under the MIT License. For more information, please refer to [opensource.org](http://opensource.org).

### **Python**

Python is distributed under the Python Software Foundation License. For more information, please refer to [python.org](http://python.org).

### **Git**

Git is distributed under the GPL-2.0 License. For more information, please refer to [gnu.org](http://gnu.org).

# 9.7 GUI Builder

## Note

Since the release of the **AppWizard** tool, the GUI Builder is considered an **obsolete tool**. More information about AppWizard can be found in the chapter *AppWizard* on page 86.

The GUIBuilder application is a tool for creating dialogs without any knowledge of the C programming language. Instead of writing source code the widgets can be placed and sized by drag and drop. Additional properties can be added per context menu. Fine tuning can be done by editing the properties of the widgets. This does not require any knowledge of the C programming language. The dialogs can be saved as C files which can be enhanced by adding user defined code. Of course these C files with the embedded user code can be loaded and modified by the GUIBuilder.

## Screenshot

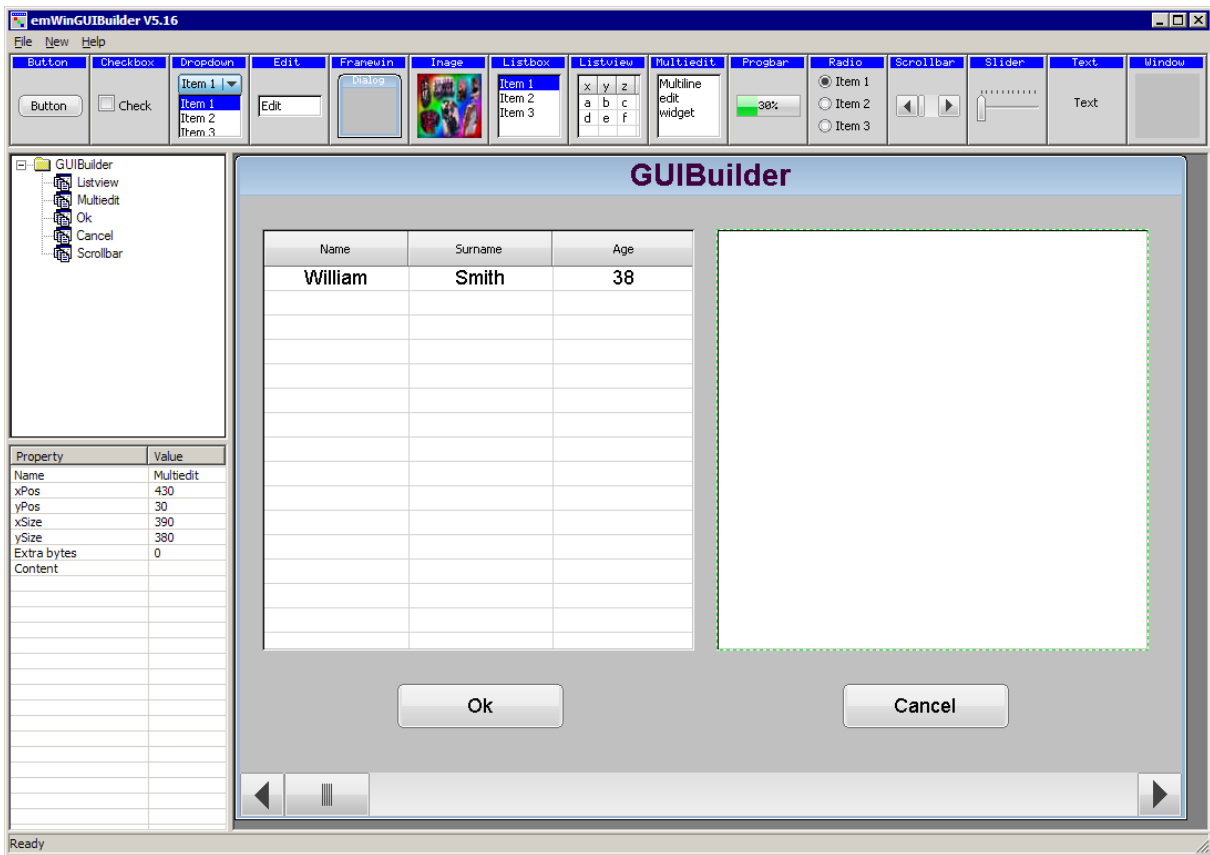

### 9.7.1 Introduction

The following diagram shows the elements of the graphical user interface of the GUIBuilder:

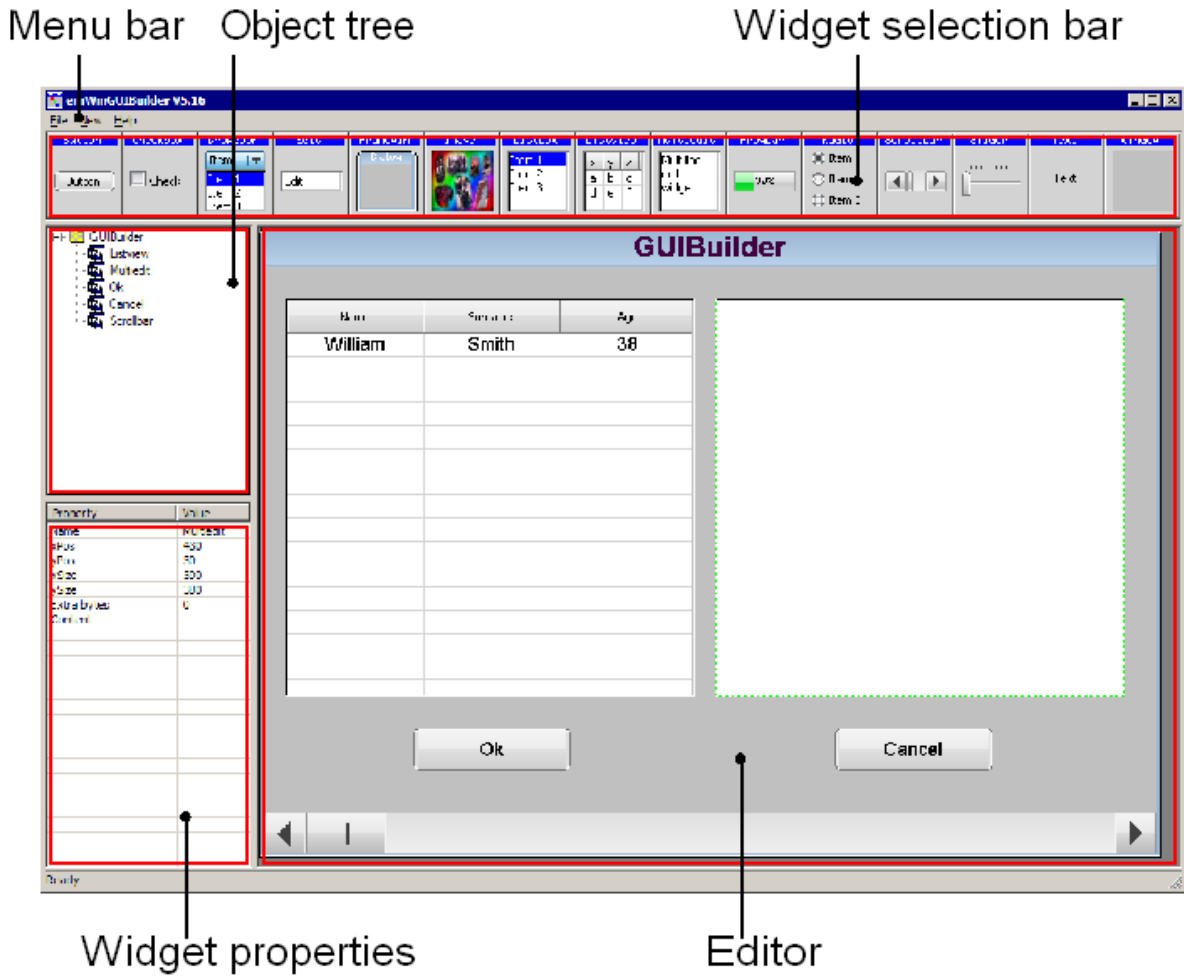

#### Widget selection bar

This bar contains all available widgets of the GUIBuilder. They can be added by a single click into the selection bar on the desired widget or by dragging them into the editor area.

#### Object tree

This area shows all currently loaded dialogs and their child widgets. It can be used for selecting a widget by clicking on the according entry.

#### Widget properties

It shows the properties of each widget and can be used for editing them.

#### Editor

The editor window shows the currently selected dialog. It can be used to place and resize the dialog and its widgets.

## 9.7.2 Getting started

Before starting a project, the GUIBuilder needs to know the project path. Per default this is the application path of the GUIBuilder. All files are saved in this folder.

### Setting up the project path

After the first execution, the GUIBuilder directory contains the configuration file GUIBuilder.ini. Within this file the project path can be changed by editing the value ProjectPath:



```
[Settings]
ProjectPath="C:
```

## 9.7.3 Creating a dialog

The following shows how to create a dialog and how to modify the properties of the used widgets.

### 9.7.3.1 Selecting a parent widget

Each dialog requires a valid parent widget. So it is required to start with a widget which is able to serve as a parent. Currently there are 2 widgets which can be used at this point:

Frame window widget	Window widget
	

The table above shows the according buttons of the widget selection bar. To get a widget into the editor the buttons can be single clicked, dragged with the mouse into the editor window or created by using the *New* menu.

### 9.7.3.2 Resizing and positioning in the editor

After placing a widget into the editor area it can be moved by using the mouse or the arrow keys of the keyboard. Resizing can be done by dragging the markers.

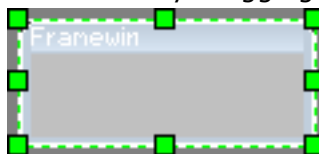

### 9.7.3.3 Modifying the widget properties

Property	Value
Name	Framewin
xPos	0
yPos	0
xSize	320
ySize	240
Extra bytes	0

The lower left area of the GUIBuilder contains the property window. After creating a new widget it shows the default properties of the widget: Name, position, size and extra bytes. These properties are available for all kinds of widgets and can not be removed. Contrary to the default properties all additional properties can be removed by the context menu or by pressing <DEL> when the according line is selected. To change a value it can be selected by the keyboard by pressing <ENTER> (if the desired line is selected and the window has the focus) or by single clicking into the value field. Further the 'Edit' entry of the context menu available with a right click can be used to start the edit operation. <ESC> can be used to abort the edit operation.

### 9.7.3.4 Adding additional functions to a widget

To get a context menu with the available functions for a widget either a right click in the editor window on the desired widget or a right click in the object tree can be done. Selecting a function adds a new property to the widget and starts the edit operation for the chosen function. In case of numerical or alpha numerical values the edit operation is done within the property window. In case of choosing fonts, text alignments or colors a separate selection window occurs.

#### Alignment selection

The alignment selection dialog shows the previous selected alignment in green. A single click within the box selects a new alignment. <ESC> aborts the selection.

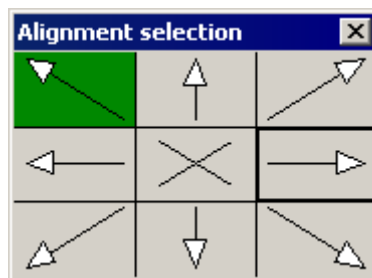

#### Color selection

For selecting a color the Windows default color selection dialog occurs. <ESC> aborts the selection.

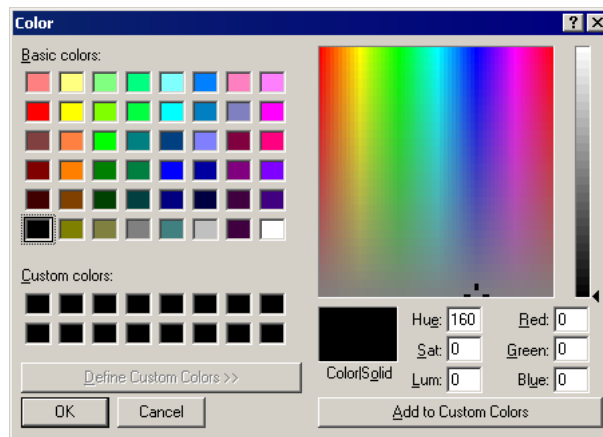

## Font selection

The font selection dialog shows all available fonts of the GUI Builder. The desired font can be selected by a single click on the desired font. <ESC> aborts the selection.

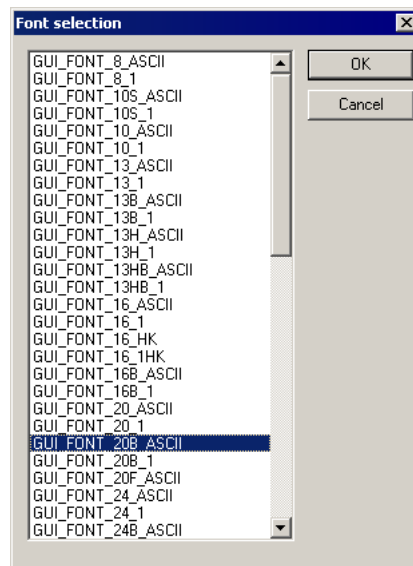

### 9.7.3.5 Deleting a widget property

This can be done easily by using the context menu of the property window or by pressing the <DEL> key if the desired property in the widget property window has the focus.

### 9.7.3.6 Deleting a widget

A widget can be deleted by pressing the <DEL> key if the widget is activated in the editor window. It can also be removed by selecting it in the object tree window and then pressing the <DEL> key. Deleting a widget automatically causes all of its child windows to be deleted as well.

### 9.7.3.7 Deleting a widget

A widget can be deleted by pressing the <DEL> key if the widget is activated in the editor window. It can also be removed by selecting it in the object tree window and then pressing the <DEL> key. Deleting a widget automatically causes all of its child windows to be deleted as well.

## 9.7.4 Saving the current dialog(s)

With the menu entry **File → Save...** all currently loaded dialogs will be saved in the project folder. Details on how to set up the project folder can be found in the section *Getting started* on page 3019.

Each dialog will be saved as a single C file. The file names are generated automatically by the name of the dialog root widget (FRAMEWIN or WINDOW widget). The file names are build as follows:

<Widget name>DLG.c If for example the name of the widget is *Framewin* the file will be named *FramewinDLG.c*.

## 9.7.5 Output of the GUIBuilder

As mentioned above the result of the GUIBuilder are C files only. The following shows a small sample which is generated by the tool:

```

/*****
 *
 *           SEGGER Microcontroller GmbH
 *     Solutions for real time microcontroller applications
 *
 *****/
 *
 *   C-file generated by:
 *
 *   GUI_Builder for emWin version 5.09
 *   Compiled Mar 23 2011, 09:52:04
 *   (c) 2011 Segger Microcontroller GmbH
 *
 *****/
 *
 *   Internet: www.segger.com Support: support@segger.com
 *
 *****/
 */
// USER START (Optionally insert additional includes)
// USER END
#include "DIALOG.h"
/*****
 *
 *   Defines
 *
 *****/
 */
#define ID_FRAMEWIN_0  (GUI_ID_USER + 0x0A)
#define ID_BUTTON_0    (GUI_ID_USER + 0x0B)
// USER START (Optionally insert additional defines)
// USER END
/*****
 *
 *   Static data
 *
 *****/
 */
// USER START (Optionally insert additional static data)
// USER END
/*****
 *
 *   _aDialogCreate
 */
static const GUI_WIDGET_CREATE_INFO _aDialogCreate[] = {
  { FRAMEWIN_CreateIndirect, "Framewin", ID_FRAMEWIN_0, 0, 0, 320, 240, 0, 0, 0 },
  { BUTTON_CreateIndirect, "Button", ID_BUTTON_0, 5, 5, 80, 20, 0, 0, 0 },
// USER START (Optionally insert additional widgets)
// USER END
};

```

```

/*****
 *
 *   Static code
 *
 *****/
// USER START (Optionally insert additional static code)
// USER END
/*****
 *
 *   _cbDialog
 */
static void _cbDialog(WM_MESSAGE * pMsg) {
    WM_HWIN hItem;
    int Id, NCode;
    // USER START (Optionally insert additional variables)
    // USER END
    switch (pMsg->MsgId) {
    case WM_INIT_DIALOG:
        //
        // Initialization of 'Framewin'
        //
        hItem = pMsg->hWin;
        FRAMEWIN_SetTextAlign(hItem, GUI_TA_HCENTER | GUI_TA_VCENTER);
        FRAMEWIN_SetFont(hItem, GUI_FONT_24_ASCII);
        //
        // Initialization of 'Button'
        //
        hItem = WM_GetDialogItem(pMsg->hWin, ID_BUTTON_0);
        BUTTON_SetText(hItem, "Press me...");
        // USER START (Opt. insert additional code for further widget initialization)
        // USER END
        break;
    case WM_NOTIFY_PARENT:
        Id = WM_GetId(pMsg->hWinSrc);
        NCode = pMsg->Data.v;
        switch(Id) {
        case ID_BUTTON_0: // Notifications sent by 'Button'
            switch(NCode) {
            case WM_NOTIFICATION_CLICKED:
                // USER START (Optionally insert code for reacting on notification message)
                // USER END
                break;
            case WM_NOTIFICATION_RELEASED:
                // USER START (Optionally insert code for reacting on notification message)
                // USER END
                break;
            // USER START (Opt. insert additional code for further notification handling)
            // USER END
            }
            break;
            // USER START (Optionally insert additional code for further IDs)
            // USER END
        }
        break;
        // USER START (Optionally insert additional message handling)
        // USER END
    default:
        WM_DefaultProc(pMsg);
        break;
    }
}
/*****
 *
 *   Public code
 *
 *****/
*/

```



```

/*****
*
*   CreateFramewin
*/
WM_HWIN CreateFramewin(void) {
    WM_HWIN hWin;
    hWin = GUI_CreateDialogBox(_aDialogCreate,
        GUI_COUNTOF(_aDialogCreate), _cbDialog, WM_HBKWIN, 0, 0);
    return hWin;
}
// USER START (Optionally insert additional public code)
// USER END
/***** End of file *****/

```

## 9.7.6 Modifying the C files

As the sample code shows, it contains many sections for custom code. These are the following sections:

```

// USER START (Optionally insert ...)
// USER END

```

The start and end lines may not be modified. They are required for the GUIBuilder to be able to distinguish between user code and generated code. The following shows how it should work:

```

// USER START (Optionally insert additional includes)
#ifndef WIN32
    #include <ioat91sam9261.h>
#endif
// USER END

```

## 9.7.7 How to use the C files

As the sample output shows, the code does not contain any code which uses the dialogs or with other words makes them visible on the display. Each file contains a creation routine at the end named `Create<Widget name>()`. These routines create the according dialog. Simply call these routines to make them occur on the display.

### Example

The following code shows how to draw the dialog of the previous output sample on a display:

```

#include "DIALOG.h"
/*****
*
*   Externals
*
*****
*/
WM_HWIN CreateFramewin(void);
/*****
*
*   Public code
*
*****
*/
/*****
*
*   MainTask
*/
void MainTask(void) {
    WM_HWIN hDlg;
    GUI_Init();
}

```

```
//  
// Call creation function for the dialog  
//  
hDlg = CreateFrameWin();  
//  
// May do anything with hDlg  
//  
...  
//  
// Keep program allive...  
//  
while (1) {  
    GUI_Delay(10);  
}  
}
```

# Chapter 10

## Execution Model: Single Task / Multitask

---

emWin has been designed from the beginning to be compatible with different types of environments. It works in single task and in multitask applications, with a proprietary operating system or with any commercial RTOS such as embOS or uC/OS.

## 10.1 Supported execution models

We have to basically distinguish between 3 different execution models:

### **Single task system (super loop)**

The entire program runs in one super loop. Normally, all software components are periodically called. Interrupts must be used for real time parts of the software since no real time kernel is used.

### **Multitask system: one task calling emWin**

A real time kernel (RTOS) is used, but only one task calls emWin functions. From the graphic software's point of view, it is the same as being used in a single task system.

### **Multitask system: multiple tasks calling emWin**

A real time kernel (RTOS) is used, and multiple tasks call emWin functions. This works without a problem as long as the software is made thread-safe, which is done by enabling multitask support in the configuration and adapting the kernel interface routines. For popular kernels, the kernel interface routines are readily available.

## 10.2 Single task system (super loop)

### 10.2.1 Description

The entire program runs in one super loop. Normally, all components of the software are periodically called. No real time kernel is used, so interrupts must be used for real time parts of the software. This type of system is primarily used in smaller systems or if real time behavior is not critical.

### 10.2.2 Superloop example (without emWin)

```
void main (void) {
    HARDWARE_Init();
    /* Init software components */
    XXX_Init();
    YYY_Init();
    /* Superloop: call all software components regularly */
    while (1) {
        /* Exec all components of the software */
        XXX_Exec();
        YYY_Exec();
    }
}
```

### 10.2.3 Advantages

No real time kernel is used (→ smaller ROM size, just one stack → less RAM for stacks), no preemption/synchronization problems.

### 10.2.4 Disadvantages

The super loop type of program can become hard to maintain if it exceeds a certain program size. Real time behavior is poor, since one software component cannot be interrupted by any other component (only by interrupts). This means that the reaction time of one software component depends on the execution time of all other components in the system.

### 10.2.5 Using emWin

There are no real restrictions regarding the use of emWin. As always, `GUI_Init()` has to be called before you can use the software. From there on, any API function can be used. If the Window Manager's callback mechanism is used, then an emWin update function has to be called regularly. This is typically done by calling the `GUI_Exec()` from within the super loop. Blocking functions such as `GUI_ExecDialog()` should not be used in the loop since they would block the other software modules. The default configuration, which does not support multitasking (`#define GUI_OS 0`) can be used; kernel interface routines are not required.

### 10.2.6 Superloop example (with emWin)

```
void main (void) {
    HARDWARE_Init();
    /* Init software components */
    XXX_Init();
    YYY_Init();
    GUI_Init();          /* Init emWin */
    /* Superloop: call all software components regularly */
    while (1) {
        /* Exec all components of the software */
        XXX_Exec();
        YYY_Exec();
        GUI_Exec();      /* Exec emWin for functionality like updating windows */
    }
}
```

```
}  
}
```

## 10.3 Multitask system: one task calling emWin

### 10.3.1 Description

A real time kernel (RTOS) is used. The user program is split into different parts, which execute in different tasks and typically have different priorities. Normally the real time critical tasks (which require a certain reaction time) will have the highest priorities. **One single task** is used for the user interface, which calls emWin functions. This task usually has the lowest priority in the system or at least one of the lowest (some statistical tasks or simple idle processing may have even lower priorities).

Interrupts can, but do not have to be used for real time parts of the software.

### 10.3.2 Advantages

The real time behavior of the system is excellent. The real time behavior of a task is affected only by tasks running at higher priority. This means that changes to a program component running in a low priority task do not affect the real time behavior at all. If the user interface is executed from a low priority task, this means that changes to the user interface do not affect the real time behavior. This kind of system makes it easy to assign different components of the software to different members of the development team, which can work to a high degree independently from each other.

### 10.3.3 Using emWin

If the Window Manager's callback mechanism is used, then an emWin update function (typically `GUI_Exec()`, `GUI_Delay()`) has to be called regularly from the task calling emWin. Since emWin is only called by one task, to emWin it is the same as being used in a single task system.

The default configuration, which does not support multitasking (`#define GUI_OS 0`) can be used; kernel interface routines are not required. You can use any real time kernel, commercial or proprietary.

## 10.4 Multitask system: multiple tasks calling emWin

### 10.4.1 Description

A real time kernel (RTOS) is used. The user program is split into different parts, which execute in different tasks with typically different priorities. Normally the real time critical tasks (which require a certain reaction time) will have the highest priorities. **Multiple tasks** are used for the user interface, calling emWin functions. These tasks typically have low priorities in the system, so they do not affect the real time behavior of the system. Interrupts can, but do not have to be used for real time parts of the software.

### 10.4.2 Advantages

The real time behavior of the system is excellent. The real time behavior of a task is affected only by tasks running at higher priority. This means that changes of a program component running in a low priority task do not affect the real time behavior at all. If the user interface is executed from a low priority task, this means that changes on the user interface do not affect the real time behavior. This kind of system makes it easy to assign different components of the software to different members of the development team, which can work to a high degree independently from each other.

### 10.4.3 Using emWin

If the Window Manager's callback mechanism is used, then an emWin update function (typically `GUI_Exec()`, `GUI_Delay()`) has to be called regularly from one or more tasks calling emWin.

The default configuration, which does not support multitasking (`#define GUI_OS 0`) can **NOT** be used. The configuration needs to enable multitasking support and define a maximum number of tasks from which emWin is called (excerpt from `GUIConf.h`):

```
#define GUI_OS      1      // Enable multitasking support
#define GUI_MAXTASK 5      // Max. number of tasks that may call emWin
```

Kernel interface routines are required, and need to match the kernel being used. You can use any real time kernel, commercial or proprietary. Both the macros and the routines are discussed in the following chapter sections.

### 10.4.4 Recommendations

- Call the emWin update functions (that is, `GUI_Exec()`, `GUI_Delay()`) from just one task. It will help to keep the program structure clear. If you have sufficient RAM in your system, dedicate one task (with the lowest priority) to updating emWin. This task will continuously call `GUI_Exec()` as shown in the example below and will do nothing else.
- Keep your real time tasks (which determine the behavior of your system with respect to I/O, interface, network, etc.) separate from tasks that call emWin. This will help to assure best real time performance.
- If possible, use only one task for your user interface. This helps to keep the program structure simple and simplifies debugging. (However, this is not required and may not be suitable in some systems.)

### 10.4.5 Example

This excerpt shows the dedicated emWin update task. It is taken from the example `MT_Multitasking`, which is included in the examples shipped with emWin:

```
/* *****
 *
 *      GUI background processing
 *
 * This task does the background processing.
 */
```



```
* The main job is to update invalid windows, but other things such as
* evaluating mouse or touch input may also be done.
*/
void GUI_Task(void) {
    while(1) {
        GUI_Exec();           /* Do the background work ... Update windows etc.) */
        GUI_X_ExecIdle();    /* Nothing left to do for the moment ... Idle
        processing */
    }
}
```

## 10.5 Configuration functions for multitasking support

The following table shows the configuration functions available for a multitask system with multiple tasks calling emWin:

<b>Routine</b>	<b>Description</b>
<code>GUI_SetSignalEventFunc()</code>	Sets a function that signals an event.
<code>GUI_SetWaitEventFunc()</code>	Sets a function which waits for an event.
<code>GUI_SetWaitEventTimedFunc()</code>	Defines a function which waits for an event for a dedicated period of time.
<code>GUI_WaitEvent()</code>	Sets emWin into wait state.

## 10.5.1 GUI\_SetSignalEventFunc()

### Description

Sets a function that signals an event.

### Prototype

```
void GUI_SetSignalEventFunc(GUI_SIGNAL_EVENT_FUNC pfSignalEvent);
```

### Parameters

Parameter	Description
<code>pfSignalEvent</code>	Pointer to a function that signals an event.

### Definition of GUI\_SIGNAL\_EVENT\_FUNC

```
typedef void (* GUI_SIGNAL_EVENT_FUNC)(void);
```

### Additional information

Per default the GUI needs to periodically check for events unless a function is defined which waits and one that triggers an event. This function sets the function which triggers an event. It makes only sense in combination with `GUI_SetWaitEventFunc()`, and `GUI_SetWaitEventTimedFunc()`. The advantage of using these functions instead of polling is the reduction of CPU load of the waiting task to 0% while it waits for input. If the function has been specified as recommended and the user gives the system any input (keyboard or pointer input device) the specified function should signal an event.

It is recommended to specify the function `GUI_X_SignalEvent()` for the job.

### Example

```
GUI_SetSignalEventFunc(GUI_X_SignalEvent);
```

## 10.5.2 GUI\_SetWaitEventFunc()

### Description

Sets a function which waits for an event.

### Prototype

```
void GUI_SetWaitEventFunc(GUI_WAIT_EVENT_FUNC pWaitEvent);
```

### Parameters

Parameter	Description
<code>pWaitEvent</code>	Pointer to a function that waits for an event.

### Definition of GUI\_SIGNAL\_EVENT\_FUNC

```
typedef void (* GUI_WAIT_EVENT_FUNC)(void);
```

### Additional information

Per default the GUI needs to periodically check for events unless a function is defined which waits and one that triggers an event. This function sets the function which waits for an event. Makes only sense in combination with `GUI_SetSignalEventFunc()` and `GUI_SetWaitEventTimedFunc()`. The advantage of using these functions instead of polling is the reduction of CPU load of the waiting task to 0% while it waits for input. If the function has been specified as recommended and the system waits for user input the defined function should wait for an event signaled from the function specified by `GUI_SetSignalEventFunc()`. It is recommended to specify the function `GUI_X_WaitEvent()` for the job.

### Example

```
GUI_SetWaitEventFunc(GUI_X_WaitEvent);
```

## 10.5.3 GUI\_SetWaitEventTimedFunc()

### Description

Defines a function which waits for an event for a dedicated period of time.

### Prototype

```
void GUI_SetWaitEventTimedFunc(GUI_WAIT_EVENT_TIMED_FUNC pfWaitEventTimed);
```

### Parameters

Parameter	Description
<code>pfWaitEventTimed</code>	Pointer to a function that waits for an event.

### Definition of GUI\_WAIT\_EVENT\_TIMED\_FUNC

```
typedef void (* GUI_WAIT_EVENT_TIMED_FUNC)(int Period);
```

Parameter	Description
<code>Period</code>	Period in ms to wait for an event.

### Additional information

Per default the GUI needs to periodically check for events unless a function is defined which waits and one that triggers an event. This function sets the function which waits for an event if a timer is active. Makes only sense in combination with `GUI_SetSignalEventFunc()` and `GUI_SetWaitEventFunc()`. If the function has been specified as recommended and the system waits for user input during a timer is active the defined function should wait until the timer expires or an event signaled from the function set by `GUI_SetSignalEventFunc()`. It is recommended to specify the function `GUI_X_WaitEventTimed()` for the job.

### Example

```
GUI_SetWaitEventTimedFunc(GUI_X_WaitEventTimed);
```

## 10.5.4 GUI\_WaitEvent()

### Description

Sets emWin into wait state. If an event gets signaled emWin will continue.

### Prototype

```
void GUI_WaitEvent(void);
```

### Additional information

This function is called to let emWin wait for an event which gets signaled by the function set by `GUI_SetWaitEventFunc()`.

### Example

```
if (!GUI_Exec()) {  
    GUI_WaitEvent();  
}
```

## 10.6 Configuration macros for multitasking support

The following table shows the configuration macros used for a multitask system with multiple tasks calling emWin:

Type	Macro	Default	Description
N	GUI_MAXTASK	4	Defines the maximum number of tasks from which emWin is called when multi-tasking support is enabled.
B	GUI_OS	0	Activate to enable multitasking support.
F	GUI_X_SIGNAL_EVENT	-	Defines a function that signals an event. (Obsolete)
F	GUI_X_WAIT_EVENT	GUI_X_ExecIdle	Defines a function that waits for an event. (Obsolete)
F	GUI_X_WAIT_EVENT_TIMED	-	Defines a function that waits for an event for a dedicated period of time. (Obsolete)

### 10.6.1 GUI\_MAXTASK

#### Description

Defines the maximum number of tasks from which emWin is called to access the display.

#### Type

Numerical value.

#### Additional information

This symbol is only relevant when `GUI_OS` is activated. If working with a pre-compiled library the function `GUI_TASK_SetMaxTask()` should be used instead. Further information can be found in the function description of `GUI_TASK_SetMaxTask` on page 120.

### 10.6.2 GUI\_OS

#### Description

Enables multitasking support by activating the module `GUI_Task`.

#### Type

Binary switch

- 0: inactive, multitask support disabled (default)
- 1: active, multitask support enabled

### 10.6.3 GUI\_X\_SIGNAL\_EVENT

#### Description

Defines a function that signals an event.

#### Type

Function replacement

#### Additional information

Per default the GUI needs to periodically check for events unless a function is defined which waits and one that triggers an event. This macro defines the function which triggers an event. It makes only sense in combination with `GUI_X_WAIT_EVENT`. The advantage of using

the macros `GUI_X_SIGNAL_EVENT` and `GUI_X_WAIT_EVENT` instead of polling is the reduction of CPU load of the waiting task to 0% while it waits for input. If the macro has been defined as recommended and the user gives the system any input (keyboard or pointer input device) the defined function should signal an event.

It is recommended to specify the function `GUI_X_SignalEvent()` for the job.

### Example

```
#define GUI_X_SIGNAL_EVENT GUI_X_SignalEvent
```

## 10.6.4 GUI\_X\_WAIT\_EVENT

### Description

Defines a function which waits for an event.

### Type

Function replacement

### Additional information

Per default the GUI needs to periodically check for events unless a function is defined which waits and one that triggers an event. This macro defines the function which waits for an event. Makes only sense in combination with `GUI_X_SIGNAL_EVENT`. The advantage of using the macros `GUI_X_SIGNAL_EVENT` and `GUI_X_WAIT_EVENT` instead of polling is the reduction of CPU load of the waiting task to 0% while it waits for input. If the macro has been defined as recommended and the system waits for user input the defined function should wait for an event signaled from the function defined by the macro `GUI_X_SIGNAL_EVENT`.

It is recommended to specify the function `GUI_X_WaitEvent()` for the job.

### Example

```
#define GUI_X_WAIT_EVENT GUI_X_WaitEvent
```

## 10.6.5 GUI\_X\_WAIT\_EVENT\_TIMED

### Description

Defines a function which waits for an event for a dedicated period of time.

### Type

Function replacement

### Additional information

Per default the GUI needs to periodically check for events unless a function is defined which waits and one that triggers an event. This macro defines the function which waits for an event if a timer is active. Makes only sense in combination with `GUI_X_SIGNAL_EVENT`. If the macro has been defined as recommended and the system waits for user input during a timer is active the defined function should wait until the timer expires or an event signaled from the function defined by the macro `GUI_X_SIGNAL_EVENT`.

It is recommended to specify the function `GUI_X_WaitEventTimed()` for the job.

### Example

```
#define GUI_X_WAIT_EVENT_TIMED GUI_X_WaitEventTimed
```



## 10.7 Kernel interface API

An RTOS usually offers a mechanism called a resource semaphore, in which a task using a particular resource claims that resource before actually using it. The display is an example of a resource that needs to be protected with a resource semaphore. emWin uses the macro `GUI_USE` to call the function `GUI_Use()` before it accesses the display or before it uses a critical internal data structure. In a similar way, it calls `GUI_Unuse()` after accessing the display or using the data structure. This is done in the module `GUITask.c`.

`GUITask.c` in turn uses the GUI kernel interface routines shown in the table below. These routines are prefixed `GUI_X_` since they are high-level (hardware-dependent) functions. They must be adapted to the real time kernel used in order to make the emWin task (or thread) safe. Detailed descriptions of the routines follow, as well as examples of how they are adapted for different kernels.

Routine	Description
<code>GUI_X_GetTaskId()</code>	Returns a unique ID for the current task.
<code>GUI_X_InitOS()</code>	Creates the resource semaphore or mutex typically used by <code>GUI_X_Lock()</code> and <code>GUI_X_Unlock()</code> .
<code>GUI_X_Lock()</code>	Locks the GUI.
<code>GUI_X_SignalEvent()</code>	Signals an event.
<code>GUI_X_Unlock()</code>	Unlocks the GUI.
<code>GUI_X_WaitEvent()</code>	Waits for an event.
<code>GUI_X_WaitEventTimed()</code>	Waits for an event for the given period.

## 10.7.1 GUI\_X\_GetTaskId()

### Description

Returns a unique ID for the current task.

### Prototype

```
U32 GUI_X_GetTaskId(void);
```

### Return value

ID of the current task as a 32-bit integer.

### Additional information

Used with a real-time operating system. It does not matter which value is returned, as long as it is unique for each task/ thread using the emWin API and as long as the value is always the same for each particular thread.

## 10.7.2 GUI\_X\_InitOS()

### Description

Creates the resource semaphore or mutex typically used by `GUI_X_Lock()` and `GUI_X_Unlock()`.

### Prototype

```
void GUI_X_InitOS(void);
```

## 10.7.3 GUI\_X\_Lock()

### Description

Locks the GUI.

### Prototype

```
void GUI_X_Lock(void);
```

### Additional information

This routine is called by the GUI before it accesses the display or before using a critical internal data structure. It blocks other threads from entering the same critical section using a resource semaphore/mutex until `GUI_X_Unlock()` has been called. When using a real time operating system, you normally have to increment a counting resource semaphore.

## 10.7.4 GUI\_X\_SignalEvent()

### Description

Signals an event.

### Prototype

```
void GUI_X_SignalEvent(void);
```

### Additional information

This function is optional, it is used only via the macro `GUI_X_SIGNAL_EVENT` or the function `GUI_SetSignalEventFunc()`.

## 10.7.5 GUI\_X\_Unlock()

### Description

Unlocks the GUI.

### Prototype

```
void GUI_X_Unlock(void);
```

### Additional information

This routine is called by the GUI after accessing the display or after using a critical internal data structure. When using a real time operating system, you normally have to decrement a counting resource semaphore.

## 10.7.6 GUI\_X\_WaitEvent()

### Description

Waits for an event.

### Prototype

```
void GUI_X_WaitEvent(void);
```

### Additional information

This function is optional, it is used only via the macro `GUI_X_WAIT_EVENT` or the function `GUI_SetWaitEventFunc()`.

## 10.7.7 GUI\_X\_WaitEventTimed()

### Description

Waits for an event for the given period.

### Prototype

```
void GUI_X_WaitEventTimed(int Period);
```

### Parameters

Parameter	Description
<code>Period</code>	<code>Period</code> in ms to be used.

### Additional information

This function is optional, it is used only via the macro `GUI_X_WAIT_EVENT_TIMED` or the function `GUI_SetWaitEventTimedFunc()`.



## 10.8 Examples

### Kernel interface routines for embOS

The following example shows an adaption for embOS (excerpt from file GUI\_X\_embOS.c located in the folder Sample\GUI\_X):

```
#include "RTOS.H"
static OS_TASK* _pGUITask;
static OS_RSEMA _RSema;
void GUI_X_InitOS(void) { OS_CreateRSEma(&_RSema); }
void GUI_X_Unlock(void) { OS_Unuse(&_RSema); }
void GUI_X_Lock(void) { OS_Use(&_RSema); }
U32 GUI_X_GetTaskId(void) { return (U32)OS_GetTaskID(); }
void GUI_X_WaitEvent(void) {
    _pGUITask = OS_GetpCurrentTask();
    OS_WaitEvent(1);
}
void GUI_X_SignalEvent(void) {
    if (_pGUITask) {
        OS_SignalEvent(1, _pGUITask);
    }
}
void GUI_X_WaitEventTimed(int Period) {
    static OS_TIMER Timer;
    static int Initialized;

    if (Period > 0) {
        if (Initialized != 0) {
            OS_DeleteTimer(&Timer);
        }
        Initialized = 1;
        OS_CreateTimer(&Timer, GUI_X_SignalEvent, Period);
        OS_StartTimer(&Timer);
        GUI_X_WaitEvent();
    }
}
```

### Kernel interface routines for uC/OS

The following example shows an adaption for uC/OS (excerpt from file GUI\_X\_uCOS.c located in the folder Sample\GUI\_X):

```
#include "INCLUDES.H"
static OS_EVENT * pDispSem;
static OS_EVENT * pGUITask;
U32 GUI_X_GetTaskId(void) { return ((U32)(OSTCBCur->OSTCBPrio)); }
void GUI_X_Unlock(void) { OSSemPost(pDispSem); }
void GUI_X_InitOS(void) {
    pDispSem = OSSemCreate(1);
    pGUITask = OSSemCreate(0);
}
void GUI_X_Lock(void) {
    INT8U err;
    OSSemPend(pDispSem, 0, &err);
}
```

### Kernel interface routines for Win32

The following is an excerpt from the Win32 simulation for emWin. When using the emWin simulation, there is no need to add these routines, as they are already in the library.

**Note**

Cleanup code has been omitted for clarity.

```
/*
 *
 *      emWin - Multitask interface for Win32
 *
 *
 *      The following section consisting of 4 routines is used to make
 *      emWin thread safe with WIN32
 */
static HANDLE hMutex;
void GUI_X_InitOS(void) {
    hMutex = CreateMutex(NULL, 0, "emWinSim - Mutex");
}
unsigned int GUI_X_GetTaskId(void) {
    return GetCurrentThreadId();
}
void GUI_X_Lock(void) {
    WaitForSingleObject(hMutex, INFINITE);
}
void GUI_X_Unlock(void) {
    ReleaseMutex(hMutex);
}
```

# Chapter 11

## File Access: GetData() functions

---

In this chapter, it is explained how emWin accesses external files through its GetData functions.

## 11.1 GetData functions

emWin's interface to a host file system is very simple: It is provided through GetData functions which read the binary file content into a buffer.

Throughout emWin, there are different types of GetData functions, all of which are listed below.

### Internal use of GetData functions

In general the GetData function is called one time at the beginning to retrieve overhead information and, after this, several times to retrieve the actual image data.

### Additional information

Raster-based image format functions (BMP, GIF, JPEG, DTA and PNG) require the GetData function to fetch at least one pixel line of data. It is recommended to make sure that the GetData function is able to fetch at least one pixel line of the biggest image used by the application.

### Different types of GetData functions

Every module or file type has its own type defined for a GetData function. Below listed is every different GetData type used in emWin. For more detailed information about each type, click it to go to the corresponding chapter.

The function prototype may be an alias to one of the global GetData function typedefs. If so, this is listed in the third column.

Module	Function prototype...	...resolves to
BMP files	GUI_BMP_GET_DATA_FUNC	GUI_GET_DATA_FUNC_I
JPEG files	GUI_JPEG_GET_DATA_FUNC	GUI_GET_DATA_FUNC_I
GIF files	GUI_GIF_GET_DATA_FUNC	GUI_GET_DATA_FUNC_I
PNG files	GUI_PNG_GET_DATA_FUNC	GUI_GET_DATA_FUNC_II
DTA files (streamed bitmaps)	GUI_DTA_GET_DATA_FUNC	GUI_GET_DATA_FUNC_II
SVG files	GUI_SVG_GET_DATA_FUNC	GUI_GET_DATA_FUNC_II
EMF files (emWin Movie Files)	GUI_MOVIE_GET_DATA_FUNC	GUI_GET_DATA_FUNC_II
XBF files	GUI_XBF_GET_DATA_FUNC	-
Language module (CSV and TXT files)	GUI_LANG_GET_DATA_FUNC	GUI_GET_DATA_FUNC_II
CHOOSEFILE dialog	CHOOSEFILE_GET_DATA_FUNC	-

## 11.2 File Access API

### Prototypes

Prototype	Description
<a href="#">GUI_GET_DATA_FUNC</a>	Abstract function type which may refer to either <a href="#">GUI_GET_DATA_FUNC_I</a> or <a href="#">GUI_GET_DATA_FUNC_II</a> .
<a href="#">GUI_GET_DATA_FUNC_I</a>	A callback which is used for loading external data into RAM.
<a href="#">GUI_GET_DATA_FUNC_II</a>	A callback which is used for loading external data into RAM.

## 11.2.1 GUI\_GET\_DATA\_FUNC

### Description

Abstract function type which may refer to either `GUI_GET_DATA_FUNC_I` or `GUI_GET_DATA_FUNC_II`.

It should only be used for function pointers which accept both above mentioned functions.

### Type definition

```
typedef int GUI_GET_DATA_FUNC(    void * p,  
                                const U8 * * ppData,  
                                unsigned NumBytes,  
                                U32 Off);
```

## 11.2.2 GUI\_GET\_DATA\_FUNC\_I

### Description

A callback which is used for loading external data into RAM.

This routine must manage its own buffer to read the external data into and pass the address to this buffer to `*ppData`.

### Type definition

```
typedef int GUI_GET_DATA_FUNC_I(
    void * p,
    const U8 * * ppData,
    unsigned NumBytes,
    U32 Off);
```

### Parameters

Parameter	Description
<code>p</code>	<b>in</b> Application defined void pointer, could be e.g. a file handle.
<code>ppData</code>	<b>in/out</b> This function must set <code>ppData</code> to point to the location where the requested data resides in.
<code>NumBytes</code>	Number of requested bytes.
<code>Off</code>	Defines the offset to use for reading the source data.

### Return value

The number of bytes which were actually read. If the number of read bytes does not match, the drawing function will return immediately.

### Example

The following is an example implementation for this function using the Win32 API.

```
int APP_GetData(void * p, const U8 ** ppData, unsigned NumBytes, U32 Off) {
    static char _acBuffer[0x200];
    HANDLE * phFile;
    DWORD NumBytesRead;
    phFile = (HANDLE *)p;
    //
    // Check buffer size
    //
    if (NumBytes > sizeof(acBuffer)) {
        NumBytes = sizeof(acBuffer);
    }
    //
    // Set file pointer to the required position
    //
    SetFilePointer(*phFile, Off, 0, FILE_BEGIN);
    //
    // Read data into buffer
    //
    ReadFile(*phFile, acBuffer, NumBytes, &NumBytesRead, NULL);
    //
    // Set data pointer to the beginning of the buffer
    //
    *ppData = acBuffer;
    //
    // Return number of available bytes
    //
    return NumBytesRead;
}
```

## 11.2.3 GUI\_GET\_DATA\_FUNC\_II

### Description

A callback which is used for loading external data into RAM.

This routine does not manage its own buffer. Instead, it receives a preallocated buffer to load the data into. The address to this buffer is `*ppData`.

### Type definition

```
typedef int GUI_GET_DATA_FUNC_II(
    void * p,
    const U8 ** ppData,
    unsigned NumBytes,
    U32 Off);
```

### Parameters

Parameter	Description
<code>p</code>	<b>in</b> Application defined void pointer, could be e.g. a file handle.
<code>ppData</code>	<b>in</b> Points to the location of the buffer address that needs to be filled with data read by this function.
<code>NumBytes</code>	Number of requested bytes.
<code>Off</code>	Defines the offset to use for reading the source data.

### Return value

The number of bytes which were actually read. If the number of read bytes does not match, the drawing function will return immediately.

### Example

The following is an example implementation for this function using the Win32 API.

```
int APP_GetData(void * p, const U8 ** ppData, unsigned NumBytes, U32 Off) {
    HANDLE * phFile;
    DWORD   NumBytesRead;
    U8      * pData;
    pData = (U8 *)*ppData;
    phFile = (HANDLE *)p;
    //
    // Set file pointer to the required position
    //
    SetFilePointer(*phFile, Off, 0, FILE_BEGIN);
    //
    // Read data into buffer
    //
    ReadFile(*phFile, pData, NumBytes, &NumBytesRead, NULL);
    //
    // Return number of available bytes
    //
    return NumBytesRead;
}
```



# Chapter 12

## MultiLayer / MultiDisplay support

---

Multiple displays and multiple layers can be utilized via emWin MultiLayer support. If the hardware supports multiple layers, MultiLayer support can be used. If the hardware does not include such a function, multiple layers can be implemented using the emWin SoftLayer feature.

MultiLayer and MultiDisplay support work the same way. Each layer / display can be accessed with its own color settings, its own size and its own display driver. Initialization of more than one layer is quite simple: The maximum number of available layers `GUI_NUM_LAYERS` should be defined in `GUIConf.h` and each layer needs a display driver device which should be created during the initialization in the configuration routine `LCD_X_Config()`. There is no limitation regarding the maximum number of available layers.

All SoftLayers use an internal driver which works with 32bpp. The SoftLayer composite is converted to the color setting of the display. SoftLayers and MultiLayer support can not be used in combination. Therefore SoftLayers have to be configured slightly different from MultiLayers.

## 12.1 Introduction

This chapter deals with multiple hardware layers (MultiLayer), multiple software layers (SoftLayer) and multiple displays (MultiDisplay). Since a lot of information is valid for each of those features, the following sections will just refer to it as layers unless there are functional differences.

Windows and drawing operations can be placed and performed on any layer. emWinView can output every single layer and the composite view in a separate window.

### 12.1.1 Selecting a layer for drawing operations

When drawing directly, per default layer 0 is used. Other layers can be selected by using the function `GUI_SelectLayer()`.

#### Example

The following example shows how to select a layer for drawing operations:

```
void MainTask(void) {
    GUI_Init();
    //
    // Draw something on default layer 0
    //
    GUI_SetBkColor(GUI_GREEN);
    GUI_Clear();
    GUI_DispStringHCenterAt("Layer 0", 100, 46);
    //
    // Draw something on layer 1
    //
    GUI_SelectLayer(1);
    GUI_SetBkColor(GUI_RED);
    GUI_Clear();
    GUI_SetColor(GUI_BLUE);
    GUI_FillRect(20, 20, 179, 79);
    GUI_SetColor(GUI_WHITE);
    GUI_SetTextMode(GUI_TM_TRANS);
    GUI_DispStringHCenterAt("Layer 1", 100, 46);
    while(1) {
        GUI_Delay(100);
    }
}
```

#### Screenshot of the above example

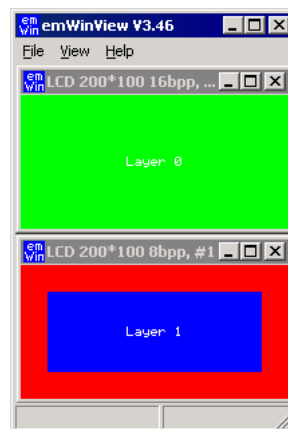

### 12.1.2 Selecting a layer for a window

The Window Manager automatically keeps track of which window is located in which layer. This is done in a fairly easy way: If the Window Manager is used, every layer has a top

level (desktop) window. Any other window in this layer is visible only if it is a descendant of the according desktop window. Windows are connected to a certain layer depending on if they are a descendant of the layer's desktop window.

### Example

The following example shows how to create 3 windows on 2 different desktop windows:

```
//
// Create 1 child window on desktop 0
//
hWin0 = WM_CreateWindowAsChild( 10, 20, 80, 70,
    WM_GetDesktopWindowEx(0), WM_CF_SHOW, _cbWin0, 0);
//
// Create 2 child windows on desktop 1
//
hWin1 = WM_CreateWindowAsChild( 10, 20, 80, 70,
    WM_GetDesktopWindowEx(1), WM_CF_SHOW, _cbWin1, 0);
hWin2 = WM_CreateWindowAsChild(110, 20, 80, 70,
    WM_GetDesktopWindowEx(1), WM_CF_SHOW, _cbWin2, 0);
```

The following table shows the screenshot and the window hierarchy of the above example:

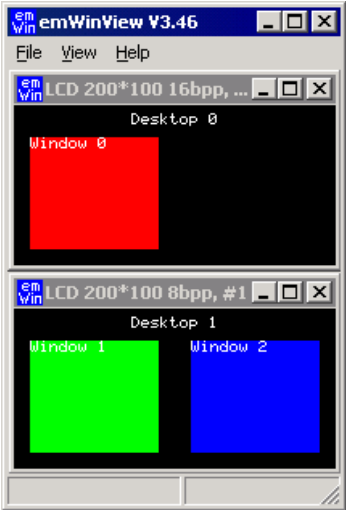
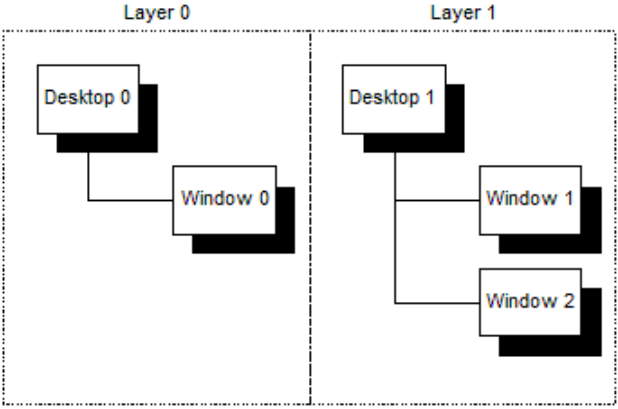
Screenshot	Window hierarchy
	

#### 12.1.2.1 Moving a window from one layer to another

This can sometime be very desirable and can easily be accomplished: If a window is detached from its parent (The desktop window of one layer or any descendant of this desktop window) and attached to a window which lies in another layer, this window actually moves from one layer to another layer.

### Example

The following example shows how to attach a window to a new parent window:

```
//
// Create 1 child window on desktop 0
//
hWin0 = WM_CreateWindowAsChild( 10, 20, 80, 70,
    WM_GetDesktopWindowEx(0), WM_CF_SHOW, _cbWin0, 0);
//
// Create 2 child windows on desktop 1
//
hWin1 = WM_CreateWindowAsChild( 10, 20, 80, 70,
    WM_GetDesktopWindowEx(1), WM_CF_SHOW, _cbWin1, 0);
hWin2 = WM_CreateWindowAsChild(110, 20, 80, 70,
```

```

WM_GetDesktopWindowEx(1), WM_CF_SHOW, _cbWin2, 0);
GUI_Delay(1000);
//
// Detach window 2 from desktop 1 and attach it to desktop 0
//
WM_AttachWindow(hWin2, WM_GetDesktopWindowEx(0));
    
```

The following table shows the screenshot and the window hierarchy of the above example before attaching the window to the new parent:

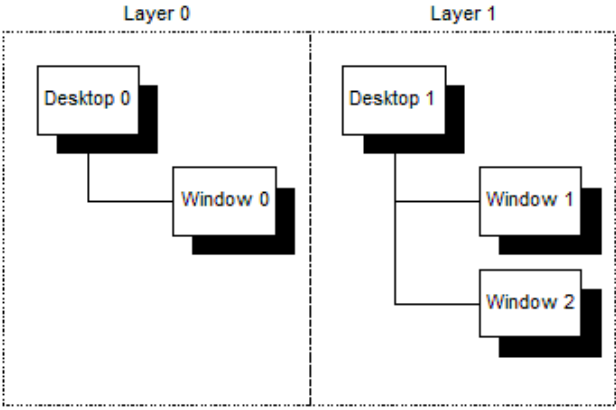
Screenshot	Window hierarchy
	

The next table shows the screenshot and the window hierarchy of the above example after attaching the window to the new parent:

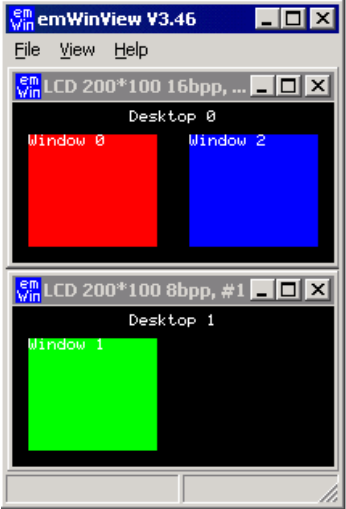
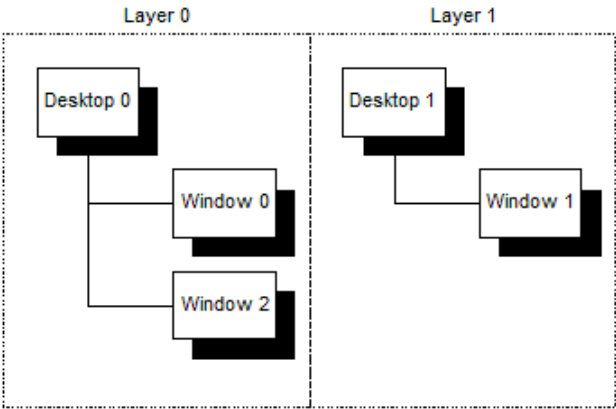
Screenshot	Window hierarchy
	

## 12.2 Using MultiLayer support

emWin does not distinguish between multiple layers or multiple displays. When using multiple layers normally the size and the driver for each layer is the same. The viewer shows each layer in a separate window. The composite window of the viewer shows all layers; layers with higher index are on top of layers with lower index and can have transparent pixels:

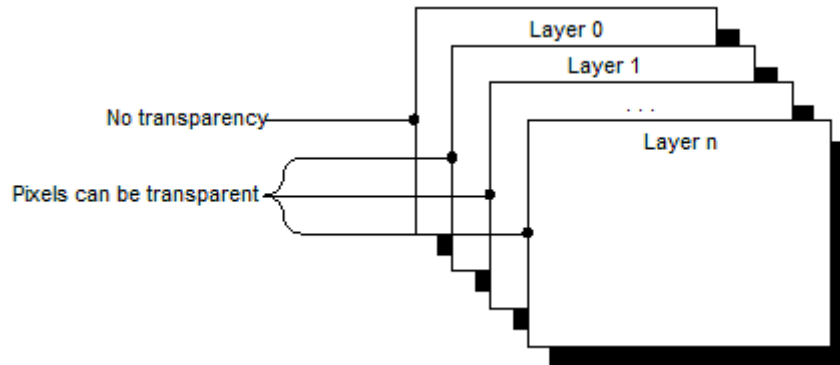

### 12.2.1 Transparency

Transparency means that at the position of pixels with color index 0 in a layer  $> 0$ , the color of the background layer is visible. Since for all but layer 0 Index 0 means transparency, Index 0 can not be used to display colors. This also means that the color conversion should never yield 0 as best match for a color, since this would result in a transparent pixel. This means that only some fixed palette modes or a custom palette mode should be used and that you need to be careful when defining your own palette. You need to make sure that the color conversion (24 bit RGB  $\rightarrow$  Index) never yields 0 as result.

#### Fixed palette modes

The only available fixed palette modes including transparency (not Alpha Blending) are GUICC\_M1555I and GUICC\_8666\_1. Details about fixed palette modes can be found in the chapter *Colors* on page 604.

#### Custom palette mode

If a custom palette should be used in a layer  $> 0$ , the first color should not be used from the color conversion routines. The following shows an example definition for a custom palette with 15 gray scales:

```
static const LCD_COLOR _aColors_16[] = {
    GUI_TRANSPARENT, 0x000000, 0x222222, 0x333333,
    0x444444, 0x555555, 0x666666, 0x777777,
    0x888888, 0x999999, 0xAAAAAA, 0BBBBBB,
    0xCCCCCC, 0xDDDDDD, 0xEEEEEE, 0xFFFFF
};
static const LCD_PHYSPALETTE _aPalette_16 = {
    16, _aColors_16
};
void LCD_X_Config(void) {
    //
    // Set display driver and color conversion for 1st layer
    //
    .
    .
    .
    //
    // Set user palette data (only required if no fixed palette is used)
    //
    LCD_SetLUTEx(1, _aPalette_16);
}
```

The description of the function `LCD_SetLUTEx()` can be found under *Custom palette mode* on page 629.

### Example

The following example shows how to use transparency. It draws 3 color bars in layer 0. Layer 1 is filled with white and 3 transparent items are drawn.

```
GUI_SelectLayer(0);
GUI_SetColor(GUI_RED);
GUI_FillRect(0, 0, 199, 33);
GUI_SetColor(GUI_GREEN);
GUI_FillRect(0, 34, 199, 66);
GUI_SetColor(GUI_BLUE);
GUI_FillRect(0, 67, 199, 99);
GUI_SelectLayer(1);
GUI_SetBkColor(GUI_WHITE);
GUI_Clear();
GUI_SetColor(GUI_BLACK);
GUI_DispStringHCenterAt("Layer 1", 100, 4);
GUI_SetColor(GUI_TRANSPARENT);
GUI_FillCircle(100, 50, 35);
GUI_FillRect(10, 10, 40, 90);
GUI_FillRect(160, 10, 190, 90);
```

### Screenshots of above example

The table below shows the contents of the separate layers and the composite view, as the result appears on the display:

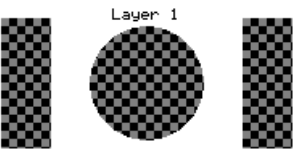
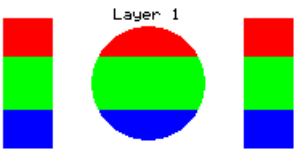
Layer 0	Layer 1	Display
		

## 12.2.2 Alpha blending

Alpha blending is a method of combining two colors for transparency effects. Assumed 2 colors  $C_0$  and  $C_1$  should be combined with alpha blending  $A$  (a value between 0 and 1 where 0 means invisible and 1 means 100% visible) the resulting color  $C_r$  can be calculated as follows:

$$C_r = C_0 * (1 - A) + C_1 * A$$

Logical colors are handled internally as 32 bit values. The lower 24 bits are used for the color information and the alpha blending is managed in the upper 8 bits. An alpha value of  $0x00$  means opaque and  $0xFF$  means completely transparent (invisible).

### Different methods

There are 3 different methods of managing the alpha information:

- **Layer alpha blending:** On systems with layer alpha blending the alpha value is fixed to the layer and can be set with the function `LCD_SetAlphaEx()`.
- **Lookup table (LUT) alpha blending:** This kind of alpha blending uses the LUT for managing the alpha information.
- **Pixel alpha blending:** Each pixel of the layer which has to be combined with the background consists of alpha blending information.

## Fixed palette modes

For LUT alpha blending the fixed palette modes 822216 and 84444 can be used. Pixel alpha blending is supported only in 32 bpp mode using the fixed palette mode 8888. For details about the fixed palette modes, refer to the chapter *Colors* on page 604.



## Example

The following example shows how to use pixel alpha blending. It draws a circle in layer 0 and a yellow triangle build of horizontal lines with a vertical gradient of alpha values:

```
GUI_SetColor(GUI_BLUE);
GUI_FillCircle(100, 50, 49);
GUI_SelectLayer(1);
GUI_SetBkColor(GUI_TRANSPARENT);
GUI_Clear();
for (i = 0; i < 100; i++) {
    U32 Alpha;
    Alpha = (i * 255 / 100) << 24;
    GUI_SetColor(GUI_YELLOW | Alpha);
    GUI_DrawHLine(i, 100 - i, 100 + i);
}
```

## Screenshots of above example

The table below shows the contents of the separate layers and the composite view, as the result appears on the display:

Layer 0	Layer 1	Display
		

## 12.2.3 Hardware cursors

The term “Hardware cursor” means the use of cursor images in a separate layer with a transparent background. If a hardware supports multiple layers and the ability of layer positioning emWin can be configured to use a separate layer for managing the cursor. The main advantages of this kind of cursor support are a better performance because only a few registers need to be changed on a movement and the ability of custom drawings in the cursor layer. For details about usage, refer to *GUI\_AssignCursorLayer* on page 3239.

## 12.2.4 MultiLayer example

For information about a multi-layer example, see the chapter *Simulation* on page 192. Further, the `Sample` folder contains the following example which shows how to use multiple layer support:

- `MULTILAYER_AlphaChromaMove.c`

## Screenshot of above example

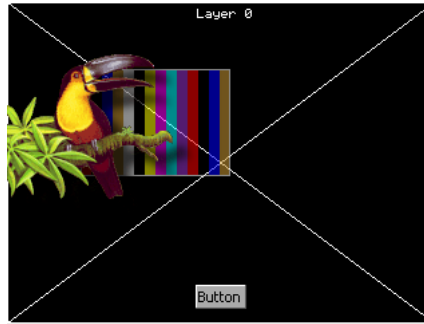

## 12.2.5 Configuring MultiLayer support

### LCD Configuration of the above MultiLayer example

```

void LCD_X_Config(void) {
    //
    // Set display driver and color conversion for first layer ...
    //
    GUI_DEVICE_CreateAndLink(GUIDRV_LIN_16, // Display driver
                             GUICC_655,    // Color conversion
                             0, 0);

    //
    // ... and configure it
    //
    LCD_SetSizeEx (0, 400, 234);           // Physical display size in pixels
    LCD_SetVRAMAddrEx(0, (void *)0xc00000); // Video RAM start address
    //
    // Set display driver and color conversion for second layer ...
    //
    GUI_DEVICE_CreateAndLink(GUIDRV_LIN_8, // Display driver
                             GUICC_86661, // Color conversion
                             0, 1);

    //
    // ... and configure it
    //
    LCD_SetSizeEx(1, 400, 234);           // Physical display size in pixels
    LCD_SetVRAMAddrEx(1, (void *)0xc00000); // Video RAM start address
}

```



## 12.3 Using MultiDisplay support

Each display can be accessed with its own driver and with its own settings.

### 12.3.1 Enabling MultiDisplay support

To enable the MultiDisplay support you have to define the maximum number of layers in `GUIConf.h`:

```
#define GUI_NUM_LAYERS 2 /* Enables support for 2 displays/layers */
```

Further you have to create and configure a display driver device for each layer.

### 12.3.2 Run-time screen rotation

In some cases it may be necessary to change the display orientation at run-time. The MultiDisplay support allows to do this. In this case the file `LCDConf.c` should contain a display configuration for each required display orientation. Switching the display orientation then works as follows:

- Select the configuration with the required display orientation with `GUI_SelectLayer()`.
- If the rotation requires a reinitialization of the display controller the right driver function for reinitializing should be called. This is `LCD_L0_Init()` for layer 0 and `LCD_L0_x_Init()` for higher layers, where "x" means the zero based index of the configuration.

### 12.3.3 MultiDisplay example

The example below shows a screenshot of the simulation with 2 displays. The first display is a 8bpp color display with a size of 320 \* 240 pixels. The driver is `GUIDRV_Lin_8`. The second display is a 1bpp black and white display with a size of 240 \* 128 pixels. The driver is `GUIDRV_SLin_1.c`:

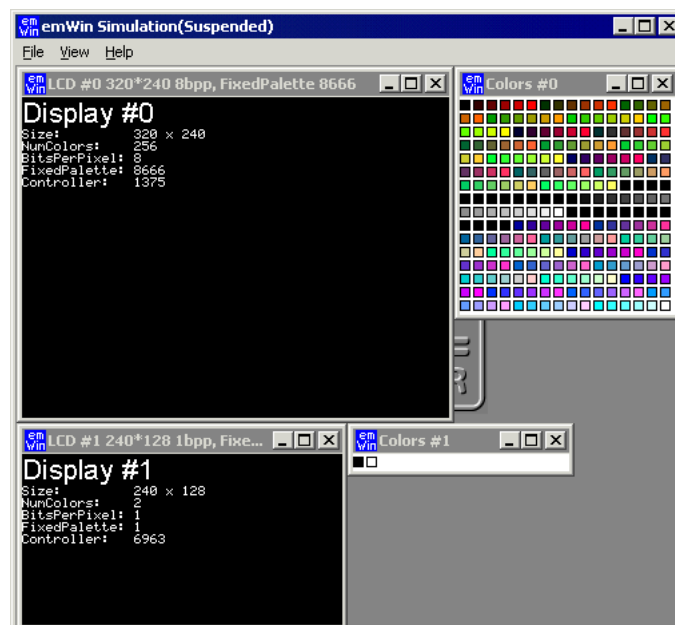

## 12.3.4 Configuring MultiDisplay support

### Configuration of the above example

```
void LCD_X_Config(void) {
    //
    // Set display driver and color conversion for first layer ...
    //
    GUI_DEVICE_CreateAndLink(GUIDRV_LIN_8, // Display driver
                             GUICC_8666, // Color conversion
                             0, 0);

    //
    // ... and configure it
    //
    LCD_SetSizeEx(0, 320, 240); // Physical display size in pixels
    LCD_SetVRAMAddrEx(0, (void *)0xc00000); // Video RAM start address
    //
    // Set display driver and color conversion for second layer ...
    //
    GUI_DEVICE_CreateAndLink(GUIDRV_SLIN_1, // Display driver
                             GUICC_1, // Color conversion
                             0, 1);

    //
    // ... and configure it
    //
    LCD_SetSizeEx(1, 240, 128); // Physical display size in pixels
}
```

## 12.4 Using SoftLayers

In case multiple hardware layers are not supported, emWin offers the possibility to make use of software layers. The advantage of softlayers is they can be used on any target hardware meeting the memory requirements. The disadvantage is additional CPU load to render the layers. Rendering is done automatically by executing the GUI. Alternatively the function `GUI_SOFTLAYER_Refresh()` can be called to immediately refresh the layers.

emWin SoftLayers are highly optimized. Layers are refreshed only if there is at least one dirty area. Drawing operations are tracked automatically to create/extend according dirty areas. A refresh is processed by dividing dirty areas in sub-rectangles which affect the same layers for faster color calculation. This way processing all layers unnecessarily for all pixels is avoided.

If there are dirty areas, pixel data is processed from the bottom to the top starting with the top opaque layer. Layers below the top opaque layer would not have any impact on the result.

### Mixing example (opaque and non-overlapping layers)

Assuming there is a configuration including 4 SoftLayers. Drawing operations have been done, so a dirty area exists. Layer 1 is opaque, layer 2 does not overlap the dirty area and layer 3 contains semi-transparent pixels. In this case the SoftLayer logic would ignore layer 0 and layer 2, so the only thing to do would be mixing the colors from layer 1 and 3.

### Mixing example (composite color and several semi-transparent layers)

Assuming there is a configuration including 4 SoftLayers in which the layers contain either transparency, semi-transparency or are not affected by the dirty area at all, the composite color is used as "opaque layer". In this case the composite color is mixed with the content of layer 0. The result would be mixed with the content of layer 1. In turn the result would be mixed with the content of layer 2. And so on...

## 12.4.1 Using SoftLayers within a simulation environment

In a simulation environment SoftLayers have to be set up differently from HardLayers. Below information should be a help for configuring the simulation properly for the use of SoftLayers. The according function descriptions can be found in the chapter *Simulation* on page 192.

### Composite color

SoftLayers consist of their own composite color which can be set using the function `GUI_SOFTLAYER_Enable()` or `GUI_SOFTLAYER_SetCompositeColor()`. The function `GUI_SIM_SetCompositeColor()` does not have an effect with SoftLayers.

### Composite size

The function `SIM_GUI_SetCompositeSize()` can be used for setting the size of the composite view. Calling this function is required for SoftLayer use.

### Transparency mode

In order to benefit from transparency effects, Layers can be configured for a certain transparency mode using the function `SIM_GUI_SetTransMode()`. Transparency can be implemented either via "zero transparency" or via "pixel alpha".

### SIMConf.c example

```
void SIM_X_Config() {
    SIM_GUI_SetCompositeSize(480, 272); // Set size of composite window
    SIM_GUI_SetTransMode(1, GUI_TRANSMODE_PIXELALPHA);
    SIM_GUI_SetTransMode(2, GUI_TRANSMODE_PIXELALPHA);
    SIM_GUI_SetTransMode(3, GUI_TRANSMODE_PIXELALPHA);
}
```

## 12.4.2 Memory requirements

emWin SoftLayers require storing additional information in RAM which can be subdivided in display related memory and layer related memory. The memory is taken from the memory pool which is assigned to emWin using `GUI_ALLOC_AssignMemory()` in function `GUI_X_Config()` (`GUIConf.c`).

### Required display related memory

Depending on the display size and color depth, SoftLayers require storing data for the following items:

- SoftLayer driver context.
- 32bpp buffer with the size of the display width.
- Frame buffer with the size and color depth of the display.

The required display related memory can be calculated using the following formula:

```
ReqMem = 68 Bytes + xSizeDisp * 4 + xSizeDisp * ySizeDisp * BytesPerPixelDisp
```

### Required layer related memory

Depending on the SoftLayer configuration, SoftLayers require additional memory to store one complete frame for each layer at a color depth of 32bpp.

The required display related memory can be calculated using the following formula:

```
ReqMem += xSize0 * ySize0 * 4 + xSize1 * ySize1 * 4 + ... (and so on)
```

### Explanation of terms

Term	Explanation
68 Bytes	Required for context information in the SoftLayer driver.
xSizeDisp	X-size of the display.
ySizeDisp	Y-size of the display.
BytesPerPixelDisp	Number of bytes per pixel used by the display.
xSize0	X-size of layer 0.
ySize0	Y-size of layer 0.

## 12.4.3 Configuring SoftLayers

SoftLayers need to be configured different from hardware layers. In order to set up the desired layers a data structure of type `GUI_SOFTLAYER_CONFIG` needs to be filled and passed to the function `GUI_SOFTLAYER_Enable()`. SoftLayers do not require each layer to have a separate driver device. There is an internal SoftLayer driver which is automatically used for all layers.

### LCDConf.c

```
void LCD_X_Config(void) {
    GUI_SOFTLAYER_CONFIG aConfig[] = {
        { 0, 0, 480, 272, 1 },
        { 0, 0, 120, 108, 1 },
        { 0, 0, 120, 74, 1 },
        { 30, 30, 420, 35, 1 },
    };
    //
    // Set display driver and color conversion for 1st layer
    //
    GUI_DEVICE_CreateAndLink(DISPLAY_DRIVER, COLOR_CONVERSION, 0, 0);
    //
    // Display driver configuration
}
```

```
//  
LCD_SetSizeEx    (0, XSIZE_PHYS,  YSIZE_PHYS);  
LCD_SetVSizeEx  (0, VXSIZE_PHYS,  VYSIZE_PHYS);  
LCD_SetVRAMAddrEx(0, (void *)VRAM_ADDR);  
//  
// SoftLayer activation after existing single layer configuration  
//  
GUI_SOFTLAYER_Enable(aConfig, GUI_COUNTOF(aConfig), GUI_DARKBLUE);  
}
```

## 12.5 MultiLayer API

The table below lists the available MultiLayer related routines in alphabetical order. Detailed descriptions follow:

### Functions

Routine	Description
General MultiLayer functions	
<code>GUI_AssignCursorLayer()</code>	The function assigns a layer to be used as cursor layer.
<code>GUI_GetLayerPosEx()</code>	Returns the X- and Y-position of the given layer.
<code>GUI_SelectLayer()</code>	Selects a layer for drawing operations.
<code>GUI_SetLayerAlphaEx()</code>	Sets the alpha blending of the given layer.
<code>GUI_SetLayerPosEx()</code>	Sets the X- and Y-position of the given layer.
<code>GUI_SetLayerSizeEx()</code>	Sets the X- and Y-size of the given layer.
<code>GUI_SetLayerVisEx()</code>	Sets the visibility of the given layer.
<code>LCD_GetNumLayers()</code>	Returns the number of layers configured in your configuration.
SoftLayer specific functions	
<code>GUI_SOFTLAYER_Enable()</code>	Enables and configures SoftLayers.
<code>GUI_SOFTLAYER_Refresh()</code>	Refreshes layers by re-rendering the dirty area.
<code>GUI_SOFTLAYER_SetCompositeColor()</code>	Sets the composite color.
<code>GUI_SOFTLAYER_MULTIBUF_Enable()</code>	Enables the automatic use of Multiple Buffering with SoftLayers.

### Data structures

Structure	Description
<code>GUI_SOFTLAYER_CONFIG</code>	Data structure used by <code>GUI_SOFTLAYER_Enable()</code> to configure a soft layer.

## 12.5.1 General MultiLayer functions

### 12.5.1.1 GUI\_AssignCursorLayer()

#### Description

The function assigns a layer to be used as cursor layer.

#### Prototype

```
void GUI_AssignCursorLayer(unsigned LayerIndex,  
                           unsigned CursorLayer);
```

#### Parameters

Parameter	Description
Index	Layer index.
CursorLayer	Layer to be used to manage the cursor.

#### Additional information

Using a hardware cursor means a layer is used as cursor layer. Contrary to the default cursor handling, where the cursor is drawn in the same video memory area as all other items, a hardware cursor is drawn in a separate layer. In this case emWin makes sure the background color of the hardware cursor layer is set to transparency and the selected cursor will be drawn into the layer. Whereas the default cursor management requires more or less calculation time to draw the cursor and to manage the background, moving a hardware cursor requires only the modification of a few registers. Note that using this function requires that the display driver supports layer positioning.

## 12.5.1.2 GUI\_GetLayerPosEx()

### Description

Returns the X- and Y-position of the given layer.

### Prototype

```
int GUI_GetLayerPosEx(unsigned LayerIndex,  
                     int * pxPos,  
                     int * pyPos);
```

### Parameters

Parameter	Description
<code>Index</code>	Layer index.
<code>pxPos</code>	Pointer to an integer to be used to return the X position of the given layer.
<code>pyPos</code>	Pointer to an integer to be used to return the Y position of the given layer.

### Additional information

To be able to use this function the hardware and the used display driver need to support layer positioning. If the driver does not support this feature the function returns immediately.



### 12.5.1.3 GUI\_SelectLayer()

#### Description

Selects a layer for drawing operations.

#### Prototype

```
unsigned GUI_SelectLayer(unsigned Index);
```

#### Parameters

Parameter	Description
<a href="#">Index</a>	Layer index.

#### Return value

[Index](#) of the previously selected layer.

### 12.5.1.4 GUI\_SetLayerAlphaEx()

#### Description

Sets the alpha blending of the given layer.

#### Prototype

```
int GUI_SetLayerAlphaEx(unsigned LayerIndex,  
                        int Alpha);
```

#### Parameters

Parameter	Description
<a href="#">Index</a>	Layer index.
<a href="#">Alpha</a>	<a href="#">Alpha</a> blending value of the given layer.

#### Return value

0        on success  
1        on error.

#### Additional information

To be able to use this function the hardware and the used display driver need to support layer alpha blending. If the driver does not support this feature the function returns immediately. The usable range of alpha values depends on the hardware. In many cases the range of alpha values is limited, for example 0 - 0x3f. emWin does not know something about limitations and passes the given value to the driver. It is the responsibility of the application to make sure that the given value is in a legal range.

### 12.5.1.5 GUI\_SetLayerPosEx()

#### Description

Sets the X- and Y-position of the given layer.

#### Prototype

```
int GUI_SetLayerPosEx(unsigned LayerIndex,  
                     int      xPos,  
                     int      yPos);
```

#### Parameters

Parameter	Description
<a href="#">Index</a>	Layer index.
<a href="#">xPos</a>	New X position of the given layer.
<a href="#">yPos</a>	New Y position of the given layer.

#### Additional information

To be able to use this function the hardware and the used display driver need to support layer positioning. If the driver does not support this feature the function returns immediately.

### 12.5.1.6 GUI\_SetLayerSizeEx()

#### Description

Sets the X- and Y-size of the given layer.

#### Prototype

```
int GUI_SetLayerSizeEx(unsigned LayerIndex,  
                      int      xSize,  
                      int      ySize);
```

#### Parameters

Parameter	Description
<a href="#">Index</a>	Layer index.
<a href="#">xSize</a>	New horizontal size in pixels of the given layer.
<a href="#">ySize</a>	New vertical size in pixels of the given layer.

#### Additional information

To be able to use this function the hardware and the used display driver need to support layer sizing. If the driver does not support this feature the function returns immediately.

### 12.5.1.7 GUI\_SetLayerVisEx()

#### Description

Sets the visibility of the given layer.

#### Prototype

```
int GUI_SetLayerVisEx(unsigned LayerIndex,  
                     int OnOff);
```

#### Parameters

Parameter	Description
<a href="#">Index</a>	Layer index.
<a href="#">OnOff</a>	1 if layer should be visible, 0 for invisible.

#### Additional information

To be able to use this function the hardware and the used display driver need to support this feature. If the driver does not support this feature the function returns immediately.

### 12.5.1.8 LCD\_GetNumLayers()

#### Description

Returns the number of layers configured in your configuration.

#### Prototype

```
int LCD_GetNumLayers(void);
```

#### Return value

Number of layers configured in your configuration.

## 12.5.2 SoftLayer specific functions

### 12.5.2.1 GUI\_SOFTLAYER\_Enable()

#### Description

Enables and configures SoftLayers.

#### Prototype

```
int GUI_SOFTLAYER_Enable(GUI_SOFTLAYER_CONFIG * pConfig,
                        int NumLayers,
                        GUI_COLOR CompositeColor);
```

#### Parameters

Parameter	Description
<code>pConfig</code>	Pointer to a GUI_SOFTLAYER_CONFIG data structure.
<code>NumLayers</code>	Number of layers to create using the config data.
<code>CompositeColor</code>	The composite color is used in case certain areas do not contain opaque colors.

#### Return value

0        on success  
1        on error.

#### Additional information

This function may be called only from within the function LCD\_X\_Config(). The function LCD\_X\_Config() is called automatically from GUI\_Init().

## 12.5.2.2 GUI\_SOFTLAYER\_Refresh()

### Description

Refreshes layers by rerendering the dirty area.

### Prototype

```
int GUI_SOFTLAYER_Refresh(void);
```

### Return value

- 0 if nothing was done
- 1 if something was done
- 2 on error.

### Additional information

This function is called from the function `GUI_Exec1()` if SoftLayers are enabled. After a refresh was performed, the dirty area gets cleared.



### 12.5.2.3 GUI\_SOFTLAYER\_SetCompositeColor()

#### Description

Sets the composite color.

#### Prototype

```
void GUI_SOFTLAYER_SetCompositeColor(U32 Color);
```

#### Parameters

Parameter	Description
Color	Color to be set as composite color.

#### Additional information

The function `SIM_GUI_SetCompositeColor()` does not have an effect with SoftLayers.

## 12.5.2.4 GUI\_SOFTLAYER\_MULTIBUF\_Enable()

### Description

Enables the automatic use of Multiple Buffering with SoftLayers.

### Prototype

```
int GUI_SOFTLAYER_MULTIBUF_Enable(int OnOff);
```

### Parameters

Parameter	Description
OnOff	0 to disable MultiBuffering support, 1 to enable MultiBuffering support.

### Return value

The function returns the previous setting.

- 0 if MultiBuffering has not been used
- 1 if MultiBuffering has already been used.

### Additional information

If Multiple Buffering is enabled, the function `GUI_SOFTLAYER_Refresh()` automatically calls the function `GUI_MULTIBUF_BeginEx()` and `GUI_MULTIBUF_EndEx()`.

## 12.5.3 Data structures

### 12.5.3.1 GUI\_SOFTLAYER\_CONFIG

#### Description

Data structure used by `GUI_SOFTLAYER_Enable()` to configurate a soft layer.

#### Type definition

```
typedef struct {  
    int  xPos;  
    int  yPos;  
    int  xSize;  
    int  ySize;  
    int  Visible;  
} GUI_SOFTLAYER_CONFIG;
```

#### Structure members

Member	Description
<code>xPos</code>	X-position.
<code>yPos</code>	Y-position.
<code>xSize</code>	X-size.
<code>ySize</code>	Y-size.
<code>Visible</code>	1 = visible, 0 = not visible.

# Chapter 13

## Display drivers

---

A display driver supports a particular family of display controllers and all displays which are connected to one or more of these controllers. The drivers can be configured by modifying their configuration files whereas the driver itself does not need to be modified. The configuration files contain all required information for the driver including how the hardware is accessed and how the controller(s) are connected to the display.

This chapter provides an overview of the display drivers available for emWin. It explains the following in terms of each driver:

- Which display controllers can be accessed, as well as supported color depths and types of interfaces.
- RAM requirements.
- Driver specific functions.
- How to access the hardware.
- Special configuration switches.
- Special requirements for particular display controllers.

## 13.1 Available display drivers

Since emWin V5 the driver interface has changed. Old display drivers, developed for emWin V4 or earlier, are not longer supported.

The display driver interface was changed in order to be able to configure drivers at run-time. This was required because emWin is often used as a precompiled library which should not have to be changed when using a different display.

### Note

Creating a precompiled library including the source files of a compile time configurable driver precludes configurability using the library.

To be able to support as many display controllers as possible in a short period, we migrated some of the older drivers to the new interface. Not all migrated display drivers are runtime configurable. The listings below show the sets of available runtime and compile time configurable display drivers.

### 13.1.1 Driver file naming convention

All files belonging to the same display driver begin with the name of the driver. So all files called `<DriverName>*.*` describe the whole driver.

#### Example

The following files describe the `GUIDRV_IST3088` display driver:

- `GUIDRV_IST3088.c`
- `GUIDRV_IST3088.h`
- `GUIDRV_IST3088_4.c`
- `GUIDRV_IST3088_Private.h`
- `GUIDRV_IST3088_X_4.c`

### 13.1.2 Run-time configurable drivers

The following table lists the currently available run-time configurable drivers developed for the current interface of emWin:

Driver	Purpose of driver	Supported bits/pixel
<code>GUIDRV_BitPlains</code>	This driver can be used for solutions without display controller. It manages separate 'bitplains' for each color bit. Initially it has been developed to support a solution for an R32C/111 which drives a TFT display without display controller. It can be used for each solution which requires the color bits in separate plains.	1 - 8
<code>GUIDRV_Dist</code>	This driver supports displays with multiple controllers.	Depends on the actual display drivers.
<code>GUIDRV_FlexColor</code>	This driver supports a large number of different display-controllers, but they have one thing in common regarding the FrameBuffer management. This commonality is the method of accessing the FrameBuffer. The access to the FrameBuffer is done in two steps for all these controllers. First, the rectangular area to be written or read is defined. Then the linear output of the data or the reading of the corresponding data takes place.	16, 18, 24
<code>GUIDRV_IST3088</code>	Support for some controllers of Integrated Solutions Technology Inc.	4
<code>GUIDRV_Lin</code>	This driver supports every display controller with linear addressable video memory with a direct (full bus) interface. This means that the video RAM is directly addressable by the address lines of the CPU.	1, 2, 4, 8, 16, 24, 32

Driver	Purpose of driver	Supported bits/pixel
	The driver contains no controller specific code. So it can also be used for solutions without display controller which require a driver which only manages the video RAM.	
GUIDRV_S1D13C00	Display driver for Epson S1D13C00, indirect interface only.	8
GUIDRV_S1D13L01	Display driver for Epson S1D13L01, indirect interface only.	8, 16
GUIDRV_S1D13L02	Display driver for Epson S1D13L02, indirect interface only.	16
GUIDRV_S1D13L04	Display driver for Epson S1D13L04, indirect interface only.	24, 32
GUIDRV_S1D13513	Display driver for Epson S1D13513, indirect interface only.	24, 32
GUIDRV_S1D13748	Display driver for Epson S1D13748, indirect interface only.	16
GUIDRV_S1D13781	Display driver for Epson S1D13781, indirect interface only.	8, 16
GUIDRV_S1D15G00	Display driver for Epson S1D15G00, indirect interface only.	12
GUIDRV_SH_MEM	Display driver for Sharp memory LCDs with 8- or 10 bit address interface.	1, 3
GUIDRV_SLin	This driver supports various display controllers with linear addressable FrameBuffer and indirect interface.	1, 2, 4
GUIDRV_SLinEPD	Driver for different ePaper display controller.	1
GUIDRV_SPage	This driver supports different display controllers with indirect interface and page-wise organized FrameBuffer. A page is a horizontally associated array of bytes, where one byte contains 2-8 vertically arranged pixels depending on the color depth.	1, 2, 4
GUIDRV_SSD1322	Display driver for Solomon OLED controller SSD1322.	4
GUIDRV_SSD1926	Display driver for Solomon SSD1926, indirect interface only.	8
GUIDRV_UC1698G	Display driver for UltraChip UC1698G.	1, 5

### 13.1.3 Compile-time configurable drivers

The following table lists the currently available drivers which has already been migrated to the current version of emWin:

Driver	Purpose of driver	Supported bits/pixel
GUIDRV_CompactColor_16	Predecessor of GUIDRV_FlexColor.	16
GUIDRV_Fujitsu_16	Display driver for Fujitsu MB87J2020 (Jasmine) Display driver for Fujitsu MB87J2120 (Lavender)	1, 2, 4, 8, 16
GUIDRV_Pagelbpp	Predecessor of GUIDRV_SPage.	1
GUIDRV_07X1	Display driver for some pane-wise organized display controllers with indirect interface.	2
GUIDRV_6331	Display driver for some Samsung display controllers with indirect interface.	16
GUIDRV_7528	Display driver for Sitronix ST7528	4
GUIDRV_7529	Display driver for Sitronix ST7529	1, 4, 5

#### Note

Some LCD-controllers may be supported twice, by a runtime and by a compile time configurable driver. In that case it is highly recommended to use/buy the runtime configurable driver, because those drivers are the successors of the compile time configurable drivers.

## 13.2 CPU / Display controller interface

Different display controllers can have different CPU interfaces. Basically there are two different interfaces:

- Direct interface
- Indirect interface

Whereas the direct interface accesses the video memory directly by the address bus of the CPU, the indirect interface requires a more complex communication with the display controller to get access to the video memory. This can be done by different kinds of connections:

- Parallel access
- 4 pin SPI interface
- 3 pin SPI interface
- I2C bus interface

The following explains these interfaces and how to configure them. Note that not all configuration macros are always required. For details about which macros are required, refer to *Detailed display driver descriptions* on page 3285.

### 13.2.1 Direct interface

Some display controllers (especially those for displays with higher resolution) require a full address bus, which means they are connected to at least 14 address bits. In a direct interface configuration, video memory is directly accessible by the CPU; the address bus is connected to the display controller.

The only knowledge required when configuring a direct interface is information about the address range (which will generate a CHIP-SELECT signal for the LCD controller) and whether 8-, 16- or 32-bit accesses should be used (bus-width to the display controller). In other words, you need to know the following:

- Base address for video memory access
- Base address for register access
- Distance between adjacent video memory locations (usually 1/2/4-byte)
- Distance between adjacent register locations (usually 1/2/4-byte)
- Type of access (8/16/32-bit) for video memory
- Type of access (8/16/32-bit) for registers

#### Typical block diagram

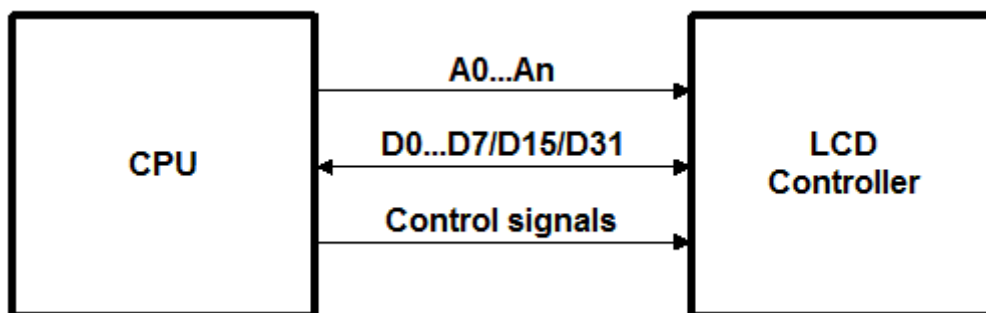

### 13.2.2 Indirect interface - Parallel bus

Most controllers for smaller displays use an indirect interface to connect to the CPU. With an indirect interface, only one address bit (usually A0) is connected to the LCD controller. Some of these controllers are very slow, so that the hardware designer may decide to connect it to input/output (I/O) pins instead of the address bus.

### Typical block diagram

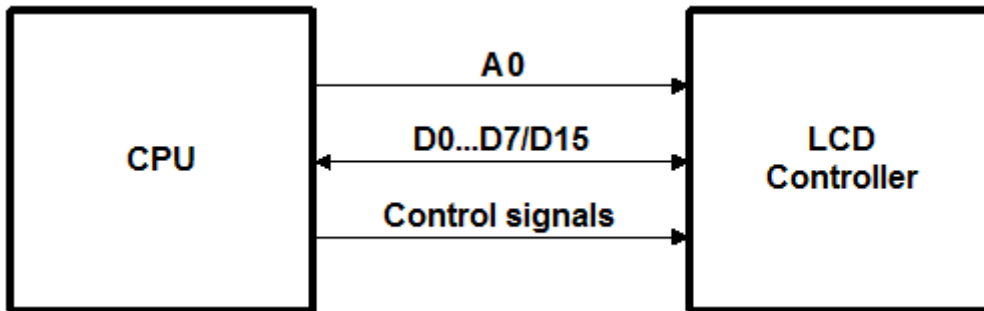

8 (16) data bits, one address bit and 2 or 3 control lines are used to connect the CPU and one LCD controller. Four macros inform the LCD driver how to access each controller used. If the LCD controller(s) is connected directly to the address bus of the CPU, configuration is simple and usually consists of no more than one line per macro. If the LCD controller(s) is connected to I/O pins, the bus interface must be simulated, which takes about 5-10 lines of program per macro (or a function call to a routine which simulates the bus interface). The signal **A0** is also called **C/D** (Command/Data), **D/I** (Data/Instruction) or **RS** (Register select), depending on the display controller.

#### 13.2.2.1 Example routines for connection to I/O pins

Examples can be found in the folder `Sample\LCD_X_Port`:

- `LCD_X_6800.c`, port routines for the 6800 parallel interface.
- `LCD_X_8080.c`, port routines for the 8080 parallel interface.

#### 13.2.3 Indirect interface - 4 pin SPI

Using a 4 pin SPI interface is very similar to a parallel interface. To connect a LCD display using 4 pin SPI interface the lines **A0**, **CLK**, **DATA**, and **CS** must be connected to the CPU.

##### Typical block diagram

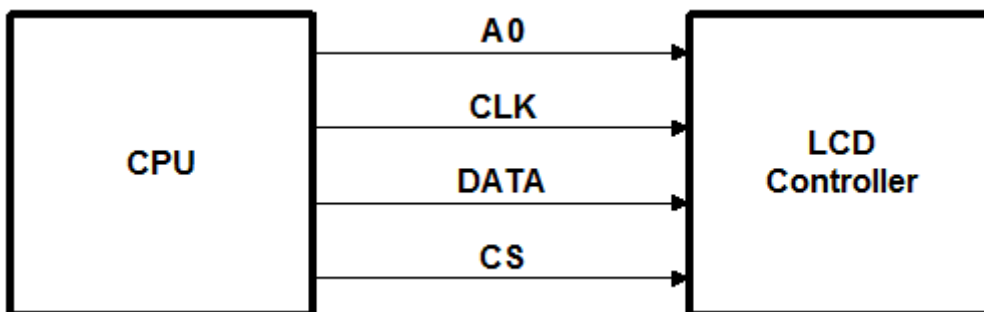

#### 13.2.3.1 Example routines for connection to I/O pins

An example can be found in the folder `Sample\LCD_X_Port`:

- `LCD_X_SERIAL.c`, port routines for a serial interface.

This sample uses port pins for the communication. This works very slow but can be used with each CPU. This should be optimized by the customer by using the hardware support of the CPU for this kind of communication.

#### 13.2.4 Indirect interface - 3 pin SPI

To connect a LCD display using 4 pin SPI interface the lines **CLK**, **DATA**, and **CS** must be connected to the CPU.



### Typical block diagram

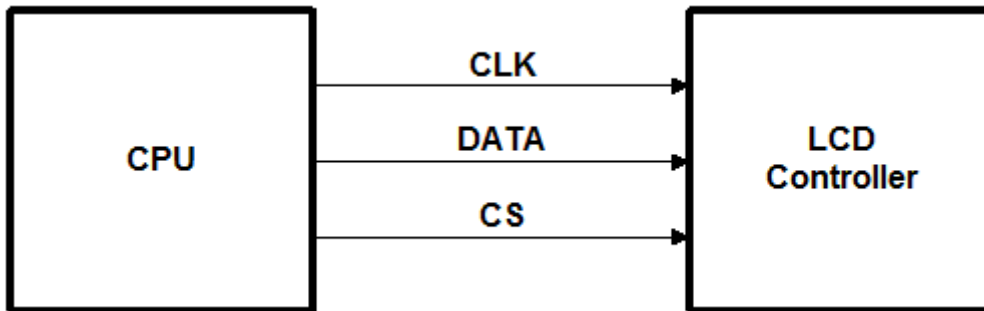

#### 13.2.4.1 Example routines for connection to I/O pins

This interface does not have a separate line for distinguish between data and commands to be transmitted to the display controller. There is no standardized method to manage this. Some controllers use an additional bit for distinguish between data and command, other controllers work different.

Examples can be found in the folder `Sample\LCD_X_Port`:

- `LCD_X_Serial_3Pin.c`, port routines for a 3 pin serial interface.
- `LCD_X_Serial_3Wire.c`, port routines for a 3 pin serial interface.

#### 13.2.5 Indirect interface - I2C bus

This kind of interface use only 2 lines and a standardized protocol for the communication with the display controller.

##### Typical block diagram

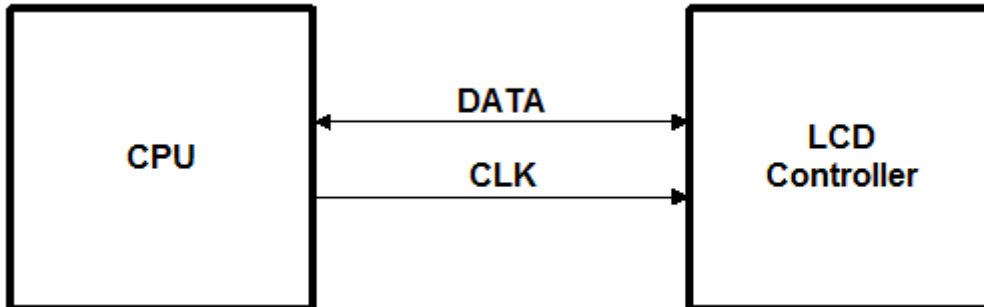

#### 13.2.5.1 Example routines for connection to I/O pins

An example can be found in the folder `Sample\LCD_X_Port`:

- `LCD_X_I2CBUS.c`, port routines for a I2C bus interface.

Similar to the serial communication examples this example uses port lines for the communication which works not very fast. If the CPU support this kind of communication these routines should be optimized by using the hardware functions.

## 13.3 Hardware interface configuration

The following explains how to configure the hardware communication between display driver and display controller.

### 13.3.1 Direct interface

Drivers which make use of a direct interface are usually configured by specifying the address of the video memory. In order to do so the function `LCD_SetVRAMAddrEx()` can be called. Details can be found in the section *Display driver API* on page 3426.

### 13.3.2 Indirect interface

There are 2 kinds of display drivers:

- Run-time configurable drivers
- Compile-time configurable drivers

Configuring these kinds of drivers works differently:

- Run-time configuration means the driver can be compiled without being configured. The configuration is done at run-time. This type of driver can still be configured at run-time when placed in a library.
- A compile-time configurable driver requires the configuration in a configuration header file, which is included at compile-time of the driver.

#### 13.3.2.1 Run-time configuration

Run-time configurable drivers do not need to be configured at compile time. So this drivers can be used in a precompiled library.

Each driver has its own function(s) for setting up the hardware interface. This is done by passing a pointer to a `GUI_PORT_API` structure containing function pointers to the hardware routines to be used:

##### 13.3.2.1.1 Elements of structure `GUI_PORT_API`

###### 8 bit interface

Element	Data type	Description
<code>pfWrite8_A0</code>	<code>void (*)(U8 Data)</code>	Pointer to a function which writes one byte to the controller with C/D line low.
<code>pfWrite8_A1</code>	<code>void (*)(U8 Data)</code>	Pointer to a function which writes one byte to the controller with C/D line high.
<code>pfWriteM8_A0</code>	<code>void (*)(U8 * pData, int NumItems)</code>	Pointer to a function which writes multiple bytes to the controller with C/D line low.
<code>pfWriteM8_A1</code>	<code>void (*)(U8 * pData, int NumItems)</code>	Pointer to a function which writes multiple bytes to the controller with C/D line high.
<code>pfRead8_A0</code>	<code>U8 (*)(void)</code>	Pointer to a function which reads one byte from the controller with C/D line low.
<code>pfRead8_A1</code>	<code>U8 (*)(void)</code>	Pointer to a function which reads one byte from the controller with C/D line high.

Element	Data type	Description
<a href="#">pfReadM8_A0</a>	<code>void (*)(U8 * pData, int NumItems)</code>	Pointer to a function which reads multiple bytes from the controller with C/D line low.
<a href="#">pfReadM8_A1</a>	<code>void (*)(U8 * pData, int NumItems)</code>	Pointer to a function which reads multiple bytes from the controller with C/D line high.

## 16 bit interface

Element	Data type	Description
<a href="#">pfWrite16_A0</a>	<code>void (*)(U16 Data)</code>	Pointer to a function which writes one 16 bit value to the controller with C/D line low.
<a href="#">pfWrite16_A1</a>	<code>void (*)(U16 Data)</code>	Pointer to a function which writes one 16 bit value to the controller with C/D line high.
<a href="#">pfWriteM16_A0</a>	<code>void (*)(U16 * pData, int NumItems)</code>	Pointer to a function which writes multiple 16 bit values to the controller with C/D line low.
<a href="#">pfWriteM16_A1</a>	<code>void (*)(U16 * pData, int NumItems)</code>	Pointer to a function which writes multiple 16 bit values to the controller with C/D line high.
<a href="#">pfRead16_A0</a>	<code>U16 (*)(void)</code>	Pointer to a function which reads one 16 bit value from the controller with C/D line low.
<a href="#">pfRead16_A1</a>	<code>U16 (*)(void)</code>	Pointer to a function which reads one 16 bit value from the controller with C/D line high.
<a href="#">pfReadM16_A0</a>	<code>void (*)(U16 * pData, int NumItems)</code>	Pointer to a function which reads multiple 16 bit values from the controller with C/D line low.
<a href="#">pfReadM16_A1</a>	<code>void (*)(U16 * pData, int NumItems)</code>	Pointer to a function which reads multiple 16 bit values from the controller with C/D line high.
<a href="#">pfReadM32_A1</a>	<code>void (*)(U32 * pData, int NumItems)</code>	Pointer to a function which reads multiple 32 bit values from the controller with C/D line high.

## 32 bit interface

Element	Data type	Description
<a href="#">pfWrite32_A0</a>	<code>void (*)(U32 Data)</code>	Pointer to a function which writes one 32 bit value to the controller with C/D line low.
<a href="#">pfWrite32_A1</a>	<code>void (*)(U32 Data)</code>	Pointer to a function which writes one 32 bit value to the controller with C/D line high.

Element	Data type	Description
<code>pfWriteM32_A0</code>	<code>void (*)(U32 * pData, int NumItems)</code>	Pointer to a function which writes multiple 32 bit values to the controller with C/D line low.
<code>pfWriteM32_A1</code>	<code>void (*)(U32 * pData, int NumItems)</code>	Pointer to a function which writes multiple 32 bit values to the controller with C/D line high.
<code>pfRead32_A0</code>	<code>U32 (*)(void)</code>	Pointer to a function which reads one 32 bit value from the controller with C/D line low.
<code>pfRead32_A1</code>	<code>U32 (*)(void)</code>	Pointer to a function which reads one 32 bit value from the controller with C/D line high.
<code>pfReadM32_A0</code>	<code>void (*)(U32 * pData, int NumItems)</code>	Pointer to a function which reads multiple 32 bit values from the controller with C/D line low.
<code>pfReadM32_A1</code>	<code>void (*)(U32 * pData, int NumItems)</code>	Pointer to a function which reads multiple 32 bit values from the controller with C/D line high.

## SPI interface

Element	Data type	Description
<code>pfSetCS</code>	<code>void (*)(U8 NotActive)</code>	Pointer to a function which is able to toggle the CS signal of the controller.

This structure contains function pointers for 8-, 16- and 32 bit access. Not all function pointers are used by each driver. The required functions are listed in the description of the according display driver.

## Example

The following shows a configuration example for the driver `GUIDRV_SLin`. It creates and configures the driver, initializes the required function pointers of the `GUI_PORT_API` structure and passes them to the driver:

```

GUI_DEVICE * pDevice;
CONFIG_SLIN Config = {0};
GUI_PORT_API PortAPI = {0};
//
// Set display driver and color conversion
//
pDevice = GUI_DEVICE_CreateAndLink(GUIDRV_SLIN_2, GUICC_2, 0, 0);
//
// Common display driver configuration
//
LCD_SetSizeEx (0, XSIZE, YSIZE);
LCD_SetVSizeEx(0, XSIZE, YSIZE);
//
// Driver specific configuration
//
Config.UseCache = 1;
GUIDRV_SLin_Config(pDevice, &Config);

```

```
//
// Select display controller
//
GUIDRV_SLin_SetS1D13700(pDevice);
//
// Setup hardware access routines
//
PortAPI.pfWrite16_A0 = _Write0;
PortAPI.pfWrite16_A1 = _Write1;
PortAPI.pfWriteM16_A0 = _WriteM0;
PortAPI.pfRead16_A1 = _Read1;
GUIDRV_SLin_SetBus8(pDevice, &PortAPI);
```

Details can be found in the descriptions of the run-time configurable drivers.

### 13.3.2.2 Compile-time configuration

A compile-time configurable driver requires its configuration in a header file. This configuration file is included when compiling the display driver. The compile-time configurable drivers use distinct macros for accessing the hardware. It depends on the interface details which macros are used. The following shows which macros are used by which kind of interface.

#### Macros used by an indirect interface

The following table shows the used hardware access macros:

Type	Macro	Description
F	LCD_READ_A0	Reads a byte from LCD controller with A0 - line low.
F	LCD_READ_A1	Reads a byte from LCD controller with A0 - line high.
F	LCD_WRITE_A0	Writes a byte to the display controller with A0 - line low.
F	LCD_WRITE_A1	Writes a byte to the display controller with A0 - line high.
F	LCD_WRITEM_A1	Writes several bytes to the LCD controller with A0 - line high.

#### Macros used by a 4 pin SPI interface

The following table shows the used hardware access macros:

Type	Macro	Description
F	LCD_WRITE_A0	Writes a byte to the display controller with A0 (C/D) - line low.
F	LCD_WRITE_A1	Writes a byte to the display controller with A0 (C/D) - line high.
F	LCD_WRITEM_A1	Writes several bytes to the LCD controller with A0 (C/D) - line high.

#### Macros used by a 3 pin SPI interface

The following table shows the used hardware access macros:

Type	Macro	Description
F	LCD_WRITE	Writes a byte to the display controller.
F	LCD_WRITEM	Writes several bytes to the LCD controller.

#### Macros used by a I2C bus interface

The following table shows the used hardware access macros:

Type	Macro	Description
F	LCD_READ_A0	Reads a status byte from LCD controller.
F	LCD_READ_A1	Reads a data byte from LCD controller.
F	LCD_WRITE_A0	Writes a instruction byte to the display controller.
F	LCD_WRITE_A1	Writes a data byte to the display controller.

Type	Macro	Description
F	LCD_WRITE_A1	Writes several data bytes to the LCD controller.

### 13.3.2.2.1 LCD\_READ\_A0

#### Description

Reads a byte from LCD controller with A0 (C/D) - line low.

#### Type

Function replacement

#### Prototype

```
#define LCD_READ_A0(Result)
```

Parameter	Description
<code>Result</code>	Result read. This is not a pointer, but a placeholder for the variable in which the value will be stored.

### 13.3.2.2.2 LCD\_READ\_A1

#### Description

Reads a byte from LCD controller with A0 (C/D) - line high.

#### Type

Function replacement

#### Prototype

```
#define LCD_READ_A1(Result)
```

Parameter	Description
<code>Result</code>	Result read. This is not a pointer, but a placeholder for the variable in which the value will be stored.

### 13.3.2.2.3 LCD\_WRITE\_A0

#### Description

Writes a byte to the display controller with A0 (C/D) - line low.

#### Type

Function replacement

#### Prototype

```
#define LCD_WRITE_A0(Byte)
```

Parameter	Description
<code>Byte</code>	Byte to write.

### 13.3.2.2.4 LCD\_WRITE\_A1

#### Description

Writes a byte to the display controller with A0 (C/D) - line low.

#### Type

Function replacement

#### Prototype

```
#define LCD_WRITE_A1(Byte)
```

Parameter	Description
Byte	Byte to write.

### 13.3.2.2.5 LCD\_WRITEM\_A1

#### Description

Writes several bytes to the LCD controller with A0 (C/D) - line high.

#### Type

Function replacement

#### Prototype

```
#define LCD_WRITEM_A1(paBytes, NumberOfBytes)
```

Parameter	Description
paBytes	Placeholder for the pointer to the first data byte.
NumberOfBytes	Number of data bytes to be written.

### 13.3.2.2.6 LCD\_WRITE

#### Description

Writes a byte to the LCD controller.

#### Type

Function replacement

#### Prototype

```
#define LCD_WRITE(Byte)
```

Parameter	Description
Byte	Byte to write.

### 13.3.2.2.7 LCD\_WRITEM

#### Description

Writes several bytes to the LCD controller.

#### Type

Function replacement

## Prototype

```
#define LCD_WRITEM(paBytes, NumberOfBytes)
```

Parameter	Description
<code>paBytes</code>	Placeholder for the pointer to the first data byte.
<code>NumberOfBytes</code>	Number of data bytes to be written.



## 13.4 Non-readable displays

### Framebuffer cache for non-readable displays

Some display controllers with an indirect interface do not support reading back display data. Especially displays which are connected via SPI interface often have this limitation.

In this case we recommend using a **framebuffer cache**. For details how to enable a display data cache, refer to the sub-chapter *Framebuffer cache* on page 140.

### Systems without enough RAM for a framebuffer cache

On systems with a very little RAM it is sometimes not possible to use a framebuffer cache. If a display is non-readable and a framebuffer cache can not be used, some features of emWin will not be supported. These features are the following:

- Cursors and Sprites
- XOR-operations, required for text cursors in EDIT and MULTIEDIT widgets
- Alpha blending
- Anti-aliasing
- Drawing SVGs

This is valid for all drivers where one data unit (8, 16 or 32 bit) represents one pixel. Display drivers, where one data unit represents more than one pixel, can not be used if no display data cache is available and the display is not readable. An example is the `GUIDRV_Page1bpp` driver where one byte represents 8 pixels.

## 13.5 Display orientation

If the original display orientation does not match the requirements, there are different ways to change the display orientation:

- Driver based configuration of the desired orientation
- Runtime rotation
- Using `GUI_SetOrientation()`

### 13.5.1 Driver based configuration of display orientation

If the display driver supports different orientations it is recommended to use the driver for setting up the right orientation. The way how to configure the display orientation then depends on the display driver to be used. Whereas the display orientation of the most common drivers is run-time configurable some drivers need to be configured at compile time.

#### 13.5.1.1 Run-time configuration







The display orientation of the most common driver is determined by creating the display driver device in `LCD_X_Config()` using the proper macro. The according macros are listed within the description of `GUIDRV_Lin` on page 3314.



#### 13.5.1.2 Compile-time configuration

The display orientation of some drivers with indirect interface like `GUIDRV_CompactColor_16` needs to be configured at compile time in the configuration file of the driver.

##### Display orientations

There are 8 possible display orientations; the display can be turned 0°, 90°, 180° or 270° and can also be viewed from top or from bottom. The default orientation is 0° and top view. These  $4 * 2 = 8$  different display orientations can also be expressed as a combination of 3 binary switches: X-mirroring, Y-mirroring and X/Y swapping. For this purpose, the binary configuration macros listed below can be used with each driver in any combination. If your display is not oriented well, take a look at the `config` switches in the table below to make it work properly. The orientation is handled as follows: Mirroring in X and Y first, then swapping (if selected).

Display	Orientation macros in driver configuration file	Display	Orientation macros in driver configuration file
	No orientation macro required		<code>#define LCD_MIRROR_Y 1</code>
	<code>#define LCD_MIRROR_X 1</code>		<code>#define LCD_MIRROR_X 1</code> <code>#define LCD_MIRROR_Y 1</code>
	<code>#define LCD_SWAP_XY 1</code>		<code>#define LCD_SWAP_XY 1</code> <code>#define LCD_MIRROR_Y 1</code>

Display	Orientation macros in driver configuration file	Display	Orientation macros in driver configuration file
	<pre>#define LCD_SWAP_XY 1 #define LCD_MIRROR_X 1</pre>		<pre>#define LCD_SWAP_XY 1 #define LCD_MIRROR_X 1 #define LCD_MIRROR_Y 1</pre>

Details on how to use multiple orientations simultaneously can be found in the section *Run-time screen rotation* on page 3233.

## 13.5.2 Runtime rotation

The runtime rotation functions make it possible to change the current driver at runtime. It allows to add up to 7 drivers to the primarily configured (default) driver of a layer. Basically usage is the following:

- Basic driver setup (default driver) in `LCD_X_Config()`.
- Add additional drivers to be used for different orientations.
- Optionally set a configuration callback routine.
- Use the API functions to change the driver.

When selecting a driver the current one will be deleted and unlinked and a new one is created and linked into the device chain of the layer. Immediately after creating a new driver the configuration callback function is called before the driver will be initialized. The color configuration to be used when creating and linking a driver is taken from the default driver.

The following set of functions may be used:

Routine	Description
<code>LCD_ROTATE_AddDriver()</code>	Adds a driver to be used for display rotation.
<code>LCD_ROTATE_AddDriverEx()</code>	Adds a driver to be used for display rotation of the given layer.
<code>LCD_ROTATE_DecSel()</code>	Decrements the current selection.
<code>LCD_ROTATE_DecSelEx()</code>	Decrements the current selection of the given layer.
<code>LCD_ROTATE_IncSel()</code>	Increments the current selection.
<code>LCD_ROTATE_IncSelEx()</code>	Increments the current selection of the given layer.
<code>LCD_ROTATE_SetCallback()</code>	Sets a function to be called immediately after a driver has been selected.
<code>LCD_ROTATE_SetSel()</code>	Selects the driver with the given index to be used.
<code>LCD_ROTATE_SetSelEx()</code>	Selects the driver with the given index to be used for the given layer.

### 13.5.2.1 LCD\_ROTATE\_AddDriver()

#### Description

Adds a driver to be used for display rotation. It is recommended that it is a variant of the default driver with different orientation.

#### Prototype

```
int LCD_ROTATE_AddDriver(const GUI_DEVICE_API * pDriver);
```

#### Parameters

Parameter	Description
<code>pDriver</code>	Pointer to a display driver API.

#### Return value

- 0 on success.
- 1 on error.

## 13.5.2.2 LCD\_ROTATE\_AddDriverEx()

### Description

Adds a driver to be used for display rotation of the given layer. It is recommended that it is a variant of the default driver with different orientation.

### Prototype

```
int LCD_ROTATE_AddDriverEx(const GUI_DEVICE_API * pDeviceAPI,  
                           int LayerIndex);
```

### Parameters

Parameter	Description
<code>pDriver</code>	Pointer to a display driver API.
<code>LayerIndex</code>	Layer index to be used.

### Return value

0        on success.  
1        on error.

### 13.5.2.3 LCD\_ROTATE\_DecSel()

#### Description

Decrements the current selection. If the current driver is the default driver it selects the driver last added.

#### Prototype

```
int LCD_ROTATE_DecSel(void);
```

#### Return value

0	on success.
1	on error.

### 13.5.2.4 LCD\_ROTATE\_DecSelEx()

#### Description

Decrements the current selection of the given layer. If the current driver is the default driver it selects the driver last added.

#### Prototype

```
int LCD_ROTATE_DecSelEx(int LayerIndex);
```

#### Parameters

Parameter	Description
<code>LayerIndex</code>	Layer index to be used.

#### Return value

0        on success.  
1        on error.

### 13.5.2.5 LCD\_ROTATE\_IncSel()

#### Description

Increments the current selection. If the current driver is the last driver it selects the default driver.

#### Prototype

```
int LCD_ROTATE_IncSel(void);
```

#### Return value

0	on success.
1	on error.



### 13.5.2.6 LCD\_ROTATE\_IncSelEx()

#### Description

Increments the current selection of the given layer. If the current driver is the last driver it selects the default driver.

#### Prototype

```
int LCD_ROTATE_IncSelEx(int LayerIndex);
```

#### Parameters

Parameter	Description
<code>LayerIndex</code>	Layer index to be used.

#### Return value

0        on success.  
1        on error.

### 13.5.2.7 LCD\_ROTATE\_SetCallback()

#### Description

Sets a function to be called immediately after a driver has been selected. It is called immediately after creation and before initializing.

#### Prototype

```
int LCD_ROTATE_SetCallback(void ( *pcbConfig)(GUI_DEVICE * , int , int ),  
                           int LayerIndex);
```

#### Parameters

Parameter	Description
<a href="#">pCbOnConfig</a>	Function to be called to configure driver.

#### Return value

0        on success.  
1        on error.

#### Additional information

Main purpose of that function is to set a routine which is called by emWin to configure all properties of the driver. It is called immediately after selecting a driver. At least the display size has to be configured. In general it has to configure all things which normally are set in `LCD_X_Config()`.

### 13.5.2.8 LCD\_ROTATE\_SetSel()

#### Description

Selects the driver with the given index to be used.

#### Prototype

```
int LCD_ROTATE_SetSel(int Index);
```

#### Parameters

Parameter	Description
<a href="#">Index</a>	Zero-based index of the driver to be used.

#### Return value

0        on success.  
1        on error.

### 13.5.2.9 LCD\_ROTATE\_SetSelEx()

#### Description

Selects the driver with the given index to be used for the given layer.

#### Prototype

```
int LCD_ROTATE_SetSelEx(int Index,  
                        int LayerIndex);
```

#### Parameters

Parameter	Description
<a href="#">Index</a>	Zero-based index of the driver to be used.
<a href="#">LayerIndex</a>	Layer to be used.

#### Return value

0        on success.  
1        on error.

### 13.5.3 Function based configuration of display orientation

Another possibility to set up the display orientation is to call `GUI_SetOrientation()`. Using these functions is recommended if the display driver can not be used.

Routine	Description
<code>GUI_SetOrientation()</code>	This function changes the display orientation by using a rotation device.
<code>GUI_SetOrientationEx()</code>	This function changes the orientation in the specified layer by using a rotation device.

### 13.5.3.1 GUI\_SetOrientation()

#### Description









This function changes the display orientation by using a rotation device.

#### Prototype

```
int GUI_SetOrientation(int Orientation);
```

#### Parameters

Parameter	Description
Orientation	See the table below for an overview of valid values.

Resulting display	Value to use for GUI_SetOrientation()	Resulting display	Value to use for GUI_SetOrientation()
	0		GUI_MIRROR_Y
	GUI_MIRROR_X		GUI_MIRROR_X   GUI_MIRROR_Y
	GUI_SWAP_XY		GUI_SWAP_XY   GUI_MIRROR_Y
	GUI_SWAP_XY   GUI_MIRROR_X		GUI_SWAP_XY   GUI_MIRROR_X   GUI_MIRROR_Y

#### Return value

- 0 on success.
- 1 on error.

#### Additional information

The rotation device covers the complete virtual screen within an internal screen buffer. Because of this the use of this function requires additional memory for this additional screen buffer. The number of required bytes can be calculated as follows:

$$\text{Virtual xSize} * \text{Virtual ySize} * \text{BytesPerPixel}$$

The number of bytes per pixel is for configurations from 1-8bpp 1, for systems with more than 8bpp up to 16bpp 2 and for systems with more than 16bpp 4. Each drawing operation first updates this buffer. After this the affected pixels are passed to the display driver device.

### 13.5.3.2 GUI\_SetOrientationEx()

#### Description

This function changes the orientation in the specified layer by using a rotation device.

#### Prototype

```
int GUI_SetOrientationEx(int Orientation,  
                        int LayerIndex);
```

#### Parameters

Parameter	Description
<a href="#">Orientation</a>	Refer to <i>GUI_SetOrientation</i> on page 3278 for an overview of valid values.
<a href="#">LayerIndex</a>	Index of the layer which <a href="#">Orientation</a> has to be (re-)configured.

#### Return value

0        on success.  
1        on error.

#### Additional information

See `GUI_SetOrientation()`.

## 13.5.4 Orientation flags

### Description

Flags used by several GUI functions to define the display orientation.

### Definition

```
#define GUI_MIRROR_X    (1 << 0)
#define GUI_MIRROR_Y    (1 << 1)
#define GUI_SWAP_XY     (1 << 2)
```

### Symbols

Definition	Description
<a href="#">GUI_MIRROR_X</a>	Mirroring the X-axis.
<a href="#">GUI_MIRROR_Y</a>	Mirroring the Y-axis.
<a href="#">GUI_SWAP_XY</a>	Swapping X- and Y-axis.



## 13.6 Display driver callback function

A display driver requires a callback function. It is called by the driver for several tasks. One task is putting the display driver into operation which is also explained in the chapter *Configuration* on page 109. It is also called for other tasks which require hardware related operations like switching the display on and off or setting a lookup table entry.

### Note

Refer to `LCD_X_DisplayDriver()` for a full API description of the function.

### 13.6.1 Commands passed to the callback function

The following explains the common commands passed to the callback function. For details about display driver specific commands, refer to *Detailed display driver descriptions* on page 3285. They are described under the topic 'Additional callback commands'.

#### 13.6.1.1 LCD\_X\_INITCONTROLLER

##### Description

As mentioned above the application should initialize the display controller and put it into operation if the callback routine receives this command. No parameters are passed on this command. Typically an initialization routine which initializes the registers of the display controller should be called in reaction of this command.

##### Parameters

None.

#### 13.6.1.2 LCD\_X\_ON

##### Description

This command switches the display on.

##### Parameters

None.

#### 13.6.1.3 LCD\_X\_OFF

##### Description

This command switches the display off.

##### Parameters

None.

#### 13.6.1.4 LCD\_X\_SETALPHA

##### Description

Sets the required layer alpha value. Should be used to set up the layer alpha register.

##### Parameters

`pData` points to a data structure of type `LCD_X_SETALPHA_INFO`.

### Elements of structure LCD\_X\_SETALPHA\_INFO

Data type	Element	Description
int	Alpha	Alpha value to be used. 255 for transparent and 0 for opaque.

### 13.6.1.5 LCD\_X\_SETLUTENTRY

#### Description

A lookup table entry should be set. The typical reaction should be writing an entry into the lookup table of the display controller.

#### Parameters

`pData` points to a data structure of type `LCD_X_SETLUTENTRY_INFO`.

### Elements of structure LCD\_X\_SETLUTENTRY\_INFO

Data type	Element	Description
LCD_COLOR	Color	RGB value of the color to be written to the LUT. Note that the format required by the hardware could be different to the RGB format.
U8	Pos	Zero based index of the LUT entry to be set.

### 13.6.1.6 LCD\_X\_SETORG

#### Description

The function is used in relation with virtual screens. It is called if the origin of the display should be set. A typical reaction can be modifying the frame buffer start address.

#### Parameters

`pData` points to a data structure of type `LCD_X_SETORG_INFO`.

### Elements of structure LCD\_X\_SETORG\_INFO

Data type	Element	Description
int	xPos	New X-position of the physical display position within the virtual screen.
int	yPos	New Y-position of the physical display position within the virtual screen.

### 13.6.1.7 LCD\_X\_SETPOS

#### Description

This function is used in relation with setting up the layer position. Please note that normally a layer could not exceed the physical range of a display. But it is possible to achieve the effect of a layer positioned outside of the display without modifying the content of the frame buffer. Such an effect could be used for example for moving a picture into the visible area of the display and/or for shifting it out of the display without any additional CPU load for repainting.

If for example a layer should look like starting with a negative X/Y-coordinate, for example (-10, -5) that values could not be used directly for setting up the registers of the layer position. The physical layer coordinate needs to be (0, 0) in that case. To achieve the effect of a negative position an offset needs to be added to the framebuffer start address. Further the visible length and height of the layer need to be adapted by subtracting the intersection

in X and Y. If the given coordinates (for example passed to `GUI_SetLayerPosEx()`) lead into a completely invisible layer `emWin` automatically sends a `LCD_X_SETVIS` command.

### Parameters

`pData` points to a data structure of type `LCD_X_SETPOS_INFO`.

### Elements of structure `LCD_X_SETPOS_INFO`

Data type	Element	Description
int	xPos	Physical X-position to be used to set up the layer position register.
int	yPos	Physical Y-position to be used to set up the layer position register.
int	xLen	Physical X-size of the layer.
int	yLen	Physical Y-size of the layer.
int	BytesPerPixel	Bytes used for one pixel.
U32	Off	Offset to be added to the framebuffer start address.

### Requirements

To be able to use that functionality the following must be possible:

- A stride register should exist which defines the number of bytes from one line of frame buffer data to the next line.
- It must be possible to set up the frame buffer start address to any pixel address.
- The size of the visual area of the layer must be configurable.

## 13.6.1.8 LCD\_X\_SETSIZE

### Description

Used to set up the size of a layer at runtime.

### Parameters

`pData` points to a data structure of type `LCD_X_SETSIZE_INFO`.

### Elements of structure `LCD_X_SETSIZE_INFO`

Data type	Element	Description
int	xSize	New X-size to be used for the given layer.
int	ySize	New Y-size to be used for the given layer.

### Additional information

After changing the size of a layer at runtime normally the content of the layer needs to be repainted. Please note that this is not done automatically.

## 13.6.1.9 LCD\_X\_SETVIS

### Description

Used to set up the visibility of a layer at runtime.

### Parameters

`pData` points to a data structure of type `LCD_X_SETVIS_INFO`.

### Elements of structure LCD\_X\_SETVIS\_INFO

Data type	Element	Description
int	OnOff	1 if layer should be visible, 0 for invisible.

### 13.6.1.10 LCD\_X\_SETVRAMADDR

#### Description

This command is passed by the driver to tell the callback routine the start address of the video RAM. The typical reaction should be writing the address to the frame buffer start address register.

#### Parameters

[pData](#) points to a data structure of type LCD\_X\_SETVRAMADDR\_INFO.

### Elements of structure LCD\_X\_SETVRAMADDR\_INFO

Data type	Element	Description
void *	pVRAM	Points to the start address of the video RAM. This address is typically written to the video RAM base address register of the display controller.

### 13.6.1.11 LCD\_X\_SHOWBUFFER

#### Description

This command is used in relation with multiple buffers. It tells the callback routine that the buffer with the given index should become visible.

#### Parameters

[pData](#) points to a data structure of type LCD\_X\_SHOWBUFFER\_INFO.

### Elements of structure LCD\_X\_SHOWBUFFER\_INFO

Data type	Element	Description
int	Index	Index of buffer which should become visible as soon as possible.

#### Additional information

Making the buffer visible could be done by setting the right framebuffer start address immediately or by doing that within an ISR which is called in the vertical non display period.

## 13.7 Detailed display driver descriptions

### 13.7.1 GUIDRV\_BitPlains

This driver has been developed for systems without display controller. It manages each color bit in a separate plain. This means if the color depth is for example 4 bits per pixel the driver manages 4 bit plains each containing one bit.

Initially the driver has been made to drive monochrome and color TFTs with an R323C/111 CPU via SPI interface. But the driver can be used also for similar applications.

The driver does only manage the content of the bit plains. It does not contain any display controller specific code.

#### 13.7.1.1 Supported hardware

##### Controllers

None.

##### Bits per pixel

The driver has been developed for a color depth of 1 to 8 bits per pixel.

##### Interface

It is required to write an application defined routine which uses the content of the bit plains to generate the color signals for the display. The driver comes with a sample for the R32C/111 CPU which refreshes the display via timer interrupt routine using the SPI interface.

#### 13.7.1.2 Driver selection

To use `GUIDRV_BitPlains` for the given display, the following command can be used e.g.:

```
pDevice = GUI_DEVICE_CreateAndLink(GUIDRV_BITPLAINS, GUICC_M111, 0, 0);
```

More information about using the proper palette mode can be found in the chapter *Colors* on page 604.

### 13.7.1.3 Display data RAM organization

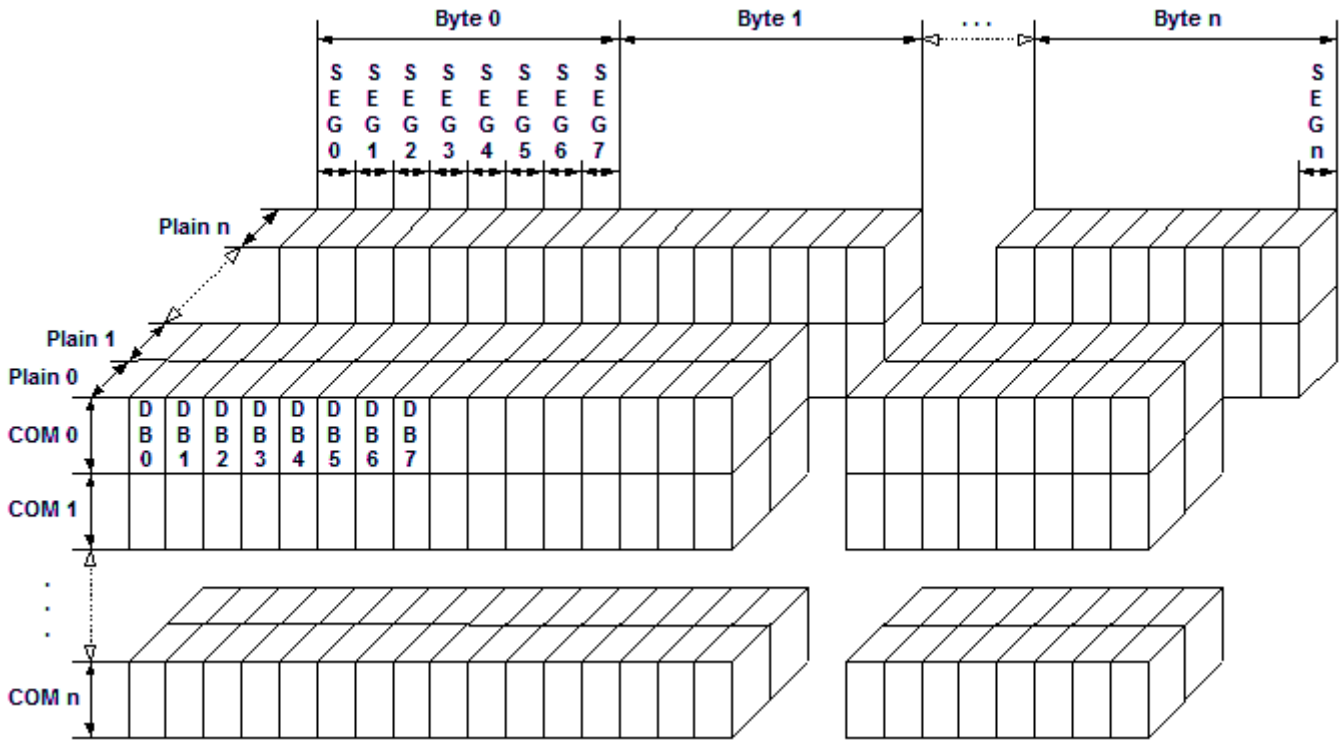

The picture above shows the relation between the display memory and the SEG and COM lines of the display. The display memory is divided into separate plains for each bit of the colors. This means that bit 0 of each pixel is stored in plain 0, the bit 1 in plain 1 and so on. The advantage of this method is that each color bit of the display data can be accessed very quickly.

### 13.7.1.4 RAM requirements

The required size of the display memory area can be calculated as follows:

$$\text{Size} = \text{BitsPerPixel} * (\text{LCD\_XSIZE} + 7) / 8 * \text{LCD\_YSIZE}$$

**Note**

The pointers to the bit plain areas need to be passed to the configuration routine of the driver. They are not allocated within the driver but from application side.

### 13.7.1.5 Hardware configuration

Normally, the hardware interface is an interrupt service routine (ISR) which updates the display. The driver comes with an example written in "C" code. This routine should serve as an example.

### 13.7.1.6 Additional run-time configuration

The table below shows the available run-time configuration routines of this driver:

Routine	Description
<code>GUIDRV_BitPlains_Config()</code>	This function passes a pointer to a <code>CONFIG_BITPLAINS</code> structure to the driver.
<code>LCD_SetVRAMAddrEx()</code>	Sets the address of the video RAM.

**Elements of structure CONFIG\_VRAM\_BITPLAINS**

Data type	Element	Description
U8 *	apVRAM	Array of pointers to the memory locations to be used by the driver for each bit plain. If the driver for example works in 2bpp mode only the first 2 pointers are used (One plain for each bit of the color information).

### 13.7.1.7 GUIDRV\_BitPlains\_Config()

#### Description

This function passes a pointer to a CONFIG\_BITPLAINS structure to the driver.

#### Prototype

```
void GUIDRV_BitPlains_Config(GUI_DEVICE      * pDevice,
                             CONFIG_BITPLAINS * pConfig);
```

#### Parameters

Parameter	Description
<code>pDevice</code>	Pointer to the driver device.
<code>pConfig</code>	Pointer to a CONFIG_BITPLAINS structure explained below.

#### Elements of structure CONFIG\_BITPLAINS

Data type	Element	Description
int	Mirror	Config switch to mirror the bits of the display data.

#### Configuration example

```
//
// Data arrays to be used by the display driver
//
static U8 _aPlain_0[BYTES_PER_LINE * YSIZE_PHYS];
static U8 _aPlain_1[BYTES_PER_LINE * YSIZE_PHYS];
static U8 _aPlain_2[BYTES_PER_LINE * YSIZE_PHYS];
//
// Structure to be passed to the driver
//
static struct {
    U8 * apVRAM[8];
} _VRAM_Desc = {
    _aPlain_0,
    _aPlain_1,
    _aPlain_2,
};
void LCD_X_Config(void) {
    //
    // Set display driver and color conversion for 1st layer
    //
    GUI_DEVICE_CreateAndLink(GUIDRV_BITPLAINS, COLOR_CONVERSION, 0, 0);
    //
    // Display driver configuration
    //
    if (LCD_GetSwapXY()) {
        LCD_SetSizeEx (0, YSIZE_PHYS, XSIZE_PHYS);
        LCD_SetVSizeEx(0, YSIZE_PHYS, XSIZE_PHYS);
    } else {
        LCD_SetSizeEx (0, XSIZE_PHYS, YSIZE_PHYS);
        LCD_SetVSizeEx(0, XSIZE_PHYS, YSIZE_PHYS);
    }
    //
    // Initialize VRAM access of the driver
    //
    LCD_SetVRAMAddrEx(0, (void *)&_VRAM_Desc);
}
```



## 13.7.2 GUIDRV\_Dist

GUIDRV\_Dist has been developed to support displays with multiple controllers. It is able to support multiple display areas each driven by a separate display controller. The distribution driver passes the drawing operations to the according display driver. This also works with overlapping operations. In these cases the operations are divided into sub operations for each affected controller. GUIDRV\_Dist is part of the emWin basic package.

### 13.7.2.1 Supported hardware

The distribution driver is able to work with each runtime configurable display driver. Please note that it is required that each of the configured display drivers use the same color conversion as the distribution driver.

### 13.7.2.2 Driver selection

To be able to use this driver the following call has to be made:

```
pDevice = GUI_DEVICE_CreateAndLink(GUIDRV_DIST, COLOR_CONVERSION, 0, Layer);
```

### 13.7.2.3 RAM requirements

None.

### 13.7.2.4 Run-time configuration

After the driver has been created the actual display drivers should be also created and added to the distribution device:

```
pDevice0 = GUI_DEVICE_Create(DISPLAY_DRIVER, COLOR_CONVERSION, 0, -1);  
pDevice1 = GUI_DEVICE_Create(DISPLAY_DRIVER, COLOR_CONVERSION, 0, -1);  
GUIDRV_Dist_AddDriver(pDevice, pDevice0, &Rect0);  
GUIDRV_Dist_AddDriver(pDevice, pDevice1, &Rect1);
```

### 13.7.2.5 GUIDRV\_Dist\_AddDriver()

#### Description

Adds a display driver to the distribution driver.

#### Prototype

```
void GUIDRV_Dist_AddDriver(GUI_DEVICE * pDevice,
                          GUI_DEVICE * pDriver,
                          GUI_RECT   * pRect);
```

#### Parameters

Parameter	Description
<code>pDevice</code>	Pointer to the already created distribution device.
<code>pDriver</code>	Pointer to the already created driver device to be added.
<code>pRect</code>	Pointer to the rectangle in which outputs have to affect the driver.

#### Configuration example

```
void LCD_X_Config(void) {
    //
    // Set display driver and color conversion for 1st layer
    //
    pDevice = GUI_DEVICE_CreateAndLink(GUIDRV_DIST, COLOR_CONVERSION, 0, 0);
    //
    // Display size configuration
    //
    LCD_SetSizeEx (0, XSIZE_PHYS, YSIZE_PHYS);
    LCD_SetVSizeEx(0, VXSIZE_PHYS, VYSIZE_PHYS);
    //
    // Create first display driver
    //
    pDevice0 = GUI_DEVICE_Create(DISPLAY_DRIVER, COLOR_CONVERSION, 0, -1);
    //
    // Configuration of first driver
    //
    ...
    //
    // Create second display driver
    //
    pDevice1 = GUI_DEVICE_Create(DISPLAY_DRIVER, COLOR_CONVERSION, 0, -1);
    //
    // Configuration of second driver
    //
    ...
    //
    // Add display drivers to distribution driver
    //
    Rect0.x0 = 0;
    Rect0.y0 = 160;
    Rect0.x1 = 223;
    Rect0.y1 = 319;
    GUIDRV_Dist_AddDriver(pDevice, pDevice0, &Rect0);
    Rect1.x0 = 0;
    Rect1.y0 = 0;
    Rect1.x1 = 223;
    Rect1.y1 = 159;
    GUIDRV_Dist_AddDriver(pDevice, pDevice1, &Rect1);
}
```

### 13.7.3 GUIDRV\_FlexColor

#### 13.7.3.1 Supported hardware

##### Controllers

The supported display controllers are listed in the description of the function *GUIDRV\_FlexColor\_SetFunc* on page 3295.

##### Bits per pixel

Supported color depth is 16, 18 and 24 bpp.

##### Interfaces

The driver supports 8-bit, 9-bit, 16-bit and 18-bit indirect interface.

#### 13.7.3.2 Driver selection

To be able to use this driver the following call has to be made:

```
pDevice = GUI_DEVICE_CreateAndLink(GUIDRV_FLEXCOLOR, COLOR_CONVERSION, 0, Layer);
```

Detailed information about palette modes can be found in the chapter *Colors* on page 604.

#### 13.7.3.3 Display data RAM organization

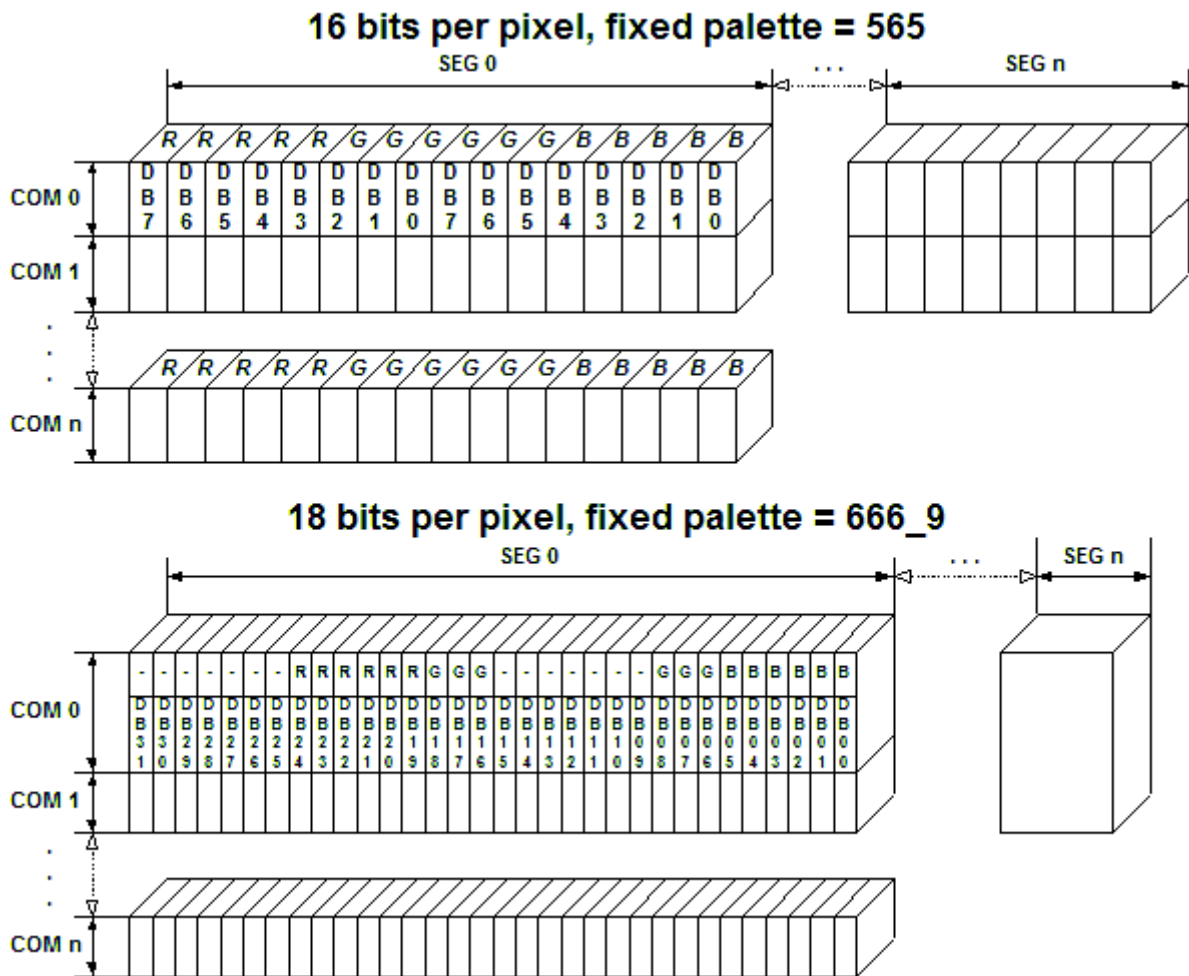

### 13.7.3.4 RAM requirements

This display driver requires approx. 500 Bytes to work and a line buffer. The size of the line buffer gets calculated as follow:

```
LCD_XSIZE * ((BitsPerPixel + 7) / 8)
```

It can also be used with and without a display data cache, containing a complete copy of the content of the display data RAM. The amount of memory used by the cache is:

```
LCD_XSIZE * LCD_YSIZE * BytesPerPixel
```

BytesPerPixel is 2 for 16bpp mode and 4 for 18bpp mode. Using a cache avoids reading operations from the display controller in case of XOR drawing operations and further it speeds up string output operations.

### 13.7.3.5 Run-time configuration API

The following table lists the available run-time configuration routines:

Routine	Description
<a href="#">LCD_SetDevFunc()</a>	The function sets additional and / or user defined functions of the display driver.

### 13.7.3.6 Commands supported by LCD\_SetDevFunc()

Command	Description
<a href="#">LCD_DEVFUNC_READMPIXELS</a>	Can be used to set a custom defined routine for reading multiple pixels from the display controller.
<a href="#">LCD_DEVFUNC_READPIXEL</a>	Can be used to set a custom defined routine for reading a single pixel from the display controller.

Further information about the LCD layer routines can be found under *Display driver API* on page 3426.

#### Important note on reading back pixel data from the controller

Because of the plurality of the supported display controllers and their operation modes the driver has not been tested with each interface of each supported controller. The behavior of the controller when reading back pixel data often depends on custom configuration and hardware details. Because of that it could happen, that the driver has no appropriate reading function(s) available. In that case the above explained function [LCD\\_SetDevFunc\(\)](#) can be used to set application defined functions for reading back pixel data.

The main problem for the driver here is not getting data from the driver. Getting the color bits in the right order is the problem here. The custom defined functions need to supply 'pixel index' values. This index format needs to comply to the index format determined by the color conversion routines configured for the driver device. Because the data supplied by the hardware interface functions of the driver in most cases does not have the right index format, the reading routines need to convert that raw data into the required pixel index format determined by the driver device configuration. For details about the hardware interface functions please also refer to [GUIDRV\\_FlexColor\\_SetFunc\(\)](#) and its parameter `pHW_API`. For details about the pixel index format please also refer to [GUI\\_DEVICE\\_CreateAndLink\(\)](#) and its parameter `pColorConvAPI` and the chapter *Colors* on page 604. A sample configuration which shows how custom reading functions can be achieved is available in the configuration file sample folder shipped with the driver.

### 13.7.3.7 Configuration API

Routine	Description
Common configuration routines	
<code>GUIDRV_FlexColor_SetFunc()</code>	Configures bus, cache, and hardware routines.
<code>GUIDRV_FlexColor_Config()</code>	Configures orientation and offset of the SEG- and COM-lines.
<code>GUIDRV_FlexColor_SetOrientation()</code>	Sets a new orientation for the given layer.
Detailed interface selection	
<code>GUIDRV_FlexColor_SetInterface66712_B9()</code>	Set up bus interface (TYPE_I, TYPE_II).
<code>GUIDRV_FlexColor_SetInterface66712_B18()</code>	Set up bus interface (TYPE_I, TYPE_II).
<code>GUIDRV_FlexColor_SetInterface66715_B9()</code>	Set up bus interface (TYPE_I, TYPE_II).
<code>GUIDRV_FlexColor_SetInterface66715_B18()</code>	Set up bus interface (TYPE_I, TYPE_II).
Configuration of read back function	
<code>GUIDRV_FlexColor_SetReadFunc66709_B16()</code>	Read back function settings.
<code>GUIDRV_FlexColor_SetReadFunc66712_B9()</code>	Read back function settings.
<code>GUIDRV_FlexColor_SetReadFunc66712_B16()</code>	Read back function settings.
<code>GUIDRV_FlexColor_SetReadFunc66715_B9()</code>	Read back function settings.
<code>GUIDRV_FlexColor_SetReadFunc66715_B16()</code>	Read back function settings.
<code>GUIDRV_FlexColor_SetReadFunc66720_B16()</code>	Read back function settings.
<code>GUIDRV_FlexColor_SetReadFunc66772_B8()</code>	Read back function settings.
<code>GUIDRV_FlexColor_SetReadFunc66772_B16()</code>	Read back function settings.

The above set of configuration functions set up the detailed behavior of the driver. In short they do the following:

#### **GUIDRV\_FlexColor\_SetFunc()**

Configures the LCD-controller to be used, color depth and cache settings.

#### **GUIDRV\_FlexColor\_Config()**

Configures display orientation, dummy reads and first SEG- and COM-lines.

#### **GUIDRV\_FlexColor\_SetInterface()**

Configures the bus interface to be used.

#### **GUIDRV\_FlexColor\_SetReadFunc()**

Configures the behavior when reading back pixel data.

#### **Calling sequence**

The following shows a recommended sequence of configuration function calls:

```

GUI_DEVICE_CreateAndLink()
GUIDRV_FlexColor_Config()
LCD_SetSizeEx()
LCD_SetVSizeEx()
GUIDRV_FlexColor_SetInterface()

```

```
GUIDRV_FlexColor_SetReadFunc()  
GUIDRV_FlexColor_SetFunc()
```

### 13.7.3.7.1 GUIDRV\_FlexColor\_SetFunc()

#### Description

Configures bus width, cache usage and hardware routines.

#### Prototype

```
void GUIDRV_FlexColor_SetFunc(GUI_DEVICE * pDevice,
                              GUI_PORT_API * pHW_API,
                              void        ( *pfFunc)(GUI_DEVICE * ),
                              void        ( *pfMode)(GUI_DEVICE * ));
```

#### Parameters

Parameter	Description
<code>pDevice</code>	Pointer to the driver device structure.
<code>pHW_API</code>	Pointer to a <code>GUI_PORT_API</code> structure. See required routines below.
<code>pfFunc</code>	Controller selection macro. See table below.
<code>pfMode</code>	See table below.

Permitted values for parameter <code>pfFunc</code> Supported display controller	
<code>GUIDRV_FLEXCOLOR_F66702</code>	Set up the driver to use one of the following controllers: <ul style="list-style-type: none"> <li>Solomon SSD1284, SSD1289, SSD1298</li> </ul>
<code>GUIDRV_FLEXCOLOR_F66708</code>	Set up the driver to use one of the following controllers: <ul style="list-style-type: none"> <li>FocalTech FT1509</li> <li>Ilitek ILI9320, ILI9325, ILI9328, ILI9335</li> <li>LG Electronics LGDP4531, LGDP4551</li> <li>OriseTech SPFD5408</li> <li>Renesas R61505, R61580</li> </ul>
<code>GUIDRV_FLEXCOLOR_F66709</code>	Set up the driver to use one of the following controllers: <ul style="list-style-type: none"> <li>Epson S1D19122</li> <li>Himax HX8353, HX8325A, HX8357, HX8369</li> <li>Ilitek ILI9338, ILI9340, ILI9341, ILI9342, ILI9163, ILI9481, ILI9486, ILI9488, ILI9806H</li> <li>Lucid Display Technology LDT7138</li> <li>Novatek NT39122</li> <li>Orisetech SPFD54124C, SPFD5414D</li> <li>Renesas R61516, R61526</li> <li>Sitronix ST7628, ST7637, ST7687, ST7715, ST7735, ST7789, ST7796</li> <li>Solomon SSD1355</li> </ul>
<code>GUIDRV_FLEXCOLOR_F66712</code>	Set up the driver to use one of the following controllers: <ul style="list-style-type: none"> <li>Himax HX8340, HX8347, HX8352, HX8367</li> </ul>
<code>GUIDRV_FLEXCOLOR_F66714</code>	Set up the driver to use the following controller: <ul style="list-style-type: none"> <li>Solomon SSD2119</li> </ul>
<code>GUIDRV_FLEXCOLOR_F66715</code>	Set up the driver to use one of the following controllers: <ul style="list-style-type: none"> <li>Himax HX8352B</li> </ul>
<code>GUIDRV_FLEXCOLOR_F66718</code>	Set up the driver to use the following controller: <ul style="list-style-type: none"> <li>Syncoam SEPS525</li> </ul>
<code>GUIDRV_FLEXCOLOR_F66719</code>	Set up the driver to use the following controller: <ul style="list-style-type: none"> <li>Samsung S6E63D6</li> </ul>
<code>GUIDRV_FLEXCOLOR_F66720</code>	Set up the driver to use one of the following controllers: <ul style="list-style-type: none"> <li>Solomon SSD1961, SSD1963</li> </ul>
<code>GUIDRV_FLEXCOLOR_F66721</code>	Set up the driver to use one of the following controller:

	<ul style="list-style-type: none"> <li>RAIO RA8870, RA8875</li> </ul>
GUIDRV_FLEXCOLOR_F66722	Set up the driver to use one of the following controller: <ul style="list-style-type: none"> <li>Solomon SSD1351, SSD1353</li> </ul>
GUIDRV_FLEXCOLOR_F66723	Set up the driver to use one of the following controller: <ul style="list-style-type: none"> <li>Lucid Display Technology LDT7138</li> </ul>
GUIDRV_FLEXCOLOR_F66724	Set up the driver to use one of the following controllers: <ul style="list-style-type: none"> <li>Sitronix ST7775</li> </ul>
GUIDRV_FLEXCOLOR_F66725	Set up the driver to use one of the following controllers: <ul style="list-style-type: none"> <li>UltraChip UC1698</li> </ul>
GUIDRV_FLEXCOLOR_F66772	Set up the driver to use one of the following controllers: <ul style="list-style-type: none"> <li>Himax HX8301</li> <li>Ilitek ILI9220, ILI9221</li> <li>LG Electronics LGDP4525</li> <li>Samsung S6D0117</li> <li>Sitronix ST7712</li> <li>Hitachi HD66772</li> </ul>

The display controllers listed in the table above are the currently known controllers compatible to the driver. Please note that the used numbers of the selection macros are compatible to some of the LCD\_CONTROLLER macro of the driver GUIDRV\_CompactColor\_16. This makes it easy to migrate from the compile time configurable GUIDRV\_CompactColor\_16 to the runtime configurable GUIDRV\_FlexColor.

Permitted values for parameter <code>pfMode</code>	
GUIDRV_FLEXCOLOR_M16C0B8	16bpp, no cache, 8 bit bus
GUIDRV_FLEXCOLOR_M16C1B8	16bpp, cache, 8 bit bus
GUIDRV_FLEXCOLOR_M16C0B16	16bpp, no cache, 16 bit bus
GUIDRV_FLEXCOLOR_M16C1B16	16bpp, cache, 16 bit bus
GUIDRV_FLEXCOLOR_M18C0B9	18bpp, no cache, 9 bit bus
GUIDRV_FLEXCOLOR_M18C1B9	18bpp, cache, 9 bit bus
GUIDRV_FLEXCOLOR_M18C0B18	18bpp, no cache, 18 bit bus
GUIDRV_FLEXCOLOR_M18C1B18	18bpp, cache, 18 bit bus
GUIDRV_FLEXCOLOR_M24C0B8	24bpp, no cache, 8 bit bus

Each controller selection supports different operation modes. The table below shows the supported modes for each controller:

Selection macro	M16C0B8	M16C1B8	M16C0B16	M16C1B16	M18C0B9	M18C1B9	M18C0B18	M18C1B18	M24C0B8
GUIDRV_FLEXCOLOR_F66702	X	X	X	X	-	-	-	-	-
GUIDRV_FLEXCOLOR_F66708	X	X	X	X	-	-	-	-	-
GUIDRV_FLEXCOLOR_F66709	X	X	X	X	X	X	-	-	X
GUIDRV_FLEXCOLOR_F66712	X	X	X	X	X	X	X	X	-
GUIDRV_FLEXCOLOR_F66714	X	X	X	X	X	X	-	-	-
GUIDRV_FLEXCOLOR_F66715	X	X	X	X	X	X	X	X	-
GUIDRV_FLEXCOLOR_F66718	X	X	X	X	X	X	-	-	-
GUIDRV_FLEXCOLOR_F66719	X	X	X	X	-	-	-	-	-
GUIDRV_FLEXCOLOR_F66720	X	X	X	X	-	-	-	-	X
GUIDRV_FLEXCOLOR_F66721	X	X	X	X	-	-	-	-	-
GUIDRV_FLEXCOLOR_F66722	X	X	-	-	-	-	-	-	-



Selection macro	M16C0B8	M16C1B8	M16C0B16	M16C1B16	M18C0B9	M18C1B9	M18C0B18	M18C1B18	M24C0B8
GUIDRV_FLEXCOLOR_F66723	X	X	-	-	-	-	-	-	-
GUIDRV_FLEXCOLOR_F66724	X	X	X	X	-	-	-	-	-
GUIDRV_FLEXCOLOR_F66725	X	X	-	-	-	-	-	-	-
GUIDRV_FLEXCOLOR_F66772	X	X	X	X	-	-	-	-	-

### Legend

X	supported
-	not supported

#### 13.7.3.7.1.1 Required GUI\_PORT\_API routines

The required GUI\_PORT\_API routines depend on the used interface. If a cache is used the routines for reading data are unnecessary for each interface:

##### 8 bit interface

Element	Data type
<a href="#">pfWrite8_A0</a>	void (*)(U8 Data)
<a href="#">pfWrite8_A1</a>	void (*)(U8 Data)
<a href="#">pfWriteM8_A1</a>	void (*)(U8 * pData, int NumItems)
<a href="#">pfRead8_A1</a>	U8 (*)(void)
<a href="#">pfReadM8_A1</a>	void (*)(U8 * pData, int NumItems)

##### 16 bit interface

Element	Data type
<a href="#">pfWrite16_A0</a>	void (*)(U16 Data)
<a href="#">pfWrite16_A1</a>	void (*)(U16 Data)
<a href="#">pfWriteM16_A1</a>	void (*)(U16 * pData, int NumItems)
<a href="#">pfRead16_A1</a>	U16 (*)(void)
<a href="#">pfReadM16_A1</a>	void (*)(U16 * pData, int NumItems)

##### 18 bit interface

Element	Data type
<a href="#">pfWrite32_A0</a>	void (*)(U32 Data)
<a href="#">pfWrite32_A1</a>	void (*)(U32 Data)
<a href="#">pfWriteM32_A1</a>	void (*)(U32 * pData, int NumItems)
<a href="#">pfRead32_A1</a>	U32 (*)(void)
<a href="#">pfReadM32_A1</a>	void (*)(U32 * pData, int NumItems)

##### 9 bit interface

The following describes the behavior of the 9 bit bus variant of the driver. When working with a 9 bit interface the display controller uses the lines D17-D10 or lines D7-D0 (8 bit) for accessing the command register and D17-D9 or D8-D0 (9 bit) for passing data. This means the lines D17-D9 or D8-D0 are connected to the interface lines of the CPU.

The driver passes 16 bit values to the hardware routines. In dependence of the selected driver interface (`TYPE_I` or `TYPE_II`) the bits 7-0 (`TYPE_I`) or the bits 8-1 (`TYPE_II`) already contain the right values to be passed to the controller. No further shift operation is required in the hardware routines.

To be able to process pixel data as fast as possible, the driver passes two 16 bit data values per pixel (0000000R RRRRRGGG and 0000000G GBBBBBBB) to the hardware routines. Only the first 9 bits contain pixel data. So nothing need to be shifted in the hardware routines. In case of using the 9 bit interface the driver requires 16 bit hardware routines for communicating with the controller.

Element	Data type	Description
<code>pfWrite16_A0</code>	<code>void (*)(U16 Data)</code>	Routine used to set up the index register. Dependent on used bus interface DB8-DB1 or DB7-DB0 are used.
<code>pfWrite16_A1</code>	<code>void (*)(U16 Data)</code>	Routine used to pass register parameters. Dependent on used bus interface DB8-DB1 or DB7-DB0 are used.
<code>pfWriteM16_A1</code>	<code>void (*)(U16 * pData, int NumItems)</code>	Data to be written (DB0-DB9)
<code>pfReadM16_A1</code>	<code>void (*)(U16 * pData, int NumItems)</code>	Data read (DB0-DB9)

### 13.7.3.7.1.2 GUIDRV\_FLEXCOLOR\_F66721

In addition to the hardware interface functions described above, the driver requires the following functions in case it is configured for a 66721-type controller. These controllers require reading the controller status. According to the used interface these functions are:

#### 8 bit interface

Element	Data type
<code>pfRead8_A0</code>	<code>U8 (*)(void);</code>

#### 16 bit interface

Element	Data type
<code>pfRead16_A0</code>	<code>U16 (*)(void);</code>

Further these controllers do not support setting the orientation by the driver using `GUIDRV_FlexColor_Config()`. This needs to be done in the initialization by setting the Display Configuration Register `0x20` (DPCR) accordingly.

### 13.7.3.7.2 GUIDRV\_FlexColor\_Config()

#### Description

Configures orientation and offset of the SEG- and COM-lines.

#### Prototype

```
void GUIDRV_FlexColor_Config(GUI_DEVICE      * pDevice,
                             CONFIG_FLEXCOLOR * pConfig);
```

#### Parameters

Parameter	Description
<code>pDevice</code>	Pointer to the device to configure.
<code>pConfig</code>	Pointer to a <code>CONFIG_FLEXCOLOR</code> structure. See element list below.

#### Elements of structure `CONFIG_FLEXCOLOR`

Data type	Element	Description
int	FirstSEG	First segment line.
int	FirstCOM	First common line.
int	Orientation	One or more "OR"-combined values of the values to be found under <i>Orientation flags</i> on page 3280.
U16	RegEntryMode	Normally the display controller uses 3 bits of one register to define the required display orientation. Normally these are the bits ID0, ID1 and AM. To be able to control the content of the other bits the RegEntryMode element can be used. The driver combines this value with the required orientation bits during the initialization process.
int	NumDummyReads	Defines the number of reading operations which have to be done until valid data can be retrieved. Please note that only values $\neq 0$ are accepted. If the controller does not need one or more dummy reads, -1 should be used here.

Permitted values for parameter Orientation	
GUI_MIRROR_X	Mirroring the X-axis
GUI_MIRROR_Y	Mirroring the Y-axis
GUI_SWAP_XY	Swapping X- and Y-axis

### 13.7.3.7.3 GUIDRV\_FlexColor\_SetOrientation()

#### Description

Sets the orientation of the screen when using GUIDRV\_FlexColor.

#### Prototype

```
int GUIDRV_FlexColor_SetOrientation(int Orientation,  
                                   int LayerIndex);
```

#### Parameters

Parameter	Description
<code>Orientation</code>	The orientation to be used.
<code>LayerIndex</code>	The index of the layer the orientation should be set for.

**13.7.3.7.4 GUIDRV\_FlexColor\_SetInterface66712\_B9()****13.7.3.7.5 GUIDRV\_FlexColor\_SetInterface66715\_B9()****Description**

Sets the type of interface to be used.

**Prototypes**

```
void GUIDRV_FlexColor_SetInterface66712_B9(GUI_DEVICE * pDevice,
                                           int          Type);

void GUIDRV_FlexColor_SetInterface66715_B9(GUI_DEVICE * pDevice,
                                           int          Type);
```

**Parameters**

Parameter	Description
<code>pDevice</code>	Pointer to the device to configure.
<code>Type</code>	Type of the interface to be used. See possible types below.

Permitted values for parameter Type	
<code>GUIDRV_FLEXCOLOR_IF_TYPE_I</code>	Uses lines DB7-DB0 for register access and lines DB8-DB0 for data access. (default)
<code>GUIDRV_FLEXCOLOR_IF_TYPE_II</code>	Uses lines DB8 to DB1 for register access and lines DB8-DB0 for data access.

**Additional information**

The difference between the interfaces affects the register access to the controller. Normally there are 2 kinds of possible interfaces available when working with the 18 bit bus interface. `TYPE_I` uses the lines D7 to D0 for register access whereas `TYPE_II` uses the lines D8 to D1.

**13.7.3.7.6 GUIDRV\_FlexColor\_SetInterface66712\_B18()****13.7.3.7.7 GUIDRV\_FlexColor\_SetInterface66715\_B18()****Description**

Sets the type of interface to be used.

**Prototypes**

```
void GUIDRV_FlexColor_SetInterface66712_B18(GUI_DEVICE * pDevice,
                                             int          Type);

void GUIDRV_FlexColor_SetInterface66715_B18(GUI_DEVICE * pDevice,
                                             int          Type);
```

**Parameters**

Parameter	Description
<code>pDevice</code>	Pointer to the device to configure.
<code>Type</code>	Type of the interface to be used. See possible types below.

Permitted values for parameter Type	
<code>GUIDRV_FLEXCOLOR_IF_TYPE_I</code>	Uses lines DB7-DB0 for register access and lines DB8-DB0 for data access. (default)
<code>GUIDRV_FLEXCOLOR_IF_TYPE_II</code>	Uses lines DB8 to DB1 for register access and lines DB8-DB0 for data access.

**Additional information**

The difference between the interfaces affects the register access to the controller. Normally there are 2 kinds of possible interfaces available when working with the 18 bit bus interface. `TYPE_I` uses the lines D7 to D0 for register access whereas `TYPE_II` uses the lines D8 to D1.

### 13.7.3.7.8 GUIDRV\_FlexColor\_SetReadFunc66709\_B16()

#### Description

Sets the function(s) to be used for reading back pixel data. To be called before `GUIDRV_FlexColor_SetFunc()`.

#### Prototype

```
void GUIDRV_FlexColor_SetReadFunc66709_B16(GUI_DEVICE * pDevice,
                                           int          Func);
```

#### Parameters

Parameter	Description
<code>pDevice</code>	Pointer to the device to configure.
<code>Func</code>	Type of the interface to be used. See possible types below.

Permitted values for parameter <code>Func</code>	
<code>GUIDRV_FLEXCOLOR_READ_FUNC_I</code>	3 cycles and data conversion required. (default)
<code>GUIDRV_FLEXCOLOR_READ_FUNC_II</code>	2 cycles and no conversion required.
<code>GUIDRV_FLEXCOLOR_READ_FUNC_III</code>	3 cycles and data conversion required.

#### Additional information

The difference between the interfaces affects only reading back pixels. The right interface depends on the used controller.

#### GUIDRV\_FLEXCOLOR\_READ\_FUNC\_I

Cycle	D15	D14	D13	D12	D11	D10	D9	D8	D7	D6	D5	D4	D3	D2	D1	D0
1st	Dummy read															
2nd	-	-	-	-	-	-	-	-	B4	B3	B2	B1	B0	-	-	-
3rd	G5	G4	G3	G2	G1	G0	-	-	R4	R3	R2	R1	R0	-	-	-

In dependence of controller settings red and blue could be swapped.

#### GUIDRV\_FLEXCOLOR\_READ\_FUNC\_II

Cycle	D15	D14	D13	D12	D11	D10	D9	D8	D7	D6	D5	D4	D3	D2	D1	D0
1st	Dummy read															
2nd	B4	B3	B2	B1	B0	G5	G4	G3	G2	G1	G0	R4	R3	R2	R1	R0

In dependence of controller settings red and blue could be swapped.

**GUIDRV\_FLEXCOLOR\_READ\_FUNC\_III**

Cycle	D15	D14	D13	D12	D11	D10	D9	D8	D7	D6	D5	D4	D3	D2	D1	D0
1st	Dummy read															
2nd	B4	B3	B2	B1	B0	-	-	-	G5	G4	G3	G2	G1	G0	-	-
3rd	R4	R3	R2	R1	R0	-	-	-	-	-	-	-	-	-	-	-

In dependence of controller settings red and blue could be swapped.



### 13.7.3.7.9 GUIDRV\_FlexColor\_SetReadFunc66712\_B9()

### 13.7.3.7.10 GUIDRV\_FlexColor\_SetReadFunc66715\_B9()

#### Description

Sets the function(s) to be used for reading back pixel data. To be called before `GUIDRV_FlexColor_SetFunc()`.

#### Prototypes

```
void GUIDRV_FlexColor_SetReadFunc66712_B9(GUI_DEVICE * pDevice,
                                           int          Func);
```

```
void GUIDRV_FlexColor_SetReadFunc66715_B9(GUI_DEVICE * pDevice,
                                           int          Func);
```

#### Parameters

Parameter	Description
<code>pDevice</code>	Pointer to the device to configure.
<code>Type</code>	Type of the interface to be used. See possible types below.

Permitted values for parameter Func	
<code>GUIDRV_FLEXCOLOR_READ_FUNC_I</code>	3 cycles and data conversion required. (default)
<code>GUIDRV_FLEXCOLOR_READ_FUNC_II</code>	3 cycles and data conversion required.

#### Additional information

The right function to be used depends on the behavior of the used controller.

#### GUIDRV\_FLEXCOLOR\_READ\_FUNC\_I

Cycle	D15	D14	D13	D12	D11	D10	D9	D8	D7	D6	D5	D4	D3	D2	D1	D0
1st	Dummy read															
2nd	-	-	-	-	-	-	-	B5	B4	B3	B2	B1	B0	G5	G4	G3
3rd	-	-	-	-	-	-	-	G2	G1	G0	R5	R4	R3	R2	R1	R0

In dependence of controller settings red and blue could be swapped.

#### GUIDRV\_FLEXCOLOR\_READ\_FUNC\_II

Cycle	D15	D14	D13	D12	D11	D10	D9	D8	D7	D6	D5	D4	D3	D2	D1	D0
1st	Dummy read															
2nd	B5	B4	B3	B2	B1	B0	-	-	G5	G4	G3	G2	G1	G0	-	-
3rd	R5	R4	R3	R2	R1	R0	-	-	-	-	-	-	-	-	-	-

In dependence of controller settings red and blue could be swapped.

**13.7.3.7.11 GUIDRV\_FlexColor\_SetReadFunc66712\_B16()****13.7.3.7.12 GUIDRV\_FlexColor\_SetReadFunc66715\_B16()****Description**

Sets the function(s) to be used for reading back pixel data. To be called before `GUIDRV_FlexColor_SetFunc()`.

**Prototype**

```
void GUIDRV_FlexColor_SetReadFunc66712_B16(GUI_DEVICE * pDevice,
                                             int          Func);
```

```
void GUIDRV_FlexColor_SetReadFunc66715_B16(GUI_DEVICE * pDevice,
                                             int          Func);
```

**Parameters**

Parameter	Description
<code>pDevice</code>	Pointer to the device to configure.
<code>Type</code>	Type of the interface to be used. See possible types below.

**Permitted values for parameter Func**

<code>GUIDRV_FLEXCOLOR_READ_FUNC_I</code>	4 cycles and data conversion required. (default)
<code>GUIDRV_FLEXCOLOR_READ_FUNC_II</code>	4 cycles and data conversion required.
<code>GUIDRV_FLEXCOLOR_READ_FUNC_III</code>	3 cycles and data conversion required.

**Additional information**

The right function to be used depends on the behavior of the used controller.

**GUIDRV\_FLEXCOLOR\_READ\_FUNC\_I**

Cycle	D15	D14	D13	D12	D11	D10	D9	D8	D7	D6	D5	D4	D3	D2	D1	D0
1st	Dummy read															
2nd	-	-	-	-	-	-	-	-	B4	B3	B2	B1	B0	-	-	-
3rd	-	-	-	-	-	-	-	-	G5	G4	G3	G2	G1	G0	-	-
4th	-	-	-	-	-	-	-	-	R4	R3	R2	R1	R0	-	-	-

In dependence of controller settings red and blue could be swapped.

**GUIDRV\_FLEXCOLOR\_READ\_FUNC\_II**

Cycle	D15	D14	D13	D12	D11	D10	D9	D8	D7	D6	D5	D4	D3	D2	D1	D0
1st	Dummy read															
2nd	-	-	-	-	-	-	-	-	G5	G4	G3	G2	G1	G0	-	-
3rd	-	-	-	-	-	-	-	-	B4	B3	B2	B1	B0	-	-	-

Cycle	D15	D14	D13	D12	D11	D10	D9	D8	D7	D6	D5	D4	D3	D2	D1	D0
4th	-	-	-	-	-	-	-	-	R4	R3	R2	R1	R0	-	-	-

In dependence of controller settings red and blue could be swapped.

### **GUIDRV\_FLEXCOLOR\_READ\_FUNC\_III**

Cycle	D15	D14	D13	D12	D11	D10	D9	D8	D7	D6	D5	D4	D3	D2	D1	D0
1st	Dummy read															
2nd	B4	B3	B2	B1	B0	-	-	-	G5	G4	G3	G2	G1	G0	-	-
3rd	R4	R3	R2	R1	R0	-	-	-	-	-	-	-	-	-	-	-

In dependence of controller settings red and blue could be swapped.

### 13.7.3.7.13 GUIDRV\_FlexColor\_SetReadFunc66720\_B16()

#### Description

Sets the function(s) to be used for reading back pixel data. To be called before `GUIDRV_FlexColor_SetFunc()`.

#### Prototype

```
void GUIDRV_FlexColor_SetReadFunc66720_B16(GUI_DEVICE * pDevice,
                                           int          Func);
```

#### Parameters

Parameter	Description
<code>pDevice</code>	Pointer to the device to configure.
<code>Type</code>	<code>Type</code> of the interface to be used. See possible types below.

Permitted values for parameter Func	
<code>GUIDRV_FLEXCOLOR_READ_FUNC_I</code>	3 cycles and data conversion required. (default)
<code>GUIDRV_FLEXCOLOR_READ_FUNC_II</code>	2 cycles and no conversion required.

#### Additional information

The right function to be used depends on the behavior of the used controller. Whereas `...FUNC_I` extracts the index value by assembling it from the second and third word received from the controller, `...FUNC_II` uses the second word as it is. Please note that the right interface depends on the behavior of the used controller.

#### GUIDRV\_FLEXCOLOR\_READ\_FUNC\_I

Cycle	D15	D14	D13	D12	D11	D10	D9	D8	D7	D6	D5	D4	D3	D2	D1	D0
1st	Dummy read															
2nd	-	-	-	-	-	-	-	-	B4	B3	B2	B1	B0	-	-	-
3rd	G5	G4	G3	G2	G1	G0	-	-	R4	R3	R2	R1	R0	-	-	-

In dependence of controller settings red and blue could be swapped.

#### GUIDRV\_FLEXCOLOR\_READ\_FUNC\_II

Cycle	D15	D14	D13	D12	D11	D10	D9	D8	D7	D6	D5	D4	D3	D2	D1	D0
1st	Dummy read															
2nd	B4	B3	B2	B1	B0	G5	G4	G3	G2	G1	G0	R4	R3	R2	R1	R0

In dependence of controller settings red and blue could be swapped.

### 13.7.3.7.14 GUIDRV\_FlexColor\_SetReadFunc66772\_B8()

#### Description

Sets the function(s) to be used for reading back pixel data. To be called before `GUIDRV_FlexColor_SetFunc()`.

#### Prototype

```
void GUIDRV_FlexColor_SetReadFunc66772_B8(GUI_DEVICE * pDevice,
                                           int          Func);
```

#### Parameters

Parameter	Description
<code>pDevice</code>	Pointer to the device to configure.
<code>Type</code>	<code>Type</code> of the interface to be used. See possible types below.
Permitted values for parameter Func	
<code>GUIDRV_FLEXCOLOR_READ_FUNC_I</code>	3 cycles and no conversion required. (default)
<code>GUIDRV_FLEXCOLOR_READ_FUNC_II</code>	3 cycles and conversion required.

#### Additional information

The right function to be used depends on the behavior of the used controller. Whereas `..._FUNC_I` extracts the index value by assembling it from the second and third word received from the controller, `..._FUNC_II` uses the second word as it is. Please note that the right interface depends on the behavior of the used controller.

#### GUIDRV\_FLEXCOLOR\_READ\_FUNC\_I

Cycle	D7	D6	D5	D4	D3	D2	D1	D0
1st	Dummy read							
2nd	B4	B3	B2	B1	B0	G5	G4	G3
3rd	G2	G1	G0	R4	R3	R2	R1	R0

In dependence of controller settings red and blue could be swapped.

#### GUIDRV\_FLEXCOLOR\_READ\_FUNC\_II

Cycle	D7	D6	D5	D4	D3	D2	D1	D0
1st	Dummy read							
2nd	R4	R3	R2	R1	R0	G5	G4	G3
3rd	G2	G1	G0	B4	B3	B2	B1	B0

In dependence of controller settings red and blue could be swapped.

### 13.7.3.7.15 GUIDRV\_FlexColor\_SetReadFunc66772\_B16()

#### Description

Sets the function(s) to be used for reading back pixel data. To be called before `GUIDRV_FlexColor_SetFunc()`.

#### Prototype

```
void GUIDRV_FlexColor_SetReadFunc66772_B16(GUI_DEVICE * pDevice,
                                           int          Func);
```

#### Parameters

Parameter	Description
<code>pDevice</code>	Pointer to the device to configure.
<code>Type</code>	<code>Type</code> of the interface to be used. See possible types below.
Permitted values for parameter Func	
<code>GUIDRV_FLEXCOLOR_READ_FUNC_I</code>	2 cycles and no conversion required. (default)
<code>GUIDRV_FLEXCOLOR_READ_FUNC_II</code>	2 cycles and conversion required.

#### Additional information

The right function to be used depends on the behavior of the used controller. Whereas `..._FUNC_I` extracts the index value by assembling it from the second and third word received from the controller, `..._FUNC_II` uses the second word as it is. Please note that the right interface depends on the behavior of the used controller.

#### GUIDRV\_FLEXCOLOR\_READ\_FUNC\_I

Cycle	D15	D14	D13	D12	D11	D10	D9	D8	D7	D6	D5	D4	D3	D2	D1	D0
1st	Dummy read															
2nd	B4	B3	B2	B1	B0	G5	G4	G3	G2	G1	G0	R4	R3	R2	R1	R0

#### GUIDRV\_FLEXCOLOR\_READ\_FUNC\_II

Cycle	D15	D14	D13	D12	D11	D10	D9	D8	D7	D6	D5	D4	D3	D2	D1	D0
1st	Dummy read															
2nd	R4	R3	R2	R1	R0	G5	G4	G3	G2	G1	G0	B4	B3	B2	B1	B0

In dependence of controller settings red and blue can be swapped.

## 13.7.4 GUIDRV\_IST3088

### 13.7.4.1 Supported hardware

#### Controllers

This driver works with the following display controllers:

- Integrated Solutions Technology IST3088, IST3257

#### Bits per pixel

The supported color depth is 4 bpp.

#### Interfaces

The driver supports the 16-bit indirect interface.

### 13.7.4.2 Driver selection

To use GUIDRV\_IST3088 for the given display, the following command should be used:

```
pDevice = GUI_DEVICE_CreateAndLink(GUIDRV_IST3088_4, GUICC_4, 0, 0);
```

### 13.7.4.3 Display data RAM organization

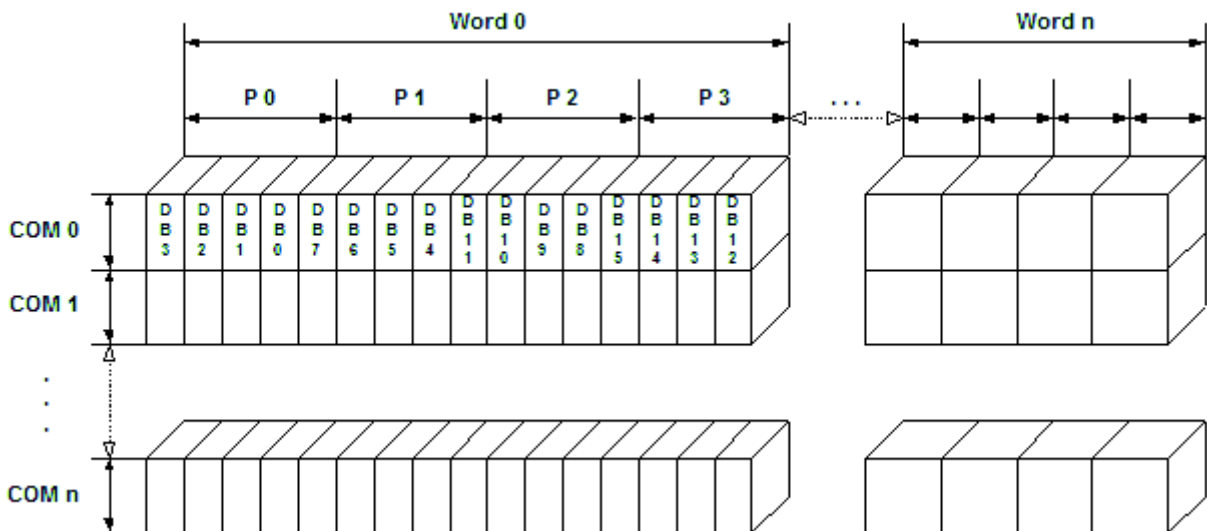

The delineation above shows the relation between the display memory and the SEG and COM lines of the LCD.

### 13.7.4.4 RAM requirements

This display driver can be used with and without a display data cache, containing a complete copy of the content of the display data RAM. The amount of memory (in bytes) used by the cache is:

```
LCD_XSIZE * LCD_YSIZE / 2.
```

### 13.7.4.5 Run-time configuration

The table below shows the available run-time configuration routines of this driver:

Routine	Description
<code>GUIDRV_IST3088_SetBus16()</code>	Tells the driver to use the 16 bit indirect interface and passes a pointer to a <code>GUI_PORT_API</code> structure to the driver containing function pointers to the hardware routines to be used.



### 13.7.4.5.1 GUIDRV\_IST3088\_SetBus16()

#### Description

Tells the driver to use the 16 bit indirect interface and passes a pointer to a GUI\_PORT\_API structure to the driver containing function pointers to the hardware routines to be used.

#### Prototype

```
void GUIDRV_IST3088_SetBus16(GUI_DEVICE * pDevice,
                             GUI_PORT_API * pHW_API);
```

#### Parameters

Parameter	Description
<a href="#">pDevice</a>	Pointer to the driver device.
<a href="#">pHW_API</a>	Pointer to a GUI_PORT_API structure. See required routines below.

### 13.7.4.6 Required GUI\_PORT\_API routines

Element	Data types
<a href="#">pfWrite16_A0</a>	void (*)(U16 Data)
<a href="#">pfWrite16_A1</a>	void (*)(U16 Data)
<a href="#">pfWriteM16_A1</a>	void (*)(U16 * pData, int NumItems)

### 13.7.4.7 Special requirements

The driver needs to work in the fixed palette mode GUICC\_4. The driver does not work with other palettes or fixed palette modes. You should use GUICC\_4 as color conversion.

## 13.7.5 GUIDRV\_Lin

This driver supports all display controllers with linear video memory accessible via direct interface. It can be used with and without a display controller. The driver does only manage the contents of the video memory. It does not send any commands to the display controller or assumes any specific registers. So it is independent of the register interface of the display controller and can be used for managing each linear mapped video memory.

### 13.7.5.1 Supported hardware

#### Controllers

The driver supports all systems with linear mapped video memory.

#### Bits per pixel

Supported color depths are 1, 2, 4, 8, 16, 24 and 32 bits per pixel.

#### Interfaces

The driver supports a full bus interface from the CPU to the video memory. The video memory needs to be accessible 8, 16 or 32 bit wise.

### 13.7.5.2 Color depth and display orientation

The driver consists of several files. They are named `_[O]_[BPP].c`. where the optional `O` stands for the desired display orientation and `BPP` for the color depth. The following table shows configuration macros which should be used for selecting the desired driver orientation during the initialization:

Identifier	Color depth and orientation
GUIDRV_LIN_1	1bpp, default orientation
GUIDRV_LIN_2	2bpp, default orientation
GUIDRV_LIN_4	4bpp, default orientation
GUIDRV_LIN_8	8bpp, default orientation
GUIDRV_LIN_OX_8	8bpp, X axis mirrored
GUIDRV_LIN_OXY_8	8bpp, X and Y axis mirrored
GUIDRV_LIN_16	16bpp, default orientation
GUIDRV_LIN_OX_16	16bpp, X axis mirrored
GUIDRV_LIN_OXY_16	16bpp, X and Y axis mirrored
GUIDRV_LIN_OY_16	16bpp, Y axis mirrored
GUIDRV_LIN_OS_16	16bpp, X and Y swapped
GUIDRV_LIN_OSX_16	16bpp, X axis mirrored, X and Y swapped
GUIDRV_LIN_OSY_16	16bpp, Y axis mirrored, X and Y swapped
GUIDRV_LIN_24	24bpp, default orientation
GUIDRV_LIN_OX_24	24bpp, X axis mirrored
GUIDRV_LIN_OXY_24	24bpp, X and Y axis mirrored
GUIDRV_LIN_OY_24	24bpp, Y axis mirrored
GUIDRV_LIN_OS_24	24bpp, X and Y swapped
GUIDRV_LIN_OSX_24	24bpp, X axis mirrored, X and Y swapped
GUIDRV_LIN_OSY_24	24bpp, Y axis mirrored, X and Y swapped
GUIDRV_LIN_32	32bpp, default orientation
GUIDRV_LIN_OX_32	32bpp, X axis mirrored

Identifier	Color depth and orientation
GUIDRV_LIN_OXY_32	32bpp, X and Y axis mirrored
GUIDRV_LIN_OY_32	32bpp, Y axis mirrored
GUIDRV_LIN_OS_32	32bpp, X and Y swapped
GUIDRV_LIN_OSX_32	32bpp, X axis mirrored, X and Y swapped
GUIDRV_LIN_OSY_32	32bpp, Y axis mirrored, X and Y swapped

The table above shows identifiers which can be used to select the driver. Each combination of orientation and color depth is possible. Please note that currently not all combinations are shipped with the driver. If the required combination is not available, please send a request to obtain the required combination.

### 13.7.5.3 Driver selection

To use for the given display, the following command can be used e.g.:

```
pDevice = GUI_DEVICE_CreateAndLink(GUIDRV_LIN_OX_16, GUICC_565, 0, 0);
```

Detailed information about palette modes can be found in the chapter *Colors* on page 604.

### 13.7.5.4 Display data RAM organization

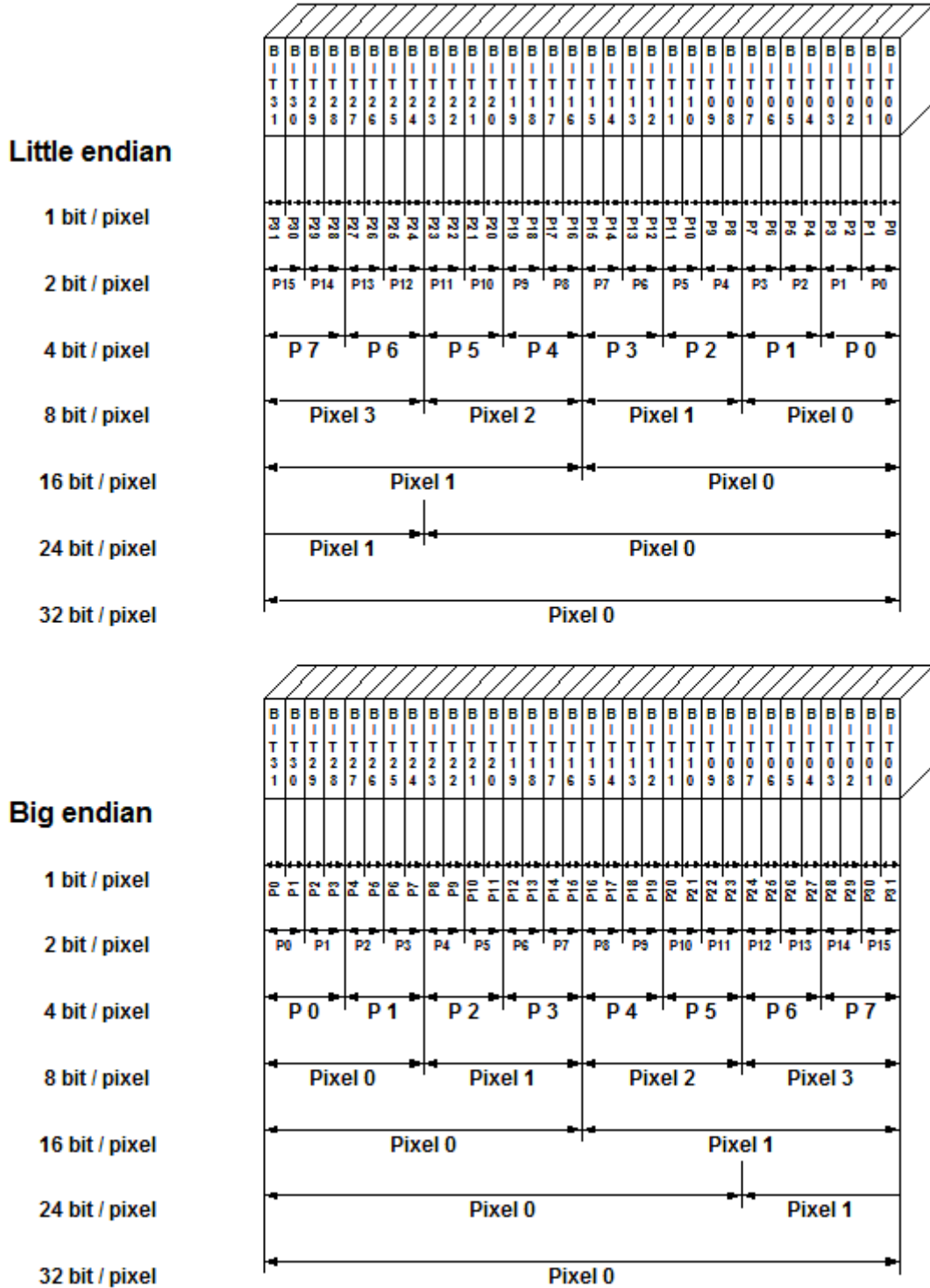

The picture above shows the relation between the display memory and the pixels of the LCD in terms of the color depth and the endian mode.

#### Little endian video mode

Least significant bits are used and output first. The least significant bits are for the first (left-most) pixel.

#### Big endian video mode

Most significant bits are used and output first. The most significant bits are for the first (left-most) pixel.

### 13.7.5.5 RAM requirements

The driver itself only requires app. 100 bytes. But the frame buffer to be managed has to exist somewhere in the RAM.

### 13.7.5.6 Compile-time configuration

The following table lists the macros which must be defined for hardware access:

Macro	Description
<code>LCD_ENDIAN_BIG</code>	Should be set to 1 for big endian mode, 0 (default) for little endian mode.

### 13.7.5.7 Run-time configuration

The following table lists the available run-time configuration routines:

Routine	Description
<code>GUIDRV_Lin_SetThreshold()</code>	This function sets a limit for using an optional hardware accelerator function for filling operations.
<code>LCD_SetDevFunc()</code>	The function sets additional and / or user defined functions of the display driver.
<code>LCD_SetSizeEx()</code>	Sets the physical size of the visible area of the given display/layer.
<code>LCD_SetVRAMAddrEx()</code>	Sets the address of the video RAM.
<code>LCD_SetVSizeEx()</code>	Sets the size of the virtual display area.

### 13.7.5.7.1 GUIDRV\_Lin\_SetThreshold()

#### Description

This function sets a limit for using an optional hardware accelerator function for filling operations.

#### Prototype

```
void GUIDRV_Lin_SetThreshold(GUI_DEVICE * pDevice,
                             int          Threshold);
```

#### Parameters

Parameter	Description
<code>pDevice</code>	Pointer to the driver device.
<code>Threshold</code>	Limit to be used for calling hardware acceleration function for filling operations.

#### Additional information

The hardware acceleration function to be used needs to be set with `LCD_SetDevFunc` on page 3455 using `LCD_DEVFUNC_FILLRECT` as function id. Setting a limit should make sure, that the acceleration function is not called for setting only a few pixels. Depending on the used hardware accelerator such a function often has more or less overhead which makes it inefficient for filling only a few pixels.

### 13.7.5.8 Commands supported by LCD\_SetDevFunc()

The following table shows the supported values of the function:

Value	Description
<code>LCD_DEVFUNC_COPYBUFFER</code>	Can be used to set a custom defined routine for copying buffers. Makes only sense in combination with multiple buffers.
<code>LCD_DEVFUNC_COPYRECT</code>	Can be used to set a custom defined routine for copying rectangular areas of the display.
<code>LCD_DEVFUNC_DRAWBMP_1BPP</code>	Can be used to set a custom routine for drawing 1bpp bitmaps.
<code>LCD_DEVFUNC_DRAWBMP_8BPP</code>	Can be used to set a custom routine for drawing 8bpp bitmaps.
<code>LCD_DEVFUNC_DRAWBMP_32BPP</code>	Can be used to set a custom routine for drawing 32bpp bitmaps.
<code>LCD_DEVFUNC_FILLRECT</code>	Can be used to set a custom defined routine for filling rectangles. Makes sense if for example a BitBLT engine should be used for filling operations.

Further information about the LCD layer routines can be found under *Display driver API* on page 3426.

### 13.7.5.9 Configuration example

The following shows how to create a display driver device with this driver and how to configure it:

```
void LCD_X_Config(void) {
    //
    // Set display driver and color conversion
    //
    GUI_DEVICE_CreateAndLink(GUIDRV_LIN_8, // Display driver
```

```
        GUICC_8666,      // Color conversion
        0, 0);
//
// Display driver configuration
//
LCD_SetSizeEx    (0, 320, 240);      // Physical display size in pixels
LCD_SetVSizeEx  (0, 320, 480);     // Virtual display size in pixels
LCD_SetVRAMAddrEx(0, (void *)0x20000000); // Video RAM start address
}
```

### 13.7.5.10 Using the Lin driver in systems with cache memory

The rules to follow are quite simple:

#### Rule 1

All caches (if applicable, as in your case) should be fully enabled. This means I- and D-caches in systems with separate caches.

#### Rule 2

All code and data should be placed in cacheable areas to achieve maximum performance. If other parts of the application require some or all data to be placed in non-cacheable areas, this is not a problem but may degrade performance.

#### Rule 3

The cache settings for the frame buffer memory (which is really a shared memory area, accessed by both the CPU and the LCD-controller DMA) should make sure, that write operations are 'write-through' operations. The physical memory should be always up to date, so that the DMA-access of the LCD-controller always get the current content of the frame buffer. In case of a 'write-back' cache a write operation only changes the content of the cache, which is written to the physical memory not before the cache location is superseded. In many systems with MMU, this can be achieved by mapping the RAM twice into the virtual address space: At its normal address, the RAM is cacheable and bufferable, at the second address, it is cacheable but not bufferable. The address of the VRAM given to the driver should be the non bufferable address.

#### 'write-through' cache not available

If the CPU does not support a 'write-through' cache please refer to chapter *Framebuffer located in data cache area of CPU* on page 146. It explains how multiple buffering and a cache clearance function can be used.

## 13.7.6 GUIDRV\_S1D13C00

This driver has been developed for the Epson S1D13C00 display controller.

### 13.7.6.1 Supported hardware

#### Controllers

This driver supports the Epson S1D13C00 only.

#### Bits per pixel

The driver supports two color depths, 6 bit per pixel + 2 bit alpha and 1 bit per pixel.

Each channel of the 6 bit per pixel + 2 bit alpha color format is represented by 2 bits (ARGB) where an alpha channel with both bits set is opaque.

Currently the only supported color conversions are `GUICC_M2222I` and `GUICC_1`.

If other color depths/formats (supported by the controller) are required just let us know.

#### Interface

The only interface routine required for this driver is a function to send 8bit data to the controller.

#### Note

The first four bytes send in the data stream containing a VRAM address into the S1D13C00s VRAM.

### 13.7.6.2 Display orientation

The driver supports several orientations which can be selected by choosing the correct driver during in

Identifier	Orientation
<code>GUIDRV_S1D13C00_1_0</code>	1 bpp Default orientation
<code>GUIDRV_S1D13C00_1_OX</code>	1 bpp X axis mirrored
<code>GUIDRV_S1D13C00_1_OY</code>	1 bpp Y axis mirrored
<code>GUIDRV_S1D13C00_1_OXY</code>	1 bpp X and Y axis mirrored (rotated 180°)
<code>GUIDRV_S1D13C00_1_OS</code>	1 bpp X and Y swapped
<code>GUIDRV_S1D13C00_1_OSX</code>	1 bpp X and Y swapped, X axis mirrored (rotated 90° CW)
<code>GUIDRV_S1D13C00_1_OSY</code>	1 bpp X and Y swapped, Y axis mirrored (rotated 90° CCW)
<code>GUIDRV_S1D13C00_1_OSXY</code>	1 bpp X and Y swapped, X and Y axis mirrored
<code>GUIDRV_S1D13C00_6_0</code>	6 bpp Default orientation
<code>GUIDRV_S1D13C00_6_OX</code>	6 bpp X axis mirrored
<code>GUIDRV_S1D13C00_6_OY</code>	6 bpp Y axis mirrored
<code>GUIDRV_S1D13C00_6_OXY</code>	6 bpp X and Y axis mirrored (rotated 180°)
<code>GUIDRV_S1D13C00_6_OS</code>	6 bpp X and Y swapped
<code>GUIDRV_S1D13C00_6_OSX</code>	6 bpp X and Y swapped, X axis mirrored (rotated 90° CW)
<code>GUIDRV_S1D13C00_6_OSY</code>	6 bpp X and Y swapped, Y axis mirrored (rotated 90° CCW)



Identifier	Orientation
GUIDRV_S1D13C00_6_OSXY	6 bpp X and Y swapped, X and Y axis mirrored

### 13.7.6.3 Driver selection

To use GUIDRV\_S1D13C00 for a 6 + 2 bpp configuration the following command can be used:

```
pDevice = GUI_DEVICE_CreateAndLink(GUIDRV_S1D13C00_6_0, GUICC_M2222I, 0, 0);
```

To use GUIDRV\_S1D13C00 for a 1 bpp configuration the following command can be used:

```
pDevice = GUI_DEVICE_CreateAndLink(GUIDRV_S1D13C00_1_0, GUICC_1, 0, 0);
```

### 13.7.6.4 Display data RAM organization 1bpp

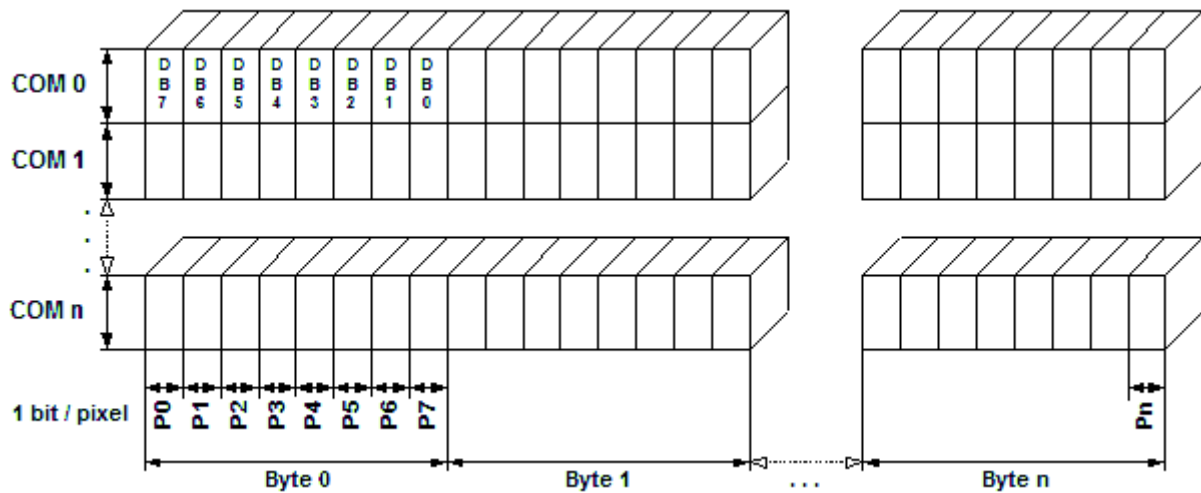

The picture above shows the relation between the display memory and the SEG and COM lines of the display.

### 13.7.6.5 Display data RAM organization 6 + 2bpp

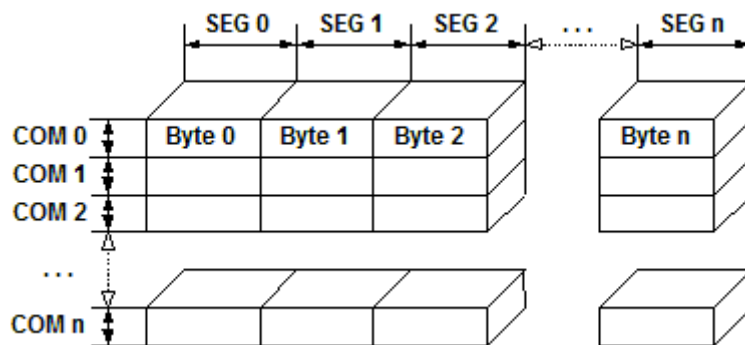

The picture above shows the relation between the display memory and the SEG and COM lines of the display.

### 13.7.6.6 RAM requirements

This driver always uses a cache to mirroring the pixel data shown on the display. This cache improves the performance and makes reading from the display controller unnecessary.

The required size of the display cache can be calculated as follows:

$$\text{Size} = (\text{BitsPerPixel} * (\text{LCD\_XSIZE} + 7) / 8) * \text{LCD\_YSIZE}$$

**Note**

If not using the the Window Manager use `LCD_ControlCache()` to lock and unlock the cache before and after drawing operations.

### 13.7.6.7 Run-time configuration

The table below shows the available run-time configuration routines of this driver:

Routine	Description
<code>GUIDRV_S1D13C00_Config()</code>	This function sets a <code>config</code> structure.
<code>GUIDRV_S1D13C00_SetBaseAddress()</code>	This function sets the base address of the S1D13C00 VRAM.
<code>GUIDRV_S1D13C00_SetBus()</code>	This function sets the hardware interface routines.

### 13.7.6.7.1 GUIDRV\_S1D13C00\_Config()

#### Description

This function sets a `config` structure.

#### Prototype

```
void GUIDRV_S1D13C00_Config(GUI_DEVICE      * pDevice,  
                             CONFIG_S1D13C00 * pConfig);
```

#### Parameters

Parameter	Description
<code>pDevice</code>	Pointer to the driver device.
<code>pConfig</code>	Pointer to a <code>CONFIG_S1D13C00</code> structure

#### Additional information

It is mandatory to set a update function which triggers an update on the S1D13C00 controller. Without this function the driver won't work.

### 13.7.6.7.2 GUIDRV\_S1D13C00\_SetBaseAddress()

#### Description

This function sets the base address of the S1D13C00 VRAM. Typically this is 0x20000000.

#### Prototype

```
void GUIDRV_S1D13C00_SetBaseAddress(GUI_DEVICE * pDevice,  
                                     U32      BaseAddr);
```

#### Parameters

Parameter	Description
<a href="#">pDevice</a>	Pointer to the driver device.
<a href="#">BaseAddr</a>	VRAM Base address.

#### Additional information

Typically the base address is 0x20000000 and doesn't need to be changed.

### 13.7.6.7.3 GUIDRV\_S1D13C00\_SetBus()

#### Description

This function sets the hardware interface routines.

#### Prototype

```
void GUIDRV_S1D13C00_SetBus(GUI_DEVICE * pDevice,
                            GUI_PORT_API * pPortAPI);
```

#### Parameters

Parameter	Description
<code>pDevice</code>	Pointer to the driver device.
<code>pPortAPI</code>	Port API structure

#### Additional information

Only `pPortAPI->pfWriteM8_A1()` is used.

#### Required GUI\_PORT\_API routines

Data type	Element	Description
<code>void (*)(U8 * pData, int NumItems)</code>	<code>pfWriteM8_A1</code>	Pointer to a function which writes multiple bytes to the data register.

This is an example showing how receive the VRAM address from the data stream and use it to write to the S1D13C00s VRAM:

```

/*****
 *
 *     _WriteM8_A1
 */
static void _WriteM8_A1(U8 * pData, int NumBytes) {
    U32 Addr;

    Addr = 0;
    Addr |= *pData++;
    Addr |= *pData++ << 8;
    Addr |= *pData++ << 16;
    Addr |= *pData++ << 24;
    seS1D13C00Write(Addr, pData, NumBytes);
}

```

## 13.7.7 GUIDRV\_S1D13L04

## 13.7.8 GUIDRV\_S1D13513

### Note

From a technical point of view both drivers are identically.

- <DRV> = 'L04': GUIDRV\_S1D13L04
- <DRV> = '513': GUIDRV\_S1D13513

### 13.7.8.1 Supported hardware

#### Controllers

This driver supports the Epson S1D13<DRV> only.

#### Bits per pixel

The supported color depth is 24 (Main and PIP1 layer) and 32 bpp (PIP2 layer).

#### Interfaces

The driver supports the 16-bit indirect interface only.

### 13.7.8.2 Driver selection

To use GUIDRV\_S1D13<DRV> the following command should be used:

```
pDevice = GUI_DEVICE_CreateAndLink(GUIDRV_S1D13<DRV>_32, GUICC_M888, 0, 0);
```

The `Sample` folder contains a configuration sample which shows in detail how to configure the driver.

### 13.7.8.3 Display data RAM organization

#### 24 bits per pixel, fixed palette = M888 (MAIN and PIP1)

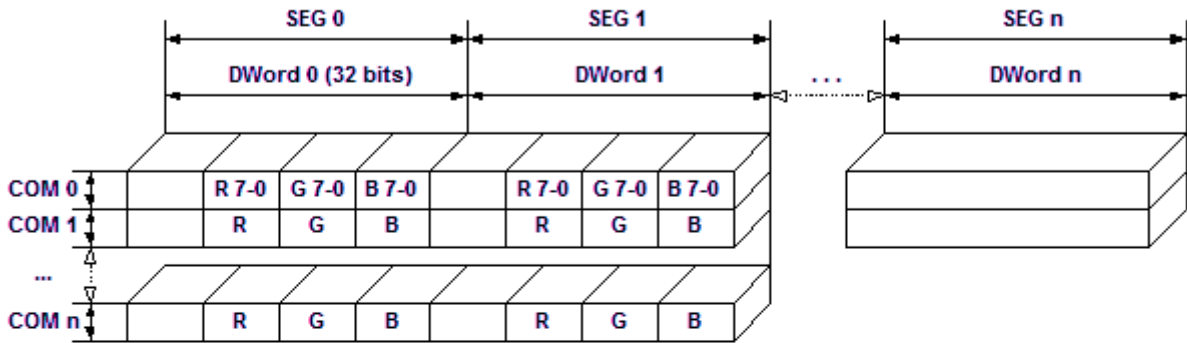

#### 32 bits per pixel, fixed palette = M8888I (PIP2)

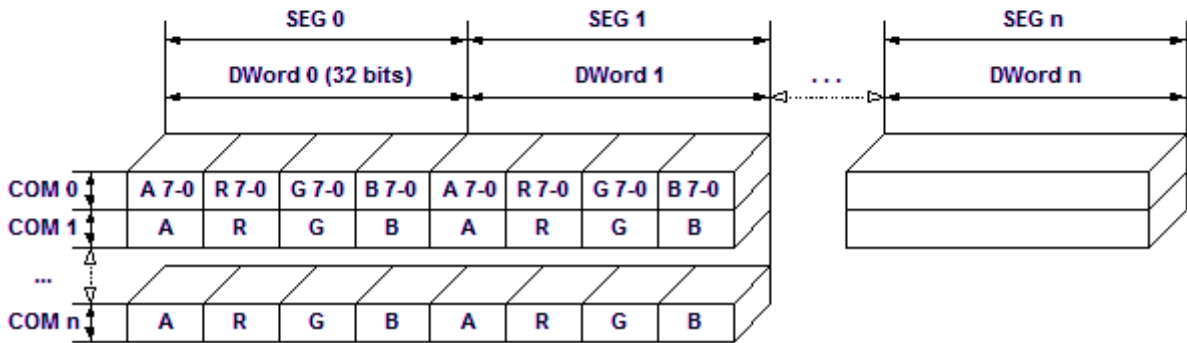

Relationship between memory and the SEG and COM lines.

### 13.7.8.4 RAM requirements

Approximately 2 KB.

### 13.7.8.5 Basic function

The driver uses the indirect interface mode of the S1D13<DRV>. It uses 3 registers for accessing the controller:

- Index register, tells the controller which SFR should be accessed.
- Status register, used to get the busy status of the controller.
- Data register for writing/reading data to/from SFRs/frame buffer.

### 13.7.8.6 Run-time configuration

The table below shows the available run-time configuration routines of this driver:

Routine	Description
<code>GUIDRV_S1D13L04_Config()</code> <code>GUIDRV_S1D13513_Config()</code>	Passes a pointer to a <code>CONFIG_S1D13&lt;DRV&gt;</code> structure to the driver.
<code>GUIDRV_S1D13L04_SetBus16()</code> <code>GUIDRV_S1D13513_SetBus16()</code>	Configures the driver to use the 16 bit indirect interface by passing a pointer to a <code>GUI_PORT_API</code> structure.

**13.7.8.6.1 GUIDRV\_S1D13L04\_Config()****13.7.8.6.2 GUIDRV\_S1D13513\_Config()****Description**

Configures the driver to work according to the passed CONFIG\_S1D13<DRV> structure.

**Prototype**

```
void GUIDRV_S1D13<DRV>_Config(GUI_DEVICE      * pDevice,
                             CONFIG_S1D13<DRV> * pConfig);
```

**Parameters**

Parameter	Description
<a href="#">pDevice</a>	Pointer to the driver device.
<a href="#">pConfig</a>	Pointer to a CONFIG_S1D13<DRV> structure described below.

**Elements of structure CONFIG\_S1D13<DRV>**

Data type	Element	Description
U32	BufferOffset	This offset added to the VideoRAM start address, results in the start address used for the selected PIP layer.
int	UseLayer	(see table below)

Permitted values for <a href="#">UseLayer</a>	
GUIDRV_S1D13<DRV>_USE_PIP1	PIP1 should be used
GUIDRV_S1D13<DRV>_USE_PIP2	PIP2 should be used



### 13.7.8.6.3 GUIDRV\_S1D13L04\_SetBus16()

### 13.7.8.6.4 GUIDRV\_S1D13513\_SetBus16()

#### Description

Tells the driver to use the 16 bit indirect interface and passes a pointer to a GUI\_PORT\_API structure to the driver containing function pointers to the hardware routines to be used.

#### Prototype

```
void GUIDRV_S1D13513_SetBus16(GUI_DEVICE * pDevice,
                             GUI_PORT_API * pHW_API);
```

#### Parameters

Parameter	Description
<code>pDevice</code>	Pointer to the driver device.
<code>pHW_API</code>	Pointer to a GUI_PORT_API structure. See required routines below.

#### Required GUI\_PORT\_API routines

Data type	Element	Description
<code>void (*)(U16 Data)</code>	<code>pfWrite16_A0</code>	Pointer to a function which writes one word to the index register.
<code>void (*)(U16 Data)</code>	<code>pfWrite16_A1</code>	Pointer to a function which writes one word to the data register.
<code>void (*)(U16 * pData, int NumItems)</code>	<code>pfWriteM16_A1</code>	Pointer to a function which writes multiple words to the data register.
<code>U16 (*)(void)</code>	<code>pfRead16_A0</code>	Pointer to a function which reads one word from the index register.
<code>U16 (*)(void)</code>	<code>pfRead16_A1</code>	Pointer to a function which reads one word from the data register.
<code>void (*)(U16 * pData, int NumItems)</code>	<code>pfReadM16_A1</code>	Pointer to a function which reads multiple words from the data register.
<code>void (*)(void)</code>	<code>pfFlushBuffer</code>	Pointer to a function which waits until the busy flag of the status register is cleared (0).

#### Special requirements

The driver needs to work with the fixed palette modes explained above. It further requires a function which waits until the busy flag of the status register is cleared.

## 13.7.9 GUIDRV\_S1D13L02

## 13.7.10 GUIDRV\_S1D13748

### Note

From a technical point of view both drivers are identically.

- <DRV> = 'L02': GUIDRV\_S1D13L02
- <DRV> = '748': GUIDRV\_S1D13748

### 13.7.10.1 Supported hardware

#### Controllers

This driver has been tested with the Epson S1D13<DRV>.

#### Bits per pixel

The supported color depth is 16 bpp.

#### Interfaces

The driver supports the 16-bit indirect interface.

### 13.7.10.2 Basic function

The driver currently supports indirect mode only. Only 2 registers, namely register 0 and 2 are used.

#### Hardware interface

AB[1] = GND  
 AB[2] = Used as Address pin  
 AB[3] = GND

AB[3:0]	Register
000	Index
001	Status
010	Data
011	Reserved
100	GPIO Status
101	GPIO Config
110	GPIO Input Enable
111	GPIO Pull-down Control

#### Reset

The RESET pin should be connected to the system reset. The RESET pin of the Microcontroller / CPU is usually called NRESET.

### 13.7.10.3 Driver selection

To use GUIDRV\_S1D13<DRV> for the given display, the following command should be used:

```
pDevice = GUI_DEVICE_CreateAndLink(GUIDRV_S1D13<DRV>, GUICC_M565, 0, 0);
```

### 13.7.10.4 Display data RAM organization

**16 bits per pixel, fixed palette = 565**

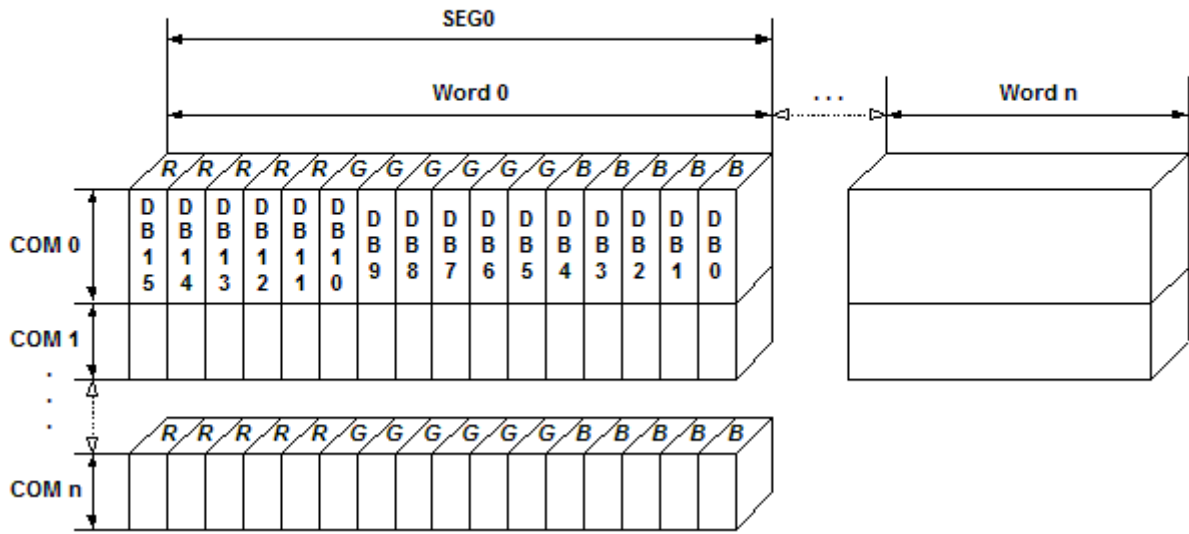

Relationship between memory and the SEG and COM lines.

### 13.7.10.5 RAM requirements

Approximately 500 bytes.

### 13.7.10.6 Run-time configuration

The table below shows the available run-time configuration routines of this driver:

Routine	Description
<a href="#">GUIDRV_S1D13L02_Config()</a> <a href="#">GUIDRV_S1D13748_Config()</a>	Passes a pointer to a <code>CONFIG_S1D13&lt;DRV&gt;</code> structure to the driver.
<a href="#">GUIDRV_S1D13L02_SetBus16()</a> <a href="#">GUIDRV_S1D13748_SetBus16()</a>	Configures the driver to use the 16 bit indirect interface by passing a pointer to a <code>GUI_PORT_API</code> structure.

**13.7.10.6.1 GUIDRV\_S1D13L02\_Config()****13.7.10.6.2 GUIDRV\_S1D13748\_Config()****Description**

Configures the driver to work according to the passed CONFIG\_S1D13<DRV> structure.

**Prototype**

```
void GUIDRV_S1D13<DRV>_Config(GUI_DEVICE      * pDevice,
                             CONFIG_S1D13<DRV> * pConfig);
```

**Parameters**

Parameter	Description
<a href="#">pDevice</a>	Pointer to the driver device.
<a href="#">pConfig</a>	Pointer to a CONFIG_S1D13<DRV> structure described below.

**Elements of structure CONFIG\_S1D13<DRV>**

Data type	Element	Description
U32	BufferOffset	This offset added to the VideoRAM start address, results in the start address used for the selected PIP layer.
int	UseLayer	PIP layer to be used.

### 13.7.10.6.3 GUIDRV\_S1D13L02\_SetBus16()

### 13.7.10.6.4 GUIDRV\_S1D13748\_SetBus16()

#### Description

Tells the driver to use the 16 bit indirect interface and passes a pointer to a GUI\_PORT\_API structure to the driver containing function pointers to the hardware routines to be used.

#### Prototype

```
void GUIDRV_S1D13748_SetBus16(GUI_DEVICE * pDevice,
                             GUI_PORT_API * pHW_API);
```

#### Parameters

Parameter	Description
<code>pDevice</code>	Pointer to the driver device.
<code>pHW_API</code>	Pointer to a GUI_PORT_API structure. See required routines below.

### 13.7.10.7 Required GUI\_PORT\_API routines

Data type	Element	Description
<code>void (*)(U16 Data)</code>	<code>pfWrite16_A0</code>	Pointer to a function which writes one word to the controller with C/D line low.
<code>void (*)(U16 Data)</code>	<code>pfWrite16_A1</code>	Pointer to a function which writes one word to the controller with C/D line high.
<code>void (*)(U16 * pData, int NumItems)</code>	<code>pfWriteM16_A1</code>	Pointer to a function which writes multiple words to the controller with C/D line high.
<code>U16 (*)(void)</code>	<code>pfRead16_A1</code>	Pointer to a function which reads one word from the controller with C/D line high.
<code>void (*)(U16 * pData, int NumItems)</code>	<code>pfReadM16_A1</code>	Pointer to a function which reads multiple words from the controller with C/D line high.

### 13.7.10.8 Special requirements

The driver needs to work with the fixed palette mode `GUICC_M565`. The driver does not work with other palettes or fixed palette modes.

## 13.7.11 GUIDRV\_S1D13L01

## 13.7.12 GUIDRV\_S1D13781

### Note

From a technical point of view both drivers are identically.

- <DRV> = 'L01': GUIDRV\_S1D13L01
- <DRV> = '781': GUIDRV\_S1D13781

### 13.7.12.1 Supported hardware

#### Controllers

This driver has been tested with the Epson S1D13<DRV>.

#### Bits per pixel

Currently the supported color depth is 8 and 16 bpp. This can be enhanced on demand.

#### Interfaces

Currently the driver supports only the 8-bit indirect serial host interface. Can be enhanced on demand.

### 13.7.12.2 Display orientation

The driver can be used with different orientations. The following table shows the configuration macros which can be used to create and link the driver during the initialization:

Identifier	Color depth and orientation
GUIDRV_S1D13<DRV>_8C0	8bpp, default orientation
GUIDRV_S1D13<DRV>_OXY_8C0	8bpp, X and Y axis mirrored
GUIDRV_S1D13<DRV>_OSY_8C0	8bpp, X axis mirrored, X and Y swapped
GUIDRV_S1D13<DRV>_OSX_8C0	8bpp, Y axis mirrored, X and Y swapped
GUIDRV_S1D13<DRV>_16C0	16bpp, default orientation
GUIDRV_S1D13<DRV>_OXY_16C0	16bpp, X and Y axis mirrored
GUIDRV_S1D13<DRV>_OSY_16C0	16bpp, X axis mirrored, X and Y swapped
GUIDRV_S1D13<DRV>_OSX_16C0	16bpp, Y axis mirrored, X and Y swapped

The table above shows identifiers which can be used to select the driver.

### 13.7.12.3 Driver selection

To use GUIDRV\_S1D13<DRV> for the given display, the following command should be used for the 8bpp version:

```
pDevice = GUI_DEVICE_CreateAndLink(GUIDRV_S1D13<DRV>_8C0, GUICC_8666, 0, 0);
```

To use the 16bpp version use the following command:

```
pDevice = GUI_DEVICE_CreateAndLink(GUIDRV_S1D13<DRV>_16C0, GUICC_M565, 0, 0);
```

### 13.7.12.4 Display data RAM organization

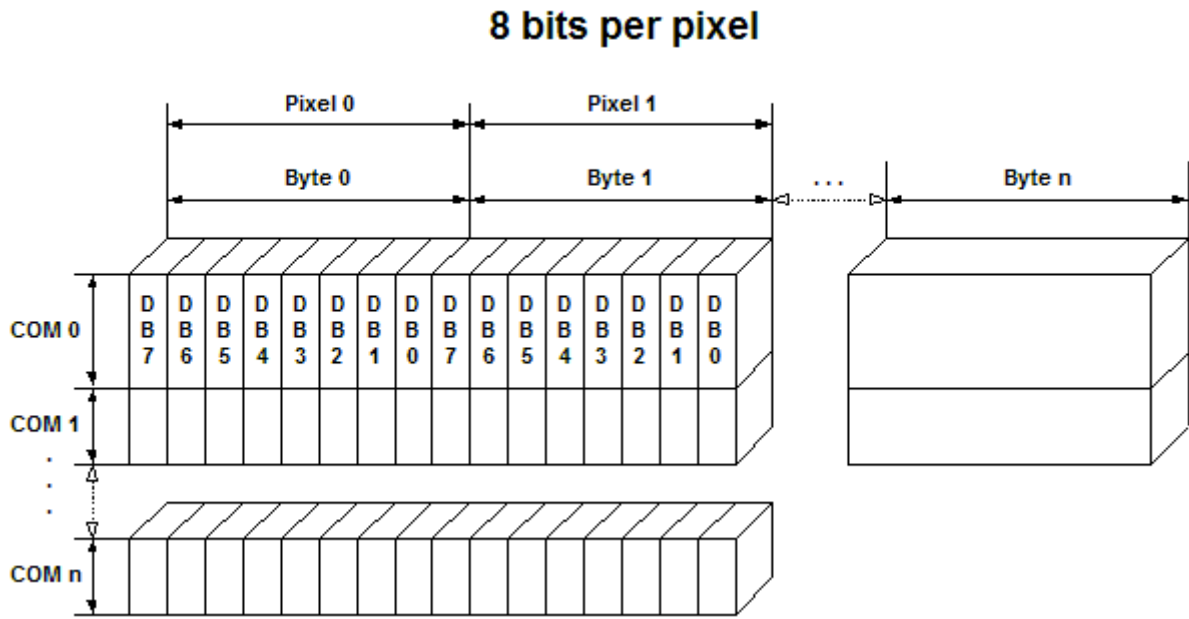

Relationship between memory and the SEG and COM lines for 8bpp mode.

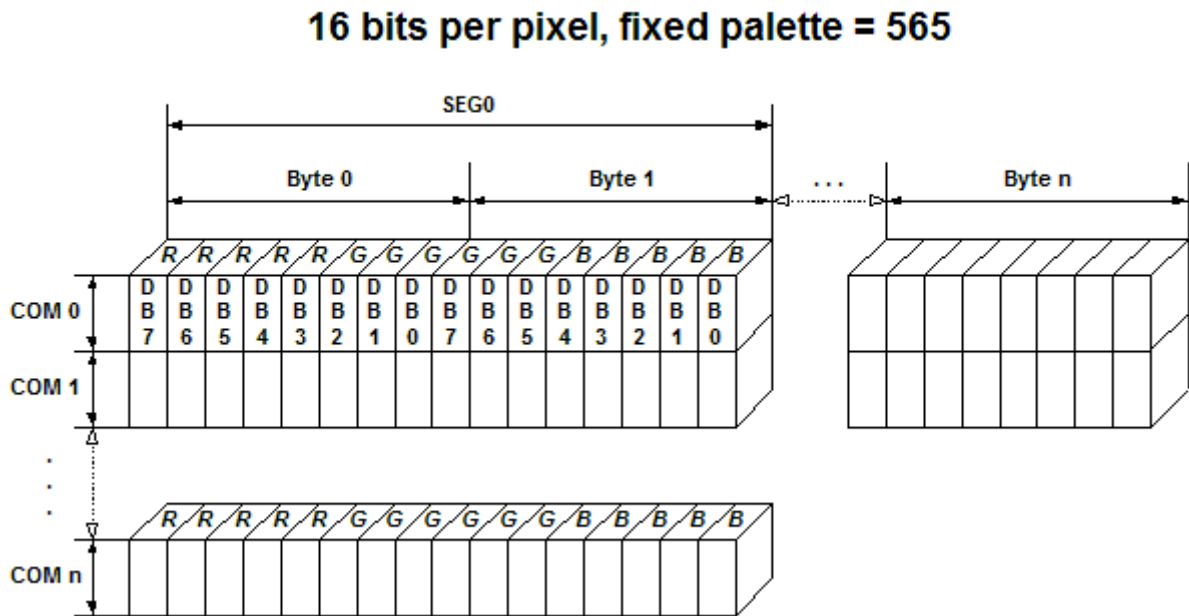

Relationship between memory and the SEG and COM lines for 16bpp mode.

### 13.7.12.5 RAM requirements

Approximately 1 KB.

### 13.7.12.6 Run-time configuration

The table below shows the available run-time configuration routines of this driver:

Routine	Description
<code>GUIDRV_S1D13L01_Config()</code> <code>GUIDRV_S1D13781_Config()</code>	Passes a pointer to a <code>CONFIG_S1D13&lt;DRV&gt;</code> structure to the driver.

Routine	Description
<code>GUIDRV_S1D13L01_SetBusSPI()</code> <code>GUIDRV_S1D13781_SetBusSPI()</code>	Configures the driver to use the 8 bit indirect serial host interface by passing a pointer to a <code>GUI_PORT_API</code> structure.
<code>GUIDRV_S1D13L01_SetOrientation()</code> <code>GUIDRV_S1D13781_SetOrientation()</code>	Sets a new orientation for the given layer.



**13.7.12.6.1 GUIDRV\_S1D13L01\_Config()****13.7.12.6.2 GUIDRV\_S1D13781\_Config()****Description**

Configures the driver to work according to the passed CONFIG\_S1D13<DRV> structure.

**Prototype**

```
void GUIDRV_S1D13<DRV>_Config(GUI_DEVICE      * pDevice,
                             CONFIG_S1D13<DRV> * pConfig);
```

**Parameters**

Parameter	Description
<a href="#">pDevice</a>	Pointer to the driver device.
<a href="#">pConfig</a>	Pointer to a CONFIG_S1D13<DRV> structure described below.

**Elements of structure CONFIG\_S1D13<DRV>**

Data type	Element	Description
U32	BufferOffset	This offset added to the VideoRAM start address, results in the start address used for the selected PIP layer.
int	WriteBufferSize	Number of bytes used for the write buffer. The buffer should be large enough to be able to store at least one line of data + 5 bytes. Because the layer size can be changed dynamically, it is required to set up the buffer size during the configuration. The default value of the buffer size is 500 bytes.
int	UseLayer	Should be 1 if PIP layer should be used.
int	WaitUntilVNDP	Used for Multiple Buffering configurations only. If set to 1 the driver waits until the next vertical non display period has been reached. This can be used to reduce flickering effects with fast animations.

### 13.7.12.6.3 GUIDRV\_S1D13L01\_SetBusSPI()

### 13.7.12.6.4 GUIDRV\_S1D13781\_SetBusSPI()

#### Description

Tells the driver to use the 8 bit indirect serial host interface and passes a pointer to a `GUI_PORT_API` structure to the driver containing function pointers to the hardware routines to be used.

#### Prototype

```
void GUIDRV_S1D13781_SetBusSPI(GUI_DEVICE * pDevice,  
                               GUI_PORT_API * pHW_API);
```

#### Parameters

Parameter	Description
<code>pDevice</code>	Pointer to the driver device.
<code>pHW_API</code>	Pointer to a <code>GUI_PORT_API</code> structure. See required routines below.

### 13.7.12.6.5 GUIDRV\_S1D13L01\_SetOrientation()

### 13.7.12.6.6 GUIDRV\_S1D13781\_SetOrientation()

#### Description

This function set the given orientation for the given layer.

#### Prototype

```
int GUIDRV_S1D13781_SetOrientation(int Orientation,
                                   int LayerIndex);
```

#### Parameters

Parameter	Description
<a href="#">Orientation</a>	The orientation to be used.
<a href="#">LayerIndex</a>	Index of the layer the orientation should be set for.

#### Return value

0        on success  
1        on error.

### 13.7.12.7 Required GUI\_PORT\_API routines

Data type	Element	Description
void (*)(U8 Data)	<a href="#">pfWrite8_A0</a>	Pointer to a function which writes one byte to the controller with C/D line low.
void (*)(U8 Data)	<a href="#">pfWrite8_A1</a>	Pointer to a function which writes one byte to the controller with C/D line high.
void (*)(U8 * pData, int NumItems)	<a href="#">pfWriteM8_A1</a>	Pointer to a function which writes multiple bytes to the controller with C/D line high.
U8 (*)(void)	<a href="#">pfRead8_A1</a>	Pointer to a function which reads one byte from the controller with C/D line high.
void (*)(U8 * pData, int NumItems)	<a href="#">pfReadM8_A1</a>	Pointer to a function which reads multiple bytes from the controller with C/D line high.
void (*)(U8 NotActive)	<a href="#">pfSetCS</a>	Routine which is able to toggle the CS signal of the controller: NotActive = 1 means CS = high NotActive = 0 means CS = low

### 13.7.12.8 Optional functions

The following table shows the optional LCD-functions which are available with this driver:

Routine	Description
<a href="#">GUI_GetLayerPosEx()</a>	Returns the X- and Y-position of the given layer.
<a href="#">GUI_SetLayerPosEx()</a>	Sets the X- and Y-position of the given layer.
<a href="#">GUI_SetLayerSizeEx()</a>	Sets the X- and Y-size of the given layer.
<a href="#">GUI_SetLayerVisEx()</a>	Sets the visibility of the given layer.
<a href="#">LCD_SetAlphaEx()</a>	Sets the layer alpha value of the given layer.

Routine	Description
<a href="#">LCD_SetChromaEx()</a>	Sets the colors to be used for the chroma mode.
<a href="#">LCD_SetChromaModeEx()</a>	Enables the chroma mode of the given layer.

More details about the optional functions can be found in *MultiLayer API* on page 3238.

### 13.7.12.9 Additional information

The display driver automatically initializes the following registers:

Register	Description
0x60824	X-size of main layer.
0x60828	Y-size of main layer.
0x60840	Main layer settings.

This means the above registers do not need to be initialized by the applications initialization code for the display controller.

### 13.7.13 GUIDRV\_S1D15G00

#### 13.7.13.1 Supported hardware

##### Controllers

The driver supports the Epson S1D15G00 controller.

##### Bits per pixel

Supported color depth is 12bpp.

##### Interfaces

The driver supports the 8 bit indirect interface.

#### 13.7.13.2 Driver selection

To use GUIDRV\_S1D15G00 for the given display, the following command should be used:

```
pDevice = GUI_DEVICE_CreateAndLink(GUIDRV_S1D15G00, GUICC_M444_12, 0, 0);
```

#### 13.7.13.3 Display data RAM organization

##### 12 bits per pixel, fixed palette = M444\_12

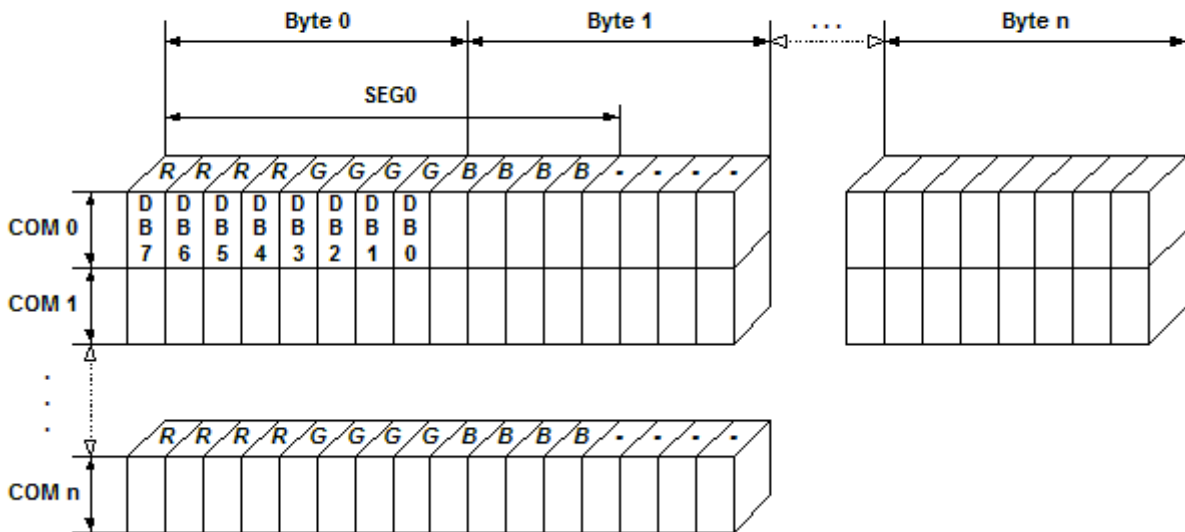

The picture above shows the relation between the display memory and the SEG and COM lines of the LCD.

#### 13.7.13.4 RAM requirements

This display driver can be used with and without a display data cache, containing a complete copy of the contents of the LCD data RAM. The amount of memory used by the cache is:

```
LCD_XSIZE * LCD_YSIZE * 2 bytes
```

Using a cache is recommended only if a lot of drawing operations uses the XOR drawing mode. A cache would avoid reading the display data in this case. Normally the use of a cache is not recommended.

### 13.7.13.5 Run-time configuration

The table below shows the available run-time configuration routines of this driver:

Routine	Description
<code>GUIDRV_S1D15G00_Config()</code>	Passes a pointer to a <code>CONFIG_S1D15G00</code> structure to the driver.
<code>GUIDRV_S1D15G00_SetBus8()</code>	Tells the driver to use the 8 bit indirect interface and passes a pointer to a <code>GUI_PORT_API</code> structure to the driver containing function pointers to the hardware routines to be used.

### 13.7.13.5.1 GUIDRV\_S1D15G00\_Config()

#### Description

Passes a pointer to a CONFIG\_S1D15G00 structure to the driver.

#### Prototype

```
void GUIDRV_S1D15G00_Config(GUI_DEVICE      * pDevice,
                           CONFIG_S1D15G00 * pConfig);
```

#### Parameters

Parameter	Description
<code>pDevice</code>	Pointer to the driver device.
<code>pConfig</code>	Pointer to a CONFIG_S1D15G00 structure described below.

#### Elements of structure CONFIG\_S1D15G00

Data type	Element	Description
int	FirstSEG	First segment address to be used in the data RAM of the display controller. The value can be determined experimentally or taken from the display documentation. The value is normally 0.
int	FirstCOM	First common address to be used in the data RAM of the display controller. The value can be determined experimentally or taken from the display documentation. The value is normally 0.
int	UseCache	Enables or disables use of a data cache. Should be set to 1 for enabling and to 0 for disabling.

### 13.7.13.5.2 GUIDRV\_S1D15G00\_SetBus8()

#### Description

Tells the driver to use the 8 bit indirect interface and passes a pointer to a GUI\_PORT\_API structure to the driver containing function pointers to the hardware routines to be used.

#### Prototype

```
void GUIDRV_S1D15G00_SetBus8(GUI_DEVICE * pDevice,
                             GUI_PORT_API * pHW_API);
```

#### Parameters

Parameter	Description
<code>pDevice</code>	Pointer to the driver device.
<code>pHW_API</code>	Pointer to a GUI_PORT_API structure. See required routines below.

### 13.7.13.6 Required GUI\_PORT\_API routines

Data type	Element	Description
<code>void (*)(U8 Data)</code>	<code>pfWrite8_A0</code>	Pointer to a function which writes one byte to the controller with C/D line low.
<code>void (*)(U8 Data)</code>	<code>pfWrite8_A1</code>	Pointer to a function which writes one byte to the controller with C/D line high.
<code>void (*)(U8 * pData, int NumItems)</code>	<code>pfWriteM8_A1</code>	Pointer to a function which writes multiple bytes to the controller with C/D line high.
<code>U8 (*)(void)</code>	<code>pfRead8_A1</code>	Pointer to a function which reads one byte from the controller with C/D line high.

### 13.7.13.7 Configuration example

```
#define XSIZE 130
#define YSIZE 130
GUI_PORT_API _PortAPI;
void LCD_X_Config(void) {
    GUI_DEVICE * pDevice;
    CONFIG_S1D15G00 Config = {0};
    //
    // Set display driver and color conversion for 1st layer
    //
    pDevice = GUI_DEVICE_CreateAndLink(GUIDRV_S1D15G00, GUICC_M444_12, 0, 0);
    //
    // Display driver configuration
    //
    LCD_SetSizeEx (0, XSIZE, YSIZE);
    LCD_SetVSizeEx(0, XSIZE, YSIZE);
    //
    // Driver specific configuration
    //
    Config.FirstCOM = 2;
    GUIDRV_S1D15G00_Config(pDevice, &Config);
    //
    // Setup hardware access routines
    //
    _PortAPI.pfWrite8_A0 = _Write_A0;
    _PortAPI.pfWrite8_A1 = _Write_A1;
    _PortAPI.pfWriteM8_A1 = _WriteM_A1;
    GUIDRV_S1D15G00_SetBus8(pDevice, &PortAPI);
}
```



## 13.7.14 GUIDRV\_SH\_MEM

The driver supports Sharp Memory LCDs. Those kind of displays do not support reading back the display content. Further this LCDs do not support writing single pixels. The smallest unit for a writing operation is one complete line of pixels. Because of that a cache is required in the driver. To achieve the best possible performance it is recommended to lock and unlock the cache before/after large drawing operations.

### VCOM signal

Sharp Memory LCDs require a VCOM signal which should be toggled with a frequency of approx. 500-1000ms. That could be achieved per hardware (EXTMODE=H) or per software (EXTMODE=L). EXTMODE is the configuration pin of the LCD.

### EXTMODE = H

There are 2 possible ways to achieve toggling the EXTCOMIN signal. One solution is toggling the signal by a timer interrupt or a similar routine which is called with the required frequency. The second solution is using the function `GUIDRV_SH_MEM_Config()` explained later and uses a custom function called periodically by the driver.

### EXTMODE = L

In that case the driver uses the software interface of the Sharp Memory LCD to toggle the V-bit. The function `GUIDRV_SH_MEM_Config()` should be used to set the desired period.

### 13.7.14.1 Supported hardware

#### Displays

Sharp Memory LCDs (b/w and 3bpp) with 8- or 10 bit address interface and compatible displays.

#### Bits per pixel

Supported color depth is 1 and 3bpp.

#### Interfaces

The driver supports the indirect serial interface required for using that kind of LCDs.

### 13.7.14.2 Display orientation

The driver consists of several files. They are named `_[O].c` where the optional `O` stands for the desired display orientation. The following table shows the configuration macros which should be used to select the desired display orientation during the initialization:

Identifier	Color depth and orientation
<code>GUIDRV_SH_MEM</code>	1bpp, default orientation
<code>GUIDRV_SH_MEM_OSX</code>	1bpp, X and Y axis swapped, X mirrored (rotated CCW 90 degrees)
<code>GUIDRV_SH_MEM_OSY</code>	1bpp, X and Y axis swapped, Y mirrored (rotated CW 90 degrees)
<code>GUIDRV_SH_MEM_OXY</code>	1bpp, X and Y axis mirrored (turned by 180 degrees)
<code>GUIDRV_SH_MEM_3</code>	3bpp, default orientation
<code>GUIDRV_SH_MEM_OSX_3</code>	3bpp, X and Y axis swapped, X mirrored (rotated CCW 90 degrees)
<code>GUIDRV_SH_MEM_OSY_3</code>	3bpp, X and Y axis swapped, Y mirrored (rotated CW 90 degrees)
<code>GUIDRV_SH_MEM_OXY_3</code>	3bpp, X and Y axis mirrored (turned by 180 degrees)

### 13.7.14.3 Driver selection

The following command could be used in LCD\_X\_Config():

```
pDevice = GUI_DEVICE_CreateAndLink(GUIDRV_SH_MEM, GUICC_1, 0, 0);
```

### 13.7.14.4 Display data RAM organization 1bpp

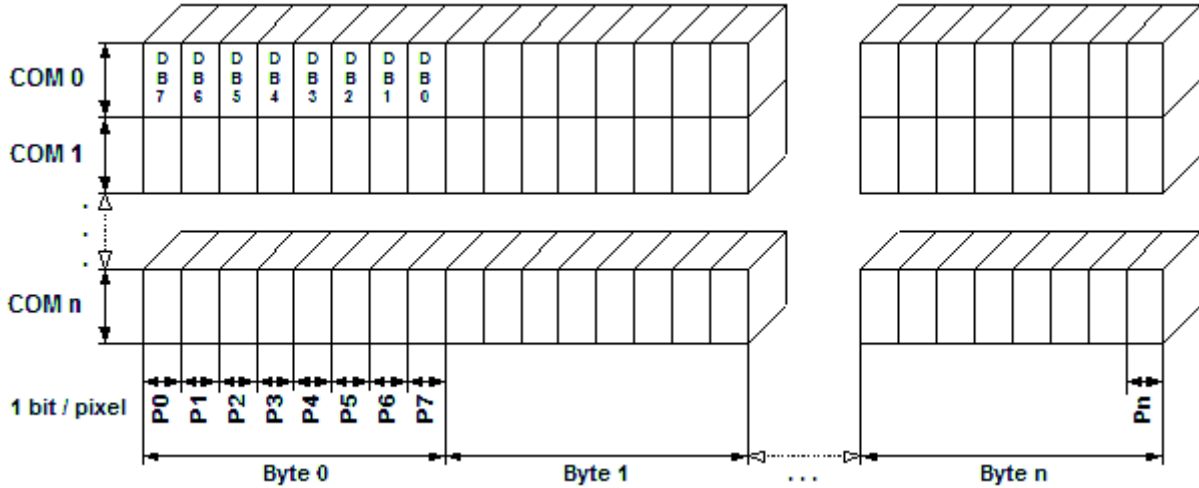

The picture above shows the relation between the display memory and the SEG and COM lines of the LCD.

### 13.7.14.5 Display data RAM organization 3bpp

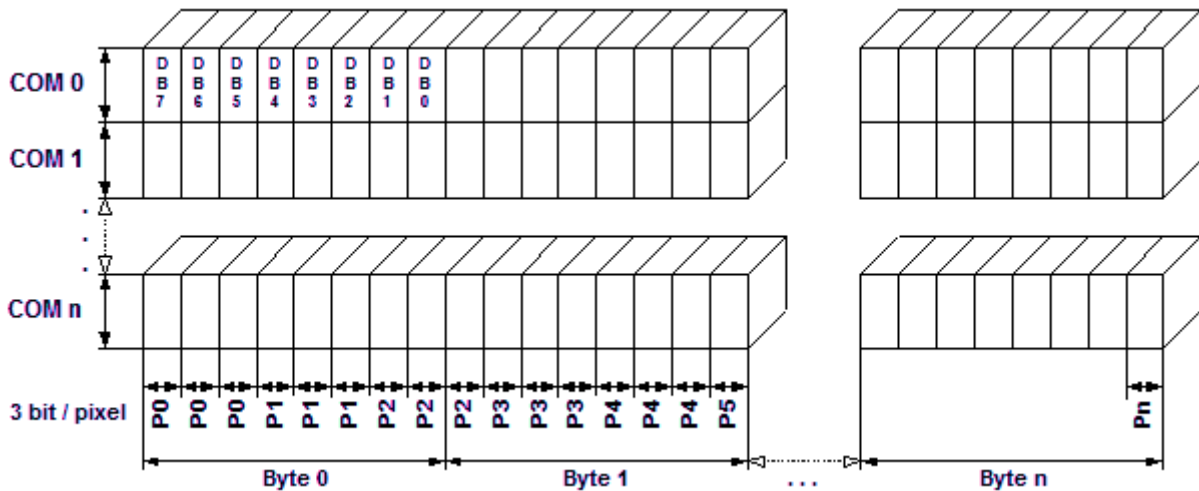

The picture above shows the relation between the display memory and the SEG and COM lines of the LCD.

### 13.7.14.6 RAM requirements

This display driver requires a display data cache containing a complete copy of the content of the LCD data RAM. The amount of memory used by the cache in bytes is:

$$\text{LCD\_YSIZE} * (\text{LCD\_XSIZE} * \text{BitsPerPixel} + 7) / 8 + (\text{LCD\_YSIZE} + 7) / 8$$

### 13.7.14.7 Run-time configuration

The table below shows the available run-time configuration routines of this driver:

Routine	Description
<code>GUIDRV_SH_MEM_Config()</code>	Passes a pointer to a <code>CONFIG_SH_MEM</code> structure to the driver.
<code>GUIDRV_SH_MEM_SetBus8()</code>	Tells the driver to use the 8 bit indirect interface and passes pointer to a <code>GUI_PORT_API</code> structure to the driver.
<code>GUIDRV_SH_MEM_3_Config()</code>	Passes a pointer to a <code>CONFIG_SH_MEM</code> structure to the driver.
<code>GUIDRV_SH_MEM_3_SetBus8()</code>	Tells the driver to use the 8 bit indirect interface and passes a pointer to a <code>GUI_PORT_API</code> structure to the driver containing function pointers to the hardware routines to be used.

### 13.7.14.7.1 GUIDRV\_SH\_MEM\_Config()

### 13.7.14.7.2 GUIDRV\_SH\_MEM\_3\_Config()

#### Description

Passes a pointer to a CONFIG\_SH\_MEM structure to the driver.

#### Prototype

```
void GUIDRV_SH_MEM_3_Config(GUI_DEVICE * pDevice,
                           CONFIG_SH_MEM * pConfig);
```

#### Parameters

Parameter	Description
pDevice	Pointer to the driver device.
pConfig	Pointer to a CONFIG_SH_MEM structure described below.

#### Additional information

In most cases the member 'SendEnd' of CONFIG\_SH\_MEM has to be set to 1. Some interfaces automatically send a 'line-end-command'. in this cases 'SendEnd' has to to be set to 0.

#### Elements of structure CONFIG\_SH\_MEM

Data type	Element	Description
unsigned	Period	Period for toggling VCOM. In case of 'ExtMode' is set to 1 the driver calls pfToggleVCOM with the given frequency. In case of 'ExtMode' is 0 it toggles the V-bit of the software interface.
unsigned	ExtMode	Should be set to the same value as the EXTMODE pin of the LCD. If set to 1 the function pointed by pfToggleVCOM is called periodically for toggling the VCOM pin by a custom function.
unsigned	ExtMode	(see table below)
void (*)(void)	pfToggleVCOM	Function for toggling the EXTCOMIN line of the display.
unsigned	AddressBitOrder	Inverts the bit order of the address.
unsigned	SendEnd	Enables sending of line-end-command.

Permitted values for BitMode	
GUIDRV_SH_MEM_8BITMODE	Default setting right for the most Memory LCDs.
GUIDRV_SH_MEM_10BITMODE	Must be used to support memory LCDs with 10 bit address interface like LS032B7DD02.

### 13.7.14.7.3 GUIDRV\_SH\_MEM\_SetBus8()

### 13.7.14.7.4 GUIDRV\_SH\_MEM\_3\_SetBus8()

#### Description

Tells the driver to use the 8 bit indirect interface and passes a pointer to a GUI\_PORT\_API structure to the driver containing function pointers to the hardware routines to be used.

#### Prototype

```
void GUIDRV_SH_MEM_3_SetBus8(GUI_DEVICE * pDevice,  
                             GUI_PORT_API * pHW_API);
```

#### Parameters

Parameter	Description
<code>pDevice</code>	Pointer to the driver device.
<code>pHW_API</code>	Pointer to a GUI_PORT_API structure. See required routines below.

### 13.7.14.8 Required GUI\_PORT\_API routines

Data type	Element	Description
void (*)(U8 NotActive)	<a href="#">pfSetCS</a>	Pointer to a function which is able to toggle the CS signal of the controller.
void (*)(U8 * pData, int NumItems)	<a href="#">pfWriteM8_A1</a>	Pointer to a function which writes multiple bytes to the controller.

### 13.7.14.9 Configuration Example

```

#define XSIZE 128
#define YSIZE 128
GUI_PORT_API _PortAPI;
void LCD_X_Config(void) {
    GUI_DEVICE * pDevice;
    GUI_PORT_API PortAPI = {0};
    CONFIG_SH_MEM Config = {0};
    //
    // Set display driver and color conversion
    //
    pDevice = GUI_DEVICE_CreateAndLink(GUIDRV_SH_MEM, GUICC_1, 0, 0);
    //
    // Common display driver configuration
    //
    if (LCD_GetSwapXY()) {
        LCD_SetSizeEx (0, YSIZE_PHYS, XSIZE_PHYS);
    } else {
        LCD_SetSizeEx (0, XSIZE_PHYS, YSIZE_PHYS);
    }
    //
    // Setup hardware access routines
    //
    PortAPI.pfWriteM8_A1 = _WriteM1;
    PortAPI.pfSetCS      = _SetCS;
    GUIDRV_SH_MEM_SetBus8(pDevice, &PortAPI);
    //
    // VCom management
    //
    Config.Period  = 500;
    Config.SendEnd = 1;
    GUIDRV_SH_MEM_Config(pDevice, &Config);
}

```

## 13.7.15 GUIDRV\_SLin

### 13.7.15.1 Supported hardware

#### Controllers

The driver works with the following display controllers:

- Epson S1D13700, S1D13305 (indirect interface only!)
- RAI0 8835
- Solomon SSD1325, SSD1848
- Ultrachip UC1617
- Toshiba T6963

#### Bits per pixel

Supported color depth is 1, 2 and 4 bits per pixel. Please consider that the supported controllers normally do not support all possible color depths to be used with the driver.

#### Interfaces

The driver supports the 8 bit indirect interface.

### 13.7.15.2 Color depth and display orientation

The driver can be used with different orientations and color depths. The following table shows the configuration macros which can be used to create and link the driver during the initialization:

Identifier	Color depth and orientation
GUIDRV_SLIN_1	1bpp, default orientation
GUIDRV_SLIN_OY_1	1bpp, Y axis mirrored
GUIDRV_SLIN_OX_1	1bpp, X axis mirrored
GUIDRV_SLIN_OXY_1	1bpp, X and Y axis mirrored
GUIDRV_SLIN_OS_1	1bpp, X and Y swapped
GUIDRV_SLIN_OSY_1	1bpp, X and Y swapped, Y axis mirrored
GUIDRV_SLIN_OSX_1	1bpp, X and Y swapped, X axis mirrored
GUIDRV_SLIN_OSXY_1	1bpp, X and Y swapped, X and Y axis mirrored
GUIDRV_SLIN_2	2bpp, default orientation
GUIDRV_SLIN_OY_2	2bpp, Y axis mirrored
GUIDRV_SLIN_OX_2	2bpp, X axis mirrored
GUIDRV_SLIN_OXY_2	2bpp, X axis mirrored, Y axis mirrored
GUIDRV_SLIN_OS_2	2bpp, X and Y swapped
GUIDRV_SLIN_OSY_2	2bpp, X and Y swapped, Y axis mirrored
GUIDRV_SLIN_OSX_2	2bpp, X and Y swapped, X axis mirrored
GUIDRV_SLIN_OSXY_2	2bpp, X and Y swapped, Y and X axis mirrored
GUIDRV_SLIN_4	4bpp, default orientation
GUIDRV_SLIN_OY_4	4bpp, Y axis mirrored
GUIDRV_SLIN_OX_4	4bpp, X axis mirrored
GUIDRV_SLIN_OXY_4	4bpp, X axis mirrored, Y axis mirrored
GUIDRV_SLIN_OS_4	4bpp, X and Y swapped
GUIDRV_SLIN_OSY_4	4bpp, X and Y swapped, Y axis mirrored
GUIDRV_SLIN_OSX_4	4bpp, X and Y swapped, X axis mirrored

Identifier	Color depth and orientation
GUIDRV_SLIN_OSXY_4	4bpp, X and Y swapped, Y and X axis mirrored

### 13.7.15.3 Driver selection

To use GUIDRV\_SLin for the given display, the following command can be used e.g.:

```
pDevice = GUI_DEVICE_CreateAndLink(GUIDRV_SLIN_OX_1, GUICC_1, 0, 0);
```

Detailed information about palette modes can be found in the chapter *Colors* on page 604.

### 13.7.15.4 Display data RAM organization

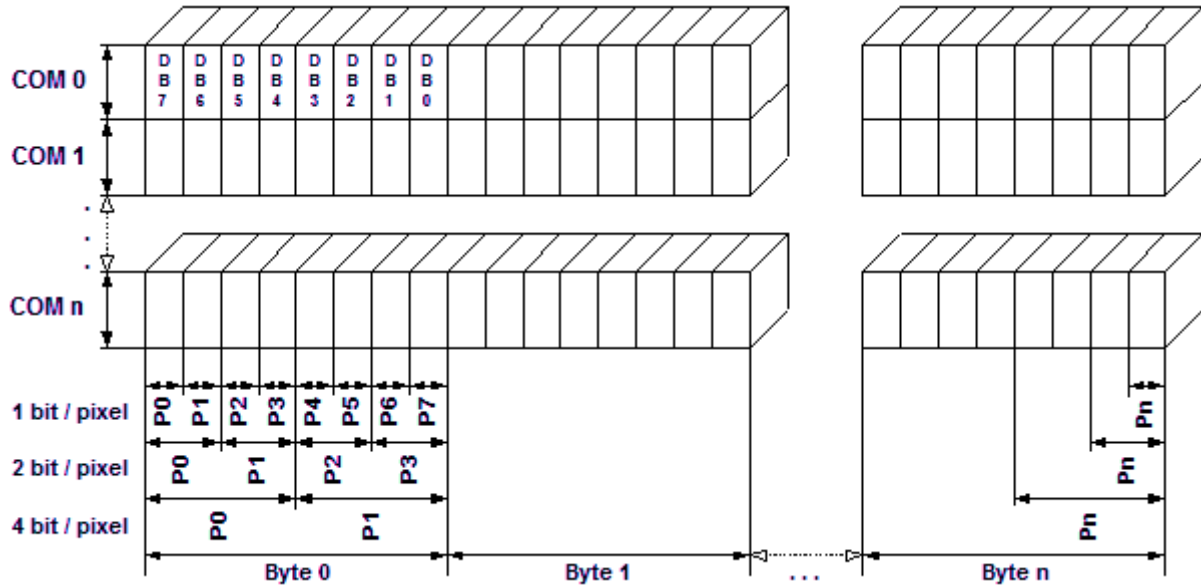

The picture above shows the relation between the display memory and the SEG and COM lines of the display.

### 13.7.15.5 RAM requirements

This display driver may be used with or without a display data cache, containing a complete copy of the frame buffer. If no cache is used, the driver only requires approx. 256 bytes of RAM.

It is recommended to use this driver with a data cache for faster LCD-access. The additional amount of memory used by the cache may be calculated as follows:

$$\text{Size of RAM (in bytes)} = \text{BitsPerPixel} * (\text{LCD\_XSIZE} + 7) / 8 * \text{LCD\_YSIZE}$$

### 13.7.15.6 Run-time configuration

The table below shows the available run-time configuration routines of this driver:

Routine	Description
<code>GUIDRV_SLin_Config()</code>	Passes a pointer to a <code>CONFIG_SLIN</code> structure to the driver.
<code>GUIDRV_SLin_SetBus8()</code>	Tells the driver to use the 8 bit indirect interface and passes pointer to a <code>GUI_PORT_API</code> structure to the driver.
<code>GUIDRV_SLin_SetS1D13700()</code>	Set up the driver to use one of the following controllers: <ul style="list-style-type: none"> <li>Epson S1D13700, S1D13305</li> </ul>



Routine	Description
	<ul style="list-style-type: none"><li>• RAI0 8835</li></ul>
<code>GUIDRV_SLin_SetSSD1325()</code>	Set up the driver to use one of the following controllers: <ul style="list-style-type: none"><li>• Solomon SSD1325</li><li>• Solomon SSD1327</li></ul>
<code>GUIDRV_SLin_SetSSD1848()</code>	Set up the driver to use one of the following controllers: <ul style="list-style-type: none"><li>• Solomon SSD1848</li></ul>
<code>GUIDRV_SLin_SetT6963()</code>	Set up the driver to use one of the following controllers: <ul style="list-style-type: none"><li>• Toshiba T6963</li></ul>
<code>GUIDRV_SLin_SetUC1617()</code>	Set up the driver to use one of the following controllers: <ul style="list-style-type: none"><li>• Ultrachip UC1617</li></ul>

### 13.7.15.6.1 GUIDRV\_SLin\_Config()

#### Description

Passes a pointer to a CONFIG\_SLIN structure to the driver.

#### Prototype

```
void GUIDRV_SLin_Config(GUI_DEVICE * pDevice,
                       CONFIG_SLIN * pConfig);
```

#### Parameters

Parameter	Description
<code>pDevice</code>	Pointer to the driver device.
<code>pConfig</code>	Pointer to a CONFIG_SLIN structure described below.

#### Elements of structure CONFIG\_SLIN

Data type	Element	Description
int	FirstSEG	First segment address to be used in the data RAM of the display controller. The value can be determined experimentally or taken from the display documentation. The value is normally 0.
int	FirstCOM	First common address to be used in the data RAM of the display controller. The value can be determined experimentally or taken from the display documentation. The value is normally 0.
int	UseCache	Enables or disables use of a data cache. Should be set to 1 for enabling and to 0 for disabling.
int	UseDualScan	Used only for the T6963. This element should be set to 1 in case a dual screen LCD is used.
int	UseMirror	Used only for the SSD1848. Should be normally 1.

### 13.7.15.6.2 GUIDRV\_SLin\_SetBus8()

#### Description

Tells the driver to use the 16 bit indirect interface and passes a pointer to a GUI\_PORT\_API structure to the driver containing function pointers to the hardware routines to be used.

#### Prototype

```
void GUIDRV_Slin_SetBus8(GUI_DEVICE * pDevice,
                        GUI_PORT_API * pHW_API);
```

#### Parameters

Parameter	Description
<a href="#">pDevice</a>	Pointer to the driver device
<a href="#">pHW_API</a>	Pointer to a GUI_PORT_API structure. See required routines below.

#### Required GUI\_PORT\_API routines

Element	Data type
<a href="#">pfWrite8_A0</a>	void (*)(U8 Data)
<a href="#">pfWrite8_A1</a>	void (*)(U8 Data)
<a href="#">pfWriteM8_A0</a>	void (*)(U8 * pData, int NumItems)
<a href="#">pfWriteM8_A1</a>	void (*)(U8 * pData, int NumItems)
<a href="#">pfRead8_A1</a>	U8 (*)(void)

### 13.7.15.6.3 GUIDRV\_SLin\_SetS1D13700()

#### Description

Tells the driver that an Epson S1D13700 or S1D13305 controller should be used. Works also for RAIO 8835.

#### Prototype

```
void GUIDRV_SLin_SetS1D13700(GUI_DEVICE * pDevice);
```

#### Parameters

Parameter	Description
<code>pDevice</code>	Pointer to the driver device

#### 13.7.15.6.4 GUIDRV\_SLin\_SetSSD1325()

##### Description

Tells the driver that a Solomon SSD1325 controller should be used.

##### Prototype

```
void GUIDRV_SLin_SetSSD1325(GUI_DEVICE * pDevice);
```

##### Parameters

Parameter	Description
<code>pDevice</code>	Pointer to the driver device

### 13.7.15.6.5 GUIDRV\_SLin\_SetSSD1848()

#### Description

Tells the driver that a Solomon SSD1848 controller should be used.

#### Prototype

```
void GUIDRV_SLin_SetSSD1848(GUI_DEVICE * pDevice);
```

#### Parameters

Parameter	Description
<code>pDevice</code>	Pointer to the driver device

### 13.7.15.6.6 GUIDRV\_SLin\_SetT6963()

#### Description

Tells the driver that a Toshiba T6963 controller should be used.

#### Prototype

```
void GUIDRV_SLin_SetT6963(GUI_DEVICE * pDevice);
```

#### Parameters

Parameter	Description
<code>pDevice</code>	Pointer to the driver device

### 13.7.15.6.7 GUIDRV\_SLin\_SetUC1617()

#### Description

Tells the driver that an Ultrachip UC1617 controller should be used.

#### Prototype

```
void GUIDRV_SLin_SetUC1617(GUI_DEVICE * pDevice);
```

#### Parameters

Parameter	Description
<code>pDevice</code>	Pointer to the driver device



### 13.7.15.7 Configuration example

```
#define YSIZE 240
void LCD_X_Config(void) {
    GUI_DEVICE * pDevice;
    CONFIG_SLIN Config = {0};
    GUI_PORT_API PortAPI = {0};
    //
    // Set display driver and color conversion
    //
    pDevice = GUI_DEVICE_CreateAndLink(GUIDRV_SLIN_2, GUICC_2, 0, 0);
    //
    // Common display driver configuration
    //
    LCD_SetSizeEx (0, XSIZE, YSIZE);
    LCD_SetVSizeEx(0, XSIZE, YSIZE);
    //
    // Driver specific configuration
    //
    Config.UseCache = 1;
    GUIDRV_SLin_Config(pDevice, &Config);
    //
    // Select display controller
    //
    GUIDRV_SLin_SetS1D13700(pDevice);
    //
    // Setup hardware access routines
    //
    PortAPI.pfWrite16_A0 = _Write0;
    PortAPI.pfWrite16_A1 = _Write1;
    PortAPI.pfWriteM16_A0 = _WriteM0;
    PortAPI.pfRead16_A1 = _Read1;
    GUIDRV_SLin_SetBus8(pDevice, &PortAPI);
}
```

## 13.7.16 GUIDRV\_SLinEPD

### 13.7.16.1 Description

This driver is written to drive an electronic paper display (EPD) controller. Since EPD controller do not behave like typical LCD controllers it requires some special treatment.

#### Updating the display

Since most devices using an EPD are designed to have a low power consumption emWin puts the EPD controller into a deep sleep mode after performing a screen update. When writing to the display emWin sends a `LCD_X_INITCONTROLLER` command to the driver callback `LCD_X_DisplayDriver()` to wake up the controller. Therefore `LCD_X_DisplayDriver()` gets called multiple times with `LCD_X_INITCONTROLLER` command.

The user has multiple options to update the screen after performing drawing operations with emWin.

- Call `LCD_Refresh()`
- Configure the driver for auto update mode
- Locking and unlocking the cache (for UC8451)

Per default the driver does not update the screen automatically and the user has to call `LCD_Refresh()` manually after performing the last drawing operation.

The `GUIDRV_SLinEPD` driver offers an auto update mode. When using this mode the driver checks periodically for changes in the driver cache and updates the screen automatically if changes are detected. This mode can be enabled by setting an auto update period with the function `GUIDRV_SLinEPD_Config()`.

#### Partial update

Per default the driver refreshes the entire display if `LCD_Refresh()` gets called or the a change is detected in auto update mode. With the function `GUIDRV_SLinEPD_EnablePartialMode()` it is possible to update only changed areas of the screen to reduce BUS traffic.

Due to the nature of EPDs this mode might cause artifacts on the screen showing the previous content ("ghosting" effect). This is caused by non-initialized pixels on the EPD.

The UltraChip UC8451 is always in partial mode and updates only the necessary parts of the display.

#### Fast update

The UltraChip UC8451 provides a fast update mode which allows a quick refresh of the display. The downside of fast updates is that the display is not thoroughly cleared of previous pixels which means that "ghosting" effects can be noticed.

Fast update mode can be enabled or disabled using the routine `GUIDRV_SLinEPD_EnableFastMode()`.

### 13.7.16.2 Supported hardware

#### Controllers

The driver works with the following display controllers:

- Solomon SSD1673, SSD1680
- UltraChip UC8451

#### Bits per pixel

The driver currently supports 1 bpp color depth.

## Interfaces

The driver supports the indirect interface (8 bit) of the display controller. Parallel, 4-pin SPI or I2C bus can be used.

### 13.7.16.3 Color depth and display orientation

The driver can be used with different orientations and 1bpp color depth. Each configuration requires a display driver cache. The following table shows the configuration macros which can be used to create and link the driver during the initialization:

Identifier	Color depth	Cache	Orientation
GUIDRV_SLINEPD_1	1bpp	Yes	default
GUIDRV_SLINEPD_OY_1	1bpp	Yes	Y axis mirrored
GUIDRV_SLINEPD_OX_1	1bpp	Yes	X axis mirrored
GUIDRV_SLINEPD_OXY_1	1bpp	Yes	X and Y axis mirrored
GUIDRV_SLINEPD_OS_1	1bpp	Yes	X and Y swapped
GUIDRV_SLINEPD_OSY_1	1bpp	Yes	X and Y swapped, Y axis mirrored
GUIDRV_SLINEPD_OSX_1	1bpp	Yes	X and Y swapped, X axis mirrored
GUIDRV_SLINEPD_OSXY_1	1bpp	Yes	X and Y swapped, X and Y axis mirrored

### 13.7.16.4 Driver selection

To use GUIDRV\_SLINEPD for the given display, the following call may be used in the function LCD\_X\_Config:

```
pDevice = GUI_DEVICE_CreateAndLink(GUIDRV_SLINEPD_1, GUICC_1, 0, 0);
```

Detailed information about palette modes can be found in the chapter *Colors* on page 604.

### 13.7.16.5 Display data RAM organization

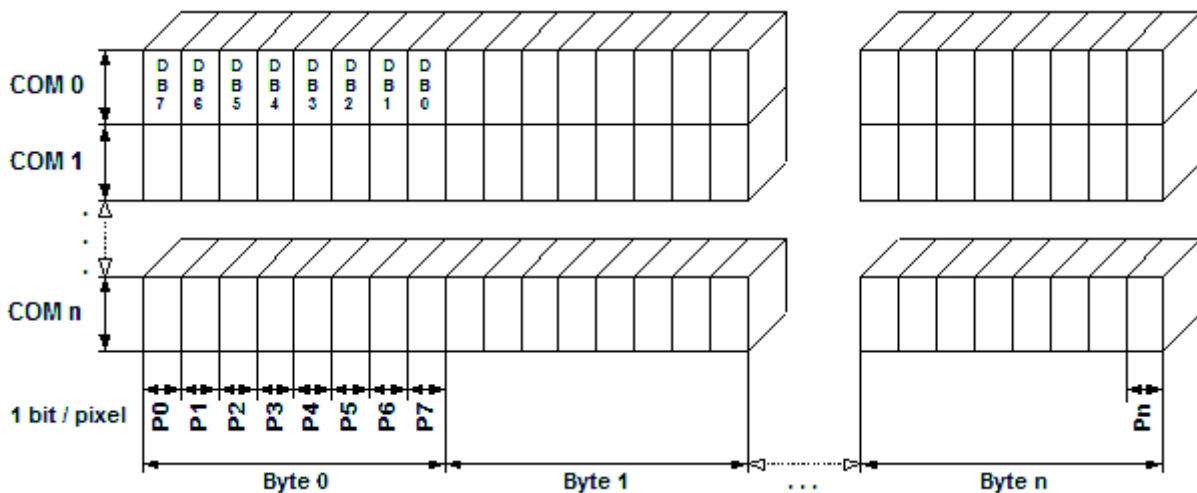

### 13.7.16.6 RAM requirements

This display driver requires a display data cache. The data cache contains a complete copy of the LCD data RAM. The amount of memory used by the cache may be calculated as follows:

```
LCD_PIXELPERBYTE == 8
Size of RAM (in bytes) = ((LCD_XSIZE + (LCD_PIXELPERBYTE - 1)) /
LCD_PIXELPERBYTE) * LCD_YSIZE
```

## UltraChip UC8451

The UltraChip UC8451 in **fast update mode** requires two caches to be present in RAM. To calculate the RAM requirement, the above formula can be doubled.

### 13.7.16.7 Run-time configuration

The table below shows the available run-time configuration routines for this driver:

Routine	Description
<code>GUIDRV_SLinEPD_Config()</code>	Passes a <code>CONFIG_SLINEPD</code> structure to the driver.
<code>GUIDRV_SLinEPD_EnableFastMode()</code>	Enables/disables fast update mode for UC8451.
<code>GUIDRV_SLinEPD_EnablePartialMode()</code>	Enables/disables partial update mode for SSD1673.
<code>GUIDRV_SLinEPD_SetBus8()</code>	Sets the interface for the driver.
<code>GUIDRV_SLinEPD_SetSSD1673()</code>	Selects SSD1673 to be driven by the driver.
<code>GUIDRV_SLinEPD_SetUC8451()</code>	Selects UC8451 to be driven by the driver.

### 13.7.16.7.1 GUIDRV\_SLinEPD\_Config()

#### Description

Passes a CONFIG\_SLINEPD structure to the driver.

#### Prototype

```
void GUIDRV_SLinEPD_Config(GUI_DEVICE      * pDevice,  
                           CONFIG_SLINEPD * pConfig);
```

#### Parameters

Parameter	Description
<a href="#">pDevice</a>	Pointer to the driver device.
<a href="#">pConfig</a>	Pointer to a CONFIG_SLINEPD structure described below.

#### Additional information

This driver has an auto update mode. This mode uses a timer which checks periodically if the data in the cache have changed. If this is the reason the timer causes the driver to perform an update of the LCD.

If this function is not called the driver does not use the auto update mode.

### 13.7.16.7.2 GUIDRV\_SLinEPD\_EnableFastMode()

#### Description

Enables fast update mode for the following controllers:

UltraChip  
UC8451

#### Prototype

```
void GUIDRV_SLinEPD_EnableFastMode(int OnOff);
```

#### Parameters

Parameter	Description
OnOff	0 for disabling, 1 for enabling.

#### Additional information

Fast update mode requires a second cache the size of the display. By default, fast update mode is disabled.

### 13.7.16.7.3 GUIDRV\_SLinEPD\_EnablePartialMode()

#### Description

This function enables the partial update mode for the following controllers:

Solomon  
SSD1673  
Solomon  
SSD1680

#### Prototype

```
void GUIDRV_SLinEPD_EnablePartialMode(int OnOff);
```

#### Parameters

Parameter	Description
<code>OnOff</code>	Enables (1) or disables (0) the partial update mode.

#### 13.7.16.7.4 GUIDRV\_SLinEPD\_SetBus8()

##### Description

Tells the driver to use the 8 bit indirect interface and passes a pointer to a GUI\_PORT\_API structure to the driver containing function pointers to the hardware routines to be used.

##### Prototype

```
void GUIDRV_SLinEPD_SetBus8(GUI_DEVICE * pDevice,  
                             GUI_PORT_API * pHW_API);
```

##### Parameters

Parameter	Description
<a href="#">pDevice</a>	Pointer to the driver device.
<a href="#">pHW_API</a>	Pointer to a GUI_PORT_API structure. See required routines below.



### 13.7.16.7.5 GUIDRV\_SLinEPD\_SetSSD1673()

#### Description

Configures the driver to use one of the following controllers:

Solomon  
SSD1673

#### Prototype

```
void GUIDRV_SLinEPD_SetSSD1673(GUI_DEVICE * pDevice);
```

#### Parameters

Parameter	Description
<code>pDevice</code>	Pointer to the driver device.

### 13.7.16.7.6 GUIDRV\_SLinEPD\_SetUC8451()

#### Note

When using the UC8451 controller, the cache has to be locked when performing drawing operations using `LCD_ControlCache(LCD_CC_LOCK)` and `LCD_ControlCache(LCD_CC_UNLOCK)`. Unlocking the cache when the drawing operations are finished will result in a flush of the cache to the hardware and an update of the display contents. This only has to be done if the window manager is not used, since the window manager locks and unlocks the cache automatically.

#### Description

Configures the driver to use one of the following controllers:

UltraChip  
8451

#### Prototype

```
void GUIDRV_SLinEPD_SetUC8451(GUI_DEVICE * pDevice);
```

#### Parameters

Parameter	Description
<code>pDevice</code>	Pointer to the driver device.

### 13.7.16.8 Configuration example

```
void LCD_X_Config(void) {
    GUI_DEVICE      * pDevice;
    GUI_PORT_API    PortAPI = {0};
    CONFIG_SLINEPD  Config = {0};
    //
    // Set display driver and color conversion for 1st layer
    //
    pDevice = GUI_DEVICE_CreateAndLink(GUIDRV_SLINEPD_1, GUICC_1, 0, 0);
    //
    // Display driver configuration
    //
    if (LCD_GetSwapXY()) {
        LCD_SetSizeEx (0, YSIZE_PHYS, XSIZE_PHYS);
        LCD_SetVSizeEx(0, YSIZE_PHYS, XSIZE_PHYS);
    } else {
        LCD_SetSizeEx (0, XSIZE_PHYS, YSIZE_PHYS);
        LCD_SetVSizeEx(0, XSIZE_PHYS, YSIZE_PHYS);
    }
    //
    // Choose controller
    //
    GUIDRV_SLinEPD_SetSSD1673(pDevice);
    //
    // Set up port API
    //
    PortAPI.pfWrite8_A0 = _Write8_A0;
    PortAPI.pfWrite8_A1 = _Write8_A1;
    PortAPI.pfWriteM8_A1 = _WriteM8_A1;
    PortAPI.pfRead8_A0  = _Read8_A0;
    GUIDRV_SLinEPD_SetBus8(pDevice, &PortAPI);
    //
    // Auto-Update
    //
    Config.AutoUpdatePeriod = 1000;
    GUIDRV_SLinEPD_Config(pDevice, &Config);
}
```

## 13.7.17 GUIDRV\_SPage

### 13.7.17.1 Supported hardware

#### Controllers

The driver works with the following display controllers:

- Avant Electronics SBN0064G
- Epson S1D15E05, S1D15E06, S1D15605, S1D15606, S1D15607, S1D15608, S1D15705, S1D15710, S1D15714, S1D15719, S1D15721
- Integrated Solutions Technology IST3020, IST3501
- New Japan Radio Company NJU6676
- Novatek NT7502, NT7534, NT7538, NT75451
- Samsung S6B0713, S6B0719, S6B0724, S6B1713
- Sino Wealth SH1101A
- Sitronix ST7522, ST75256, ST75320, ST7565, ST7567, ST7570, ST7591
- Solomon SSD1303, SSD1305, SSD1306, SSD1309, SSD1805, SSD1815
- Sunplus SPLC501C
- UltraChip UC1601, UC1606, UC1608, UC1611, UC1628, UC1638, UC1701

#### Bits per pixel

The driver currently supports 1, 2 and 4 bpp resolutions.

#### Interfaces

The driver supports the indirect interface (8 bit) of the display controller. Parallel, 4-pin SPI or I2C bus can be used.

### 13.7.17.2 Color depth and display orientation

The driver can be used with different orientations and color depths. Each configuration can be used with or without a display driver cache. The following table shows the configuration macros which can be used to create and link the driver during the initialization:

Identifier	Color depth	Cache	Orientation
GUIDRV_SPAGE_1C0	1bpp	No	default
GUIDRV_SPAGE_OY_1C0	1bpp	No	Y axis mirrored
GUIDRV_SPAGE_OX_1C0	1bpp	No	X axis mirrored
GUIDRV_SPAGE_OXY_1C0	1bpp	No	X and Y axis mirrored
GUIDRV_SPAGE_OS_1C0	1bpp	No	X and Y swapped
GUIDRV_SPAGE_OSY_1C0	1bpp	No	X and Y swapped, Y axis mirrored
GUIDRV_SPAGE_OSX_1C0	1bpp	No	X and Y swapped, X axis mirrored
GUIDRV_SPAGE_OSXY_1C0	1bpp	No	X and Y swapped, X and Y axis mirrored
GUIDRV_SPAGE_1C1	1bpp	Yes	default
GUIDRV_SPAGE_OY_1C1	1bpp	Yes	Y axis mirrored
GUIDRV_SPAGE_OX_1C1	1bpp	Yes	X axis mirrored
GUIDRV_SPAGE_OXY_1C1	1bpp	Yes	X and Y axis mirrored
GUIDRV_SPAGE_OS_1C1	1bpp	Yes	X and Y swapped
GUIDRV_SPAGE_OSY_1C1	1bpp	Yes	X and Y swapped, Y axis mirrored
GUIDRV_SPAGE_OSX_1C1	1bpp	Yes	X and Y swapped, X axis mirrored
GUIDRV_SPAGE_OSXY_1C1	1bpp	Yes	X and Y swapped, X and Y axis mirrored
GUIDRV_SPAGE_2C0	2bpp	No	default

Identifier	Color depth	Cache	Orientation
GUIDRV_SPAGE_OY_2C0	2bpp	No	Y axis mirrored
GUIDRV_SPAGE_OX_2C0	2bpp	No	X axis mirrored
GUIDRV_SPAGE_OXY_2C0	2bpp	No	X and Y axis mirrored
GUIDRV_SPAGE_OS_2C0	2bpp	No	X and Y swapped
GUIDRV_SPAGE_OSY_2C0	2bpp	No	X and Y swapped, Y axis mirrored
GUIDRV_SPAGE_OSX_2C0	2bpp	No	X and Y swapped, X axis mirrored
GUIDRV_SPAGE_OSXY_2C0	2bpp	No	X and Y swapped, X and Y axis mirrored
GUIDRV_SPAGE_2C1	2bpp	Yes	default
GUIDRV_SPAGE_OY_2C1	2bpp	Yes	Y axis mirrored
GUIDRV_SPAGE_OX_2C1	2bpp	Yes	X axis mirrored
GUIDRV_SPAGE_OXY_2C1	2bpp	Yes	X and Y axis mirrored
GUIDRV_SPAGE_OS_2C1	2bpp	Yes	X and Y swapped
GUIDRV_SPAGE_OSY_2C1	2bpp	Yes	X and Y swapped, Y axis mirrored
GUIDRV_SPAGE_OSX_2C1	2bpp	Yes	X and Y swapped, X axis mirrored
GUIDRV_SPAGE_OSXY_2C1	2bpp	Yes	X and Y swapped, X and Y axis mirrored
GUIDRV_SPAGE_4C0	4bpp	No	default
GUIDRV_SPAGE_OY_4C0	4bpp	No	Y axis mirrored
GUIDRV_SPAGE_OX_4C0	4bpp	No	X axis mirrored
GUIDRV_SPAGE_OXY_4C0	4bpp	No	X and Y axis mirrored
GUIDRV_SPAGE_OS_4C0	4bpp	No	X and Y swapped
GUIDRV_SPAGE_OSY_4C0	4bpp	No	X and Y swapped, Y axis mirrored
GUIDRV_SPAGE_OSX_4C0	4bpp	No	X and Y swapped, X axis mirrored
GUIDRV_SPAGE_OSXY_4C0	4bpp	No	X and Y swapped, X and Y axis mirrored
GUIDRV_SPAGE_4C1	4bpp	Yes	default
GUIDRV_SPAGE_OY_4C1	4bpp	Yes	Y axis mirrored
GUIDRV_SPAGE_OX_4C1	4bpp	Yes	X axis mirrored
GUIDRV_SPAGE_OXY_4C1	4bpp	Yes	X and Y axis mirrored
GUIDRV_SPAGE_OS_4C1	4bpp	Yes	X and Y swapped
GUIDRV_SPAGE_OSY_4C1	4bpp	Yes	X and Y swapped, Y axis mirrored
GUIDRV_SPAGE_OSX_4C1	4bpp	Yes	X and Y swapped, X axis mirrored
GUIDRV_SPAGE_OSXY_4C1	4bpp	Yes	X and Y swapped, X and Y axis mirrored

### Important note for mirroring

As far as we know nearly all supported controllers of this driver support hardware mirroring for X- and Y-axis. If one or both of axis need to be mirrored it is highly recommended to use the hardware commands for mirroring within the initialization sequence of the controller, because software mirroring could cause a negative effect on the performance.

### 13.7.17.3 Driver selection

To use GUIDRV\_SPage for the given display, the following call may be used in the function LCD\_X\_Config:

```
pDevice = GUI_DEVICE_CreateAndLink(GUIDRV_SPAGE_4C0, GUICC_4, 0, 0);
```

Detailed information about palette modes can be found in the chapter *Colors* on page 604.

### 13.7.17.4 Display data RAM organization

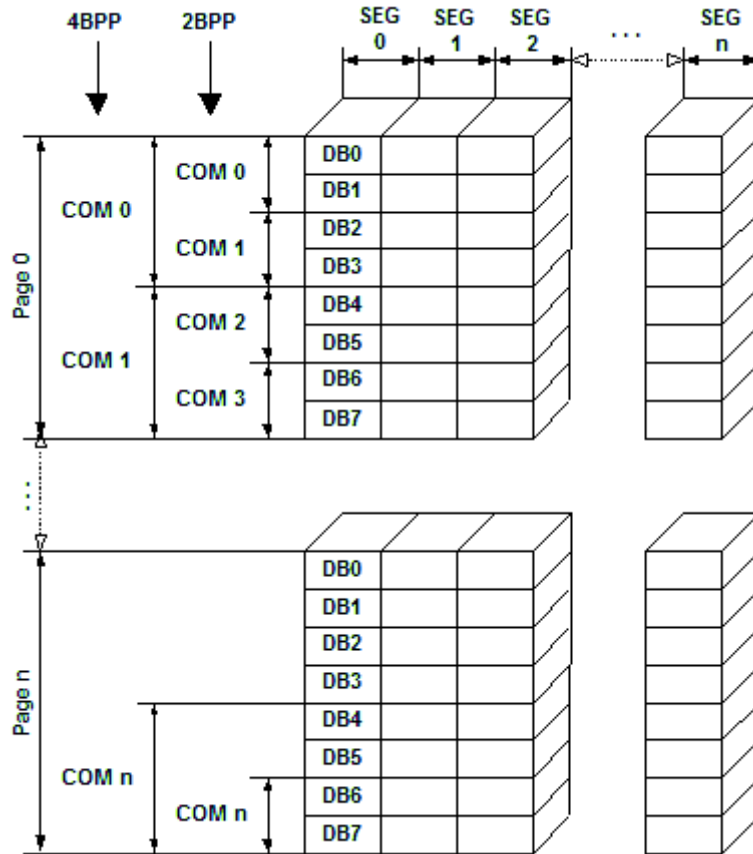

The picture above shows the relation between the display memory and the SEG and COM lines of the display.

### 13.7.17.5 RAM requirements

This display driver can be used with or without a display data cache. The data cache contains a complete copy of the LCD data RAM. If no cache is used, there are no additional RAM requirements.

It is highly recommended to use this driver with a data cache for faster LCD-access. Not using a cache degrades the performance of this driver seriously. The amount of memory used by the cache may be calculated as follows:

$$\text{Size of RAM (in bytes)} = (\text{LCD\_YSIZE} + (8 / \text{LCD\_BITSPERPIXEL} - 1)) / 8 * \text{LCD\_BITSPERPIXEL} * \text{LCD\_XSIZE}$$

### 13.7.17.6 Run-time configuration

The table below shows the available run-time configuration routines for this driver:

Routine	Description
<code>GUIDRV_SPage_Config()</code>	Passes a pointer to a <code>CONFIG_SPAGE</code> structure.
<code>GUIDRV_SPage_SetBus8()</code>	Configures the driver to use the 8 bit indirect interface and passes a pointer to a <code>GUI_PORT_API</code> structure to the driver.

Routine	Description
<code>GUIDRV_SPage_Set1502()</code>	Set up the driver to use one of the following controllers: <ul style="list-style-type: none"> <li>• Avant Electronics SBN0064G</li> <li>• Hitachi HD61202</li> <li>• S6B0108 (KS0108)</li> </ul>
<code>GUIDRV_SPage_Set1510()</code>	Set up the driver to use one of the following controllers: <ul style="list-style-type: none"> <li>• Epson S1D15605, S1D15606, S1D15607, S1D15608, S1D15705, S1D15710, S1D15714</li> <li>• Integrated Solutions Technology IST3020</li> <li>• New Japan Radio Company NJU6676</li> <li>• Novatek NT7502, NT7534, NT7538, NT75451</li> <li>• OriseTech SPLC502B</li> <li>• Samsung S6B0713, S6B0719, S6B0724, S6B1713</li> <li>• Sino Wealth SH1101A</li> <li>• Sitronix ST7522, ST7565, ST7567, ST7570, ST7571</li> <li>• Solomon SSD1303, SSD1305, SSD1805, SSD1815, SSD1821</li> <li>• Sunplus SPLC501C</li> <li>• UltraChip UC1601, UC1606, UC1608, UC1701</li> </ul>
<code>GUIDRV_SPage_Set1512()</code>	Set up the driver to use one of the following controllers: <ul style="list-style-type: none"> <li>• Epson S1D15E05, S1D15E06, S1D15719, S1D15721</li> <li>• Integrated Solutions Technology IST3501</li> </ul>
<code>GUIDRV_SPage_SetST75256()</code>	Set up the driver to use the following controllers: <ul style="list-style-type: none"> <li>• Sitronix ST75256, ST75160</li> </ul>
<code>GUIDRV_SPage_SetST75320()</code>	Set up the driver to use the following controller: <ul style="list-style-type: none"> <li>• Sitronix ST75320</li> <li>• Sitronix ST7592</li> </ul>
<code>GUIDRV_SPage_SetST7591()</code>	Set up the driver to use the following controller: <ul style="list-style-type: none"> <li>• Sitronix ST7591</li> </ul>
<code>GUIDRV_SPage_SetUC1610()</code>	Set up the driver to use the following controller: <ul style="list-style-type: none"> <li>• UltraChip UC1610</li> </ul>
<code>GUIDRV_SPage_SetUC1611()</code>	Set up the driver to use the following controller: <ul style="list-style-type: none"> <li>• UltraChip UC1611</li> </ul>
<code>GUIDRV_SPage_SetUC1628()</code>	Set up the driver to use the following controller: <ul style="list-style-type: none"> <li>• UltraChip UC1628</li> </ul>
<code>GUIDRV_SPage_SetUC1638()</code>	Set up the driver to use the following controller: <ul style="list-style-type: none"> <li>• UltraChip UC1638</li> </ul>

### 13.7.17.6.1 GUIDRV\_SPage\_Config()

#### Description

Passes a pointer to a `CONFIG_SPAGE` structure to the driver.

#### Prototype

```
void GUIDRV_SPage_Config(GUI_DEVICE * pDevice,
                        CONFIG_SPAGE * pConfig);
```

#### Parameters

Parameter	Description
<code>pDevice</code>	Pointer to the driver device.
<code>pConfig</code>	Pointer to a <code>CONFIG_SPAGE</code> structure described below.

#### Elements of structure `CONFIG_SPAGE`

Data type	Element	Description
<code>int</code>	<code>FirstSEG</code>	First segment address to be used in the data RAM of the display controller. The value can be determined experimentally or taken from the display documentation. The value is normally 0.
<code>int</code>	<code>FirstCOM</code>	First common address to be used in the data RAM of the display controller. The value can be determined experimentally or taken from the display documentation. The value is normally 0.



### 13.7.17.6.2 GUIDRV\_SPage\_SetBus8()

#### Description

Tells the driver to use the 8 bit indirect interface and passes a pointer to a GUI\_PORT\_API structure to the driver containing function pointers to the hardware routines to be used.

#### Prototype

```
void GUIDRV_SPage_SetBus8(GUI_DEVICE * pDevice,
                          GUI_PORT_API * pHW_API);
```

#### Parameters

Parameter	Description
<code>pDevice</code>	Pointer to the driver device.
<code>pHW_API</code>	Pointer to a GUI_PORT_API structure. See required routines below.

#### Required GUI\_PORT\_API routines

Element	Data type
<code>pfWrite8_A0</code>	<code>void (*)(U8 Data)</code>
<code>pfWrite8_A1</code>	<code>void (*)(U8 Data)</code>
<code>pfWriteM8_A1</code>	<code>void (*)(U8 * pData, int NumItems)</code>
<code>pfRead8_A1</code>	<code>U8 (*)(void)</code>

### 13.7.17.6.3 GUIDRV\_SPage\_Set1502()

#### Description

Configures the driver to use one of the following controllers:

- Avant Electronics SBN0064G
- Hitachi HD61202
- Samsung S6B0108, KS0108

#### Prototype

```
void GUIDRV_SPage_Set1502(GUI_DEVICE * pDevice);
```

#### Parameters

Parameter	Description
<code>pDevice</code>	Pointer to the driver device.

### 13.7.17.6.4 GUIDRV\_SPage\_Set1510()

#### Description

Configures the driver to use one of the following controllers:

- Epson S1D15605, S1D15606, S1D15607, S1D15608, S1D15705, S1D15710, S1D15714
- Integrated Solutions Technology IST3020
- New Japan Radio Company NJU6676
- Novatek NT7502, NT7534, NT7538, NT75451
- Samsung S6B0713, S6B0719, S6B0724, S6B1713
- Sino Wealth SH1101A
- Sitronix ST7522, ST7565, ST7567, ST7570, ST7571
- Solomon SSD1303, SSD1305, SSD1306, SSD1309, SSD1805, SSD1815, SSD1821
- Sunplus SPLC501C
- UltraChip UC1601, UC1606, UC1608, UC1701

#### Prototype

```
void GUIDRV_SPage_Set1510(GUI_DEVICE * pDevice);
```

#### Parameters

Parameter	Description
<code>pDevice</code>	Pointer to the driver device.

### 13.7.17.6.5 GUIDRV\_SPage\_Set1512()

#### Description

Configures the driver to use one of the following controllers:

- Epson S1D15E05, S1D15E06, S1D15719, S1D15721

#### Prototype

```
void GUIDRV_SPage_Set1512(GUI_DEVICE * pDevice);
```

#### Parameters

Parameter	Description
<code>pDevice</code>	Pointer to the driver device.

### 13.7.17.6.6 GUIDRV\_SPage\_SetST75256()

#### Description

Configures the driver to use the Sitronix ST75256 controller.

#### Prototype

```
void GUIDRV_SPage_SetST75256(GUI_DEVICE * pDevice);
```

#### Parameters

Parameter	Description
<code>pDevice</code>	Pointer to the driver device.

### 13.7.17.6.7 GUIDRV\_SPage\_SetST75320()

#### Description

Configures the driver to use the Sitronix ST75320 controller.

#### Prototype

```
void GUIDRV_SPage_SetST75320(GUI_DEVICE * pDevice);
```

#### Parameters

Parameter	Description
<code>pDevice</code>	Pointer to the driver device.

### 13.7.17.6.8 GUIDRV\_SPage\_SetST7591()

#### Description

Configures the driver to use the Sitronix ST7591 controller.

#### Prototype

```
void GUIDRV_SPage_SetST7591(GUI_DEVICE * pDevice);
```

#### Parameters

Parameter	Description
<code>pDevice</code>	Pointer to the driver device.

### 13.7.17.6.9 GUIDRV\_SPage\_SetUC1610()

#### Description

Configures the driver use to the UltraChip UC1610 controller.

#### Prototype

```
void GUIDRV_SPage_SetUC1610(GUI_DEVICE * pDevice);
```

#### Parameters

Parameter	Description
<code>pDevice</code>	Pointer to the driver device.



### 13.7.17.6.10 GUIDRV\_SPage\_SetUC1611()

#### Description

Configures the driver use to the UltraChip UC1611 controller.

#### Prototype

```
void GUIDRV_SPage_SetUC1611(GUI_DEVICE * pDevice);
```

#### Parameters

Parameter	Description
<code>pDevice</code>	Pointer to the driver device.

### 13.7.17.6.11 GUIDRV\_SPage\_SetUC1628()

#### Description

Configures the driver use to the UltraChip UC1628 controller.

#### Prototype

```
void GUIDRV_SPage_SetUC1628(GUI_DEVICE * pDevice);
```

#### Parameters

Parameter	Description
<code>pDevice</code>	Pointer to the driver device.

### 13.7.17.6.12 GUIDRV\_SPage\_SetUC1638()

#### Description

Configures the driver use to the UltraChip UC1638 controller.

#### Prototype

```
void GUIDRV_SPage_SetUC1638(GUI_DEVICE * pDevice);
```

#### Parameters

Parameter	Description
<code>pDevice</code>	Pointer to the driver device.

### 13.7.17.7 Configuration Example

```
void LCD_X_Config(void) {
    GUI_PORT_API    PortAPI = {0};
    CONFIG_SPAGE    Config = {0};
    GUI_DEVICE      * pDevice;
    //
    // Set display driver and color conversion for 1st layer
    //
    pDevice = GUI_DEVICE_CreateAndLink(DISPLAY_DRIVER, COLOR_CONVERSION, 0, 0);
    //
    // Display size configuration
    //
    if (LCD_GetSwapXY()) {
        LCD_SetSizeEx (0, YSIZE_PHYS,  XSIZE_PHYS);
        LCD_SetVSizeEx(0, VYSIZE_PHYS, VXSIZE_PHYS);
    } else {
        LCD_SetSizeEx (0, XSIZE_PHYS,  YSIZE_PHYS);
        LCD_SetVSizeEx(0, VXSIZE_PHYS, VYSIZE_PHYS);
    }
    //
    // Driver configuration
    //
    Config.FirstSEG = 0;//256 - 224;
    GUIDRV_SPage_Config(pDevice, &Config);
    //
    // Configure hardware routines
    //
    PortAPI.pfWrite8_A0 = _Write8_A0;
    PortAPI.pfWrite8_A1 = _Write8_A1;
    PortAPI.pfWriteM8_A1 = _WriteM8_A1;
    PortAPI.pfReadM8_A1  = LCD_X_8080_8_ReadM01;
    GUIDRV_SPage_SetBus8(pDevice, &PortAPI);
    //
    // Controller configuration
    //
    GUIDRV_SPage_SetUC1611(pDevice);
}
```

## 13.7.18 GUIDRV\_SSD1322

### 13.7.18.1 Supported hardware

#### Controllers

The driver works with the following display controllers:

- Solomon SSD1322

#### Bits per pixel

The driver currently supports 4 bpp color depth.

#### Interfaces

The driver supports the indirect interface (8 bit) of the display controller.

### 13.7.18.2 Driver selection

To use GUIDRV\_SSD1322 for the given display, the following command can be used e.g.:

```
pDevice = GUI_DEVICE_CreateAndLink(GUIDRV_SSD1322, GUICC_4, 0, 0);
```

Detailed information about palette modes can be found in the chapter *Colors* on page 604.

### 13.7.18.3 Display data RAM organization

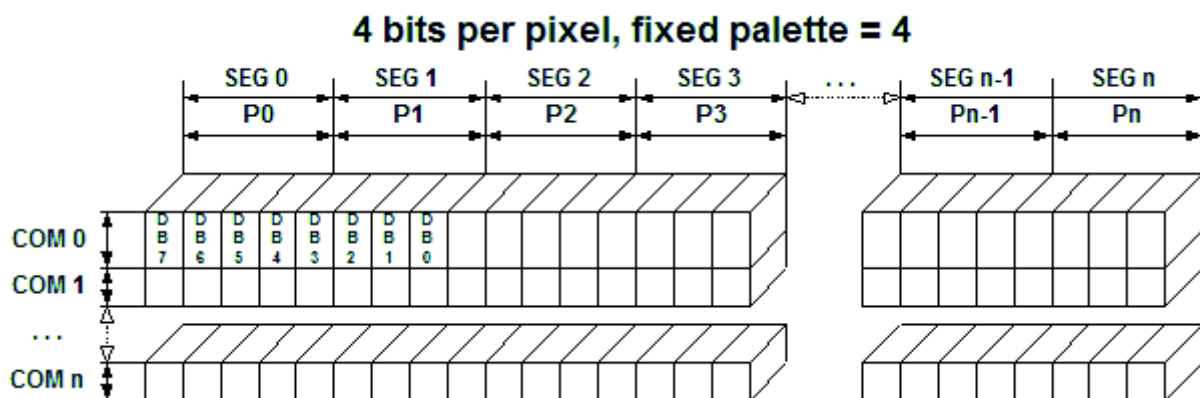

### 13.7.18.4 RAM requirements

This display driver requires a display data cache, containing a complete copy of the LCD data RAM. The amount of memory used by the cache may be calculated as follows:

```
Size of RAM (in bytes) = ((LCD_XSIZE + 1) / 2) \times LCD_YSIZE
```

### 13.7.18.5 Run-time configuration

The table below shows the available run-time configuration routines of this driver:

Routine	Description
<code>GUIDRV_SSD1322_Config()</code>	Passes a pointer to a <code>CONFIG_SSD1322</code> structure to the driver.
<code>GUIDRV_SSD1322_SetBus8()</code>	Tells the driver to use the 8 bit indirect interface and passes a pointer to a <code>GUI_PORT_API</code> structure to the driver containing function pointers to the hardware routines to be used.

### 13.7.18.5.1 GUIDRV\_SSD1322\_Config()

#### Description

Passes a pointer to a CONFIG\_SSD1322 structure to the driver.

#### Prototype

```
void GUIDRV_SSD1322_Config(GUI_DEVICE * pDevice,
                           CONFIG_SSD1322 * pConfig);
```

#### Parameters

Parameter	Description
<code>pDevice</code>	Pointer to the driver device.
<code>pConfig</code>	Pointer to a CONFIG_SSD1322 structure described below.

#### Elements of structure CONFIG\_SSD1322

Data type	Element	Description
int	FirstSEG	First segment address to be used in the data RAM of the display controller. The value can be determined experimentally or taken from the display documentation. The value is normally 0.
int	FirstCOM	First common address to be used in the data RAM of the display controller. The value can be determined experimentally or taken from the display documentation. The value is normally 0.

### 13.7.18.5.2 GUIDRV\_SSD1322\_SetBus8()

#### Description

Tells the driver to use the 8 bit indirect interface and passes a pointer to a GUI\_PORT\_API structure to the driver containing function pointers to the hardware routines to be used.

#### Prototype

```
void GUIDRV_SSD1322_SetBus8(GUI_DEVICE * pDevice,  
                             GUI_PORT_API * pHW_API);
```

#### Parameters

Parameter	Description
<a href="#">pDevice</a>	Pointer to the driver device.
<a href="#">pHW_API</a>	Pointer to a GUI_PORT_API structure. See required routines below.

### 13.7.18.6 Required GUI\_PORT\_API routines

Data type	Element	Description
<code>void (*)(U8 Data);</code>	<code>pfWrite8_A0</code>	Pointer to a function which writes one byte to the controller with C/D line low.
<code>void (*)(U8 Data);</code>	<code>pfWrite8_A1</code>	Pointer to a function which writes one byte to the controller with C/D line high.
<code>void (*)(U8 * pData, int NumItems);</code>	<code>pfWriteM8_A1</code>	Pointer to a function which writes multiple bytes to the controller with C/D line high.
<code>U8 (*)(void);</code>	<code>pfRead8_A1</code>	Pointer to a function which reads one byte from the controller with C/D line high.
<code>void (*)(U8 * pData, int NumItems);</code>	<code>pfReadM8_A1</code>	Pointer to a function which reads multiple bytes from the controller with C/D line high.

### 13.7.18.7 Configuration example

```

void LCD_X_Config(void) {
    CONFIG_SSD1322    Config = {0};
    GUI_DEVICE        * pDevice;
    GUI_PORT_API      PortAPI = {0};
    //
    // Set display driver and color conversion for 1st layer
    //
    pDevice = GUI_DEVICE_CreateAndLink(DISPLAY_DRIVER, COLOR_CONVERSION, 0, 0);
    //
    // Display size configuration
    //
    if (LCD_GetSwapXY()) {
        LCD_SetSizeEx (0, YSIZE_PHYS,    XSIZE_PHYS);
        LCD_SetVSizeEx(0, VYSIZE_PHYS,   VXSIZE_PHYS);
    } else {
        LCD_SetSizeEx (0, XSIZE_PHYS,    YSIZE_PHYS);
        LCD_SetVSizeEx(0, VXSIZE_PHYS,   VYSIZE_PHYS);
    }
    //
    // Driver configuration
    //
    Config.FirstSEG = 112;
    GUIDRV_SSD1322_Config(pDevice, &Config);
    //
    // Configure hardware routines
    //
    PortAPI.pfWrite8_A0 = LCD_X_SPI4_Write0;
    PortAPI.pfWrite8_A1 = LCD_X_SPI4_Write1;
    PortAPI.pfWriteM8_A1 = LCD_X_SPI4_WriteM1;
    PortAPI.pfRead8_A1 = LCD_X_SPI4_Read1;
    PortAPI.pfReadM8_A1 = LCD_X_SPI4_ReadM1;
    GUIDRV_SSD1322_SetBus8(pDevice, &PortAPI);
}

```



## 13.7.19 GUIDRV\_SSD1926

### 13.7.19.1 Supported hardware

#### Controllers

This driver works with the Solomon SSD1926 display controller.

#### Bits per pixel

Currently supported color depth is 8. The display controller supports up to 32 bits per pixel. The driver can be extended on demand if support for an other color depth is required.

#### Interfaces

The driver supports the 16 bit indirect interface.

### 13.7.19.2 Color depth and display orientation

This driver can be used with different orientations. The following table shows the configuration macros which can be used to create and link the driver during the initialization:

Identifier	Color depth and orientation
GUIDRV_SSD1926_8	8bpp, default orientation
GUIDRV_SSD1926_OY_8	8bpp, Y axis mirrored
GUIDRV_SSD1926_OX_8	8bpp, X axis mirrored
GUIDRV_SSD1926_OXY_8	8bpp, X and Y axis mirrored
GUIDRV_SSD1926_OS_8	8bpp, X and Y swapped
GUIDRV_SSD1926_OSY_8	8bpp, X and Y swapped, Y axis mirrored
GUIDRV_SSD1926_OSX_8	8bpp, X and Y swapped, X axis mirrored
GUIDRV_SSD1926_OSXY_8	8bpp, X and Y swapped, X and Y axis mirrored

### 13.7.19.3 Driver selection

To use GUIDRV\_SSD1926 for the given display, the following command can be used e.g.:

```
pDevice = GUI_DEVICE_CreateAndLink(GUIDRV_SSD1926, GUICC_323, 0, 0);
```

Detailed information about palette modes can be found in the chapter *Colors* on page 604.

### 13.7.19.4 Display data RAM organization

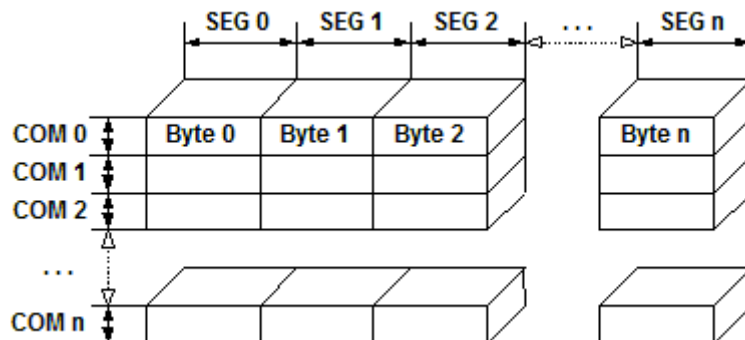

The picture above shows the relation between the display memory and the SEG and COM lines of the display.

### 13.7.19.5 RAM requirements

This display driver may be used with or without a display data cache, containing a complete copy of the LCD data RAM. If no cache is used, there are no additional RAM requirements. It is recommended to use this driver with a data cache for faster LCD-access. The amount of memory used by the cache may be calculated as follows:

```
Size of RAM (in bytes) = LCD_XSIZE \times LCD_YSIZE
```

### 13.7.19.6 Run-time configuration

The table below shows the available run-time configuration routines of this driver:

Routine	Description
<code>GUIDRV_SSD1926_Config()</code>	Passes a pointer to a <code>CONFIG_SSD1926</code> structure to the driver.
<code>GUIDRV_SSD1926_SetBus16()</code>	Tells the driver to use the 16 bit indirect interface and passes a pointer to a <code>GUI_PORT_API</code> structure to the driver containing function pointers to the hardware routines to be used.

### 13.7.19.6.1 GUIDRV\_SSD1926\_Config()

#### Description

Passes a pointer to a CONFIG\_SSD1926 structure to the driver.

#### Prototype

```
void GUIDRV_SSD1926_Config(GUI_DEVICE * pDevice,
                           CONFIG_SSD1926 * pConfig);
```

#### Parameters

Parameter	Description
<code>pDevice</code>	Pointer to the driver device.
<code>pConfig</code>	Pointer to a CONFIG_SSD1926 structure described below.

#### Elements of structure CONFIG\_SSD1926

Data type	Element	Description
int	FirstSEG	First segment address to be used in the data RAM of the display controller. The value can be determined experimentally or taken from the display documentation. The value is normally 0.
int	FirstCOM	First common address to be used in the data RAM of the display controller. The value can be determined experimentally or taken from the display documentation. The value is normally 0.
int	UseCache	Enables or disables use of a data cache. Should be set to 1 for enabling and to 0 for disabling.

### 13.7.19.6.2 GUIDRV\_SSD1926\_SetBus16()

#### Description

Tells the driver to use the 16 bit indirect interface and passes a pointer to a GUI\_PORT\_API structure to the driver containing function pointers to the hardware routines to be used.

#### Prototype

```
void GUIDRV_SSD1926_SetBus16(GUI_DEVICE * pDevice,
                             GUI_PORT_API * pHW_API);
```

#### Parameters

Parameter	Description
<code>pDevice</code>	Pointer to the driver device.
<code>pHW_API</code>	Pointer to a GUI_PORT_API structure. See required routines below.

### 13.7.19.7 Required GUI\_PORT\_API routines

Data type	Element	Description
<code>void (*)(U16 Data)</code>	<code>pfWrite16_A0</code>	Pointer to a function which writes one word to the controller with C/D line low.
<code>void (*)(U16 Data)</code>	<code>pfWrite16_A1</code>	Pointer to a function which writes one word to the controller with C/D line high.
<code>void (*)(U16 * pData, int NumItems)</code>	<code>pfWriteM16_A0</code>	Pointer to a function which writes multiple words to the controller with C/D line low.
<code>void (*)(U16 * pData, int NumItems)</code>	<code>pfWriteM16_A1</code>	Pointer to a function which writes multiple words to the controller with C/D line high.
<code>U16 (*)(void)</code>	<code>pfRead16_A1</code>	Pointer to a function which reads one word from the controller with C/D line high.

### 13.7.19.8 Configuration Example

```
#define XSIZE 320L
#define YSIZE 240L
GUI_PORT_API _PortAPI;
void LCD_X_Config(void) {
    GUI_DEVICE * pDevice_0;
    CONFIG_SSD1926 Config_0 = {0};
    //
    // Set display driver and color conversion
    //
    pDevice_0 = GUI_DEVICE_CreateAndLink(GUIDRV_SSD1926_8, GUICC_8666, 0, 0);
    //
    // Common display driver configuration
    //
    LCD_SetSizeEx (0, XSIZE, YSIZE);
    LCD_SetVSizeEx(0, XSIZE, YSIZE);
    //
    // Set driver specific configuration items
    //
    Config_0.UseCache = 1;
    //
    // Set hardware access routines
    //
    _PortAPI.pfWrite16_A0 = LCD_X_8080_16_Write00_16;
    _PortAPI.pfWrite16_A1 = LCD_X_8080_16_Write01_16;
    _PortAPI.pfWriteM16_A0 = LCD_X_8080_16_WriteM00_16;
    _PortAPI.pfWriteM16_A1 = LCD_X_8080_16_WriteM01_16;
```

```
_PortAPI.pfRead16_A1 = LCD_X_8080_16_Read01_16;  
GUIDRV_SSD1926_SetBus16(pDevice, &_PortAPI);  
//  
// Pass configuration structure to driver  
//  
GUIDRV_SSD1926_Config(pDevice, &Config_0);  
}
```

## 13.7.20 GUIDRV\_UC1698G

### 13.7.20.1 Supported Hardware

#### Controllers

This driver has been tested with the UltraChip UC1698G.

#### Bits per pixel

5 bpp grayscales.

#### Interfaces

The driver supports the 8- and 16-bit indirect interface.

### 13.7.20.2 Color depth and display orientation

The driver consists of several files. They are named `_[O]_[BPP]C[CACHE].c`. The `[O]` is optional and stands for the desired display orientation. `[BPP]` means the color depth to use and `[CACHE]` is defined with 1 to use a cache and 0 to work without cache. The following table shows the driver files and the configuration macros which should be used to create and link the driver during the initialization:

Identifier	Color depth and orientation
GUIDRV_UC1698G_5C0	5bpp, no cache, default orientation.
GUIDRV_UC1698G_OY_5C0	5bpp, no cache, Y axis mirrored.
GUIDRV_UC1698G_OX_5C0	5bpp, no cache, X axis mirrored.
GUIDRV_UC1698G_OXY_5C0	5bpp, no cache, Y and X axis mirrored.
GUIDRV_UC1698G_OS_5C0	5bpp, no cache, X and Y axis swapped.
GUIDRV_UC1698G_OSY_5C0	5bpp, no cache, Y axis mirrored, X and Y axis swapped.
GUIDRV_UC1698G_OSX_5C0	5bpp, no cache, X axis mirrored, X and Y axis swapped.
GUIDRV_UC1698G_OSXY_5C0	5bpp, no cache, X and Y axis mirrored, X and Y axis swapped.
GUIDRV_UC1698G_5C1	5bpp, cache, default orientation.
GUIDRV_UC1698G_OY_5C1	5bpp, cache, Y axis mirrored.
GUIDRV_UC1698G_OX_5C1	5bpp, cache, X axis mirrored.
GUIDRV_UC1698G_OXY_5C1	5bpp, cache, Y and X axis mirrored.
GUIDRV_UC1698G_OS_5C1	5bpp, cache, X and Y axis swapped.
GUIDRV_UC1698G_OSY_5C1	5bpp, cache, Y axis mirrored, X and Y axis swapped.
GUIDRV_UC1698G_OSX_5C1	5bpp, cache, X axis mirrored, X and Y axis swapped.
GUIDRV_UC1698G_OSXY_5C1	5bpp, cache, X and Y axis mirrored, X and Y axis swapped.

### 13.7.20.3 Driver selection

To use for the given display, the following command can be used e.g.:

```
pDevice = GUI_DEVICE_CreateAndLink(GUIDRV_UC1698G_5C1, GUICC_5, 0, 0);
```

Detailed information about palette modes can be found in the chapter *Colors* on page 604.

### 13.7.20.4 Display data RAM organization

#### 5 bits per pixel, grayscale

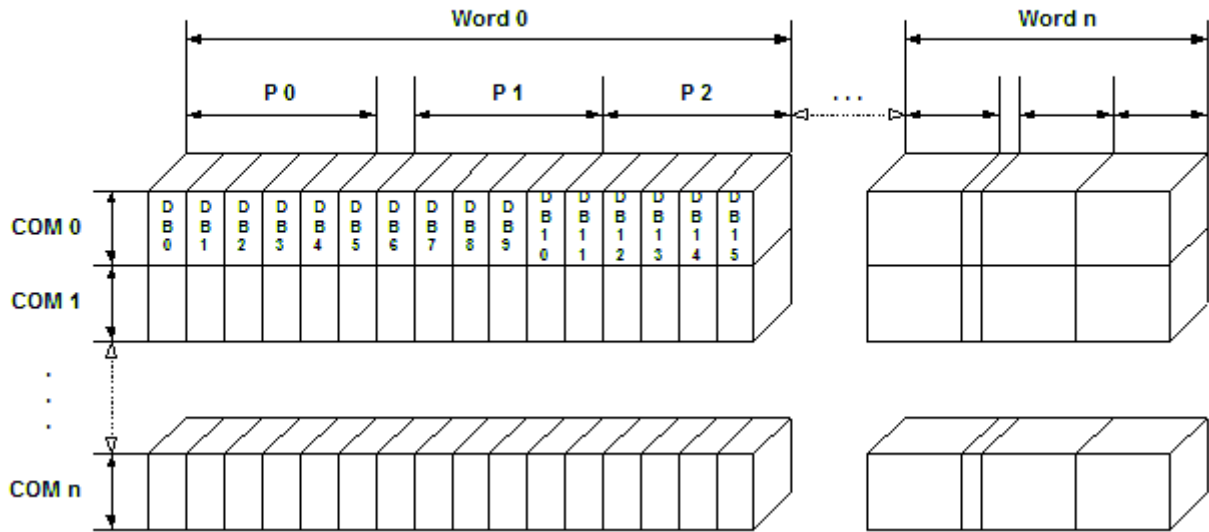

The picture above shows the relation between the display memory and the pixels of the LCD in terms of the color depth.

### 13.7.20.5 RAM requirements

This display driver requires approx. 500 Bytes to work. It can also be used with and without a display data cache, containing a complete copy of the content of the display data RAM. The amount of memory used by the cache is:

$$(LCD\_XSIZE + 2) / 3 * LCD\_YSIZE * 2$$

Using a cache avoids reading operations from the display controller in case of XOR drawing operations and further it speeds up string output operations.

### 13.7.20.6 Run-time configuration

The table below shows the available run-time configuration routines of this driver:

Routine	Description
<code>GUIDRV_UC1698G_Config()</code>	Passes a pointer to a <code>CONFIG_UC1698G</code> structure to the driver.
<code>GUIDRV_UC1698G_SetBus8()</code>	Tells the driver to use the 8 bit indirect interface and passes pointer to a <code>GUI_PORT_API</code> structure to the driver.
<code>GUIDRV_UC1698G_SetBus16()</code>	Tells the driver to use the 16 bit indirect interface and passes pointer to a <code>GUI_PORT_API</code> structure to the driver.

### 13.7.20.6.1 GUIDRV\_UC1698G\_Config()

#### Description

Configures the driver to work according to the passed CONFIG\_UC1698G structure.

#### Prototype

```
void GUIDRV_UC1698G_Config(GUI_DEVICE * pDevice,
                           CONFIG_UC1698G * pConfig);
```

#### Parameters

Parameter	Description
<code>pDevice</code>	Pointer to the driver device.
<code>pConfig</code>	Pointer to a CONFIG_UC1698G structure described below.

#### Elements of structure CONFIG\_UC1698G

Data type	Element	Description
int	FirstSEG	First segment address to be used in the data RAM of the display controller. The value can be determined experimentally or taken from the display documentation. The value is normally 0.
int	FirstCOM	First common address to be used in the data RAM of the display controller. The value can be determined experimentally or taken from the display documentation. The value is normally 0.
int	NumDummyReads	Number of dummy reads to do before the actual read operation.



### 13.7.20.6.2 GUIDRV\_UC1698G\_SetBus8()

#### Description

Tells the driver to use the 8 bit indirect interface and passes a pointer to a GUI\_PORT\_API structure to the driver containing function pointers to the hardware routines to be used.

#### Prototype

```
void GUIDRV_UC1698G_SetBus8(GUI_DEVICE * pDevice,  
                             GUI_PORT_API * pHW_API);
```

#### Parameters

Parameter	Description
<code>pDevice</code>	Pointer to the driver device.
<code>pHW_API</code>	Pointer to a GUI_PORT_API structure. The required routines are listed below.

### 13.7.20.6.3 GUIDRV\_UC1698G\_SetBus16()

#### Description

Tells the driver to use the 16 bit indirect interface and passes a pointer to a GUI\_PORT\_API structure to the driver containing function pointers to the hardware routines to be used.

#### Prototype

```
void GUIDRV_UC1698G_SetBus16(GUI_DEVICE * pDevice,  
                             GUI_PORT_API * pHW_API);
```

#### Parameters

Parameter	Description
<a href="#">pDevice</a>	Pointer to the driver device.
<a href="#">pHW_API</a>	Pointer to a GUI_PORT_API structure. The required routines are listed below.

### 13.7.20.7 Required GUI\_PORT\_API routines

The required GUI\_PORT\_API routines depend on the used interface. If a cache is used the routines for reading data are unnecessary for each interface:

#### 8 bit interface

Data type	Element	Description
<code>void (*)(U8 Data);</code>	<a href="#">pfWrite8_A0</a>	Pointer to a function which writes one byte to the controller with C/D line low.
<code>void (*)(U8 Data);</code>	<a href="#">pfWrite8_A1</a>	Pointer to a function which writes one byte to the controller with C/D line high.
<code>void (*)(U8 * pData, int NumItems);</code>	<a href="#">pfWriteM8_A0</a>	Pointer to a function which writes multiple bytes to the controller with C/D line low.
<code>void (*)(U8 * pData, int NumItems);</code>	<a href="#">pfWriteM8_A1</a>	Pointer to a function which writes multiple bytes to the controller with C/D line high.
<code>U8 (*)(void);</code>	<a href="#">pfRead8_A0</a>	Pointer to a function which reads one byte from the controller with C/D line low.
<code>U8 (*)(void);</code>	<a href="#">pfRead8_A1</a>	Pointer to a function which reads one byte from the controller with C/D line high.
<code>void (*)(U8 * pData, int NumItems);</code>	<a href="#">pfReadM8_A1</a>	Pointer to a function which reads multiple bytes from the controller with C/D line high.

#### 16 bit interface

Data type	Element	Description
<code>void (*)(U16 Data);</code>	<a href="#">pfWrite16_A0</a>	Pointer to a function which writes one word to the controller with C/D line low.
<code>void (*)(U16 Data);</code>	<a href="#">pfWrite16_A1</a>	Pointer to a function which writes one word to the controller with C/D line high.
<code>void (*)(U16 * pData, int NumItems);</code>	<a href="#">pfWriteM16_A0</a>	Pointer to a function which writes multiple words to the controller with C/D line low.
<code>void (*)(U16 * pData, int NumItems);</code>	<a href="#">pfWriteM16_A1</a>	Pointer to a function which writes multiple words to the controller with C/D line high.
<code>U16 (*)(void);</code>	<a href="#">pfRead16_A0</a>	Pointer to a function which reads one word from the controller with C/D line low.
<code>U16 (*)(void);</code>	<a href="#">pfRead16_A1</a>	Pointer to a function which reads one word from the controller with C/D line high.
<code>void (*)(U16 * pData, int NumItems);</code>	<a href="#">pfReadM16_A1</a>	Pointer to a function which reads multiple words from the controller with C/D line high.

## 13.7.21 GUIDRV\_CompactColor\_16

### 13.7.21.1 Supported Hardware

#### Controllers

This driver works with the following display controllers:

- Ampire FSA506
- Epson S1D13742, S1D13743, S1D19122
- FocalTech FT1509
- Himax HX8301, HX8312A, HX8325A, HX8340, HX8347, HX8352, HX8352B, HX8353
- Hitachi HD66766, HD66772, HD66789
- Ilitek ILI9161, ILI9220, ILI9221, ILI9320, ILI9325, ILI9326, ILI9328, ILI9342, ILI9481
- LG Electronics LGDP4531, LGDP4551
- MagnaChip D54E4PA7551
- Novatek NT39122, NT7573
- OriseTech SPFD5408, SPFD54124C, SPFD5414D, SPFD5420A
- Renesas R61505, R61509, R61516, R61526, R61580, R63401
- Samsung S6D0110A, S6D0117, S6D0128, S6D0129, S6D04H0
- Sharp LCY-A06003, LR38825
- Sitronix ST7628, ST7637, ST7687, ST7712, ST7715, ST7735, ST7787, ST7789
- Solomon SSD1284, SSD1289, SSD1298, SSD1355, SSD1961, SSD1963, SSD2119
- Toshiba JBT6K71

#### Bits per pixel

Supported color depth is 16 bpp.

#### Interfaces

The driver supports the indirect interface (8- and 16-bit) and the 3 pin SPI interface. Default mode is 8-bit indirect.

### 13.7.21.2 Driver selection and configuration

To be able to use this driver the following macro definition needs to be added to the configuration file `LCDCConf.h`:

```
#define LCD_USE_COMPACT_COLOR_16
```

After this define has been added the display driver assumes the driver specific configuration file `LCDCConf_CompactColor_16.h` in the configuration folder. All further compile time configuration macros should be defined in this file. To create a driver device using the `GUI-DRV_CompactColor_16` for the given display, e.g. the following command can be used:

```
pDevice = GUI_DEVICE_CreateAndLink(GUIDRV_COMPACT_COLOR_16, GUICC_565, 0, 0);
```

Detailed information about palette modes can be found in the chapter *Colors* on page 604.

### 13.7.21.3 Display data RAM organization

#### 16 bits per pixel, fixed palette = 565

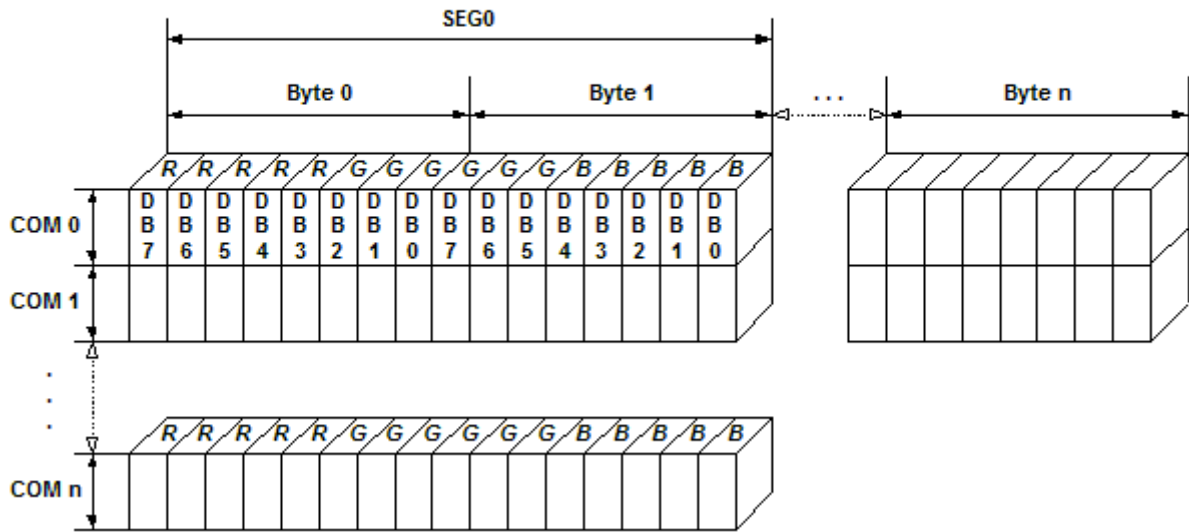

The picture above shows the relation between the display memory and the SEG and COM lines of the display.

### 13.7.21.4 RAM requirements

This display driver can be used with and without a display data cache, containing a complete copy of the contents of the display data RAM. The amount of memory used by the cache is:

```
LCD_XSIZE \times LCD_YSIZE \times 2 bytes
```

Using a cache is only recommended if it is intended to use a lot of drawing operations using the XOR drawing mode. A cache would avoid reading the display data in this case. Normally the use of a cache is not recommended.

The driver uses a write buffer for drawing multiple pixels of the same color. If multiple pixels of the same color should be drawn, the driver first fills the buffer and then performs a single call of the `LCD_WRITEITEM_A1` macro to transfer the data to the display controller at once. The default buffer size is 500 bytes.

### 13.7.21.5 Compile-time configuration

#### Controller selection

To select the desired controller the macro `LCD_CONTROLLER` should be used in the configuration file `LCDConf_CompactColor_16.h`. The following table shows the values to be used to select the appropriate controller:

Number	Supported controller
66700	Sharp LR38825
66701	<ul style="list-style-type: none"> <li>Ilitek ILI9326</li> <li>OriseTech SPFD5420A</li> <li>Renesas R61509, R63401</li> </ul>
66702	Solomon SSD1284, SSD1289, SSD1298
66703	Toshiba JBT6K71
66704	Sharp LCY-A06003
66705	Samsung S6D0129

Number	Supported controller
66706	MagnaChip D54E4PA7551
66707	Himax HX8312
66708	<ul style="list-style-type: none"> <li>FocalTech FT1509</li> <li>Ilitek ILI9320, ILI9325, ILI9328</li> <li>LG Electronics LGDP4531, LGDP4551</li> <li>OriseTech SPFD5408</li> <li>Renesas R61505, R61580</li> </ul>
66709	<ul style="list-style-type: none"> <li>Epson S1D19122</li> <li>Himax HX8353</li> <li>Ilitek ILI9342, ILI9481</li> <li>Novatek NT39122</li> <li>Orisetech SPFD54124C, SPFD5414D</li> <li>Renesas R61516, R61526</li> <li>Samsung S6D04H0</li> <li>Sitronix ST7628, ST7637, ST7687, ST7715, ST7735</li> <li>Solomon SSD1355, SSD1961, SSD1963</li> </ul>
66710	Novatek NT7573
66711	Epson S1D13742, S1D13743
66712	Himax HX8347, HX8352
66713	Himax HX8340
66714	Solomon SSD2119
66715	Himax HX8352B
66716	Ampire FSA506
66717	Sitronix ST7787, ST7789
66766	<ul style="list-style-type: none"> <li>Hitachi HD66766</li> <li>Ilitek ILI9161</li> <li>Samsung S6D0110A</li> </ul>
66772	<ul style="list-style-type: none"> <li>Himax HX8301</li> <li>Hitachi HD66772</li> <li>Ilitek ILI9220, ILI9221</li> <li>Samsung S6D0117, S6D0128</li> <li>Sitronix ST7712</li> </ul>
66789	Hitachi HD66789

## Display configuration

The following table shows the available configuration macros:

Macro	Description
<a href="#">LCD_MIRROR_X</a>	Activate to mirror X-axis.
<a href="#">LCD_MIRROR_Y</a>	Activate to mirror Y-axis.
<a href="#">LCD_SWAP_XY</a>	Activate to swap X- and Y-axis.

For details, refer to *Display orientation* on page 3266.

## Hardware access

The following table shows the available configuration macros which can be defined in this file for configuring the hardware access:

Macro	Description
<a href="#">LCD_NUM_DUMMY_READS</a>	Number of required dummy reads if a read operation should be executed. The default value is 2. If using a serial interface the display controllers

Macro	Description
	HD66766 and HD66772 need 5 dummy reads. Sharp LR38825 needs 3 dummy reads with a 8-bit bus.
LCD_REG01	This macro is only required if a Himax HX8312A is used. Unfortunately the register 0x01 (Control register 1) contains orientation specific settings as well as common settings. So this macro should contain the contents of this register.
LCD_SERIAL_ID	With a serial 3 wire interface this macro defines the ID signal of the device ID code. It should be 0 (default) or 1. <b>Please note:</b> This macro is only used with the 3 wire protocol for Hitachi HD66772, Samsung S6D0117, Himax HX8301 and Ilitek ILI9220.
LCD_USE_SERIAL_3PIN	This configuration macro has been implemented to support the 3 wire serial interface of the following controllers: Hitachi HD66772, Samsung S6D0117, Himax HX8301, Ilitek ILI9220. Should be set to 1 if the 3 wire serial interface is used. Default is 0. <b>Please note:</b> Do not use this macro with other display controllers!
LCD_USE_PARALLEL_16	Should be set to 1 if the 16 bit parallel interface is used. Default is 0.
LCD_WRITE_BUFFER_SIZE	Defines the size of the write buffer. Using a write buffer increases the performance of the driver. If multiple pixels should be written with the same color, the driver first fills the buffer and then writes the content of the buffer using LCD_WRITEM_A1 instead of multiple calls of LCD_WRITE_A1. The default buffer size is 500 bytes.
LCD_WRITE_A0	Write a byte to display controller with RS-line low.
LCD_WRITE_A1	Write a byte to display controller with RS-line high.
LCD_READM_A1	Read multiple bytes (8 bit parallel interface) or multiple words (16 bit parallel interface) from display controller with RS-line high.
LCD_WRITEM_A1	Write multiple bytes (8 bit parallel interface) or multiple words (16 bit parallel interface) to display controller with RS-line high.
LCD_WRITEM_A0	Write multiple bytes (8 bit parallel interface) or multiple words (16 bit parallel interface) to display controller with RS-line low.

The 'Driver Output Mode' and 'Entry Mode' registers are initialized automatically.

### 13.7.21.6 Additional configuration switches

The following table shows optional configuration switches available for this driver:

Macro	Description
LCD_CACHE	When set to 0, no display data cache is used, which slows down the speed of the driver. Default is 1 (cache activated).
LCD_FIRSTCOM0	This macro can be used to define the first common address to be used in the data RAM of the display controller. The value can be determined experimentally or taken from the display doc.
LCD_FIRSTSEG0	This macro can be used to define the first segment address to be used in the data RAM of the display controller. The value can be determined experimentally or taken from the display doc.
LCD_SUPPORT_CACHECONTROL	When set to 1, LCD_ControlCache() can be used.

### 13.7.21.7 Configuration example

The following shows how to select the driver and how it can be configured:

#### LCDCConf.h

As explained above it should include the following for selecting the driver:

```
#define LCD_USE_COMPACT_COLOR_16
```

## LCDCConf\_CompactColor\_16.h

This file contains the display driver specific configuration and could look as the following:

```
//
// General configuration of LCD
//
#define LCD_CONTROLLER      66709 // Renesas R61516
#define LCD_BITSPERPIXEL   16
#define LCD_USE_PARALLEL_16 1
#define LCD_MIRROR_Y       1
//
// Indirect interface configuration
//
void LCD_X_Write01_16(unsigned short c);
void LCD_X_Write00_16(unsigned short c);
void LCD_X_WriteM01_16(unsigned short * pData, int NumWords);
void LCD_X_WriteM00_16(unsigned short * pData, int NumWords);
void LCD_X_ReadM01_16 (unsigned short * pData, int NumWords);
#define LCD_WRITE_A1(Word) LCD_X_Write01_16(Word)
#define LCD_WRITE_A0(Word) LCD_X_Write00_16(Word)
#define LCD_WRITEM_A1(Word, NumWords) LCD_X_WriteM01_16(Word, NumWords)
#define LCD_WRITEM_A0(Word, NumWords) LCD_X_WriteM00_16(Word, NumWords)
#define LCD_READM_A1(Word, NumWords) LCD_X_ReadM01_16(Word, NumWords)
```

## LCDCConf.c

The following shows how to create a display driver device with this driver and how to configure it:

```
void LCD_X_Config(void) {
    //
    // Set display driver and color conversion
    //
    GUI_DEVICE_CreateAndLink(GUIDRV_COMPACT_COLOR_16, // Display driver
                             GUICC_M565,             // Color conversion
                             0, 0);

    //
    // Display driver configuration
    //
    LCD_SetSizeEx(0, 240, 320);
    // Physical display size in pixels
}
}
```



## 13.7.22 GUIDRV\_Fujitsu\_16

This driver supports the Fujitsu Graphic display controllers. It has been tested with "Jasmine", but it should also work with "Lavender", since all relevant registers are compatible.

### 13.7.22.1 Supported hardware

#### Controllers

This driver works with the following display controllers:

- Fujitsu Jasmine
- Fujitsu Lavender

#### Bits per pixel

Supported color depths are 1, 2, 4, 8 and 16 bpp.

#### Interfaces

The driver has been tested with a 32 bit interface to the CPU. If a 16 bit interface is used, the 32-bit accesses can be replaced by 2 16-bit accesses.

### 13.7.22.2 Driver selection and configuration

To be able to use this driver the following macro definition needs to be added to the configuration file `LCDConf.h`:

```
#define LCD_USE_FUJITSU_16
```

After this define has been added the display driver assumes the driver specific configuration file `LCDConf_Fujitsu_16.h` in the configuration folder. All further compile time configuration macros should be defined in this file. To create a driver device using the `GUIDRV_Fujitsu_16` for the given display, e.g. the following command can be used:

```
pDevice = GUI_DEVICE_CreateAndLink(GUIDRV_FUJITSU_16, GUICC_556, 0, 0);
```

Detailed information about palette modes can be found in the chapter *Colors* on page 604.

### 13.7.22.3 Available configuration macros (compile time configuration)

#### Controller selection

To select the desired controller the macro `LCD_CONTROLLER` should be used in the configuration file `LCDConf_Fujitsu_16.h`. The following table shows the values to be used to select the appropriate controller:

Number	Supported controller
8720	Fujitsu Jasmine
8721	Fujitsu Lavender

### 13.7.22.4 Display data RAM organization

The display controller uses DRAM in an optimized, non-linear way (described in the Fujitsu documentation). Direct memory access is not used by the driver.

### 13.7.22.5 RAM requirements

About 16 bytes for some static variables.

### 13.7.22.6 Hardware configuration

This driver requires a direct interface for hardware access as described in the chapter *Configuration* on page 109. The following table lists the macros which must be defined for hardware access:

Macro	Description
<code>LCD_READ_REG</code>	Read a register of the display controller. (as 32 bit value) (optional)
<code>LCD_WRITE_REG</code>	Write a register of the display controller. (as 32 bit value) (optional)

The driver contains a default for hardware access macros, which configures 32 bit access on the Fujitsu demonstration platform (Using an MB91361 or MB91362 and a Jasmine chip at address `0x30000000`); if the target hardware is compatible with these settings, then `LCD_READ_REG()`, `LCD_WRITE_REG()` do not need to be defined.

#### Color format (R/B swap)

It seems that on some target systems, Red and blue are swapped. This can be changed via software if the `config` switch `LCD_SWAP_RB` is toggled in the configuration file.

#### Hardware initialization

The display controller requires a complicated initialization. Example code is available from Fujitsu in the GDC module. This code is not part of the driver, since it depends on the actual chip used, on the clock settings, the display and a lot of other things. We recommend using the original Fujitsu code, since the documentation of the chips is not sufficient to write this code. Before calling `GUI_Init()`, the GDC should be initialized using this code (typically called as `GDC_Init(0xff)`).

#### Example

`LCDCnf.h` for VGA display, 8bpp, Jasmine:

```
#define LCD_XSIZE      640 // X-resolution of LCD, Logical color
#define LCD_YSIZE      480 // Y-resolution of LCD, Logical color
#define LCD_BITSPERPIXEL  8
#define LCD_CONTROLLER 8720 // Jasmine
```

### 13.7.22.7 Additional configuration switches

The following table shows optional configuration macros available for this driver:

Macro	Description
<code>LCD_ON</code>	Function replacement macro which switches the display on.
<code>LCD_OFF</code>	Function replacement macro which switches the display off.

## 13.7.23 GUIDRV\_Page1bpp

### 13.7.23.1 Supported hardware

#### Controllers

This driver works with the following display controllers:

- Epson S1D10605, S1D15605, S1D15705, S1D15710, S1D15714, S1D15721, S1D15E05, S1D15E06, SED1520, SED1560, SED1565, SED1566, SED1567, SED1568, SED1569, SED1575
- Hitachi HD61202
- Integrated Solutions Technology IST3020
- New Japan Radio Company NJU6676, NJU6679
- Novatek NT7502, NT7534, NT7538, NT75451
- Philips PCF8810, PCF8811, PCF8535, PCD8544
- Samsung KS0108B, KS0713, KS0724, S6B0108B, S6B0713, S6B0719, S6B0724, S6B1713
- Sino Wealth SH1101A
- Sitronix ST7522, ST7565, ST7567
- Solomon SSD1303, SSD1805, SSD1815, SSD1821
- ST Microelectronics ST7548, STE2001, STE2002
- Sunplus SPLC501C
- UltraChip UC1601, UC1606, UC1608, UC1701

It should be assumed that it will also work with every similar organized controller.

#### Bits per pixel

Supported color depth is 1bpp.

#### Interfaces

The driver supports the indirect interface (8 bit) of the display controller. Parallel, 4-pin SPI or I2C bus can be used.

### 13.7.23.2 Driver selection and configuration

To be able to use this driver the following macro definition needs to be added to the configuration file `LCDCConf.h`:

```
#define LCD_USE_PAGE1BPP
```

After this define has been added the display driver assumes the driver specific configuration file `LCDCConf_Page1bpp.h` in the configuration folder. All further compile time configuration macros should be defined in this file. To create a driver device using the `GUIDRV_Page1bpp` for the given display, e.g. the following command can be used:

```
pDevice = GUI_DEVICE_CreateAndLink(GUIDRV_PAGE1BPP, GUICC_1, 0, 0);
```

Detailed information about palette modes can be found in the chapter *Colors* on page 604.

### 13.7.23.3 Compile-time configuration

#### Controller selection

To select the desired controller the macro `LCD_CONTROLLER` should be used in the configuration file `LCDCConf_Page1bpp.h`. The following table shows the values to be used to select the appropriate controller:

Number	Supported controller
1501	• Samsung KS0713, KS0724, S6B0713, S6B0724

Number	Supported controller
	<ul style="list-style-type: none"> <li>UltraChip UC1601, UC1606</li> </ul>
1502	Samsung KS0108B S6B0108B
1503	Hitachi HD61202
1504	Philips PCF8810, PCF8811
1505	Philips PCF8535
1506	New Japan Radio Company NJU6679
1507	Philips PCD8544
1508	Epson S1D15710
1509	Solomon SSD1303 OLED controller
1510	<ul style="list-style-type: none"> <li>Epson S1D15714</li> <li>Integrated Solutions Technology IST3020</li> <li>New Japan Radio Company NJU6676</li> <li>Novatek NT7538, NT75451</li> <li>Samsung S6B0719</li> <li>Sino Wealth SH1101A</li> <li>Sitronix ST7522, ST7565, ST7567</li> <li>Solomon SSD1805, SSD1821</li> <li>UltraChip UC1608, UC1701</li> </ul>
1511	Epson S1D15721
1512	Epson S1D15E05, S1D15E06
1513	ST Microelectronics ST7548, STE2001, STE2002
1520	Epson SED1520
1560	Epson SED1560
1565	<ul style="list-style-type: none"> <li>Epson SED1565, S1D10605, S1D15605</li> <li>Novatek NT7502, NT7534</li> <li>Samsung S6B1713</li> <li>Solomon SSD1815</li> <li>Sunplus SPLC501C</li> </ul>
1566	Epson SED1566
1567	Epson SED1567
1568	Epson SED1568
1569	Epson SED1569
1575	Epson SED1575, S1D15705

### 13.7.23.4 RAM requirements

This display driver can be used with or without a display data cache in the most cases. If one display contains more than 1 display controller you can not disable the cache. The data cache contains a complete copy of the contents of the display data RAM. If a cache is not used, there are no additional RAM requirements.

It is recommended to use this driver with a data cache for faster display-access. The amount of memory used by the cache may be calculated as follows:

$$\text{Size of RAM (in bytes)} = (\text{LCD\_YSIZE} + 7) / 8 * \text{LCD\_XSIZE}$$

### 13.7.23.5 Additional driver functions

#### LCD\_ControlCache

The detailed description of this function can be found under *LCD\_ControlCache* on page 3464.

### 13.7.23.6 Hardware configuration

This driver accesses the hardware via indirect interface as described in the chapter *Configuration* on page 109. The following table lists the macros which must be defined for hardware access:

Macro	Description
LCD_READ_A0	Read a byte from the display controller with A-line low.
LCD_READ_A1	Read a byte from the display controller with A-line high.
LCD_WRITE_A0	Write a byte to the display controller with A-line low.
LCD_WRITE_A1	Write a byte to the display controller with A-line high.
LCD_WRITE_M_A1	Write multiple bytes to the display controller with A-line high.

#### Display orientation

Some of the supported display controllers supports hardware mirroring of x/y axis. It is recommended to use these functions instead of the display orientation macros of emWin. If mirroring of the X axis is needed, the command `0xA1` (ADC select reverse) should be used in the initialization macro. This causes the display controller to reverse the assignment of column address to segment output. If the display size in X is smaller than the number of segment outputs of the display controller, the macro `LCD_FIRSTSEG0` can be used to add an offset to the column address to make sure, the right RAM address of the display controller is accessed.

If mirroring of the Y axis is needed the command `0xC8` (SHL select revers) should be used in the initialization macro and the macro `LCD_FIRSTCOM0` should be used to define the offset needed to access the right RAM address of the display controller.

### 13.7.23.7 Additional configuration switches

The following table shows optional configuration switches available for this driver:

Macro	Description
<code>LCD_CACHE</code>	When set to 0, no display data cache is used, which slows down the speed of the driver. Default is 1 (cache activated).
<code>LCD_FIRSTCOM0</code>	This macro can be used to define the first common address to be used in the data RAM of the display controller. The value can be determined experimentally or taken from the display doc.
<code>LCD_FIRSTSEG0</code>	This macro can be used to define the first segment address to be used in the data RAM of the display controller. The value can be determined experimentally or taken from the display doc.
<code>LCD_SUPPORT_CACHECONTROL</code>	When set to 1, <code>LCD_ControlCache()</code> can be used.

## 13.7.24 GUIDRV\_07X1

### 13.7.24.1 Supported hardware

#### Controllers

This driver works with the following display controllers:

- Novatek NT7506, NT7508
- Samsung KS0711, KS0741, S6B0711, S6B0741
- Sitronix ST7541, ST7571
- Solomon SSD1854
- ST Microelectronics STE2010
- Tomato TL0350A

#### Bits per pixel

Supported color depth is 2 bpp.

#### Interface

The controller supports either the 8-bit parallel interface as well as the 4-pin or 3-pin serial peripheral interface (SPI). The current version of the driver supports the 8-bit parallel or 4-pin SPI interface. 3 pin SPI is currently not supported.

### 13.7.24.2 Driver selection and configuration

To be able to use this driver the following macro definition needs to be added to the configuration file `LCDConf.h`:

```
#define LCD_USE_07X1
```

After this define has been added the display driver assumes the driver specific configuration file `LCDConf_07X1.h` in the configuration folder. All further compile time configuration macros should be defined in this file. To create a driver device using the `GUIDRV_07X1` for the given display, e.g. the following command can be used:

```
pDevice = GUI_DEVICE_CreateAndLink(GUIDRV_07X1, GUICC_2, 0, 0);
```

Detailed information about palette modes can be found in the chapter *Colors* on page 604.

#### Controller selection

To select the desired controller the macro `LCD_CONTROLLER` should be used in the configuration file `LCDConf_07X1.h`. The following table shows the values to be used to select the appropriate controller:

Number	Supported controller
701	<ul style="list-style-type: none"> <li>• Novatek NT7506</li> <li>• Solomon SSD1854</li> </ul>
702	ST Microelectronics STE2010
711	Samsung KS0711, S6B0711
741	<ul style="list-style-type: none"> <li>• Novatek NT7508</li> <li>• Samsung KS0741, S6B0741</li> <li>• Sitronix ST7541, ST7571</li> <li>• Tomato TL0350A</li> </ul>

### 13.7.24.3 Display data RAM organization

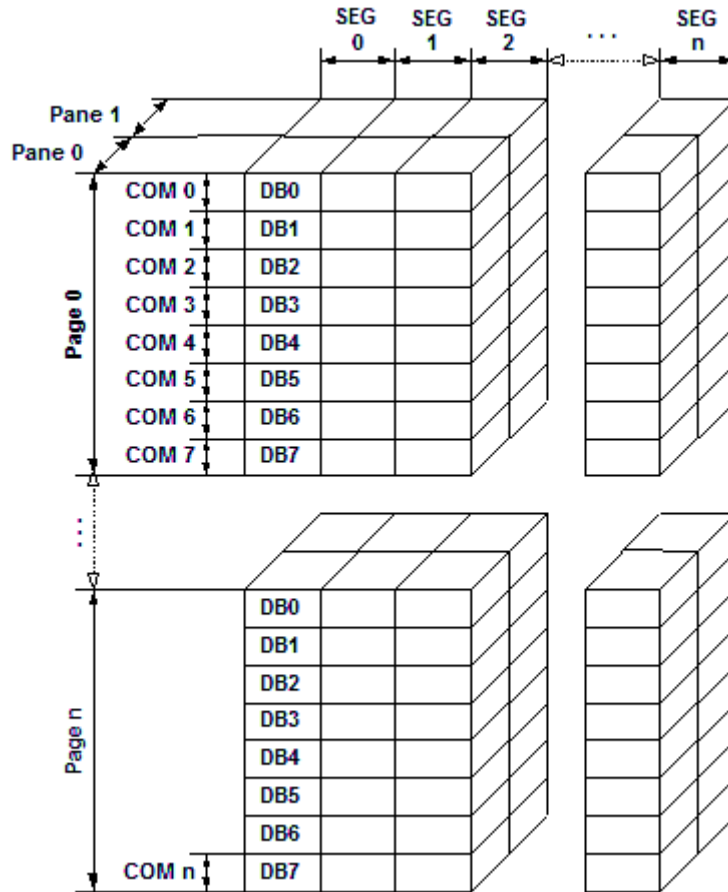

The picture above shows the relation between the display memory and the SEG and COM lines of the display. The display memory is divided into two panes for each pixel. The lower bit of each pixel is stored in pane 0 and the higher bit is stored in pane 1.

### 13.7.24.4 RAM requirements

This display driver may be used with or without a display data cache, containing a complete copy of the contents of the display data RAM. If a cache is not used, there are no additional RAM requirements.

It is recommended to use this driver with a data cache for faster display-access. The amount of memory used by the cache may be calculated as follows:

$$\text{Size of RAM (in bytes)} = (\text{LCD\_YSIZE} + 7) / 8 * \text{LCD\_XSIZE} * 2$$

### 13.7.24.5 Additional driver functions

#### LCD\_ControlCache

The detailed function description can be found {LCD\_ControlCache}.

### 13.7.24.6 Hardware configuration

This driver accesses the hardware using the indirect interface as described in the chapter *Configuration* on page 109. The following table lists the macros which must be defined for hardware access:

Macro	Description
<a href="#">LCD_READ_A0</a>	Read a byte from display controller with A-line low. (Used only if working without cache)

Macro	Description
<a href="#">LCD_READ_A1</a>	Read a byte from display controller with A-line high. (Used only if working without cache)
<a href="#">LCD_WRITE_A0</a>	Write a byte to display controller with A-line low.
<a href="#">LCD_WRITE_A1</a>	Write a byte to display controller with A-line high.
<a href="#">LCD_WRITEM_A1</a>	Write multiple bytes to display controller with A-line high.

### Display orientation

The supported display controllers supports hardware mirroring of x/y axis. It is recommended to use these functions instead of the display orientation macros of emWin. If mirroring of the X axis is needed, the command `0xA1` (ADC select reverse) should be used in the initialization macro. This causes the display controller to reverse the assignment of column address to segment output. If the display size in X is smaller than the number of segment outputs of the display controller, the macro `LCD_FIRSTSEG0` can be used to add an offset to the column address to make sure, the right RAM address of the LCD controller is accessed. If mirroring of the Y axis is needed the command `0xC8` (SHL select revers) should be used in the initialization macro and the macro `LCD_FIRSTCOM0` should be used to define the offset needed to access the right RAM address of the display controller.

### 13.7.24.7 Additional configuration switches

The following table shows optional configuration switches available for this driver:

Macro	Description
<a href="#">LCD_FIRSTCOM0</a>	This macro can be used to define the first common address to be used in the data RAM of the display controller. The value can be determined experimentally or taken from the display documentation.
<a href="#">LCD_FIRSTSEG0</a>	This macro can be used to define the first segment address to be used in the data RAM of the display controller. The value can be determined experimentally or taken from the display documentation.



## 13.7.25 GUIDRV\_6331

### 13.7.25.1 Supported hardware

#### Controllers

This driver works with the following display controllers:

- Samsung S6B33B0X, S6B33B1X, S6B33B2X

#### Bits per pixel

Supported color depth is 16 bpp.

#### Interfaces

The driver supports the indirect interface (8 bit) of the display controller. Parallel or 4-pin SPI bus can be used.

### 13.7.25.2 Driver selection and configuration

To be able to use this driver the following macro definition needs to be added to the configuration file `LCDCConf.h`:

```
#define LCD_USE_6331
```

After this define has been added the display driver assumes the driver specific configuration file `LCDCConf_6331.h` in the configuration folder. All further compile time configuration macros should be defined in this file. To create a driver device using the `GUIDRV_6331` for the given display, e.g. the following command can be used:

```
pDevice = GUI_DEVICE_CreateAndLink(GUIDRV_6331, GUICC_565, 0, 0);
```

Detailed information about palette modes can be found in the chapter *Colors* on page 604.

#### Controller selection

To select the desired controller the macro `LCD_CONTROLLER` should be used in the configuration file `LCDCConf_6331.h`. The table below shows the values to be used to select the appropriate controller:

Number	Supported controller
6331	Samsung S6B33B0X, S6B33B1X, S6B33B2X

### 13.7.25.3 Display data RAM organization

#### 16 bits per pixel, fixed palette = 565

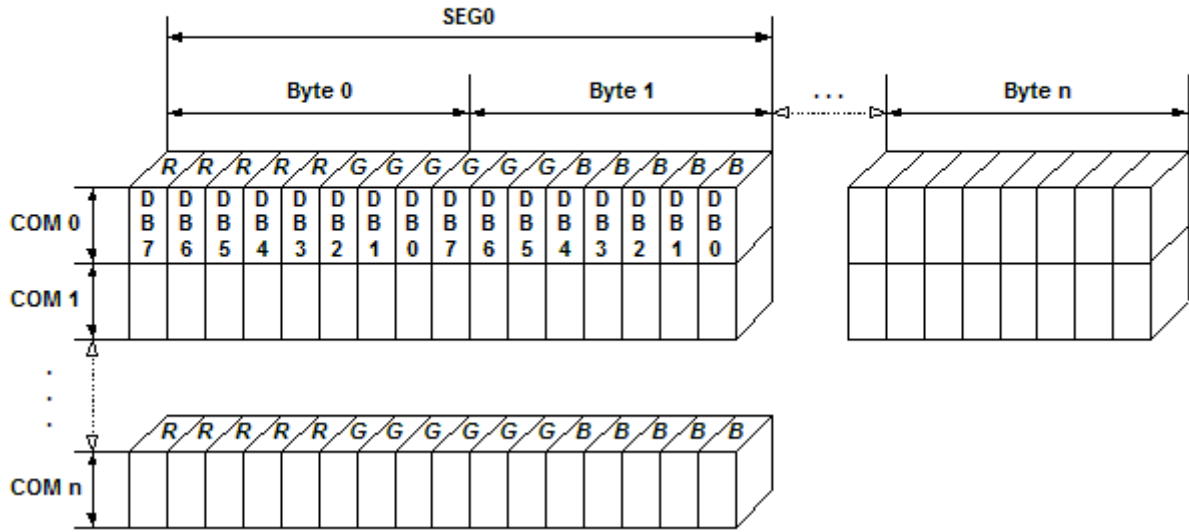

The picture above shows the relation between the display memory and the SEG and COM lines of the LCD.

### 13.7.25.4 RAM requirements

This display driver can be used with or without a display data cache, containing a complete copy of the LCD data RAM. The amount of memory used by the cache is:

```
LCD_XSIZE * LCD_YSIZE * 2 bytes.
```

### 13.7.25.5 Hardware configuration

This driver accesses the hardware with the indirect interface. The following table lists the macros which must be defined for hardware access:

Macro	Description
<a href="#">LCD_WRITE_A0</a>	Write a byte to display controller with A-line low.
<a href="#">LCD_WRITE_A1</a>	Write a byte to display controller with A-line high.
<a href="#">LCD_WRITEM_A1</a>	Write multiple bytes to display controller with A-line high.
<a href="#">LCD_DRIVER_OUTPUT_MODE_DLN</a>	'Display Line Number' (DLN) selection bits of the 'Driver Output Mode Set' instruction. Details can be found in the display controller documentation.
<a href="#">LCD_DRIVER_ENTRY_MODE_16B</a>	Data bus width selection bit of the 'Entry Mode Set' instruction. Details can be found in the display controller documentation.

The 'Driver Output Mode' and 'Entry Mode' are initializes automatically.

### 13.7.25.6 Additional configuration switches

The following table shows optional configuration switches available for this driver:

Macro	Description
<code>LCD_CACHE</code>	When set to 0, no display data cache is used, which slows down the speed of the driver. Default is 1 (cache activated).

### 13.7.25.7 Special requirements

The driver needs to work with the fixed palette mode 565. The driver does not work with other palettes or fixed palette modes. Further the driver needs to swap the red and the blue part of the color index. You should use the following macro definitions in the configuration file `LCDCConf.h`:

```
#define LCD_FIXEDPALETTE 565
#define LCD_SWAP_RB      1
```

## 13.7.26 GUIDRV\_7528

### 13.7.26.1 Supported hardware

#### Controllers

This driver works with the Sitronix ST7528 display controller.

#### Bits per pixel

Supported color depth is 4 bpp.

#### Interfaces

The driver supports the 8 bit parallel (simple bus) 4-pin SPI interface.

### 13.7.26.2 Driver selection and configuration

To be able to use this driver the following macro definition needs to be added to the configuration file `LCDConf.h`:

```
#define LCD_USE_7528
```

After this define has been added the display driver assumes the driver specific configuration file `LCDConf_7528.h` in the configuration folder. All further compile time configuration macros should be defined in this file. To create a driver device using the `GUIDRV_7528` for the given display, e.g. the following command can be used:

```
pDevice = GUI_DEVICE_CreateAndLink(GUIDRV_7528, GUICC_4, 0, 0);
```

Detailed information about palette modes can be found in the chapter *Colors* on page 604.

#### Controller selection

To select the desired controller the macro `LCD_CONTROLLER` should be used in the configuration file `LCDConf_7528.h`. The following table shows the values to be used to select the appropriate controller:

Number	Supported controller
7528	Sitronix ST7528

### 13.7.26.3 Display data RAM organization

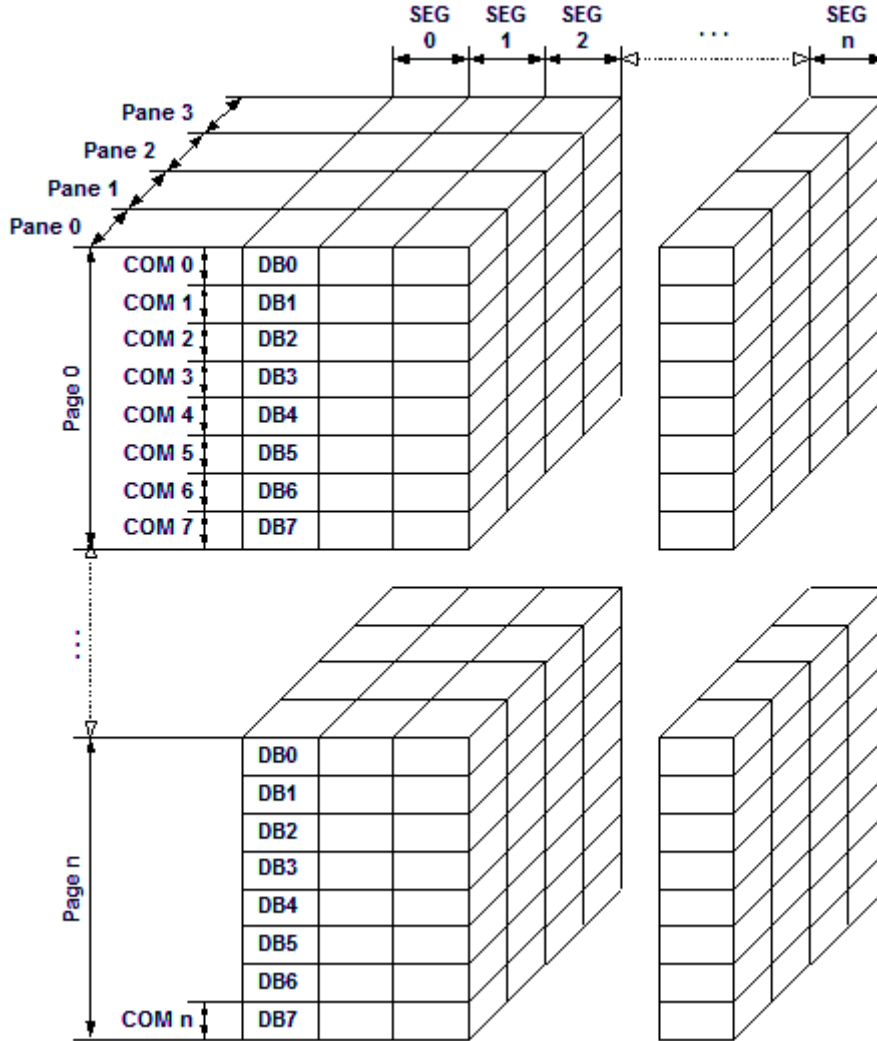

The picture above shows the relation between the display memory and the SEG and COM lines of the LCD. The display memory is divided into four panes for each pixel. The least significant bit (LSB) of each pixel is stored in pane 0 and the MSB is stored in pane 3.

### 13.7.26.4 RAM requirements

This LCD driver may be used with or without a display data cache. If the cache is used it holds a complete copy of the contents of the LCD data RAM. If cache is not used, there are no additional RAM requirements.

It is recommended to use this driver with a data cache for faster LCD-access. The amount of memory used by the cache may be calculated as follows:

$$\text{Size of RAM (in bytes)} = (\text{LCD\_YSIZE} + 7) / 8 * \text{LCD\_XSIZE} * 4$$

A cache is required in SPI mode, because SPI does not allow reading of display contents.

### 13.7.26.5 Hardware configuration

This driver accesses the hardware with the indirect interface. The following table lists the macros which must be defined for hardware access:

Macro	Description
LCD_WRITE_A0	Write a byte to LCD controller with A-line low.
LCD_WRITE_A1	Write a byte to LCD controller with A-line high.

Macro	Description
<code>LCD_WRITE_A1</code>	Write multiple bytes to display controller with A-line high.
<code>LCD_READ_A1</code>	Read a single byte from display controller with A-line high. Required only if no display data cache is configured.
<code>LCD_READM_A1</code>	Read multiple bytes from display controller with A-line high. Required only if no display data cache is configured.

### 13.7.26.6 Additional configuration switches

The following table shows optional configuration switches available for this driver:

Macro	Description
<code>LCD_FIRSTCOM0</code>	This macro can be used to define the first common address to be used in the data RAM of the display controller. The value can be determined experimentally or taken from the display documentation.
<code>LCD_FIRSTSEG0</code>	This macro can be used to define the first segment address to be used in the data RAM of the display controller. The value can be determined experimentally or taken from the display documentation.
<code>LCD_NUM_COM0</code>	A Sitronix ST7528 controller can operate in 2 modes. Mode 0 with 132 segment and 128 common outputs and mode 1 with 160 segment and 100 common outputs. which mode is used depends on hardware, the mode can not be changed via command. Defines the number of available common outputs of the display controller. Possible values for Sitronix ST7528 are: <ul style="list-style-type: none"> <li>• 128 (default, mode 0)</li> <li>• 100 (mode 1)</li> </ul>
<code>LCD_NUM_SEG0</code>	Defines the number of available segment outputs of the display controller. Possible values for Sitronix ST7528 are: <ul style="list-style-type: none"> <li>• 132 (default, mode 0)</li> <li>• 160 (mode 1)</li> </ul>
<code>LCD_CACHE</code>	When set to 0, no display data cache is used, which slows down the speed of the driver. Default is 1 (cache activated).

## 13.7.27 GUIDRV\_7529

### 13.7.27.1 Supported hardware

#### Controllers

This driver works with the Sitronix ST7529 display controller.

#### Bits per pixel

Supported color depths are 5 bpp (default), 4 bpp and 1bpp.

#### Interfaces

The driver supports the indirect interface (8 and 16 bit) of the display controller. Parallel, 3-pin SPI or 4-pin SPI access can be used.

### 13.7.27.2 Driver selection and configuration

To be able to use this driver the following macro definition needs to be added to the configuration file `LCDConf.h`:

```
#define LCD_USE_7529
```

After this define has been added the display driver assumes the driver specific configuration file `LCDConf_7529.h` in the configuration folder. All further compile time configuration macros should be defined in this file. To create a driver device using the `GUIDRV_7529` for the given display, e.g. the following command can be used:

```
pDevice = GUI_DEVICE_CreateAndLink(GUIDRV_7529, GUICC_5, 0, 0);
```

Detailed information about palette modes can be found in the chapter *Colors* on page 604.

#### Controller selection

To select the desired controller the macro `LCD_CONTROLLER` should be used in the configuration file `LCDConf_7529.h`. The following table shows the values to be used to select the appropriate controller:

Number	Supported controller
7529	Sitronix ST7529

### 13.7.27.3 Display data RAM organization

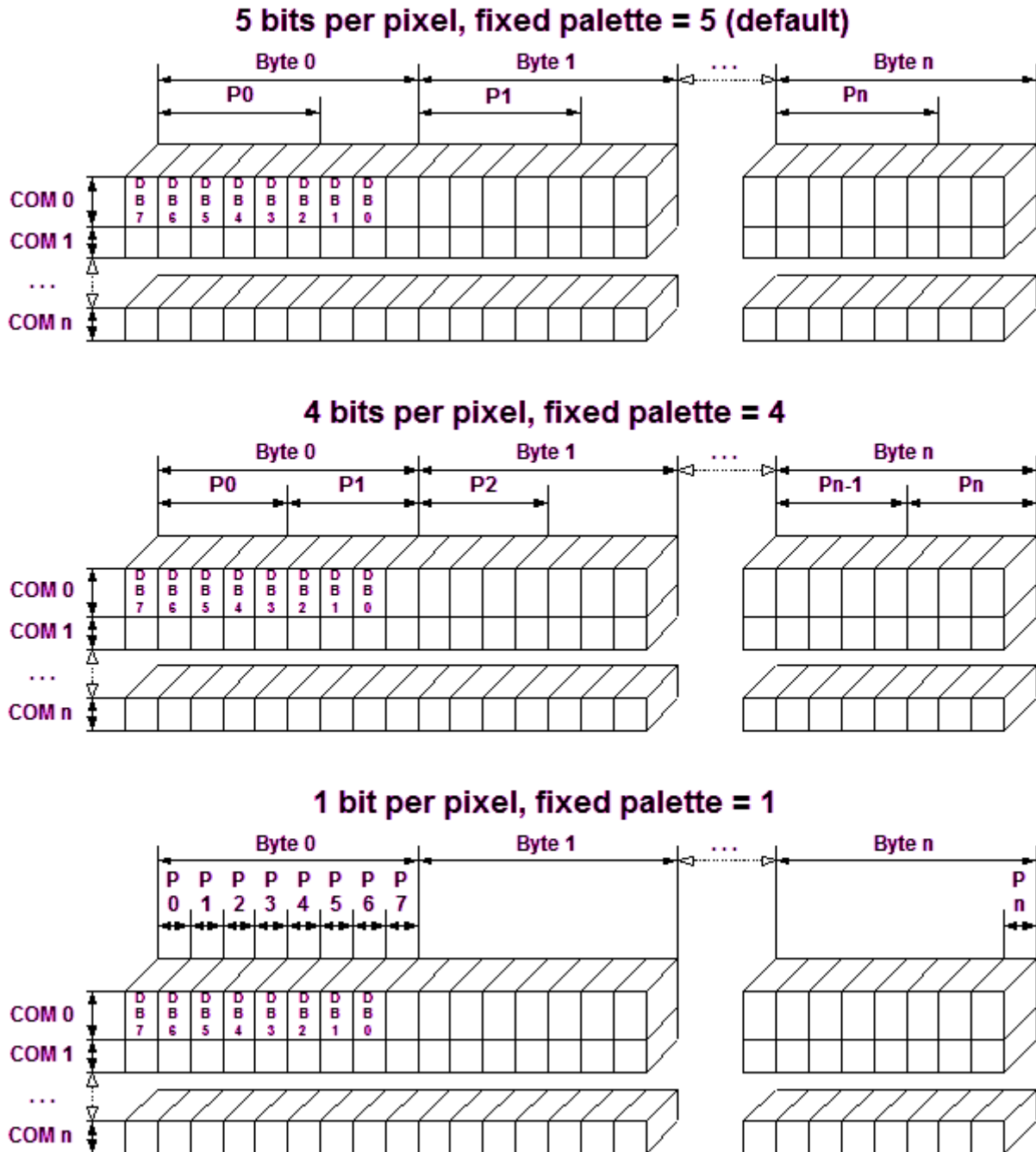

The picture above shows the relation between the display memory and the SEG and COM lines of the LCD.

### 13.7.27.4 RAM requirements

This display driver can be used with or without a display data cache, containing a complete copy of the LCD data RAM. If no cache is used, there are no additional RAM requirements. It is optional (but recommended) to use this driver with a data cache for faster LCD-access. The amount of memory used by the cache may be calculated as follows:

```

5bpp mode:
Size of RAM (in bytes) = (LCD_XSIZE + 2) / 3 * 3 * LCD_YSIZE
4bpp mode:
Size of RAM (in bytes) = ((LCD_XSIZE + 2) / 3 * 3 + 1) / 2 * LCD_YSIZE
1bpp mode:
Size of RAM (in bytes) = ((LCD_XSIZE + 2) / 3 * 3 + 7) / 8 * LCD_YSIZE
    
```



### 13.7.27.5 Hardware configuration

This driver accesses the hardware with the indirect interface. The following table lists the macros which must be defined for hardware access:

Macro	Description
<code>LCD_WRITE_A0</code>	Write a byte to LCD controller with A-line low.
<code>LCD_WRITE_A1</code>	Write a byte to LCD controller with A-line high.
<code>LCD_WRITEM_A1</code>	Write multiple bytes to display controller with A-line high.
<code>LCD_READM_A1</code>	Read multiple bytes from display controller with A-line high. Required only if no display data cache is configured.
<code>LCD_FIRSTPIXELO</code>	If the display size in X is smaller than the number of segment outputs of the display controller, this macro can be used for defining the first visible pixel of the display. It should be used if the first segment lines of the display controller are not connected to the display.

### 13.7.27.6 Additional configuration switches

The following table shows optional configuration switches available for this driver:

Macro	Description
<code>LCD_CACHE</code>	When set to 0, no display data cache is used, which slows down the speed of the driver. Default is 1 (cache activated).

## 13.8 LCD layer and display driver API

This chapter explains functions used to set and get certain layer attributes, for example size, visibility or alpha value of a layer, where each layer is represented by a display driver configured in `LCD_X_Config()`. The chapter also describes how to manage the content of a display driver cache.

Please note that most of the following functions are not thread-safe. Therefore it is recommended to use `GUI_LOCK/GUI_UNLOCK` before/after using them in multitask environments.

### 13.8.1 Display driver API

The table below lists the available routines in alphabetical order. Detailed descriptions follow.

Routine	Description
"Get" group	
<code>LCD_GetBitsPerPixel()</code>	Returns the number of bits per pixel.
<code>LCD_GetBitsPerPixelEx()</code>	Returns the number of bits per pixel of given layer/display.
<code>LCD_GetNumColors()</code>	Return the number of available colors.
<code>LCD_GetNumColorsEx()</code>	Returns the number of available colors of given layer/display.
<code>LCD_GetPosEx()</code>	Returns the position of the given layer in x and y direction.
<code>LCD_GetVRAMAddr()</code>	Returns the address of the framebuffer for the current layer, more precisely the address of the current Write-Buffer.
<code>LCD_GetVRAMAddrEx()</code>	Returns the address of the framebuffer for the given layer, more precisely the address of the current Write-Buffer.
<code>LCD_GetVXSize()</code>	Return virtual X-size of LCD in pixels.
<code>LCD_GetVXSizeEx()</code>	Returns virtual X-size of given layer/display in pixels.
<code>LCD_GetVYSize()</code>	Return virtual Y-size of LCD in pixels.
<code>LCD_GetVYSizeEx()</code>	Returns virtual Y-size of given layer/display in pixels.
<code>LCD_GetXMag()</code>	Returns the magnification factor in x.
<code>LCD_GetXMagEx()</code>	Returns the magnification factor of given layer/display in x.
<code>LCD_GetXSize()</code>	Return physical X-size of LCD in pixels.
<code>LCD_GetXSizeEx()</code>	Returns physical X-size of given layer/display in pixels.
<code>LCD_GetYMag()</code>	Returns the magnification factor in y.
<code>LCD_GetYMagEx()</code>	Returns the magnification factor of given layer/display in y.
<code>LCD_GetYSize()</code>	Return physical Y-size of LCD in pixels.
<code>LCD_GetYSizeEx()</code>	Returns physical Y-size of given layer/display in pixels.
"Set" group	
<code>LCD_SetAlphaEx()</code>	Sets the layer alpha value.*1
<code>LCD_SetAlphaModeEx()</code>	Enables layer alpha mode.*1
<code>LCD_SetChromaEx()</code>	Sets colors to be used for chroma mode.*1
<code>LCD_SetChromaModeEx()</code>	Enables chroma mode.*1

Routine	Description
<code>LCD_SetPosEx()</code>	Sets the layer position of the given layer in x and y direction.
<code>LCD_SetVisEx()</code>	Sets the visibility of a layer.*1
Configuration group	
<code>LCD_SetBufferPtr()</code>	This function is used to set an array with buffer addresses for the currently selected layer.
<code>LCD_SetBufferPtrEx()</code>	This function is used to set an array with buffer addresses for the layer with the given index.
<code>LCD_Off()</code>	Switches the display off.*1
<code>LCD_OffEx()</code>	Switches the given display off.*1
<code>LCD_On()</code>	Switches the display on.*1
<code>LCD_OnEx()</code>	Switches the given display on.*1
<code>LCD_Refresh()</code>	Refreshes the currently selected layer.*1
<code>LCD_RefreshEx()</code>	Refreshes the layer with the given index.*1
<code>LCD_SetDevFunc()</code>	Sets optional or custom defined routines for the display driver.*1
<code>LCD_SetMaxNumColors()</code>	Sets the maximum number of colors used in palette based bitmaps.
<code>LCD_SetSizeEx()</code>	Sets the physical size of the visible area of the given display/layer.
<code>LCD_SetVRAMAddrEx()</code>	Sets the address of the video RAM of the given layer.*1
<code>LCD_SetVSizeEx()</code>	Sets the size of the virtual display area of the given layer.*1
Cache group	
<code>LCD_ControlCache()</code>	Locks, unlocks and flushes the cache of the display controller if it is supported.

**Note**

- Optional function, not supported by each driver.

## 13.8.1.1 "Get" group

### 13.8.1.1.1 LCD\_GetBitsPerPixel()

#### Description

Returns the number of bits per pixel.

#### Prototype

```
int LCD_GetBitsPerPixel(void);
```

#### Return value

Number of bits per pixel.

### 13.8.1.1.2 LCD\_GetBitsPerPixelEx()

#### Description

Returns the number of bits per pixel.

#### Prototype

```
int LCD_GetBitsPerPixelEx(int LayerIndex);
```

#### Parameters

Parameter	Description
<a href="#">Index</a>	Layer index.

#### Return value

Number of bits per pixel.

### 13.8.1.1.3 LCD\_GetNumColors()

#### Description

Returns the number of currently available colors on the LCD.

#### Prototype

```
U32 LCD_GetNumColors(void);
```

#### Return value

Number of available colors.

### 13.8.1.1.4 LCD\_GetNumColorsEx()

#### Description

Returns the number of currently available colors on the LCD.

#### Prototype

```
U32 LCD_GetNumColorsEx(int LayerIndex);
```

#### Parameters

Parameter	Description
<a href="#">Index</a>	Layer index.

#### Return value

Number of available colors.

### 13.8.1.1.5 LCD\_GetPosEx()

#### Description

Returns the position of the given layer in x and y direction.

#### Prototype

```
int LCD_GetPosEx(int LayerIndex,  
                int * pxPos,  
                int * pyPos);
```

#### Parameters

Parameter	Description
<a href="#">LayerIndex</a>	Layer index.
<a href="#">pxPos</a>	Contains layer position in x direction.
<a href="#">pyPos</a>	Contains layer position in y direction.

#### Return value

0 on success  
1 on error.

#### Additional information

The content of the passed pointer is getting filled with values for x and y direction of the given layer.



### 13.8.1.1.6 LCD\_GetVRAMAddr()

#### Description

Returns the address of the framebuffer for the current layer, more precisely the address of the current WriteBuffer.

#### Prototype

```
void *LCD_GetVRAMAddr(void);
```

#### Return value

Void pointer to the framebuffer.

### 13.8.1.1.7 LCD\_GetVRAMAddrEx()

#### Description

Returns the address of the framebuffer for the given layer, more precisely the address of the current WriteBuffer.

#### Prototype

```
void *LCD_GetVRAMAddrEx(int LayerIndex);
```

#### Parameters

Parameter	Description
<code>Index</code>	Layer index.

#### Return value

Void pointer to the framebuffer of the given layer.

### 13.8.1.1.8 LCD\_GetVXSize()

### 13.8.1.1.9 LCD\_GetVYSize()

#### Description

Returns the virtual X- or Y-size, respectively, of the LCD in pixels. In most cases, the virtual size is equal to the physical size.

#### Prototypes

```
int LCD_GetVXSize(void);
```

```
int LCD_GetVYSize(void);
```

#### Return value

Virtual X/Y-size of the display.

### 13.8.1.1.10 LCD\_GetVXSizeEx()

### 13.8.1.1.11 LCD\_GetVYSizeEx()

#### Description

Returns the virtual X- or Y-size, respectively, of the LCD in pixels. In most cases, the virtual size is equal to the physical size.

#### Prototypes

```
int LCD_GetVXSizeEx(int Index);
```

```
int LCD_GetVYSizeEx(int Index);
```

#### Parameters

Parameter	Description
<a href="#">Index</a>	Layer index.

#### Return value

Virtual X/Y-size of the display.

### 13.8.1.1.12 LCD\_GetXMag()

### 13.8.1.1.13 LCD\_GetYMag()

#### Description

Returns the magnification factor in X- or Y-axis, respectively.

#### Prototypes

```
int LCD_GetXMag(void);
```

```
int LCD_GetYMag(void);
```

#### Return value

Magnification factor in X- or Y-axis.

### 13.8.1.1.14 LCD\_GetXMagEx()

### 13.8.1.1.15 LCD\_GetYMagEx()

#### Description

Returns the magnification factor in X- or Y-axis, respectively.

#### Prototypes

```
int LCD_GetXMagEx(int Index);
```

```
int LCD_GetYMagEx(int Index);
```

#### Parameters

Parameter	Description
<a href="#">Index</a>	Layer index.

#### Return value

Magnification factor in X- or Y-axis.

### 13.8.1.1.16 LCD\_GetXSize()

### 13.8.1.1.17 LCD\_GetYSize()

#### Description

Returns the physical X- or Y-size, respectively, of the LCD in pixels.

#### Prototypes

```
int LCD_GetXSize(void);
```

```
int LCD_GetYSize(void);
```

#### Return value

Physical X/Y-size of the display.

### 13.8.1.1.18 LCD\_GetXSizeEx()

### 13.8.1.1.19 LCD\_GetYSizeEx()

#### Description

Returns the physical X- or Y-size, respectively, of the LCD in pixels.

#### Prototypes

```
int LCD_GetXSizeEx(int Index);
```

```
int LCD_GetYSizeEx(int Index);
```

#### Parameters

Parameter	Description
<a href="#">Index</a>	Layer index.

#### Return value

Physical X/Y-size of the display.



## 13.8.1.2 "Set" group

### 13.8.1.2.1 LCD\_SetAlphaEx()

#### Description

Sets the layer alpha value of the given layer.

#### Prototype

```
int LCD_SetAlphaEx(int LayerIndex,  
                  int Alpha);
```

#### Parameters

Parameter	Description
<a href="#">LayerIndex</a>	Layer index.
<a href="#">Alpha</a>	<a href="#">Alpha</a> value (0-255) to be used. 0 means opaque, 255 fully transparent.

#### Return value

0        on success  
1        on error.

#### Additional information

This feature could only be available if the hardware supports layer alpha blending and if the driver callback function reacts on `LCD_X_SETALPHA`. Please note that the actual reaction on the given parameter(s) takes place in the driver callback function and depends on the customers implementation. The callback function is responsible for managing the appropriate SFRs to do the operation.

### 13.8.1.2.2 LCD\_SetAlphaModeEx()

#### Description

Enables the layer alpha mode of the given layer.

#### Prototype

```
int LCD_SetAlphaModeEx(int LayerIndex,  
                      int AlphaMode);
```

#### Parameters

Parameter	Description
LayerIndex	Layer index.
AlphaMode	A list of available modes can be found under <i>Transparency modes</i> on page 225.

#### Return value

0        on success  
1        on error.

#### Additional information

This feature could only be available if the hardware supports layer alpha blending and if the driver callback function reacts on `LCD_X_SETALPHAMODE`. Please note that the actual reaction on the given parameter(s) takes place in the driver callback function and depends on the customers implementation. The callback function is responsible for managing the appropriate SFRs to do the operation. Default behavior of a layer should be pixel alpha mode.

### 13.8.1.2.3 LCD\_SetChromaEx()

#### Description

Sets the colors to be used for the chroma mode.

#### Prototype

```
int LCD_SetChromaEx(int LayerIndex,
                   LCD_COLOR ChromaMin,
                   LCD_COLOR ChromaMax);
```

#### Parameters

Parameter	Description
<a href="#">LayerIndex</a>	Layer index.
<a href="#">ChromaMin</a>	See description below.
<a href="#">ChromaMax</a>	See description below.

#### Return value

0 on success  
1 on error.

#### Additional information

This feature could only be available if the hardware supports chroma blending and if the driver callback function reacts on `LCD_X_SETCHROMA`. The hardware implementations of chroma modes are very different. Because of that the function of the parameters [ChromaMin](#) and [ChromaMax](#) also could have different meanings. In many cases chroma blending only supports one specific transparent color. In that case only the first parameter [ChromaMin](#) should be used. Other systems support a range of color bits to be used or a color and a mask. Please note that the actual reaction on the given parameter(s) takes place in the driver callback function and depends on the customers implementation. The callback function is responsible for managing the appropriate SFRs to do the operation.

### 13.8.1.2.4 LCD\_SetChromaModeEx()

#### Description

Enables the chroma mode of the given layer.

#### Prototype

```
int LCD_SetChromaModeEx(int LayerIndex,  
                        int ChromaMode);
```

#### Parameters

Parameter	Description
<a href="#">LayerIndex</a>	Layer index.
<a href="#">ChromaMode</a>	1 for enabling chroma mode, 0 for disabling (default)

#### Return value

0        on success  
1        on error.

#### Additional information

This feature could only be available if the hardware supports chroma blending and if the driver callback function reacts on `LCD_X_SETCHROMAMODE`. Please note that the actual reaction on the given parameter(s) takes place in the driver callback function and depends on the customers implementation. The callback function is responsible for managing the appropriate SFRs to do the operation.

### 13.8.1.2.5 LCD\_SetPosEx()

#### Description

Sets the layer position of the given layer in x and y direction.

#### Prototype

```
int LCD_SetPosEx(int LayerIndex,  
                int xPos,  
                int yPos);
```

#### Parameters

Parameter	Description
<code>LayerIndex</code>	Layer index.
<code>xPos</code>	New position in x direction.
<code>yPos</code>	New position in y direction.

#### Return value

0        on success  
1        on error.

### 13.8.1.2.6 LCD\_SetVisEx()

#### Description

Sets the visibility of the given layer.

#### Prototype

```
int LCD_SetVisEx(int LayerIndex,  
                int OnOff);
```

#### Parameters

Parameter	Description
LayerIndex	Layer index.
OnOff	1 for visible (default), 0 for invisible.

#### Return value

0        on success  
1        on error.

#### Additional information

This function works properly only if the display driver callback function appropriately reacts to the command `LCD_X_SETVIS`. This in turn requires the display driver callback function to manage the appropriate SFRs accordingly. How to do this in detail is explained in the documentation of the display controller.

## 13.8.1.3 Configuration group

### 13.8.1.3.1 LCD\_SetBufferPtr()

#### Description

This function is used to set an array with buffer addresses for the currently selected layer. This allows incoherent buffers for multi-buffering.

#### Prototype

```
int LCD_SetBufferPtr(void ** pBufferPTR);
```

#### Parameters

Parameter	Description
<code>pBufferPTR</code>	An array with addresses to the different buffers.

#### Return value

0        on success  
1        on error.

#### Additional information

The number of entries in the array must fit to the numbers of buffers set for multi-buffering.

#### Example

```
...  
static const U32 _aBufferPTR[] = {  
    0x00000000, // Begin first buffer  
    0x00800000 // Begin second buffer  
};  
LCD_SetBufferPtr(_aBufferPTR);  
...
```

### 13.8.1.3.2 LCD\_SetBufferPtrEx()

#### Description

This function is used to set an array with buffer addresses for the layer with the given index. This allows incoherent buffers for multi-buffering.

#### Prototype

```
int LCD_SetBufferPtrEx(int LayerIndex,  
                      void ** pBufferPTR);
```

#### Parameters

Parameter	Description
<a href="#">LayerIndex</a>	Index of the layer the buffers are for.
<a href="#">pBufferPTR</a>	An array with addresses to the different buffers.

#### Return value

0 on success  
1 on error.

#### Additional information

The number of entries in the array must fit to the numbers of buffers set for multi-buffering. [pBufferPTR](#) needs to stay valid as long as the emWin driver is in use.



### 13.8.1.3.3 LCD\_Off()

#### Description

Switches the currently selected display off.

#### Return value

0	on success.
1	on error.

### 13.8.1.3.4 LCD\_OffEx()

#### Description

Switches the given display off.

#### Prototype

```
int LCD_OffEx(int LayerIndex);
```

#### Parameters

Parameter	Description
LayerIndex	Index of the layer/display.

#### Return value

0        on success  
1        on error.

### 13.8.1.3.5 LCD\_On()

#### Description

Switches the currently selected display on.

#### Prototype

```
void LCD_On(void);
```

#### Return value

0	on success.
1	on error.

### 13.8.1.3.6 LCD\_OnEx()

#### Description

Switches the given display on.

#### Prototype

```
int LCD_OnEx(int LayerIndex);
```

#### Parameters

Parameter	Description
LayerIndex	Layer index.

#### Return value

0        on success  
1        on error.

### 13.8.1.3.7 LCD\_Refresh()

#### Description

Refreshes the currently selected layer by flushing the entire cache to the LCD.

#### Prototype

```
int LCD_Refresh(void);
```

#### Return value

0        on success  
1        on error.

#### Additional information

This function is only available when using a driver with a cache.

### 13.8.1.3.8 LCD\_RefreshEx()

#### Description

Refreshes the given layer by flushing the entire cache to the LCD.

#### Prototype

```
int LCD_RefreshEx(int LayerIndex);
```

#### Parameters

Parameter	Description
<a href="#">LayerIndex</a>	Layer index.

#### Return value

0        on success  
1        on error.

#### Additional information

This function is only available when using a driver with a cache.

### 13.8.1.3.9 LCD\_SetDevFunc()

#### Description

The function sets additional and / or user defined functions of the display driver.

#### Prototype

```
int LCD_SetDevFunc(int LayerIndex,
                  int IdFunc,
                  void ( *pDriverFunc)());
```

#### Parameters

Parameter	Description
LayerIndex	Layer index.
IdFunc	See table below.
pDriverFunc	Pointer to function which should be used.

Permitted values for element IdFunc	
LCD_DEVFUNC_COPYBUFFER	Can be used to set a custom defined routine for copying buffers. Makes only sense in combination with multiple buffers.
LCD_DEVFUNC_COPYRECT	Can be used to set a custom defined routine for copying rectangular areas.
LCD_DEVFUNC_DRAWBMP_1BPP	Can be used to set a custom routine for drawing 1bpp bitmaps. Makes sense if a custom routine should be used for drawing text and 1bpp bitmaps.
LCD_DEVFUNC_DRAWBMP_8BPP	Can be used to set a custom routine for drawing 8bpp bitmaps. Makes sense if a custom routine should be used for drawing 8bpp bitmaps.
LCD_DEVFUNC_FILLRECT	Can be used to set a custom defined routine for filling rectangles. Makes sense if for example a BitBLT engine should be used for filling operations.
LCD_DEVFUNC_READMPIXELS	Can be used to set a custom defined routine for reading multiple pixels from the display controller.
LCD_DEVFUNC_READPIXEL	Can be used to set a custom defined routine for reading a single pixel from the display controller.
LCD_DEVFUNC_REFRESH	Can be used to set a custom defined routine for refreshing the LCD.

#### LCD\_DEVFUNC\_COPYBUFFER

Can be used to set up a function which copies a frame buffer to the desired location. This can make sense if for example a BitBLT engine is available to do the job. The function pointed by pDriverFunc should be of the following type:

```
void CopyBuffer(int LayerIndex,
               int IndexSrc,
               int IndexDst);
```

Parameter	Description
LayerIndex	Layer index.

Parameter	Description
<code>IndexSrc</code>	Index of the source frame buffer to be copied.
<code>IndexDst</code>	Index of the destination frame buffer to be overwritten.

### LCD\_DEVFUNC\_COPYRECT

Can be used to set up a function which copies a rectangular area of the screen to the desired location. This can make sense if for example a BitBLT engine is available to do the job. The function pointed by `pDriverFunc` should be of the following type:

```
void CopyRect(int LayerIndex,
             int x0,
             int y0,
             int x1,
             int y1,
             int xSize,
             int ySize);
```

Parameter	Description
<code>LayerIndex</code>	Layer index.
<code>x0</code>	Leftmost pixel of the source rectangle.
<code>y0</code>	Topmost pixel of the source rectangle.
<code>x1</code>	Leftmost pixel of the destination rectangle.
<code>y1</code>	Topmost pixel of the destination rectangle.
<code>xSize</code>	X-size of the rectangle.
<code>ySize</code>	Y-size of the rectangle.

### LCD\_DEVFUNC\_DRAWBMP\_1BPP

Can be used to set up a function which draws 1bpp bitmaps which includes also text. This can make sense if for example a BitBLT engine is available to do the job. The function pointed by `pDriverFunc` should be of the following type:

```
void DrawBMP1(int LayerIndex,
             int x,
             int y,
             U8 const * p,
             int Diff,
             int xSize,
             int ySize,
             int BytesPerLine,
             const LCD_PIXELINDEX * pTrans);
```

Parameter	Description
<code>LayerIndex</code>	Layer index.
<code>x</code>	Leftmost coordinate in screen coordinates of the bitmap to be drawn.
<code>y</code>	Topmost coordinate in screen coordinates of the bitmap to be drawn.
<code>p</code>	Pointer to the pixel data of the bitmap.
<code>Diff</code>	Offset to the first pixel pointed by parameter <code>p</code> . Supported values are 0-7.
<code>xSize</code>	X-size in pixels of the bitmap to be drawn.
<code>ySize</code>	Y-size in pixels of the bitmap to be drawn.
<code>BytesPerLine</code>	Number of bytes of one line of bitmap data.



Parameter	Description
<code>pTrans</code>	Pointer to an array of color indices to be used to draw the bitmap data. The first color index defines the background color, the second color index defines the foreground color.

### Return value

0 on success  
1 on error.

### Additional information

Please note that it depends on the display driver which values for parameter `IdFunc` are supported or not.

### LCD\_DEVFUNC\_DRAWBMP\_8BPP

Can be used to set up a function which draws 8bpp palette based bitmaps. This can make sense if for example a BitBLT engine is available to do the job. The function pointed by `pDriverFunc` should be of the following type:

```
void DrawBMP8(
    int LayerIndex,
    int x,
    int y,
    U8 const * p,
    int xSize,
    int ySize,
    int BytesPerLine,
    const LCD_PIXELINDEX * pTrans);
```

Parameter	Description
<code>LayerIndex</code>	Layer index.
<code>x</code>	Leftmost coordinate in screen coordinates of the bitmap to be drawn.
<code>y</code>	Topmost coordinate in screen coordinates of the bitmap to be drawn.
<code>p</code>	Pointer to the pixel data of the bitmap.
<code>xSize</code>	X-size in pixels of the bitmap to be drawn.
<code>ySize</code>	Y-size in pixels of the bitmap to be drawn.
<code>BytesPerLine</code>	Number of bytes of one line of bitmap data.
<code>pTrans</code>	Pointer to an array of color indices to be used to draw the bitmap data. These colors are addressed by the index values of the pixels.

### Return value

0 on success  
1 on error.

### Additional information

Please note that it depends on the display driver which values for parameter `IdFunc` are supported or not.

### LCD\_DEVFUNC\_FILLRECT

Can be used to set a custom function for filling operations. The function pointed by `pDriverFunc` should be of the following type:

```
void FillRect(int LayerIndex,
             int x0,
```

```

int y0,
int x1,
int y1,
U32 PixelIndex);

```

Parameter	Description
<code>LayerIndex</code>	Layer index.
<code>x0</code>	Leftmost coordinate to be filled in screen coordinates.
<code>y0</code>	Topmost coordinate to be filled in screen coordinates.
<code>x1</code>	Rightmost coordinate to be filled in screen coordinates.
<code>y1</code>	Bottommost coordinate to be filled in screen coordinates.
<code>PixelIndex</code>	Color index to be used to fill the specified area.

### LCD\_DEVFUNC\_READMPIXELS

Can be used to set a custom defined routine for reading multiple pixels from the display controller. The function pointed by `pDriverFunc` should be one of the following types:

```

void _ReadMPixels(int LayerIndex,
                 U16 * pBuffer,
                 U32 NumPixels);

void _ReadMPixels(int LayerIndex,
                 U32 * pBuffer,
                 U32 NumPixels);

```

Parameter	Description
<code>LayerIndex</code>	Layer index.
<code>pBuffer</code>	Pointer to the buffer in which the pixel data has to be stored.
<code>NumPixels</code>	Number pixels to read.

The required function type depends on the configured color depth of the display driver. In 16bpp mode a `U16` pointer is required for the buffer and for 18bpp up to 32bpp a `U32` pointer is required.

### LCD\_DEVFUNC\_READPIXEL

Can be used to set a custom defined routine for reading a single pixel from the display controller. The function pointed by `pDriverFunc` should be one of the following types:

```

U16 _ReadPixel(int LayerIndex);

U32 _ReadPixel(int LayerIndex);

```

Parameter	Description
<code>LayerIndex</code>	Layer index.

The required type of the return value depends on the configured color depth of the display driver. In 16bpp mode `U16` is required and for 18bpp up to 32bpp `U32` is required.

### LCD\_DEVFUNC\_REFRESH

Can be used to set a custom defined routine for updating the display with `LCD_Refresh()`. The function pointed by `pDriverFunc` should be of the following type:

```

void (int LayerIndex);

```

Parameter	Description
<code>LayerIndex</code>	Layer index.

Purpose of `LCD_DEVFUNC_REFRESH` is to be able to set a custom function which triggers a display refresh. Whereas some drivers with indirect interface already have such a function,

it can also be used with `GUIDRV_Lin`. In case of a display with DSI-interface it could be used to set a function for triggering a DSI-transfer.

### 13.8.1.3.10 LCD\_SetMaxNumColors()

#### Description

Sets the maximum number of colors used in palette based bitmaps.

#### Prototype

```
int LCD_SetMaxNumColors(unsigned MaxNumColors);
```

#### Parameters

Parameter	Description
<code>MaxNumColors</code>	Maximum number of colors used in palette based bitmaps. Default is 256.

#### Return value

0        on success  
1        on error.

#### Additional information

During the process of initialization emWin allocates a buffer required for converting color values of the bitmaps into index values for the controller. This buffer requires 4 bytes per color. If the system is short on RAM and only a few colors are used, this function could spare up to 1016 bytes of dynamically RAM. Per default the buffer uses 1024 bytes of RAM. But if for example only 2 colors are used (typically b/w-configuration) only 8 bytes for 2 colors are required. The function needs to be called by the routine `GUI_X_Config()`.

### 13.8.1.3.11 LCD\_SetSizeEx()

#### Description

Sets the physical size of the visible area of the given display/layer.

#### Prototype

```
int LCD_SetSizeEx(int LayerIndex,  
                 int xSize,  
                 int ySize);
```

#### Parameters

Parameter	Description
<a href="#">LayerIndex</a>	Layer index.
<a href="#">xSize</a>	X-Size in pixels of the visible area of the given layer.
<a href="#">ySize</a>	Y-Size in pixels of the visible area of the given layer.

#### Return value

0        on success  
1        on error.

#### Additional information

The function requires a display driver which is able to manage dynamically changes of the display size. If the display driver does not support this feature the function fails.

### 13.8.1.3.12 LCD\_SetVRAMAddrEx()

#### Description

Sets the address of the video RAM.

#### Prototype

```
int LCD_SetVRAMAddrEx(int LayerIndex,  
                      void * pVRAM);
```

#### Parameters

Parameter	Description
LayerIndex	Layer index.
pVRAM	Pointer to start address of video RAM.

#### Return value

0 on success  
1 on error.

#### Additional information

The function requires a display driver which is able to manage dynamically changes of the video RAM address. If the display driver does not support this feature the function fails.

### 13.8.1.3.13 LCD\_SetVSizeEx()

#### Description

Sets the size of the virtual display area.

#### Prototype

```
int LCD_SetVSizeEx(int LayerIndex,  
                  int xSize,  
                  int ySize);
```

#### Parameters

Parameter	Description
<a href="#">LayerIndex</a>	Layer index.
<a href="#">xSize</a>	X-Size in pixels of the virtual area of the given layer.
<a href="#">ySize</a>	Y-Size in pixels of the virtual area of the given layer.

#### Return value

0        on success.  
1        on error.

#### Additional information

The function requires a display driver which is able to manage dynamically changes of the virtual display size. If the display driver does not support this feature the function fails.

## 13.8.1.4 Cache group

### 13.8.1.4.1 LCD\_ControlCache()

#### Description

Locks, unlocks and flushes the cache of the display controller if it is supported.

#### Prototype

```
int LCD_ControlCache(int Cmd);
```

#### Parameters

Parameter	Description
Cmd	See table below.

Permitted values for element <a href="#">Cmd</a>	
LCD_CC_FLUSH	Flushes the cache. The content of the cache which has changed since the last flushing operation is output to the display.
LCD_CC_LOCK	Locks the cache. Drawing operations are cached, but not output to the display.
LCD_CC_UNLOCK	Unlocks the cache. The cached data is flushed immediately. Further drawing operations are cached and output. (Write Through)

#### Return value

0        on success  
1        on error.

#### Additional information

The function requires a display driver which is able to manage dynamically changes of the virtual display size. If the display driver does not support this feature the function fails. This function is automatically used for drawing operations of windows and strings.



# Chapter 14

## Touch drivers

---

A touch driver supports a particular family of touch controllers and all touch pads which are connected to one of these controllers. The drivers can be configured by modifying their configuration files whereas the driver itself does not need to be modified. The configuration files contain all required information for the driver including how the hardware is accessed and how the controller(s) are connected to the display. This chapter provides an overview of the touch drivers available for emWin. It explains the following in terms of each driver:

- Which touch controllers can be accessed and which interface can be used.
- RAM requirements.
- Driver specific functions.
- How to access the hardware.
- Special configuration switches.
- Special requirements for particular touch controllers.

## 14.1 GUIMTDRV\_TangoC32

The driver is written for the multi touch controller TangoC32 from PIXCIR. It is delivered along with the emWin MultiTouch feature.

The controller can be accessed via I2C interface. It provides an interrupt line which needs to be used by the application to generate an interrupt. Once the driver has been initialized right it automatically fills up the multi touch buffer of emWin.

### 14.1.1 Supported hardware

This driver works with the following controller:

- PIXCIR Tango C32

### 14.1.2 Driver initialization

A good place for initializing the touch driver is the routine `LCD_X_Config()`. This makes sure, that the touch driver and the display driver has been initialized before emWin is used by the application.

#### First part

The first part of initializing the driver is calling the drivers configuration function. It sets up the function pointers for hardware communication.

#### Second part

To be able to do its work the drivers execution function needs to be called when touching the screen. That should be done via interrupt routine. For that case the touch controller provides an interrupt line which is active if a touch event occurs. The one and only thing which then should be done in the interrupt routine is calling the drivers execution function `GUIMTDRV_TangoC32_Exec()`.

### 14.1.3 GUIMTDRV\_TangoC32 API

The following table shows the available functions of the driver.

Routine	Description
<code>GUIMTDRV_TangoC32_Init()</code>	Configuration function.
<code>GUIMTDRV_TangoC32_Exec()</code>	Execution function.

### 14.1.3.1 GUIMTDRV\_TangoC32\_Init()

#### Description

Passes a pointer to a `GUIMTDRV_TANGOC32_CONFIG` structure to the driver. This structure contains all required function pointers and values required by the driver.

#### Prototype

```
int GUIMTDRV_TangoC32_Init(GUIMTDRV_TANGOC32_CONFIG * pConfig);
```

#### Parameters

Parameter	Description
<code>pConfig</code>	Pointer to a <code>GUIMTDRV_TANGOC32_CONFIG</code> structure described below.

#### Elements of structure `GUIMTDRV_TANGOC32_CONFIG`

Data type	Element
<code>void (*)(U8 SlaveAddr)</code>	<code>pf_I2C_Init</code>
<code>int (*)(U8 * pData, int Start, int Stop)</code>	<code>pf_I2C_Read</code>
<code>int (*)(U8 * pData, int NumItems, int Start, int Stop)</code>	<code>pf_I2C_ReadM</code>
<code>int (*)(U8 Data, int Start, int Stop)</code>	<code>pf_I2C_Write</code>
<code>int (*)(U8 * pData, int NumItems, int Start, int Stop)</code>	<code>pf_I2C_WriteM</code>
<code>U8</code>	<code>SlaveAddr</code>

#### `pf_I2C_Init()`

Parameter	Description
<code>SlaveAddr</code>	I2C Slave address of touch controller to be used.

That pointer should point to a function which initializes the I2C communication. The element `SlaveAddr` is passed to the given function to set up the slave address of the touch controller device (normally `0x5C`).

#### `pf_I2C_Read()`

Parameter	Description
<code>pData</code>	Pointer to an unsigned character to store the byte.
<code>Start</code>	Is set to 1 if bus communication starts, otherwise 0.
<code>Stop</code>	Is set to 1 if bus communication should end after the read operation, otherwise 0.

That function is responsible for reading one byte of data. The given pointer `pData` is used to store the value.

Returns 0 on success, otherwise 1.

#### `pf_I2C_ReadM()`

Parameter	Description
<code>pData</code>	Pointer to a buffer to be filled by the routine.
<code>NumItems</code>	Number of bytes to be read.
<code>Start</code>	Is set to 1 if bus communication starts, otherwise 0.
<code>Stop</code>	Is set to 1 if bus communication should end after the read operation, otherwise 0.

That function is responsible for reading multiple bytes of data. The given pointer `pData` is used to store the value.

Returns 0 on success, otherwise 1.

### **pf\_I2C\_Write()**

Parameter	Description
<code>Data</code>	Byte to be written.
<code>Start</code>	Is set to 1 if bus communication starts, otherwise 0.
<code>Stop</code>	Is set to 1 if bus communication should end after the write operation, otherwise 0.

That function is responsible for writing one byte of data.

Returns 0 on success, otherwise 1.

### **pf\_I2C\_WriteM()**

Parameter	Description
<code>pData</code>	Pointer to buffer to be written.
<code>NumItems</code>	Number of bytes to be written.
<code>Start</code>	Is set to 1 if bus communication starts, otherwise 0.
<code>Stop</code>	Is set to 1 if bus communication should end after the write operation, otherwise 0.

That function is responsible for writing multiple bytes of data. The given pointer `pData` is used to store the value.

### **Return value**

Returns 0 on success, otherwise 1.

## 14.2 GUITDRV\_ADS7846

### 14.2.1 Supported hardware

This driver works with the following controller:

- Texas Instruments ADS7846 touch screen controller

### 14.2.2 Driver initialization

A good place for initializing the touch driver is the routine `LCD_X_Config()`. This makes sure, that the touch driver and the display driver has been initialized before `emWin` is used by the application.

#### First part

The first part of initializing the driver is calling the drivers configuration function. It sets up the following things:

- Function pointers for hardware communication routines
- Touch panel orientation to be used
- Logical and physical AD values to be able to calculate the right position depending on the AD values of the controller

#### Second part

To be able to do its work the drivers execution function needs to be called periodically. We recommend an interval of 20-30 ms. The function call can be done from within a timer interrupt routine or from a separate task.

### 14.2.3 GUITDRV\_ADS7846 API

The following table shows the available functions of the driver.

Routine	Description
<code>GUITDRV_ADS7846_Config()</code>	Configuration function.
<code>GUITDRV_ADS7846_Exec()</code>	Execution function.
<code>GUITDRV_ADS7846_GetLastVal()</code>	Retrieves the last stored values.

### 14.2.3.1 GUITDRV\_ADS7846\_Config()

#### Description

Passes a pointer to a GUITDRV\_ADS7846\_CONFIG structure to the driver. This structure contains all required function pointers and values required by the driver.

#### Prototype

```
void GUITDRV_ADS7846_Config(GUITDRV_ADS7846_CONFIG * pConfig);
```

#### Parameters

Parameter	Description
<code>pConfig</code>	Pointer to a GUITDRV_ADS7846_CONFIG structure described below.

Permitted values for element Orientation	
GUI_MIRROR_X	Mirroring the X-axis
GUI_MIRROR_Y	Mirroring the Y-axis
GUI_SWAP_XY	Swapping X- and Y-axis

Data type	Element	Description
<code>void (*)(U8 Data)</code>	<code>pfSendCmd</code>	Hardware routine for sending a byte to the controller via its SPI interface.
<code>U16 (*)(void)</code>	<code>pfGetResult</code>	Hardware routine for getting the AD conversion result of the controller via its SPI interface. The driver uses the 12 bit conversion mode. Per conversion the controller uses 16 clocks. Only the first 12 bits contain the result to be returned by this routine.
<code>char (*)(void)</code>	<code>pfGetBusy</code>	Hardware routine for getting the busy state of the controller. The routine should return 1 if the controller is busy and 0 if not.
<code>void (*)(char OnOff)</code>	<code>pfSetCS</code>	Routine for toggling the CS signal of the controller. When receiving 1 the signal should become high and vice versa.
<code>unsigned</code>	Orientation	One or more "OR" combined values of the table below.
<code>int</code>	<code>xLog0</code>	Logical X value 0 in pixels.
<code>int</code>	<code>xLog1</code>	Logical X value 1 in pixels.
<code>int</code>	<code>xPhys0</code>	A/D converter value for <code>xLog0</code> .
<code>int</code>	<code>xPhys1</code>	A/D converter value for <code>xLog1</code> .
<code>int</code>	<code>yLog0</code>	Logical Y value 0 in pixels.
<code>int</code>	<code>yLog1</code>	Logical Y value 1 in pixels.
<code>int</code>	<code>yPhys0</code>	A/D converter value for <code>yLog0</code> .
<code>int</code>	<code>yPhys1</code>	A/D converter value for <code>yLog1</code> .
<code>char (*)(void)</code>	<code>pfGetPENIRQ</code>	If the PENIRQ line of the touch controller is connected to a port of the target hardware a touch event can be detected by the driver. Upon polling the driver's exec routine the driver can check if a touch event is ready to be sampled by checking the PENIRQ line. Without PENIRQ line the driver will always try to sample

Data type	Element	Description
		<p>a touch event even if no touch happened which will consume time even if not necessary. Without PENIRQ it is the responsibility of the user's <code>pfGetResult()</code> routine to return <code>0xFFFF</code> if the measured AD value is out of bounds. If both, the PENIRQ and the touch pressure recognition are enabled first the PENIRQ will signal that there is a touch event. Afterwards the touch pressure measurement is used to confirm that this was a valid touch and the touch had enough pressure to deliver good measurements.</p> <p>The routine should return 1 if a touch event is recognized and 0 if not.</p>
int	PressureMin	Minimum pressure threshold. A measured pressure below this value means we do not have a valid touch event.
int	PressureMax	Maximum pressure threshold. A measured pressure above this value means we do not have a valid touch event.
int	PlateResistanceX	Resistance of the X-plate of the touch screen. This value is needed for calculation of the touch pressure.

### 14.2.3.2 GUITDRV\_ADS7846\_Exec()

#### Description

Execution function of the touch driver.

#### Prototype

```
char GUITDRV_ADS7846_Exec(void);
```

#### Return value

- 0 No update has occurred.
- 1 Touch has been updated.

#### Additional information

We recommend to call the routine each 20-30 ms. If the routine detects a valid touch event it stores the result into the touch buffer via a function call to `GUI_TOUCH_StoreStateEx()`. Please note that the driver needs some function pointers to be filled correctly to be able to communicate with the external peripheral. The correct assignment of these function pointers is checked during driver configuration and leads to an abort to `GUI_ErrorOut()` on missing pointers.



### 14.2.3.3 GUITDRV\_ADS7846\_GetLastVal()

#### Description

Retrieves the last stored values for some internal variables that might be needed for calibration of the driver without knowing its internals.

#### Prototype

```
void GUITDRV_ADS7846_GetLastVal(GUITDRV_ADS7846_LAST_VAL * p);
```

#### Parameters

Parameter	Description
<code>p</code>	Pointer to a GUITDRV_ADS7846_LAST_VAL structure.

#### Elements of structure GUITDRV\_ADS7846\_LAST\_VAL

Data type	Element	Description
int	xPhys	Last measured x value
int	yPhys	Last measured y value
int	z1Phys	Last measured z1 value
int	z2Phys	Last measured z2 value
int	PENIRQ	Last sampled PENIRQ state if PENIRQ callback has been set
int	Pressure	Last measured touch pressure if touch pressure measurement is enabled

#### Additional information

This function is an optional function and not required to be able to use the driver.

# Chapter 15

## Performance and Resource Usage

---

High performance combined with low resource usage has always been a major design consideration. emWin runs on 8/16/32-bit CPUs. Depending on which modules are being used, even single-chip systems with less than 64 KB ROM and 2 KB RAM can be supported by emWin. The actual performance and resource usage depends on many factors (CPU, compiler, memory model, optimization, configuration, display controller interface, etc.). This chapter contains benchmarks and information about resource usage in typical systems which can be used to obtain sufficient estimates for most target systems.

# 15.1 Performance

The following chapter shows driver benchmarks on different targets and performance values of image drawing operations.

## 15.1.1 Driver benchmark

We use a benchmark test to measure the speed of the display drivers on available targets. This benchmark is in no way complete, but it gives an approximation of the length of time required for common operations on various targets.

### Configuration and performance table

CPU	LCD Controller (GUIDRV_...)	bpp	Bench1 Filling	Bench2 Small fonts	Bench3 Bit fonts	Bench4 Bitmap 1bpp	Bench5 Bitmap 2bpp	Bench6 Bitmap 4bpp	Bench7 Bitmap 8bpp	Bench8 DDP bitmap
<b>ARM Cortex-A9</b>										
RZA1 (360MHz)	(internal) ...LIN16	16	335M	15.9M	21.8M	32.6M	21.2M	19.8M	10.0M	62.4M
RZA1 (360MHz)	(internal) ...LIN32	32	182M	14.0M	20.3M	25.7M	24.2M	22.7M	12.7M	69.1M
<b>ARM Cortex-M4</b>										
ST-M32F429 (168MHz)	(internal) ...LIN8	8	182M	2.74M	3.67M	5.67M	2.02M	1.94M	2.30M	21.4M
ST-M32F429 (168MHz)	(internal) ...LIN16	16	131M	3.65M	5.19M	7.68M	4.08M	3.89M	20.64M	25.59M
ST-M32F429 (168MHz)	(internal) ...LIN32	32	67.7M	3.65M	5.22M	7.80M	5.68M	5.14M	20.98M	20.11M
ST-M32F407 (168MHz)	(external) FLEXCOLOR *1	16	5.9M	1.14M	1.75M	2.52M	2.04M	1.94M	1.14M	5.67M
MK66FN2 (168MHz)	(external) FLEXCOLOR *2	16	981.35K	504.36K	564.5K	635.68K	616.09K	604.03K	560.38K	876.54K
<b>ARM720T</b>										
ARM720T (50MHz)	(internal) (3200)	16	7.14M	581K	1.85M	1.96M	694K	645K	410K	2.94M
<b>ARM9</b>										
AR-M926EJ-S (200MHz)	(internal) (3200)	16	123M	3.79M	5.21M	7.59M	2.27M	2.21M	1.77M	15.2M

#### Legend

- **M** - Megapixels per second
- **K** - Kilopixels per second
- \*1 - 16 bit parallel interface
- \*2 - 8 bit serial interface

**Bench1: Filling**

Bench the speed of filling. An area of 64×64 pixels is filled with different colors.

**Bench2: Small fonts**

Bench the speed of small character output. An area of 60×64 pixels is filled with small-character text.

**Bench3: Big fonts**

Bench the speed of big character output. An area of 65×48 pixels is filled with big-character text.

**Bench4: Bitmap 1bpp**

Bench the speed of 1bpp bitmaps. An area of 58×8 pixels is filled with a 1bpp bitmap.

**Bench 5: Bitmap 2bpp**

Bench the speed of 2bpp bitmaps. An area of 32×11 pixels is filled with a 2bpp bitmap.

**Bench6: Bitmap 4bpp**

Bench the speed of 4bpp bitmaps. An area of 32×11 pixels is filled with a 4bpp bitmap.

**Bench7: Bitmap 8bpp**

Bench the speed of 8bpp bitmaps. An area of 32×11 pixels is filled with a 8bpp bitmap.

**Bench8: Device-dependent bitmap, 8 or 16 bpp**

Bench the speed of bitmaps 8 or 16 bits per pixel. An area of 64 pixels is filled with a bitmap. The color depth of the tested bitmap depends on the configuration. For configurations ≤ 8bpp, a bitmap with 8 bpp is used; 16bpp configurations use a 16-bpp bitmap.

## 15.1.2 Image drawing performance (Bitmap, BMP and GIF)

The following table shows the drawing performance of the various image formats supported by emWin. The measurement for the following table has been done on an ARM Cortex-A9 (RZA1H) running with 360MHz and with 16bpp display color depth using `GUIDRV_LIN_16`:

Image format	Megapixels per second
Internal bitmap format: 1bpp C file	47.5
Internal bitmap format: 4bpp C file	27.5
Internal bitmap format: 8bpp C file	41.6
Internal bitmap format: 16bpp C file, high color	103
Internal bitmap format: 24bpp C file, true color 888	8.0
Internal bitmap format: RLE4 C file	14.5
Internal bitmap format: RLE8 C file	16.4
Internal bitmap format: RLE16 C file	10.3
BMP file 8bpp	44.6
BMP file 16bpp	4.6
BMP file 24bpp	5.7
BMP file 32bpp	5.6
BMP file RLE4	32.9
BMP file RLE8	23.2
GIF file	4.1

### 15.1.3 Image drawing performance (JPEG)

The following tables showing measurements of JPEG decoding and drawing.

The JPEG decoder is able to use five different software for computing the IDCT during the decoding process of a JPEG image. Details about configuring the desired IDCT algorithm can be found in the chapter *IDCT configuration* on page 463.

- All results are in MPixels/s.
- The term 'PRO' means progressive encoded JPEG images.

#### 15.1.3.1 STM32F769I (STM32F769I-Discovery)

The measurement for the following tables has been done on an **STM32F769I** CPU running with **200MHz** and a color configuration of 16bpp. Used IDE is **SEGGER Embedded Studio for ARM V7.30** with **Segger compiler** toolchain.

##### Note

No hardware acceleration has been used

##### Performance of the JPEG decoder only

The following table shows the performance of the actual decoder with the drawing function disabled.

IDCT-Configuration	Gray	H1V1	H1V2	H2V1	H2V2	Gray (PRO)	H1V1 (PRO)	H1V2 (PRO)	H2V1 (PRO)	H2V2 (PRO)
I32_SCALAR	3.640	1.525	1.977	2.141	2.540	1.623	0.720	0.918	0.969	1.131
I16_SCALAR	3.767	1.534	1.994	2.177	2.576	1.641	0.718	0.917	0.972	1.129

##### Performance of displaying JPEG images

The following table shows the performance of the complete process of drawing JPEG images.

IDCT-Configuration	Gray	H1V1	H1V2	H2V1	H2V2	Gray (PRO)	H1V1 (PRO)	H1V2 (PRO)	H2V1 (PRO)	H2V2 (PRO)
I32_SCALAR	1.646	1.347	1.701	1.809	2.099	1.053	0.678	0.854	0.897	1.035
I16_SCALAR	1.668	1.344	1.712	1.828	2.114	1.063	0.678	0.856	0.902	1.039

#### 15.1.3.2 R7FA6M3AH3CFC (EK-RA6M3G)

The measurement for the following tables has been done on an **R7FA6M3AH3CFC** CPU running with **120MHz** and a color configuration of 16bpp. Used IDE is **Renesas e<sup>2</sup>Studio** with **GCC** toolchain.

##### Note

Hardware acceleration has been used. Note that not all formats are supported by the hardware accelerator and limited amount of available RAM prevented the drawing of some JPEG formats.

Anyway, the tables showing a huge performance boost by using a dedicated hardware accelerator for JPEG decoding.

##### Performance of the JPEG decoder only

The following table shows the performance of the actual decoder with the drawing function disabled.

IDCT-Configuration	Gray	H1V1	H1V2	H2V1	H2V2	Gray (PRO)	H1V1 (PRO)	H1V2 (PRO)	H2V1 (PRO)	H2V2 (PRO)
I32_SCALAR	0.259	9.011	0.466	10.915	11.919	0.0	0.0	0.0	0.0	0.0
I16_SCALAR	0.262	9.011	0.468	10.915	11.919	0.0	0.0	0.0	0.0	0.0

### Performance of displaying JPEG images

The following table shows the performance of the complete process of drawing JPEG images.

IDCT-Configuration	Gray	H1V1	H1V2	H2V1	H2V2	Gray (PRO)	H1V1 (PRO)	H1V2 (PRO)	H2V1 (PRO)	H2V2 (PRO)
I32_SCALAR	0.202	8.879	0.357	10.925	11.919	0.0	0.0	0.0	0.0	0.0
I16_SCALAR	0.204	8.879	0.358	10.915	11.919	0.0	0.0	0.0	0.0	0.0

## 15.2 RAM requirements

This chapter does not contain the RAM requirement of each single module but shows the features with appreciable additional RAM requirement. The operation area of emWin varies widely, depending primarily on the application and features used. Because of that it's quite difficult to estimate the memory requirements for emWin applications. Instead of listing each module or widget individually, it makes more sense to explain the memory requirements of different features in a functional context.

### 15.2.1 Display driver

In general, it is important to distinguish between drivers with direct and indirect interfaces.

#### Direct interface

The most important display driver for that kind of interface is `GUIDRV_LIN`. In a direct interface configuration, video memory is directly accessible by the CPU; the address bus is connected to the display controller. That means the display driver manages the content of the frame buffer directly via the address bus. But that also means that RAM requirement for the frame buffer must be considered which depends on the used color depth and the display size.

For one single frame buffer the RAM requirement can be calculated as follows:

```
SizeOfFrameBuffer in bytes = BitsPerPixel * xSize * ySize / 8
```

Most drivers require a few additional bytes for a context structure and a small line buffer.

#### Indirect interface

These drivers usually work with COG displays with controller 'on board' or separate display controllers on the target hardware. This also means that the driver has no direct access to the framebuffer. In this case (usually) no framebuffer is needed on the CPU side, which saves RAM. With one exception: if the display is not readable, the driver needs a cache, which then contains the contents of the framebuffer. For non-readable displays with indirect interface the same amount of memory is needed as described above for the direct interface.

### 15.2.2 Multibuffering

This feature is used to avoid tearing and flickering effects and normally only used with display drivers with direct interface. The memory requirement is calculated by multiplying the size of a single buffer by the number of required buffers

### 15.2.3 Antialiasing

To be able to calculate at least one line of antialiased content emWin requires 3 line buffers for the whole display width with a color depth of 32 bpp. That means a display of 480 pixels requires an additional buffer of  $3 * 480 * 4$  bytes for antialiased operations.

### 15.2.4 Memory devices

Some functions of emWin (e.g. high quality image scaling, rotary widget and more...) are only available with the optional memory device module. The chapter *Memory Requirements* shows in detail how much memory is required under certain circumstances.

### 15.2.5 Widgets

The RAM requirements of the widgets are different. Widgets like a `BUTTON` or a `CHECKBOX` do not have a notable RAM requirement. However, other widgets can have quite a big influence on the memory footprint. For example the `LISTVIEW` or `LISTBOX` may contain

a large number of texts. Another example is the ROTARY widget which requires memory devices.

## 15.2.6 Fonts

Fonts do not increase the RAM requirement of an application. With one important exception: In case of using the TrueType-engine at runtime the RAM requirement increases significantly. For that case details can be found in chapter *TrueType Font (TTF) format*.

## 15.2.7 Core

And last but not least the basic functions for converting color palettes of bitmaps require a buffer for the converted palettes which uses per default 1 KByte of RAM. More details can be found in the chapter *Optimizing RAM requirement*

## 15.2.8 Stack

The basic stack requirement is approximately 600 bytes. If using the Window Manager additional 1000 bytes should be calculated. For Memory Devices further additional 200 bytes are recommended. Please note that the stack requirement also depends on the application, the used compiler and the CPU. If enough RAM is available and you want to be on the safe side, simply set the stack size to 4 KBytes. This should also be enough for unusual applications and protect against surprises.

## 15.2.9 Orientation device

First of all: This device is not the most recommended method for rotating the display. But if the used display driver does not support changing the display orientation the orientation device could be used. Please note that this device uses as much memory as required to hold a copy of the complete frame buffer. The additional memory requirement of this feature is  $xSizeDisplay * ySizeDisplay * 4$ . Details can be found in the chapter `GUI_SetOrientation()`.

## 15.2.10 Language module

The amount of additional RAM required depends on the kind of use of the language module and on the size of the text files used. Details can be found in the chapter *Text- and language resource files*.



## 15.3 Memory requirements of example applications

Because it is quite impossible to list the exact memory requirements for the GUI components, we made 3 example applications:

- Hello World application
- Window Manager application
- AppWizard application

In dependence of the used toolchain the values of the following measurements can vary on different systems.

### 15.3.1 Measurement Environment

The memory requirement for the example applications have been measured with the following environment:

What is used:	
CPU	STM32F769
IDE	SEGGER Embedded Studio V7.30
Compiler	SEGGER
Linker	SEGGER
Display size	800x480
Display driver	GUIDRV_LIN_16
Color configuration	16 bpp, GUICC_M565
Compiler optimization	'Level 2 for size'

### 15.3.2 Included Content

The tables below do not contain the requirements for the following:

- Display controller management
- Standard libraries
- Operating system

The lists contain only the memory requirement of the emWin related code. We have excluded the display controller management, because it is very different and depends a lot of the used driver. Whereas drivers with indirect interface often only require a short initialization sequence, drivers with direct interface like `GUIDRV_LIN` require more overhead.

Also the memory requirement for the standard libraries has been excluded. The memory requirement here often varies a lot.

For convenience we used our operating system `embOS` to initialize the CPU on the one hand and to provide emWin with a time base on the other hand, for which actually also a simple timer interrupt is sufficient.

### 15.3.3 'Hello World' application

Details about how to write a hello world application can be found in the chapter *The "Hello world" example program* on page 108.

#### 15.3.3.1 Configuration

To get a realistic result for an application which does not make use of advanced features like the window manager, memory devices or multitasking, we have used the following configuration:

Feature	State
Window Manager	Off
Memory Devices	Off
MultiTasking	Off
MultiBuffering	Off

#### 15.3.3.2 Memory Requirement

The following table shows the memory requirement of a hello world application.

	ROM	RAM
Code	10.980	
RO Data	2.857	
RW Data		96
ZI Data		548
<b>Summary</b>	<b>13.837</b>	<b>644</b>
+Framebuffer		768.000
+Memory		4.096
+Stack		600
<b>Summary</b>	<b>13.837</b>	<b>773.340</b>

#### ROM

Code and const data for emWin is app. 14 KBytes

#### RAM

RAM requirement is app. 5.5 KBytes (including GUI memory and stack size). Because the resolution of the display is quite large the frame buffer requires additional  $800 \times 480 \times 2 = 750$  KBytes.

## 15.3.4 Window manager application

It is difficult to write 'the' typical WindowManager application because, for one thing, the widgets needed for it can be very different and, depending on the application, more or less data and other resources such as bitmaps are used in them. Because of that we decided to use the following application which is from optical aspects not representative:

But it references a quite large amount of widgets which is important to get a realistic impression of the ROM requirement of emWin.

### 15.3.4.1 Configuration

We have used the following configuration:

Feature	State
Window Manager	On
Memory Devices	On
MultiTasking	On
MultiBuffering	On

### 15.3.4.2 Memory Requirement

The following table shows the memory requirement of a Window Manager application.

	ROM	RAM
Code	146.092	
RO Data	25.844	
RW Data		2.351
ZI Data		1.747
<b>Summary</b>	<b>171.936</b>	<b>4.098</b>
+Framebuffer		1.536.000
+Memory		25.600
+Stack		2.000
<b>Summary</b>	<b>171.936</b>	<b>1.567.698</b>

#### ROM

Code and const data for emWin is app. 170 KBytes

#### RAM

RAM requirement is app. 31 KBytes (including GUI memory and stack size). Because the resolution of the display is quite large the frame buffers (we need 2 for doublebuffering) require additional  $800 \times 480 \times 2 \times 2 = 1.500$  KBytes.

## 15.4 Optimizing footprint

The amount of RAM and ROM required by emWin could be optimized in some cases. This chapter shows when it is possible to spare some RAM and/or ROM and how that could be achieved.

### 15.4.1 Optimizing RAM requirement

In general the application should not allocate much more memory as required by the application. But unfortunately it is not possible providing a simple formula which can be used for that. If the simulation is used it is possible to open a window which shows the current amount of used/free memory of the executing application by right-clicking the simulation window. For details please also refer to *View system info* on page 197. All of the below shown RAM optimizations can be done with a precompiled library.

#### Systems using bitmaps with less than 256 colors

If less than 256 colors are used by bitmaps the size of the buffer required for bitmap palette conversion could be reduced. Per default palettes with up to 256 colors can be converted. That requires  $256 * 4 = 1024$  bytes. If the bitmaps used by the application use less than 256 colors the size of the buffer could be reduced. That could be done by calling the function `LCD_SetMaxNumColors()` with the maximum number of colors used by bitmaps. Details can be found in the description of `LCD_SetMaxNumColors` on page 3460.

#### Systems using a display driver with indirect interface

If the system is short on RAM and a driver with indirect interface is used it is recommended not to use a display driver cache. If the display controller supports reading back frame buffer data it should be possible to use the driver without a cache. Details about cache configuration can be found in the respective display driver description.

#### Systems using multi tasking support (GUI\_OS == 1)

If multiple tasks are configured emWin uses a maximum of 4 tasks per default. That requires approx. 110 bytes per task which makes  $4 * 110 = 440$  bytes. If less than 4 GUI-tasks are used that can be done by fine tuning the maximum number of tasks by calling the function `GUI_TASK_SetMaxTask()` from `GUI_X_Config()`. For details please also refer to the function `GUI_TASK_SetMaxTask` on page 120.

### 15.4.2 Optimizing ROM requirement

In general here can not be done much on emWin side. But may some features could be disabled which spare a few KByte of ROM requirement. The below shown optimizations can only be done when compiling the source code of emWin.

#### Using the Window Manager without transparent windows

If the application does not require transparent windows the source of emWin can be compiled with the following option set in the configuration file `GUIConf.h`:

```
#define WM_SUPPORT_TRANSPARENCY 0
```

#### Disable text rotation

If the application does not use the functions for drawing rotated text the code required for that operations can be disabled by inserting the following define in the configuration file `GUIConf.h`:

```
#define GUI_SUPPORT_ROTATION 0
```

# Chapter 16

## Support

---

This chapter should help if any problem occurs. This could be a problem with the tool chain, with the hardware, the use of the GUI functions or with the performance and it describes how to contact emWin support.

## 16.1 Problems with tool chain (compiler, linker)

The following shows some of the problems that can occur with the use of your tool chain. The chapter tries to show what to do in case of a problem and how to contact the emWin support if needed.

### 16.1.1 Compiler crash

You ran into a tool chain (compiler) problem, not a problem of emWin. If one of the tools of your tool chain crashes, you should contact your compiler support:

```
"Tool internal error, please contact support"
```

### 16.1.2 Compiler warnings

The code of emWin has been tested on different target systems and with different compilers. We spend a lot of time on improving the quality of the code and we do our best to avoid compiler warnings. But the sensitivity of each compiler regarding warnings is different. So we can not avoid compiler warnings for unknown tools.

#### Warnings you should not see

These kinds of warnings should not occur:

```
"Function has no prototype"  
"Incompatible pointer types"  
"Variable used without having been initialized"  
"Illegal redefinition of macro"
```

#### Warnings you may see

Warnings such as the ones below should be ignored:

```
"Integer conversion, may lose significant bits"  
"Statement not reached"  
"Descriptionless statements were deleted during optimization"  
"Condition is always true/false"  
"Unreachable code"
```

Most compilers offer a way to suppress selected warnings.

#### Warning "Parameter not used"

Depending of the used configuration sometimes not all of the parameters of the functions are used. To avoid compiler warnings regarding this problem you can define the macro `GUI_USE_PARA` in the file `GUIConf.h` like the following example:

```
#define GUI_USE_PARA(para) (void)para
```

emWin uses this macro wherever necessary to avoid this type of warning.

### 16.1.3 Compiler errors

emWin assumes that the used compiler is ANSI C compatible. The compiler should cover at least one of the following standards:

- ISO/IEC/ANSI 9899:1990 (C90) with support for C++ style comments (//)
- ISO/IEC 9899:1999 (C99)
- ISO/IEC 14882:1998 (C++)

## Limited number of arguments in a function pointer call

But some compilers are not 100% ANSI C compatible and have for example a limitation regarding the number of arguments in a function pointer call:

```
typedef int tFunc(int a, int b, int c, int d, int e,
                 int f, int g, int h, int i, int j);
static int _Func(int a, int b, int c, int d, int e,
                int f, int g, int h, int i, int j) {
    return a + b + c + d + e + f + g + h;
}
static void _Test(void) {
    int Result;
    tFunc * pFunc;
    pFunc = _Func;
    Result = pFunc(1, 2, 3, 4, 5, 6, 7, 8, 9, 10);
}
```

If the example above can not be compiled, only the core version of emWin can be used. The additional packages of emWin like the Window Manager or the Memory Device module sometimes need to pass up to 10 parameters with a function pointer call. The core package of emWin needs only up to 2 parameters in a function pointer call. But you can also use emWin if your compiler only supports one argument in a function pointer call. If so some functions are not available, for example rotating text or UTF-8 encoding.

## 16.1.4 Linker problems

### Undefined externals

If your linker shows the error message "Undefined external symbols...", check if the following files have been included to the project or library:

- All source files shipped with emWin
- In case of a simple bus interface: One of the hardware routines located in the folder **Sample\LCD\_X\_Port**. For details about this, refer to the chapter *Configuration* on page 109.
- One of the files located in the folder **Sample\GUI\_X**. Details about this can be found in the chapter *Configuration* on page 109.

### Executable too large

Some linkers are not able to link only the modules/functions referenced by the project. This results in an executable with a lot of unused code. In this case the use of a library would be very helpful. For details about how to build an emWin library, refer to the chapter *Getting Started* on page 90.

## 16.2 Problems with hardware/driver

If your tools are working fine but your display does not work may one of the following helps to find the problem.

### **Stack size to low?**

Make sure that there have been configured enough stack. Unfortunately we can not estimate exactly how much stack will be used by your configuration and with your compiler. Further the required stack size depends a lot on the application.

### **Initialization of the display wrong?**

Please check if the controller initialization has been adapted to your needs.

### **Display interface configured wrong?**

When starting to work with emWin and the display does not show something you should use an oscilloscope to measure the pins connected with the display/controller. If there is a problem, check the following:

- If using a simple bus interface: Probably the hardware routines have not been configured correctly. If possible use an emulator and step through these routines.
- If using a full bus interface: Probably the register/memory access have not been configured correctly.



## 16.3 Problems with API functions

If your tool chain and your hardware works fine but the API functions do not function as documented, make a small example as described in *Contacting support* on page 3491. This allows us to easily reproduce the problem and solve it quickly.

## 16.4 Problems with the performance

If there is any performance problem with emWin it should be determined, which part of the software causes the problem.

### Does the driver cause the problem?

To determine the cause of the problem the first step should be writing a small test routine which executes some test code and measures the time used to execute this code. Starting point should be the file `ProblemReport.c` described above. To measure the time used by the real hardware driver the shipment of emWin contains the driver `GUIDRV_NULL`. This driver can be used if no output to the hardware should be done. Selecting `GUIDRV_NULL` can be achieved by the same way as setting up a real driver:

```
GUI_DEVICE_CreateAndLink(GUIDRV_LIN_16, GUICC_565, 0, 0);
```

The difference between the used time by the real driver and `GUIDRV_NULL` shows the execution time spent in the real hardware driver.

### Driver not optimized?

If there is a significant difference between the use of the real driver and `GUIDRV_NULL` the cause of the problem could be a not optimized driver mode. If working with a driver which does not use the default orientation (nothing mirrored, nothing swapped) the driver may not be optimized for the configured mode. In this case, please contact our support, we should be able to optimize the code.

### Comparable results

To be able to measure the hardware performance for having a comparable result, emWin comes with 2 samples (located in the folder **Sample\Tutorial**) which could be used for measuring the hardware performance. The first one is `BASIC_DriverPerformance.c`. It measures the time required for different kinds of drawing operations which should be supported by each driver. The second one is `BASIC_Performance.c`. It calculates prime numbers and prints the result of reached loops/second. This sample could be used to check the basic configuration of the CPU.

## 16.5 Contacting support

If you need to contact the emWin support, send the following information to the support:

- A detailed description of the problem may written as comment in the example code.
- The configuration files `GUIConf.c`, `GUIConf.h`, `LCDConf.c`, `LCDConf.h`.
- An example source file which can be compiled in the simulation without any additional files as described in the following.
- If there are any problems with the tool chain, also send the error message of the compiler/linker.
- If there are any problems with the hardware/driver and a simple bus interface is used, also send the hardware routines including the configuration.

### Problem report

The following file can be used as a starting point when creating a problem report. Also fill in the CPU, the used tool chain and the problem description. It can be found under **Sample\Tutorial\ProblemReport.c**:

```

/*****
 *          SEGGER Microcontroller GmbH & Co. KG          *
 *      Solutions for real time microcontroller applications *
 *
 *          emWin problem report                          *
 *
 *****/
-----
File           : ProblemReport.c
CPU            :
Compiler/Tool chain :
Problem description :
-----
*/
#include "GUI.h"
/* Add further GUI header files here as required. */
/*****
 *
 *      Static code
 *
 *****/
* Please insert helper functions here if required.
*/
/*****
 *
 *      MainTask
 *
*/
void MainTask(void) {
    GUI_Init();
    /*
     * To do: Insert the code here which demonstrates the problem.
     */
    while (1); /* Make sure program does not terminate */
}

```

## 16.6 FAQ

Q: *I use a different LCD controller. Can I still use emWin?*

A: Yes. The hardware access is done in the driver module and is completely independent of the rest of the GUI. The appropriate driver can be easily written for any controller (memory-mapped or bus-driven). Please get in touch with us.

Q: *Which CPUs can I use emWin with?*

A: emWin can be used with any CPU (or MPU) for which a C compiler exists. Of course, it will work faster on 16/32-bit CPUs than on 8-bit CPUs.

Q: *Is emWin flexible enough to do what I want to do in my application?*

A: emWin should be flexible enough for any application. If for some reason you do not think it is in your case, please contact us. Believe it or not, the source code is available.

Q: *Does emWin work in a multitask environment?*

A: Yes, it has been designed with multitask kernels in mind.

Q: *Can I update my emWin application to the latest version without any problems?*

A: Yes, since emWin is kept backward compatible. For example, macros are added when a function name has been changed. However, if any migration issues appear when updating to a newer version, please contact us and let us know.

# Chapter 17

## Indexes

---

## 17.1 Function index

BUTTON\_Create, **1181**  
 BUTTON\_CreateAsChild, **1182**  
 BUTTON\_CreateEx, **1183**  
 BUTTON\_CreateIndirect, 973, 973, **1184**, 2743, 2743, 3191  
 BUTTON\_CreateUser, **1185**  
 BUTTON\_GetBitmap, **1186**  
 BUTTON\_GetBkColor, **1187**  
 BUTTON\_GetDefaultBkColor, **1188**  
 BUTTON\_GetDefaultFont, **1189**  
 BUTTON\_GetDefaultTextAlign, **1190**  
 BUTTON\_GetDefaultTextColor, **1191**  
 BUTTON\_GetFont, **1192**  
 BUTTON\_GetSkinFlexProps, 2803  
 BUTTON\_GetText, **1193**  
 BUTTON\_GetTextAlign, **1194**  
 BUTTON\_GetTextColor, **1195**  
 BUTTON\_GetUserData, **1196**  
 BUTTON\_IsPressed, **1197**  
 BUTTON\_SetBitmap, **1198**  
 BUTTON\_SetBitmapEx, **1199**  
 BUTTON\_SetBkColor, **1200**  
 BUTTON\_SetBMP, **1201**  
 BUTTON\_SetBMPEX, **1202**  
 BUTTON\_SetDefaultBkColor, **1203**  
 BUTTON\_SetDefaultFocusColor, **1204**  
 BUTTON\_SetDefaultFont, **1205**  
 BUTTON\_SetDefaultSkin, 2803  
 BUTTON\_SetDefaultTextAlign, **1206**  
 BUTTON\_SetDefaultTextColor, **1207**  
 BUTTON\_SetFocusColor, **1208**  
 BUTTON\_SetFont, **1210**  
 BUTTON\_SetFrameColor, **1211**  
 BUTTON\_SetPressed, **1212**  
 BUTTON\_SetReactOnLevel, **1213**  
 BUTTON\_SetReactOnTouch, **1214**  
 BUTTON\_SetSkin, 2803  
 BUTTON\_SetSkinFlexProps, 2803, **2817**  
 BUTTON\_SetStreamedBitmap, **1215**, 1215  
 BUTTON\_SetStreamedBitmapEx, **1216**  
 BUTTON\_SetText, **1217**, 3192  
 BUTTON\_SetTextAlign, **1218**  
 BUTTON\_SetTextColor, **1219**  
 BUTTON\_SetTextOffset, **1220**  
 BUTTON\_SetToggleMode, **1221**  
 BUTTON\_SetUserData, **1222**  
 BUTTON\_Toggle, **1223**  
 CALENDAR\_AddKey, **2753**  
 CALENDAR\_Create, **2754**  
 CALENDAR\_GetDate, **2755**  
 CALENDAR\_GetDaysOfMonth, **2756**  
 CALENDAR\_GetSel, **2757**  
 CALENDAR\_GetWeekday, **2758**  
 CALENDAR\_SetDate, **2759**  
 CALENDAR\_SetDefaultBkColor, **2761**  
 CALENDAR\_SetDefaultColor, **2762**  
 CALENDAR\_SetDefaultDays, **2763**  
 CALENDAR\_SetDefaultFont, **2764**  
 CALENDAR\_SetDefaultMonths, **2765**  
 CALENDAR\_SetDefaultSize, **2766**  
 CALENDAR\_SetSel, **2760**  
 CALENDAR\_ShowDate, **2767**  
 CHECKBOX\_Create, **1232**  
 CHECKBOX\_CreateEx, **1233**  
 CHECKBOX\_CreateIndirect, 2743, 2743  
 CHECKBOX\_GetBkColor, **1236**  
 CHECKBOX\_GetBoxBkColor, **1237**  
 CHECKBOX\_GetDefaultAlign, **1238**  
 CHECKBOX\_GetDefaultBkColor, **1239**  
 CHECKBOX\_GetDefaultFont, **1240**  
 CHECKBOX\_GetDefaultSpacing, **1241**  
 CHECKBOX\_GetDefaultTextColor, **1243**  
 CHECKBOX\_GetFocusColor, **1244**  
 CHECKBOX\_GetFont, **1245**  
 CHECKBOX\_GetImage, **1246**

CHECKBOX\_GetSkinFlexButtonSize, **2822**  
 CHECKBOX\_GetState, **1247**  
 CHECKBOX\_GetText, **1248**  
 CHECKBOX\_GetTextAlign, **1249**  
 CHECKBOX\_GetTextColor, **1250**  
 CHECKBOX\_IsChecked, **1252**  
 CHECKBOX\_SetBkColor, **1253**  
 CHECKBOX\_SetBoxBkColor, **1254**  
 CHECKBOX\_SetDefaultAlign, **1255**  
 CHECKBOX\_SetDefaultBkColor, **1256**  
 CHECKBOX\_SetDefaultFocusColor, **1257**  
 CHECKBOX\_SetDefaultFont, **1258**  
 CHECKBOX\_SetDefaultImage, **1259**  
 CHECKBOX\_SetDefaultSpacing, **1260**  
 CHECKBOX\_SetDefaultTextColor, **1262**  
 CHECKBOX\_SetFocusColor, **1263**  
 CHECKBOX\_SetFont, **1264**  
 CHECKBOX\_SetImage, **1265**  
 CHECKBOX\_SetNumStates, **1266**  
 CHECKBOX\_SetSkinFlexButtonSize, **2823**  
 CHECKBOX\_SetSkinFlexProps, **2824**  
 CHECKBOX\_SetSpacing, **1267**  
 CHECKBOX\_SetState, **1268**  
 CHECKBOX\_SetText, **1269**  
 CHECKBOX\_SetTextAlign, **1270**  
 CHECKBOX\_SetTextColor, **1271**  
 CHOOSECOLOR\_Create, **2774**  
 CHOOSECOLOR\_GetSel, **2775**  
 CHOOSECOLOR\_SetDefaultBorder, **2779**  
 CHOOSECOLOR\_SetDefaultButtonSize, **2780**  
 CHOOSECOLOR\_SetDefaultColor, **2777**  
 CHOOSECOLOR\_SetDefaultSpace, **2778**  
 CHOOSECOLOR\_SetSel, **2776**  
 CHOOSEFILE\_Create, **2784**  
 CHOOSEFILE\_EnableToolTips, **2785**  
 CHOOSEFILE\_SetButtonText, **2786**  
 CHOOSEFILE\_SetDefaultButtonText, **2787**  
 CHOOSEFILE\_SetDelim, **2788**  
 CHOOSEFILE\_SetToolTips, **2789**  
 CHOOSEFILE\_SetTopMode, **2790**  
 Draw, 2914, 2915, 2974, 2975  
 DROPDOWN\_AddString, **1281**  
 DROPDOWN\_Clear, **1282**  
 DROPDOWN\_Collapse, **1283**  
 DROPDOWN\_Create, **1284**  
 DROPDOWN\_CreateEx, **1285**  
 DROPDOWN\_CreateIndirect, **1286**  
 DROPDOWN\_CreateUser, **1287**  
 DROPDOWN\_DecSel, **1288**  
 DROPDOWN\_DecSelExp, **1289**  
 DROPDOWN\_DeleteItem, **1290**  
 DROPDOWN\_EnableMotion, **1291**  
 DROPDOWN\_Expand, **1292**  
 DROPDOWN\_GetBkColor, **1293**  
 DROPDOWN\_GetColor, **1294**  
 DROPDOWN\_GetDefaultFont, **1295**  
 DROPDOWN\_GetFont, **1296**  
 DROPDOWN\_GetItemDisabled, **1297**  
 DROPDOWN\_GetItemText, **1298**  
 DROPDOWN\_GetListbox, **1299**  
 DROPDOWN\_GetNumItems, **1300**  
 DROPDOWN\_GetSel, **1301**  
 DROPDOWN\_GetSelExp, **1302**  
 DROPDOWN\_GetTextColor, **1303**  
 DROPDOWN\_GetUserData, **1304**  
 DROPDOWN\_IncSel, **1305**  
 DROPDOWN\_IncSelExp, **1306**  
 DROPDOWN\_InsertString, **1307**  
 DROPDOWN\_SetAutoScroll, **1308**  
 DROPDOWN\_SetBkColor, **1309**  
 DROPDOWN\_SetColor, **1310**  
 DROPDOWN\_SetDefaultColor, **1311**  
 DROPDOWN\_SetDefaultFont, **1312**  
 DROPDOWN\_SetDefaultScrollbarColor, **1313**  
 DROPDOWN\_SetFont, **1314**  
 DROPDOWN\_SetItemDisabled, **1315**

DROPDOWN\_SetItemSpacing, **1316**  
 DROPDOWN\_SetListHeight, **1317**  
 DROPDOWN\_SetScrollbarColor, **1318**  
 DROPDOWN\_SetScrollbarWidth, **1319**  
 DROPDOWN\_SetSel, **1320**  
 DROPDOWN\_SetSelExp, **1321**  
 DROPDOWN\_SetSkinFlexProps, **2829**  
 DROPDOWN\_SetText, **1322**  
 DROPDOWN\_SetTextAlign, **1323**  
 DROPDOWN\_SetTextColor, **1324**  
 DROPDOWN\_SetTextHeight, **1325**  
 DROPDOWN\_SetUpMode, **1326**  
 DROPDOWN\_SetUserData, **1327**  
 EDIT\_AddKey, **1336**  
 EDIT\_Create, **1337**  
 EDIT\_CreateAsChild, **1338**  
 EDIT\_CreateEx, **1339**  
 EDIT\_CreateIndirect, **1340**, 2743, 2743, 2743, 2743  
 EDIT\_CreateUser, **1341**  
 EDIT\_EnableAutoScroll, **1342**  
 EDIT\_EnableBlink, **1343**  
 EDIT\_EnableInversion, **1344**  
 EDIT\_GetBkColor, **1345**  
 EDIT\_GetBorderSize, **1346**  
 EDIT\_GetCharAtPixel, **1347**  
 EDIT\_GetCursorCharPos, **1348**  
 EDIT\_GetCursorPixelPos, **1349**  
 EDIT\_GetDefaultBkColor, **1350**  
 EDIT\_GetDefaultFont, **1351**  
 EDIT\_GetDefaultTextAlign, **1352**  
 EDIT\_GetDefaultTextColor, **1353**  
 EDIT\_GetFloatValue, **1354**  
 EDIT\_GetFont, **1355**  
 EDIT\_GetMinMax, **1356**  
 EDIT\_GetNumChars, **1357**  
 EDIT\_GetSel, **1358**  
 EDIT\_GetSelText, **1359**  
 EDIT\_GetText, **1360**  
 EDIT\_GetTextAlign, **1361**  
 EDIT\_GetTextColor, **1362**  
 EDIT\_GetUserData, **1363**  
 EDIT\_GetValue, **1364**  
 EDIT\_SetBinMode, **1365**, 2744, 2745  
 EDIT\_SetBkColor, **1366**  
 EDIT\_SetCursorAtChar, **1367**  
 EDIT\_SetCursorAtPixel, **1368**  
 EDIT\_SetDecMode, **1369**  
 EDIT\_SetDefaultBkColor, **1370**  
 EDIT\_SetDefaultFont, **1371**  
 EDIT\_SetDefaultTextAlign, **1372**  
 EDIT\_SetDefaultTextColor, **1373**  
 EDIT\_SetFloatMode, **1374**  
 EDIT\_SetFloatValue, **1375**  
 EDIT\_SetFont, **1377**  
 EDIT\_SetHexMode, **1378**, 2744, 2745  
 EDIT\_SetInsertMode, **1379**  
 EDIT\_SetMaxLen, **1380**  
 EDIT\_SetPasswordChar, **1381**  
 EDIT\_SetPasswordMode, **1382**  
 EDIT\_SetpfAddKeyEx, **1383**  
 EDIT\_SetSel, **1384**, 1384, 1384, 1384  
 EDIT\_SetText, **1385**, 2744, 2744, 2745, 2745  
 EDIT\_SetTextAlign, **1386**, 2744, 2745  
 EDIT\_SetTextColor, **1387**  
 EDIT\_SetTextMode, **1388**  
 EDIT\_SetUlongMode, **1390**  
 EDIT\_SetUserData, **1391**  
 EDIT\_SetValue, **1389**  
 FRAMEWIN\_AddButton, **1400**  
 FRAMEWIN\_AddCloseButton, **1401**  
 FRAMEWIN\_AddMaxButton, **1402**  
 FRAMEWIN\_AddMenu, **1403**  
 FRAMEWIN\_AddMinButton, **1404**  
 FRAMEWIN\_Create, **1405**  
 FRAMEWIN\_CreateAsChild, **1406**  
 FRAMEWIN\_CreateEx, **1407**



FRAMEWIN\_CreateIndirect, 973, **1408**, 2743, 3191  
FRAMEWIN\_CreateUser, **1409**  
FRAMEWIN\_DrawSkinFlex, 2805, 2805  
FRAMEWIN\_GetActive, **1410**  
FRAMEWIN\_GetBarColor, **1411**  
FRAMEWIN\_GetBorderSize, **1412**  
FRAMEWIN\_GetDefaultBarColor, **1413**  
FRAMEWIN\_GetDefaultBorderSize, **1414**  
FRAMEWIN\_GetDefaultClientColor, **1415**  
FRAMEWIN\_GetDefaultFont, **1416**  
FRAMEWIN\_GetDefaultTextColor, **1417**  
FRAMEWIN\_GetDefaultTitleHeight, **1418**  
FRAMEWIN\_GetFont, **1419**, 1442  
FRAMEWIN\_GetText, **1420**, 1442, 2805  
FRAMEWIN\_GetTextAlign, **1421**, 1442  
FRAMEWIN\_GetTitleHeight, **1422**  
FRAMEWIN\_GetUserData, **1423**  
FRAMEWIN\_IsMaximized, **1425**  
FRAMEWIN\_IsMinimized, **1424**  
FRAMEWIN\_Maximize, **1426**  
FRAMEWIN\_Minimize, **1427**  
FRAMEWIN\_OwnerDraw, **1428**, 1442  
FRAMEWIN\_Restore, **1429**  
FRAMEWIN\_SetActive, **1430**  
FRAMEWIN\_SetBarColor, **1431**  
FRAMEWIN\_SetBorderSize, **1432**  
FRAMEWIN\_SetClientColor, **1433**  
FRAMEWIN\_SetDefaultBarColor, **1434**  
FRAMEWIN\_SetDefaultBorderSize, **1435**  
FRAMEWIN\_SetDefaultClientColor, **1436**  
FRAMEWIN\_SetDefaultFont, **1437**  
FRAMEWIN\_SetDefaultTextColor, **1438**  
FRAMEWIN\_SetDefaultTitleHeight, **1439**  
FRAMEWIN\_SetFont, **1440**, 3192  
FRAMEWIN\_SetMoveable, **1441**  
FRAMEWIN\_SetOwnerDraw, **1442**, 1442  
FRAMEWIN\_SetResizeable, **1444**  
FRAMEWIN\_SetSkin, 2805  
FRAMEWIN\_SetSkinFlexProps, **2833**  
FRAMEWIN\_SetText, **1445**, 2746, 2746  
FRAMEWIN\_SetTextAlign, **1446**, 3192  
FRAMEWIN\_SetTextColor, **1447**  
FRAMEWIN\_SetTextColorEx, **1448**  
FRAMEWIN\_SetTitleHeight, **1449**  
FRAMEWIN\_SetTitleVis, **1450**  
FRAMEWIN\_SetUserData, **1451**  
GAUGE\_CreateIndirect, **1459**  
GAUGE\_CreateUser, **1460**  
GAUGE\_EnableCCW, **1461**  
GAUGE\_GetArcPositions, **1462**  
GAUGE\_GetRange, **1464**  
GAUGE\_GetValue, **1463**  
GAUGE\_SetAlign, **1465**  
GAUGE\_SetBkColor, **1466**  
GAUGE\_SetColor, **1467**  
GAUGE\_SetOffset, **1468**  
GAUGE\_SetRadius, **1469**  
GAUGE\_SetRange, **1470**  
GAUGE\_SetRoundedEnd, **1471**  
GAUGE\_SetRoundedValue, **1472**  
GAUGE\_SetValue, **1473**  
GAUGE\_SetValueRange, **1474**  
GAUGE\_SetWidth, **1475**  
GRAPH\_AttachData, 1478, **1483**  
GRAPH\_AttachScale, 1478, **1484**  
GRAPH\_CreateEx, 1478, **1485**, 1505, 1529  
GRAPH\_CreateIndirect, **1486**  
GRAPH\_CreateUser, **1487**  
GRAPH\_DATA\_XY\_AddPoint, **1518**  
GRAPH\_DATA\_XY\_Clear, **1519**  
GRAPH\_DATA\_XY\_Create, **1520**, 1529  
GRAPH\_DATA\_XY\_Delete, **1521**  
GRAPH\_DATA\_XY\_GetLineVis, **1522**  
GRAPH\_DATA\_XY\_GetPoint, **1523**  
GRAPH\_DATA\_XY\_GetPointVis, **1524**  
GRAPH\_DATA\_XY\_SetColor, **1525**

GRAPH\_DATA\_XY\_SetLineStyle, **1526**  
 GRAPH\_DATA\_XY\_SetLineVis, **1527**  
 GRAPH\_DATA\_XY\_SetOffX, **1528**, 1528  
 GRAPH\_DATA\_XY\_SetOffY, **1528**, 1528  
 GRAPH\_DATA\_XY\_SetOwnerDraw, **1529**, 1529  
 GRAPH\_DATA\_XY\_SetPenSize, **1530**  
 GRAPH\_DATA\_XY\_SetPointVis, **1531**  
 GRAPH\_DATA\_YT\_AddValue, **1509**  
 GRAPH\_DATA\_YT\_Clear, **1510**  
 GRAPH\_DATA\_YT\_Create, 1478, **1511**  
 GRAPH\_DATA\_YT\_Delete, **1512**  
 GRAPH\_DATA\_YT\_GetValue, **1513**  
 GRAPH\_DATA\_YT\_MirrorX, **1514**  
 GRAPH\_DATA\_YT\_SetAlign, **1515**  
 GRAPH\_DATA\_YT\_SetColor, **1516**  
 GRAPH\_DATA\_YT\_SetOffY, **1517**, 1517  
 GRAPH\_DetachData, **1488**  
 GRAPH\_DetachScale, **1489**  
 GRAPH\_GetColor, **1490**  
 GRAPH\_GetScrollValue, **1491**  
 GRAPH\_GetUserData, **1492**  
 GRAPH\_InvertScrollbar, **1493**  
 GRAPH\_SCALE\_Create, 1478, **1532**  
 GRAPH\_SCALE\_Delete, **1533**  
 GRAPH\_SCALE\_SetFactor, **1534**  
 GRAPH\_SCALE\_SetFont, **1535**  
 GRAPH\_SCALE\_SetNumDecs, **1536**  
 GRAPH\_SCALE\_SetOff, **1537**  
 GRAPH\_SCALE\_SetPos, **1538**  
 GRAPH\_SCALE\_SetTextColor, **1539**  
 GRAPH\_SCALE\_SetTickDist, **1540**  
 GRAPH\_SetAutoScrollbar, **1494**  
 GRAPH\_SetBorder, **1495**  
 GRAPH\_SetColor, **1496**  
 GRAPH\_SetGridDistX, **1497**  
 GRAPH\_SetGridDistY, **1497**  
 GRAPH\_SetGridFixedX, **1498**  
 GRAPH\_SetGridOffX, **1499**  
 GRAPH\_SetGridOffY, **1500**  
 GRAPH\_SetGridVis, **1501**  
 GRAPH\_SetLineStyleH, **1502**  
 GRAPH\_SetLineStyleV, **1502**  
 GRAPH\_SetScrollValue, **1503**  
 GRAPH\_SetUserData, **1504**  
 GRAPH\_SetUserDraw, **1505**, 1506  
 GRAPH\_SetVSizeX, **1507**  
 GRAPH\_SetVSizeY, **1507**  
 GUI\_\_memcpy, 138  
 GUI\_AA\_DisableHiRes, **2885**, 2915  
 GUI\_AA\_DrawArc, **2891**  
 GUI\_AA\_DrawCircle, **2892**  
 GUI\_AA\_DrawLine, 2881, **2893**, 2910, 2910, 2912  
 GUI\_AA\_DrawPie, **2894**  
 GUI\_AA\_DrawPolyOutline, **2895**, 2895  
 GUI\_AA\_DrawRoundedFrame, **2896**  
 GUI\_AA\_DrawRoundedFrameEx, **2897**  
 GUI\_AA\_DrawRoundedRect, **2898**, 2898  
 GUI\_AA\_DrawRoundedRectEx, **2899**  
 GUI\_AA\_EnableGammaAA4, **2907**  
 GUI\_AA\_EnableHiRes, **2886**, 2912, 2915  
 GUI\_AA\_FillCircle, **2900**, 2949  
 GUI\_AA\_FillEllipse, **2901**  
 GUI\_AA\_FillEllipseXL, **2902**  
 GUI\_AA\_FillPolygon, **2903**, 2914, 2914  
 GUI\_AA\_FillRoundedRect, **2904**, 2904  
 GUI\_AA\_FillRoundedRectEx, **2905**  
 GUI\_AA\_GetFactor, **2887**  
 GUI\_AA\_GetGammaAA4, **2908**  
 GUI\_AA\_SetBufferSize, **2889**  
 GUI\_AA\_SetDrawMode, **2906**  
 GUI\_AA\_SetFactor, **2890**, 2910, 2910, 2912, 2915  
 GUI\_AA\_SetFuncDrawArc, **176**  
 GUI\_AA\_SetFuncDrawCircle, **173**  
 GUI\_AA\_SetFuncDrawLine, **174**  
 GUI\_AA\_SetFuncDrawPolyOutline, **175**  
 GUI\_AA\_SetFuncFillCircle, **171**

GUI\_AA\_SetFuncFillPolygon, **172**  
 GUI\_AA\_SetGammaAA4, **2909**  
 GUI\_AA\_SetpfDrawCharAA4, **163**  
 GUI\_AddRect, **318**, 2221  
 GUI\_ALLOC\_AssignMemory, **114**, 115  
 GUI\_ALLOC\_GetMaxUsedBytes, **183**  
 GUI\_ALLOC\_GetMemInfo, **185**  
 GUI\_ALLOC\_GetNumFreeBytes, **184**  
 GUI\_ALLOC\_GetNumUsedBytes, **186**  
 GUI\_AlphaEnableFillRectHW, **157**  
 GUI\_ANIM\_AddItem, 753, 755, **759**  
 GUI\_ANIM\_AddItemById, **760**  
 GUI\_ANIM\_Create, 753, 756, 757, **761**  
 GUI\_ANIM\_CreateWithId, **762**  
 GUI\_ANIM\_Delete, **763**  
 GUI\_ANIM\_DeleteAll, **764**  
 GUI\_ANIM\_DeleteById, **765**  
 GUI\_ANIM\_Exec, **766**, 766  
 GUI\_ANIM\_Get, **767**  
 GUI\_ANIM\_GetData, **768**  
 GUI\_ANIM\_GetFirst, **769**  
 GUI\_ANIM\_GetItemData, **770**  
 GUI\_ANIM\_GetNext, **771**  
 GUI\_ANIM\_GetNumItems, **772**  
 GUI\_ANIM\_GetPeriod, **773**  
 GUI\_ANIM\_IsRunning, **774**  
 GUI\_ANIM\_Start, **775**  
 GUI\_ANIM\_StartEx, 756, 757, **776**  
 GUI\_ANIM\_StartExId, **777**  
 GUI\_ANIM\_Stop, **778**  
 GUI\_ANIM\_StopById, **779**  
 GUI\_AssignCursorLayer, **3239**  
 GUI\_AttachKerning, 666, **720**  
 GUI\_BARCODE\_Draw, **407**, 407, 407  
 GUI\_BARCODE\_GetXSize, **409**  
 GUI\_BDF\_CreateFont, **687**  
 GUI\_BDF\_DeleteFont, **688**  
 GUI\_BDF\_EmboldenFont, **689**  
 GUI\_BDF\_EmboldenFontEx, **690**  
 GUI\_BDF\_GetFamilyName, **691**  
 GUI\_BDF\_GetStyleName, **692**  
 GUI\_BDF\_SetLetterSpacing, **693**  
 GUI\_BlendColors, **651**  
 GUI\_BMP\_Draw, **449**  
 GUI\_BMP\_DrawEx, **450**  
 GUI\_BMP\_DrawScaled, **451**  
 GUI\_BMP\_DrawScaledEx, **452**  
 GUI\_BMP\_EnableAlpha, **453**  
 GUI\_BMP\_GetXSize, **454**  
 GUI\_BMP\_GetXSizeEx, **455**  
 GUI\_BMP\_GetYSize, **456**  
 GUI\_BMP\_GetYSizeEx, **457**  
 GUI\_BMP\_Serialize, **458**, 458  
 GUI\_BMP\_SerializeEx, **459**  
 GUI\_BMP\_SerializeExBpp, **460**  
 GUI\_Clear, 235, 251, 299, 300, 325, **327**, 327, 355, 358, 391, 393, 395, 403, 609, 788, 964, 974, 974, 999,  
 1007, 1060, 1066, 1083, 1083, 1149, 1149, 1150, 2898, 2904, 2910, 2912, 2928, 2929, 2949, 2949, 2950,  
 2955, 2965, 3004, 3226, 3226, 3230, 3231  
 GUI\_ClearKeyBuffer, **891**  
 GUI\_ClearRect, **328**, 2914, 2914  
 GUI\_Color2Index, **652**  
 GUI\_Color2VisColor, **653**  
 GUI\_ColorIsAvailable, **654**  
 GUI\_CopyRect, **329**  
 GUI\_CreateBitmapFromStream, **367**, 367  
 GUI\_CreateDialogBox, 973, **2747**, 3193  
 GUI\_CURSOR\_GetState, **3082**  
 GUI\_CURSOR\_Hide, **3083**  
 GUI\_CURSOR\_Select, **3084**  
 GUI\_CURSOR\_SelectAnim, **3085**  
 GUI\_CURSOR\_SetPosition, **3086**  
 GUI\_CURSOR\_Show, **3087**  
 GUI\_DCACHE\_Clear, **148**  
 GUI\_DCACHE\_SetClearCacheHook, **149**  
 GUI\_Delay, 256, 327, 340, 396, 403, 756, 789, 900, **944**, 974, 974, 1008, 1066, 1149, 1150, 1150, 1150,  
 2911, 2912, 2915, 2929, 2950, 3002, 3020, 3194, 3226, 3228



GUI\_DrawLine, 251, 251, **381**, 458, 2910, 2919, 2928, 2928, 2950, 2980, 3004, 3005  
 GUI\_DrawLineRel, **382**  
 GUI\_DrawLineTo, **383**  
 GUI\_DrawPie, **416**, 416  
 GUI\_DrawPieHR, **417**  
 GUI\_DrawPixel, **342**  
 GUI\_DrawPoint, **343**, 403, 3020  
 GUI\_DrawPolygon, **390**  
 GUI\_DrawPolyLine, **384**  
 GUI\_DrawRect, **344**, 1529  
 GUI\_DrawRectEx, **345**, 2955  
 GUI\_DrawRoundedFrame, **346**  
 GUI\_DrawRoundedFrameEx, **347**  
 GUI\_DrawRoundedRect, **348**  
 GUI\_DrawRoundedRectEx, **349**  
 GUI\_DrawStreamedBitmap, **371**  
 GUI\_DrawStreamedBitmapAuto, **372**  
 GUI\_DrawStreamedBitmapEx, **373**  
 GUI\_DrawStreamedBitmapExAuto, **374**  
 GUI\_DrawVLine, **385**  
 GUI\_EMSCRIPTEN\_GetNow, **247**  
 GUI\_EMSCRIPTEN\_GetNowTimezone, **248**  
 GUI\_EnableAlpha, 355, 355, **356**, 358  
 GUI\_EndDialog, 2745, 2745, 2746, 2746, **2750**  
 GUI\_EnlargePolygon, **391**, 391  
 GUI\_ErrorOut, **951**  
 GUI\_Exec, **945**, 1109, 3197, 3201, 3206  
 GUI\_Exec1, **946**  
 GUI\_ExecCreatedDialog, **2748**  
 GUI\_ExecDialogBox, 2743, **2749**  
 GUI\_Exit, **106**  
 GUI\_FillCircle, 325, 325, 359, **398**, 398, 3230, 3231  
 GUI\_FillEllipse, **401**, 401, 401  
 GUI\_FillPolygon, 391, 391, **392**, 393, 395  
 GUI\_FillRect, **350**, 355, 355, 355, 358, 358, 358, 3092, 3092, 3092, 3226, 3230, 3230, 3230, 3230, 3230  
 GUI\_FillRectEx, 265, 266, **351**  
 GUI\_FillRoundedRect, **352**  
 GUI\_FillRoundedRectEx, **353**  
 GUI\_FT\_DestroyCache, **694**  
 GUI\_FT\_Done, **695**  
 GUI\_FT\_GetMeasurementChars, **696**  
 GUI\_FT\_SetCacheSize, **697**  
 GUI\_FT\_SetMeasurementChars, **698**  
 GUI\_GCACHE\_Create, 140, **142**  
 GUI\_GCACHE\_CreateEx, **143**  
 GUI\_GCACHE\_CreateUserEx, 141, **144**  
 GUI\_GetBkColor, **635**  
 GUI\_GetBkColorIndex, **636**  
 GUI\_GetCharDistX, **699**  
 GUI\_GetCharFromPos, **269**  
 GUI\_GetClientRect, 264, **319**  
 GUI\_GetClipRect, **320**  
 GUI\_GetColor, **637**  
 GUI\_GetColorIndex, **638**  
 GUI\_GetDefaultBkColor, **640**  
 GUI\_GetDefaultColor, **639**  
 GUI\_GetDefaultFont, **700**  
 GUI\_GetDispPosX, **284**  
 GUI\_GetDispPosY, **285**  
 GUI\_GetDrawMode, **321**  
 GUI\_GetFallbackFont, **701**  
 GUI\_GetFont, **702**  
 GUI\_GetFontDistY, **703**  
 GUI\_GetFontInfo, **704**, 704  
 GUI\_GetFontSizeY, **705**  
 GUI\_GetKey, **892**  
 GUI\_GetKeyPressed, **893**  
 GUI\_GetKeyState, **894**  
 GUI\_GetLayerPosEx, **3240**  
 GUI\_GetLeadingBlankCols, **706**  
 GUI\_GetLeadingBlankRows, **707**  
 GUI\_GetLineStyle, **386**  
 GUI\_GetOrg, **3096**  
 GUI\_GetPenSize, **322**  
 GUI\_GetPixelIndex, **323**  
 GUI\_GetShowMissingCharacters, **270**

GUI\_GetStreamedBitmapInfo, **376**  
 GUI\_GetStreamedBitmapInfoEx, **377**  
 GUI\_GetStringDistX, **708**  
 GUI\_GetStringDistXEx, **709**  
 GUI\_GetTextAlign, **279**  
 GUI\_GetTextExtend, **710**  
 GUI\_GetTextMode, **275**  
 GUI\_GetTime, **947**  
 GUI\_GetTimeSlice, **948**  
 GUI\_GetTrailingBlankCols, **711**  
 GUI\_GetTrailingBlankRows, **712**  
 GUI\_GetVersionString, **310**, 310  
 GUI\_GetYDistOfFont, **713**  
 GUI\_GetYSizeOfFont, **714**  
 GUI\_GIF\_Draw, **477**  
 GUI\_GIF\_DrawEx, **478**  
 GUI\_GIF\_DrawSub, **479**  
 GUI\_GIF\_DrawSubEx, **480**  
 GUI\_GIF\_DrawSubScaled, **481**  
 GUI\_GIF\_DrawSubScaledEx, **482**  
 GUI\_GIF\_GetComment, **483**  
 GUI\_GIF\_GetCommentEx, **484**  
 GUI\_GIF\_GetImageInfo, **485**  
 GUI\_GIF\_GetImageInfoEx, **486**  
 GUI\_GIF\_GetInfo, **487**  
 GUI\_GIF\_GetInfoEx, **488**  
 GUI\_GIF\_GetXSize, **489**  
 GUI\_GIF\_GetXSizeEx, **490**  
 GUI\_GIF\_GetYSize, **491**  
 GUI\_GIF\_GetYSizeEx, **492**  
 GUI\_GotoX, **283**, 300, 300, 300, 300, 300  
 GUI\_GotoXY, **283**, 283, 1083, 1083  
 GUI\_GotoY, **283**  
 GUI\_Index2Color, **655**  
 GUI\_Init, **104**, 108, 108, 235, 299, 340, 361, 396, 406, 458, 462, 788, 900, 974, 1007, 1066, 1150, 1529, 1577, 2898, 2904, 2911, 2912, 2915, 2928, 2949, 2955, 2965, 2980, 2983, 3002, 3019, 3020, 3043, 3193, 3197, 3226, 3491  
 GUI\_InvertRect, **354**  
 GUI\_IsInFont, **715**, 715  
 GUI\_IsInitialized, **105**  
 GUI\_JPEG\_Draw, 462, **465**, 2942  
 GUI\_JPEG\_DrawEx, **466**  
 GUI\_JPEG\_DrawScaled, **467**  
 GUI\_JPEG\_DrawScaledEx, **468**  
 GUI\_JPEG\_GetInfo, **469**  
 GUI\_JPEG\_GetInfoEx, **470**  
 GUI\_JPEG\_SetpfDrawEx, **181**  
 GUI\_JPEG\_SetpfWritePixels, **471**  
 GUI\_LANG\_Clear, **923**  
 GUI\_LANG\_GetLang, **924**  
 GUI\_LANG\_GetNumItems, **925**  
 GUI\_LANG\_GetText, **926**  
 GUI\_LANG\_GetTextBuffered, **927**  
 GUI\_LANG\_GetTextBufferedEx, **928**  
 GUI\_LANG\_GetTextEx, **929**  
 GUI\_LANG\_GetTextLen, **930**  
 GUI\_LANG\_GetTextLenEx, **931**  
 GUI\_LANG\_LoadCSV, **921**  
 GUI\_LANG\_LoadCSVEx, **922**  
 GUI\_LANG\_LoadText, **918**  
 GUI\_LANG\_LoadTextEx, **919**  
 GUI\_LANG\_SetLang, **932**  
 GUI\_LANG\_SetMaxNumLang, **933**  
 GUI\_LANG\_SetSep, **934**  
 GUI\_Log, **952**  
 GUI\_MagnifyPolygon, **393**, 393  
 GUI\_MATRIX\_Equals, **527**  
 GUI\_MATRIX\_GetCellPtr, **528**  
 GUI\_MATRIX\_Identity, 521, **530**  
 GUI\_MATRIX\_Initialize, **529**, 529  
 GUI\_MATRIX\_Multiply, **531**  
 GUI\_MATRIX\_MultiplyPoint, **532**  
 GUI\_MATRIX\_Rotate, 521, **533**  
 GUI\_MATRIX\_Scale, 521, **534**  
 GUI\_MATRIX\_Shear, **535**  
 GUI\_MATRIX\_Translate, **536**

GUI\_MBITMAP\_Create, 3002, **3008**  
 GUI\_MBITMAP\_CreateEx, **3009**  
 GUI\_MBITMAP\_CreateUser, 3005, **3010**  
 GUI\_MBITMAP\_CreateUserEx, **3011**  
 GUI\_MBITMAP\_Delete, **3012**  
 GUI\_MBITMAP\_SetColorFormat, **3013**  
 GUI\_MEASDEV\_ClearRect, **2976**  
 GUI\_MEASDEV\_Create, **2977**, 2980  
 GUI\_MEASDEV\_Delete, **2978**, 2980  
 GUI\_MEASDEV\_GetRect, **2979**, 2980  
 GUI\_MEASDEV\_Select, **2980**, 2980  
 GUI\_MEMDEV\_BlendColor32, **2990**  
 GUI\_MEMDEV\_BlendWinBk, **2998**  
 GUI\_MEMDEV\_BlurAndBlendWinBk, **2999**  
 GUI\_MEMDEV\_BlurWinBk, **3000**  
 GUI\_MEMDEV\_Clear, **2927**  
 GUI\_MEMDEV\_ClearAlpha, **2928**, 2929  
 GUI\_MEMDEV\_CopyFromLCD, **2930**  
 GUI\_MEMDEV\_CopyRect, **2931**  
 GUI\_MEMDEV\_CopyToLCD, 2919, **2932**, 2965  
 GUI\_MEMDEV\_CopyToLCDAA, **2933**, 2933  
 GUI\_MEMDEV\_CopyToLCDat, **2934**, 2942, 2942, 2942, 2955, 2955  
 GUI\_MEMDEV\_Create, 2919, 2933, **2935**, 2965, 2965  
 GUI\_MEMDEV\_CreateAuto, 2915, **2972**, 2975  
 GUI\_MEMDEV\_CreateBlurredDevice32, **2991**  
 GUI\_MEMDEV\_CreateBlurredDevice32HQ, **2993**  
 GUI\_MEMDEV\_CreateBlurredDevice32LQ, **2994**  
 GUI\_MEMDEV\_CreateCopy, **2936**  
 GUI\_MEMDEV\_CreateEx, **2937**  
 GUI\_MEMDEV\_CreateFixed, 2928, 2929, **2938**, 2938, 2942, 2942, 2942, 2949  
 GUI\_MEMDEV\_CreateFixed32, **2939**, 2950, 2955, 2955  
 GUI\_MEMDEV\_Delete, **2940**  
 GUI\_MEMDEV\_DeleteAuto, **2973**, 2975  
 GUI\_MEMDEV\_Dither32, **2995**  
 GUI\_MEMDEV\_Draw, **2970**  
 GUI\_MEMDEV\_DrawAuto, 2915, 2915, **2974**, 2975  
 GUI\_MEMDEV\_DrawPerspectiveX, **2941**, 2942, 2942  
 GUI\_MEMDEV\_FadeInDevices, **2981**  
 GUI\_MEMDEV\_FadeInWindow, **2985**  
 GUI\_MEMDEV\_FadeOutDevices, **2982**  
 GUI\_MEMDEV\_FadeOutWindow, **2985**  
 GUI\_MEMDEV\_GetBitsPerPixel, **2943**  
 GUI\_MEMDEV\_GetDataPtr, **2944**  
 GUI\_MEMDEV\_GetSelMemdev, **2945**  
 GUI\_MEMDEV\_GetXSize, **2946**  
 GUI\_MEMDEV\_GetYSize, **2947**  
 GUI\_MEMDEV\_MarkDirty, **2948**  
 GUI\_MEMDEV\_MoveInWindow, **2986**  
 GUI\_MEMDEV\_MoveOutWindow, **2986**  
 GUI\_MEMDEV\_MULTIBUF\_Enable, **3001**  
 GUI\_MEMDEV\_PunchOutDevice, **2949**, 2950  
 GUI\_MEMDEV\_ReduceYSize, **2951**  
 GUI\_MEMDEV\_Select, 2919, 2919, 2928, 2928, 2929, 2929, 2933, 2938, 2942, 2942, 2942, 2949, 2950,  
 2950, 2955, 2955, 2955, **2956**, 2965, 2965  
 GUI\_MEMDEV\_SerializeBMP, **2957**  
 GUI\_MEMDEV\_SerializeExBMP, **2958**  
 GUI\_MEMDEV\_SetAnimationCallback, **2983**, 2983  
 GUI\_MEMDEV\_SetBlendFunc, **179**  
 GUI\_MEMDEV\_SetBlurHQ, **2996**  
 GUI\_MEMDEV\_SetBlurLQ, **2997**  
 GUI\_MEMDEV\_SetDrawMemdev16bppFunc, **165**  
 GUI\_MEMDEV\_SetOrg, **2959**  
 GUI\_MEMDEV\_SetTimePerFrame, **2984**  
 GUI\_MEMDEV\_ShiftInWindow, **2988**  
 GUI\_MEMDEV\_ShiftOutWindow, **2988**  
 GUI\_MEMDEV\_SwapWindow, **2989**  
 GUI\_MEMDEV\_Write, 2929, 2950, **2960**  
 GUI\_MEMDEV\_WriteAlpha, **2961**  
 GUI\_MEMDEV\_WriteAlphaAt, **2962**  
 GUI\_MEMDEV\_WriteAt, **2963**  
 GUI\_MEMDEV\_WriteEx, **2964**  
 GUI\_MEMDEV\_WriteExAt, **2965**, 2965  
 GUI\_MEMDEV\_WriteOpaque, **2966**  
 GUI\_MEMDEV\_WriteOpaqueAt, **2967**  
 GUI\_MessageBox, **2798**  
 GUI\_MOUSE\_DRIVER\_PS2\_Init, **827**

GUI\_MOUSE\_DRIVER\_PS2\_OnRx, 826, **828**  
 GUI\_MOUSE\_GetState, **824**  
 GUI\_MOUSE\_StoreState, **825**, 825  
 GUI\_MoveRel, **387**  
 GUI\_MoveTo, **388**  
 GUI\_MOVIE\_Create, **793**  
 GUI\_MOVIE\_CreateEx, 789, **794**  
 GUI\_MOVIE\_Delete, **795**  
 GUI\_MOVIE\_DrawFrame, **796**  
 GUI\_MOVIE\_GetFrameIndex, **797**  
 GUI\_MOVIE\_GetInfo, **798**  
 GUI\_MOVIE\_GetInfoEx, 789, **799**  
 GUI\_MOVIE\_GetInfoH, **800**  
 GUI\_MOVIE\_GetNumFrames, **801**  
 GUI\_MOVIE\_GetPos, **802**  
 GUI\_MOVIE\_GotoFrame, **803**  
 GUI\_MOVIE\_IsPlaying, **804**  
 GUI\_MOVIE\_Pause, **805**  
 GUI\_MOVIE\_Play, **806**  
 GUI\_MOVIE\_SetPeriod, **807**  
 GUI\_MOVIE\_SetpfNotify, **808**  
 GUI\_MOVIE\_SetPos, **809**  
 GUI\_MOVIE\_SetSecondHandle, **810**  
 GUI\_MOVIE\_Show, 789, **811**  
 GUI\_MTOUCH\_Enable, 3019, 3020, **3025**  
 GUI\_MTOUCH\_GetEvent, 3020, **3026**  
 GUI\_MTOUCH\_GetTouchInput, 3020, **3027**  
 GUI\_MTOUCH\_IsEmpty, **3028**  
 GUI\_MTOUCH\_SetOrientation, **3029**  
 GUI\_MTOUCH\_StoreEvent, **3030**  
 GUI\_MULTIBUF\_Begin, 756, 788, **876**  
 GUI\_MULTIBUF\_BeginEx, **877**  
 GUI\_MULTIBUF\_Config, 871, 871, **878**  
 GUI\_MULTIBUF\_ConfigEx, **879**  
 GUI\_MULTIBUF\_Confirm, 873, 874, **880**  
 GUI\_MULTIBUF\_ConfirmEx, **881**  
 GUI\_MULTIBUF\_End, 756, 788, **882**  
 GUI\_MULTIBUF\_EndEx, **883**  
 GUI\_MULTIBUF\_GetNumBuffers, **884**  
 GUI\_MULTIBUF\_GetNumBuffersEx, **885**  
 GUI\_MULTIBUF\_UseSingleBuffer, **886**  
 GUI\_PID\_GetCurrentState, **816**  
 GUI\_PID\_GetState, **817**, 817, 853  
 GUI\_PID\_IsEmpty, **818**  
 GUI\_PID\_IsPressed, **819**  
 GUI\_PID\_SetHook, **820**  
 GUI\_PID\_StoreState, **821**, 854  
 GUI\_PNG\_Draw, **497**, 3004  
 GUI\_PNG\_GetXSize, **499**, 3004  
 GUI\_PNG\_GetYSize, **501**, 3004  
 GUI\_PreserveTrans, **357**  
 GUI\_QR\_Create, **411**  
 GUI\_QR\_CreateFramed, **412**  
 GUI\_QR\_Delete, **413**  
 GUI\_QR\_Draw, **414**  
 GUI\_QR\_GetInfo, **415**  
 GUI\_RegisterAfterInitHook, **115**, 115, 115  
 GUI\_RestoreUserAlpha, **358**, 358  
 GUI\_RotatePolygon, **395**, 395, 2915, 2915  
 GUI\_SelectLayer, 2919, 2919, 3226, 3230, 3230, 3231, **3241**  
 GUI\_SelectLCD, **2968**, 2980  
 GUI\_SendKeyMsg, **889**  
 GUI\_SetAfterExitHook, **188**  
 GUI\_SetAfterInitHook, **189**  
 GUI\_SetAlphaMask8888, **364**  
 GUI\_SetBkColor, 251, 251, 355, 358, 395, 403, 407, 609, **641**, 964, 974, 974, 1007, 1060, 1066, 1083,  
 1083, 1149, 2898, 2904, 2910, 2912, 2928, 2949, 2949, 2950, 2965, 3004, 3226, 3226, 3230, 3231  
 GUI\_SetBkColorIndex, **642**  
 GUI\_SetBlendBkColor, **643**  
 GUI\_SetBlendBkColorEx, **644**  
 GUI\_SetBlendColor, **645**  
 GUI\_SetBlendColorEx, **646**  
 GUI\_SetClearTextRectMode, **276**  
 GUI\_SetClipRect, **324**, 324, 324



GUI\_SetColor, 235, 251, 251, 266, 266, 355, 355, 355, 355, 358, 358, 358, 358, 359, 359, 359, 393, 395,  
 395, 401, 401, 401, 403, 407, 416, **647**, 1083, 1083, 1442, 2730, 2805, 2898, 2904, 2910, 2912, 2949,  
 2950, 2955, 3004, 3092, 3092, 3092, 3092, 3226, 3226, 3230, 3230, 3230, 3230, 3231, 3231  
 GUI\_SetColorIndex, **648**  
 GUI\_SetControlHook, **190**  
 GUI\_SetDefaultBkColor, **650**  
 GUI\_SetDefaultColor, **649**  
 GUI\_SetDefaultFont, 115, **716**  
 GUI\_SetDrawMode, **325**, 325, 325, 391, 2949  
 GUI\_SetFallbackFont, **717**  
 GUI\_SetFont, 236, 251, 299, 300, 359, 395, 403, 676, 676, **718**, 718, 718, 718, 718, 718, 718, 900, 1442,  
 2933, 2955  
 GUI\_SetFuncDrawA8, **160**  
 GUI\_SetFuncDrawAlpha, **159**  
 GUI\_SetFuncDrawBitmapEx, **177**  
 GUI\_SetFuncDrawCircle, **167**  
 GUI\_SetFuncDrawLine, **170**  
 GUI\_SetFuncDrawM565, **156**  
 GUI\_SetFuncDrawRoundedRect, **169**  
 GUI\_SetFuncFillCircle, **166**  
 GUI\_SetFuncFillRoundedRect, **168**  
 GUI\_SetFuncGetFallbackFont, **719**  
 GUI\_SetFuncGetpPalConvTable, **164**  
 GUI\_SetLayerAlphaEx, **3242**  
 GUI\_SetLayerPosEx, **3243**  
 GUI\_SetLayerSizeEx, **3244**  
 GUI\_SetLayerVisEx, **3245**  
 GUI\_SetLBorder, **280**, 2912  
 GUI\_SetLineStyle, **389**  
 GUI\_SetOnErrorFunc, **116**  
 GUI\_SetOnLogFunc, **117**  
 GUI\_SetOnWarnFunc, **118**  
 GUI\_SetOrg, 3092, 3092, **3097**  
 GUI\_SetOrientation, **3278**  
 GUI\_SetOrientationEx, **3279**  
 GUI\_SetPenSize, 251, **326**, 403, 403, 403, 2898, 2910, 2910, 2912, 2928, 2950, 3004, 3020  
 GUI\_SetpfMemcpy, **132**  
 GUI\_SetpfMemset, **133**  
 GUI\_SetpfStrcmp, **134**  
 GUI\_SetpfStrcpy, **135**  
 GUI\_SetpfStrlen, **136**  
 GUI\_SetRefreshHook, **191**  
 GUI\_SetSignalEventFunc, **3203**, 3203  
 GUI\_SetStreamedBitmapHook, **378**  
 GUI\_SetTextAlign, **281**, 281, 403  
 GUI\_SetTextMode, 251, 251, 251, 251, 251, 265, 266, **277**, 359, 403, 1442, 2955, 2965, 3092, 3226  
 GUI\_SetTextStyle, **278**  
 GUI\_SetTimeSlice, **949**  
 GUI\_SetUserAlpha, 358, **360**  
 GUI\_SetWaitEventFunc, **3204**, 3204  
 GUI\_SetWaitEventTimedFunc, **3205**, 3205  
 GUI\_ShowMissingCharacters, **271**  
 GUI\_SIF\_CreateFont, **671**, 671, 672  
 GUI\_SIF\_DeleteFont, **672**, 672  
 GUI\_SOFTLAYER\_Enable, 3237, **3247**  
 GUI\_SOFTLAYER\_MULTIBUF\_Enable, **3250**  
 GUI\_SOFTLAYER\_Refresh, **3248**  
 GUI\_SOFTLAYER\_SetCompositeColor, **3249**  
 GUI\_SPLINE\_Create, **418**  
 GUI\_SPLINE\_Delete, **419**  
 GUI\_SPLINE\_Draw, **420**  
 GUI\_SPLINE\_DrawAA, **421**  
 GUI\_SPLINE\_GetXSize, **423**  
 GUI\_SPLINE\_GetY, **422**  
 GUI\_SPRITE\_Create, **3064**  
 GUI\_SPRITE\_CreateAnim, **3065**  
 GUI\_SPRITE\_CreateEx, **3066**  
 GUI\_SPRITE\_CreateExAnim, **3067**  
 GUI\_SPRITE\_CreateHidden, **3068**  
 GUI\_SPRITE\_CreateHiddenEx, **3069**  
 GUI\_SPRITE\_Delete, **3070**  
 GUI\_SPRITE\_GetState, **3071**  
 GUI\_SPRITE\_Hide, **3072**  
 GUI\_SPRITE\_SetBitmap, **3073**  
 GUI\_SPRITE\_SetBitmapAndPosition, **3074**  
 GUI\_SPRITE\_SetLoop, **3075**

GUI\_SPRITE\_SetPosition, **3076**  
 GUI\_SPRITE\_Show, **3077**  
 GUI\_SPRITE\_StartAnim, **3078**  
 GUI\_SPRITE\_StopAnim, **3079**  
 GUI\_SPY\_Process, **3169**, 3169  
 GUI\_SPY\_SetMemHandler, **3170**  
 GUI\_SPY\_StartServer, **3171**  
 GUI\_SPY\_StartServerEx, **3172**  
 GUI\_SPY\_X\_StartServer, **3163**  
 GUI\_StoreKey, **895**  
 GUI\_StoreKeyMsg, **888**  
 GUI\_SVG\_Create, 520, 521, 522, **551**  
 GUI\_SVG\_CreateEx, **552**  
 GUI\_SVG\_Delete, **553**  
 GUI\_SVG\_Draw, 508, **543**  
 GUI\_SVG\_DrawEx, **544**  
 GUI\_SVG\_DrawH, 520, 521, 522, **554**  
 GUI\_SVG\_DrawScaled, **545**  
 GUI\_SVG\_DrawScaledEx, **546**  
 GUI\_SVG\_DrawScaledRotated, 520, **547**  
 GUI\_SVG\_DrawScaledRotatedEx, **548**  
 GUI\_SVG\_DRIVER\_BindAPI, 507, 509, 510, 512, 513, 515, 518, **573**  
 GUI\_SVG\_DRIVER\_BindDynamicAPI, 511, 513, 516, 519, **574**  
 GUI\_SVG\_DRIVER\_GetSelected, **575**  
 GUI\_SVG\_DRIVER\_HasBoundAPI, 507, 509, **576**  
 GUI\_SVG\_DRIVER\_NanoVG, 603  
 GUI\_SVG\_DRIVER\_NemaVG, 603  
 GUI\_SVG\_DRIVER\_OpenVG, 603  
 GUI\_SVG\_DRIVER\_Select, 507, 509, 510, 511, 512, 513, 513, 515, 516, 518, 519, **577**  
 GUI\_SVG\_DRIVER\_SetHooks, 507, **578**  
 GUI\_SVG\_DRIVER\_SetVersion, 507, 509, 515, 516, **579**  
 GUI\_SVG\_DRIVER\_VGLite, 603  
 GUI\_SVG\_Enable, 508, **566**  
 GUI\_SVG\_EnableBMP, 507, **570**  
 GUI\_SVG\_EnableCacheMode, 522, **555**  
 GUI\_SVG\_EnableGIF, 507, **569**  
 GUI\_SVG\_EnableJPEG, 507, **568**  
 GUI\_SVG\_EnablePNG, 507, **567**  
 GUI\_SVG\_GetInfo, **549**  
 GUI\_SVG\_GetInfoEx, **550**  
 GUI\_SVG\_GetInfoH, **556**  
 GUI\_SVG\_Identity, **557**  
 GUI\_SVG\_Render, 522, **558**  
 GUI\_SVG\_Rotate, 520, **559**  
 GUI\_SVG\_RotateEx, **560**  
 GUI\_SVG\_Scale, 520, 520, 520, **561**  
 GUI\_SVG\_ScaleToSize, **562**  
 GUI\_SVG\_SetBkColor, 522, **563**  
 GUI\_SVG\_SetDPI, **571**  
 GUI\_SVG\_SetFileBufferSize, **572**  
 GUI\_SVG\_Transform, 521, **564**  
 GUI\_SVG\_Translate, 520, **565**  
 GUI\_TIMER\_Create, **955**  
 GUI\_TIMER\_Delete, **956**  
 GUI\_TIMER\_Restart, **957**  
 GUI\_TIMER\_SetPeriod, **958**  
 GUI\_TOUCH\_CalcCoefficients, **849**  
 GUI\_TOUCH\_Calibrate, 835, 835, **841**, 845, 845  
 GUI\_TOUCH\_CalibratePoint, **850**  
 GUI\_TOUCH\_EnableCalibration, **851**  
 GUI\_TOUCH\_Exec, **842**  
 GUI\_TOUCH\_GetState, **830**  
 GUI\_TOUCH\_GetxPhys, **843**  
 GUI\_TOUCH\_GetyPhys, **843**  
 GUI\_TOUCH\_SetOrientation, 835, **844**, 845  
 GUI\_TOUCH\_StoreState, **831**, 831  
 GUI\_TOUCH\_StoreStateEx, **832**, 832  
 GUI\_TOUCH\_TransformPoint, **852**  
 GUI\_TTF\_AddRowBottom, **673**  
 GUI\_TTF\_AddRowTop, **674**  
 GUI\_TTF\_CreateFont, **675**, 675, 676  
 GUI\_TTF\_CreateFontAA, **677**  
 GUI\_TTF\_EmboldenFont, **678**  
 GUI\_TTF\_EmboldenFontEx, **679**  
 GUI\_TTF\_EnableKerning, **680**  
 GUI\_TTF\_GetFamilyName, **681**

GUI\_TTF\_GetStyleName, **682**  
 GUI\_TTF\_ObliqueFont, **683**  
 GUI\_TTF\_ObliqueFontEx, **684**  
 GUI\_UC\_ConvertUC2UTF8, **902**  
 GUI\_UC\_ConvertUTF82UC, **903**  
 GUI\_UC\_DispString, **914**  
 GUI\_UC\_EnableBIDI, **904**, 940  
 GUI\_UC\_EnableThai, **905**  
 GUI\_UC\_Encode, **906**  
 GUI\_UC\_GetBaseDir, **907**  
 GUI\_UC\_GetCharCode, **908**, 909, 909  
 GUI\_UC\_GetCharSize, **909**, 909  
 GUI\_UC\_SetBaseDir, **910**  
 GUI\_UC\_SetEncodeNone, **912**  
 GUI\_UC\_SetEncodesJIS, **911**  
 GUI\_UC\_SetEncodeUTF8, 899, 899, 900, **913**  
 GUI\_VNC\_AttachToLayer, **3045**  
 GUI\_VNC\_EnableFileTransfer, **3046**  
 GUI\_VNC\_EnableKeyboardInput, **3047**  
 GUI\_VNC\_GetNumConnections, **3048**  
 GUI\_VNC\_Process, **3049**, 3049  
 GUI\_VNC\_RingBell, **3050**  
 GUI\_VNC\_SetFS\_API, **3051**  
 GUI\_VNC\_SetLockFrame, **3052**  
 GUI\_VNC\_SetPassword, **3053**  
 GUI\_VNC\_SetProgName, **3054**  
 GUI\_VNC\_SetRetryCount, **3055**  
 GUI\_VNC\_SetSize, **3056**  
 GUI\_VNC\_X\_StartServer, 3043, **3057**  
 GUI\_VNC\_X\_StartServerFT, **3058**  
 GUI\_WaitEvent, **3206**, 3206  
 GUI\_WaitKey, **896**  
 GUI\_Warn, **953**  
 GUI\_WrapGetNumLines, **272**  
 GUI\_WrapGetPositions, **273**  
 GUI\_WrapSetSeparators, **274**  
 GUI\_X\_Delay, **127**, 766  
 GUI\_X\_ExecIdle, **128**, 3201  
 GUI\_X\_GetTaskId, **3210**, 3217, 3217, 3218  
 GUI\_X\_GetTime, **129**  
 GUI\_X\_Init, **126**  
 GUI\_X\_InitOS, **3211**, 3217, 3217, 3218  
 GUI\_X\_Lock, **3212**, 3217, 3217, 3218  
 GUI\_X\_SignalEvent, 3203, 3208, **3213**, 3217, 3217  
 GUI\_X\_Unlock, **3214**, 3217, 3217, 3218  
 GUI\_X\_WaitEvent, 3204, 3208, **3215**, 3217, 3217  
 GUI\_X\_WaitEventTimed, 3205, 3208, **3216**, 3217  
 GUI\_XBF\_CreateFont, **685**, 728  
 GUI\_XBF\_DeleteFont, **686**  
 GUI\_YUV\_Create, **424**  
 GUI\_YUV\_CreateEx, **425**  
 GUI\_YUV\_Delete, **426**  
 GUI\_YUV\_DeleteEx, **427**  
 GUI\_YUV\_GetpData, **428**  
 GUI\_YUV\_GetpDataEx, **429**  
 GUI\_YUV\_InvalidateArea, **430**  
 GUI\_YUV\_SetPeriod, **431**  
 GUI\_YUV\_SetPeriodEx, **432**  
 GUICC\_M1555I\_SetCustColorConv, **155**  
 GUICC\_M4444I\_SetCustColorConv, **155**  
 GUICC\_M565\_SetCustColorConv, **155**  
 GUICC\_M8888I\_SetCustColorConv, **155**  
 GUICC\_M888\_SetCustColorConv, **155**  
 GUIDRV\_BitPlains\_Config, **3288**  
 GUIDRV\_Dist\_AddDriver, 3289, 3289, **3290**, 3290, 3290  
 GUIDRV\_FlexColor\_Config, 3293, **3299**  
 GUIDRV\_FlexColor\_SetFunc, 3294, **3295**  
 GUIDRV\_FlexColor\_SetOrientation, **3300**  
 GUIDRV\_FlexColor\_SetReadFunc66709\_B16, **3303**  
 GUIDRV\_FlexColor\_SetReadFunc66720\_B16, **3308**  
 GUIDRV\_FlexColor\_SetReadFunc66772\_B16, **3310**  
 GUIDRV\_FlexColor\_SetReadFunc66772\_B8, **3309**  
 GUIDRV\_IST3088\_SetBus16, **3313**  
 GUIDRV\_Lin\_SetThreshold, **3318**  
 GUIDRV\_S1D13513\_Config, **3328**  
 GUIDRV\_S1D13513\_SetBus16, **3329**

GUIDRV\_S1D13748\_Config, **3332**  
 GUIDRV\_S1D13748\_SetBus16, **3333**  
 GUIDRV\_S1D13781\_Config, **3337**  
 GUIDRV\_S1D13781\_SetBusSPI, **3338**  
 GUIDRV\_S1D13781\_SetOrientation, **3339**  
 GUIDRV\_S1D13C00\_Config, **3323**  
 GUIDRV\_S1D13C00\_SetBaseAddress, **3324**  
 GUIDRV\_S1D13C00\_SetBus, **3325**  
 GUIDRV\_S1D13L01\_Config, **3337**  
 GUIDRV\_S1D13L01\_SetBusSPI, **3338**  
 GUIDRV\_S1D13L01\_SetOrientation, **3339**  
 GUIDRV\_S1D13L02\_Config, **3332**  
 GUIDRV\_S1D13L02\_SetBus16, **3333**  
 GUIDRV\_S1D13L04\_Config, **3328**  
 GUIDRV\_S1D13L04\_SetBus16, **3329**  
 GUIDRV\_S1D15G00\_Config, **3343**, 3344  
 GUIDRV\_S1D15G00\_SetBus8, **3344**, 3344  
 GUIDRV\_SH\_MEM\_3\_Config, **3348**  
 GUIDRV\_SH\_MEM\_3\_SetBus8, **3349**  
 GUIDRV\_SH\_MEM\_Config, **3348**, 3350  
 GUIDRV\_SH\_MEM\_SetBus8, **3349**, 3350  
 GUIDRV\_SLin\_Config, 3260, 3361  
 GUIDRV\_SLin\_SetBus8, 3261, 3361  
 GUIDRV\_SLin\_SetS1D13700, 3261, **3356**, 3361  
 GUIDRV\_SLin\_SetSSD1325, **3357**  
 GUIDRV\_SLin\_SetSSD1848, **3358**  
 GUIDRV\_SLin\_SetT6963, **3359**  
 GUIDRV\_SLin\_SetUC1617, **3360**  
 GUIDRV\_SLinEPD\_Config, **3365**, 3371  
 GUIDRV\_SLinEPD\_EnableFastMode, **3366**  
 GUIDRV\_SLinEPD\_EnablePartialMode, **3367**  
 GUIDRV\_SLinEPD\_SetBus8, **3368**, 3371  
 GUIDRV\_SLinEPD\_SetSSD1673, **3369**, 3371  
 GUIDRV\_SLinEPD\_SetUC8451, **3370**  
 GUIDRV\_SPage\_Config, **3376**, 3388  
 GUIDRV\_SPage\_Set1502, **3378**  
 GUIDRV\_SPage\_Set1510, **3379**  
 GUIDRV\_SPage\_Set1512, **3380**  
 GUIDRV\_SPage\_SetBus8, **3377**, 3388  
 GUIDRV\_SPage\_SetST75256, **3381**  
 GUIDRV\_SPage\_SetST75320, **3382**  
 GUIDRV\_SPage\_SetST7591, **3383**  
 GUIDRV\_SPage\_SetUC1610, **3384**  
 GUIDRV\_SPage\_SetUC1611, **3385**, 3388  
 GUIDRV\_SPage\_SetUC1628, **3386**  
 GUIDRV\_SPage\_SetUC1638, **3387**  
 GUIDRV\_SSD1322\_Config, **3390**, 3392  
 GUIDRV\_SSD1322\_SetBus8, **3391**, 3392  
 GUIDRV\_SSD1926\_Config, **3395**, 3397  
 GUIDRV\_SSD1926\_SetBus16, **3396**, 3397  
 GUIDRV\_UC1698G\_Config, **3400**  
 GUIDRV\_UC1698G\_SetBus16, **3402**  
 GUIDRV\_UC1698G\_SetBus8, **3401**  
 GUIMTDRV\_TangoC32\_Init, **3467**  
 GUITASK\_GetMaxTask, **119**  
 GUITASK\_SetMaxTask, **120**  
 GUITDRV\_ADS7846\_Config, **3470**  
 GUITDRV\_ADS7846\_Exec, **3472**  
 GUITDRV\_ADS7846\_GetLastVal, **3473**  
 HEADER\_AddItem, **1551**, 1577, 1577  
 HEADER\_Create, **1552**, 1577  
 HEADER\_CreateAttached, **1553**  
 HEADER\_CreateEx, **1554**  
 HEADER\_CreateIndirect, **1555**  
 HEADER\_CreateUser, **1556**  
 HEADER\_DeleteItem, **1557**  
 HEADER\_GetBkColor, **1558**  
 HEADER\_GetBorderH, **1559**  
 HEADER\_GetBorderV, **1560**  
 HEADER\_GetColumnFromPos, **1561**  
 HEADER\_GetDefaultBkColor, **1562**  
 HEADER\_GetDefaultBorderH, **1563**  
 HEADER\_GetDefaultBorderV, **1564**  
 HEADER\_GetDefaultCursor, **1565**  
 HEADER\_GetDefaultFont, **1566**  
 HEADER\_GetDefaultTextColor, **1567**

HEADER\_GetFont, **1568**  
 HEADER\_GetHeight, **1569**  
 HEADER\_GetItemText, **1570**  
 HEADER\_GetItemWidth, **1571**  
 HEADER\_GetNumItems, **1572**  
 HEADER\_GetSel, **1573**  
 HEADER\_GetTextColor, **1574**  
 HEADER\_GetUserData, **1575**  
 HEADER\_SetBitmap, **1576**  
 HEADER\_SetBitmapEx, **1577**, 1577, 1577  
 HEADER\_SetBkColor, **1578**  
 HEADER\_SetBMP, **1579**  
 HEADER\_SetBMPEX, **1580**  
 HEADER\_SetBorderH, **1581**  
 HEADER\_SetBorderV, **1582**  
 HEADER\_SetDefaultBkColor, **1583**  
 HEADER\_SetDefaultBorderH, **1584**  
 HEADER\_SetDefaultBorderV, **1585**  
 HEADER\_SetDefaultCursor, **1586**  
 HEADER\_SetDefaultFont, 1577, **1587**  
 HEADER\_SetDefaultTextColor, 1577, **1588**  
 HEADER\_SetDragLimit, **1589**  
 HEADER\_SetFixed, **1590**  
 HEADER\_SetFont, **1591**  
 HEADER\_SetHeight, **1592**  
 HEADER\_SetItemText, **1593**  
 HEADER\_SetItemWidth, **1594**  
 HEADER\_SetScrollPos, **1595**  
 HEADER\_SetSkinFlexProps, **2838**  
 HEADER\_SetStreamedBitmap, **1596**  
 HEADER\_SetStreamedBitmapEx, **1597**  
 HEADER\_SetTextAlign, **1598**  
 HEADER\_SetTextColor, **1599**, 1809  
 HEADER\_SetUserData, **1600**  
 ICONVIEW\_AddBitmapItem, **1606**  
 ICONVIEW\_AddStreamedBitmapItem, **1607**  
 ICONVIEW\_CreateEx, **1608**  
 ICONVIEW\_CreateIndirect, **1609**  
 ICONVIEW\_CreateUser, **1610**  
 ICONVIEW\_DeleteItem, **1611**  
 ICONVIEW\_GetBkColor, **1613**  
 ICONVIEW\_GetFont, **1614**  
 ICONVIEW\_GetItemBitmap, **1615**  
 ICONVIEW\_GetItemText, **1616**  
 ICONVIEW\_GetItemUserData, **1617**  
 ICONVIEW\_GetNumItems, **1618**  
 ICONVIEW\_GetReleasedItem, **1619**  
 ICONVIEW\_GetSel, **1620**  
 ICONVIEW\_GetTextColor, **1621**  
 ICONVIEW\_GetUserData, **1622**  
 ICONVIEW\_InsertBitmapItem, **1623**  
 ICONVIEW\_InsertStreamedBitmapItem, **1624**  
 ICONVIEW\_OwnerDraw, **1625**, 1633  
 ICONVIEW\_SetBitmapItem, **1626**  
 ICONVIEW\_SetBkColor, **1627**  
 ICONVIEW\_SetFont, **1628**  
 ICONVIEW\_SetFrame, **1629**  
 ICONVIEW\_SetIconAlign, **1630**  
 ICONVIEW\_SetItemText, **1631**  
 ICONVIEW\_SetItemUserData, **1632**  
 ICONVIEW\_SetOwnerDraw, **1633**  
 ICONVIEW\_SetSel, **1634**  
 ICONVIEW\_SetSpace, **1635**  
 ICONVIEW\_SetStreamedBitmapItem, **1636**  
 ICONVIEW\_SetTextAlign, **1637**  
 ICONVIEW\_SetTextColor, **1638**  
 ICONVIEW\_SetUserData, **1639**  
 ICONVIEW\_SetWrapMode, **1640**  
 IMAGE\_CreateEx, **1647**, 3002  
 IMAGE\_CreateIndirect, **1648**  
 IMAGE\_CreateUser, **1649**  
 IMAGE\_EnableLQ, **1650**  
 IMAGE\_GetImageSize, **1651**  
 IMAGE\_GetUserData, **1652**  
 IMAGE\_SetAlign, **1653**  
 IMAGE\_SetAlpha, **1654**

IMAGE\_SetAngle, **1655**  
 IMAGE\_SetBitmap, **1656**, 3002  
 IMAGE\_SetBMP, **1657**  
 IMAGE\_SetBMPEX, **1658**  
 IMAGE\_SetDTA, **1657**  
 IMAGE\_SetDTAEx, **1658**  
 IMAGE\_SetGIF, **1657**  
 IMAGE\_SetGIFEx, **1658**  
 IMAGE\_SetJPEG, **1657**  
 IMAGE\_SetJPEGEx, **1658**  
 IMAGE\_SetOffset, **1659**  
 IMAGE\_SetPNG, **1657**  
 IMAGE\_SetPNGEx, **1658**  
 IMAGE\_SetScale, **1660**  
 IMAGE\_SetTiled, **1661**  
 IMAGE\_SetUserData, **1662**  
 KEYBOARD\_CreateIndirect, **1672**  
 KEYBOARD\_CreateUser, **1671**  
 KEYBOARD\_ExportLayout, **1673**, 1673  
 KEYBOARD\_ExportPatternFile, **1674**  
 KEYBOARD\_GetDefaultColor, **1675**  
 KEYBOARD\_GetDefaultFrameSize, **1676**  
 KEYBOARD\_GetDefaultPeriod, **1677**  
 KEYBOARD\_GetDefaultRadius, **1678**  
 KEYBOARD\_GetDefaultSpace, **1679**  
 KEYBOARD\_GetKeyRect, **1680**  
 KEYBOARD\_LockShiftState, **1681**  
 KEYBOARD\_SetColor, **1684**  
 KEYBOARD\_SetDefaultColor, **1685**  
 KEYBOARD\_SetDefaultFrameSize, **1686**  
 KEYBOARD\_SetDefaultPeriod, **1687**  
 KEYBOARD\_SetDefaultRadius, **1688**  
 KEYBOARD\_SetDefaultSpace, **1689**  
 KEYBOARD\_SetFont, **1690**  
 KEYBOARD\_SetLayout, **1682**, 1682  
 KEYBOARD\_SetPeriod, **1691**  
 KEYBOARD\_SetRadius, **1692**  
 KEYBOARD\_SetShiftState, **1693**  
 KEYBOARD\_SetSpace, **1694**  
 KEYBOARD\_SetStreamedLayout, **1683**, 1683, 1683  
 KNOB\_AddValue, **2681**  
 KNOB\_CreateEx, **2682**  
 KNOB\_CreateIndirect, **2683**  
 KNOB\_CreateUser, **2684**  
 KNOB\_GetUserData, **2685**  
 KNOB\_GetValue, **2686**  
 KNOB\_SetBkColor, **2687**  
 KNOB\_SetBkDevice, **2688**  
 KNOB\_SetDevice, **2689**  
 KNOB\_SetInvert, **2690**  
 KNOB\_SetKeyValue, **2691**  
 KNOB\_SetOffset, **2692**  
 KNOB\_SetPeriod, **2693**  
 KNOB\_SetPos, **2694**  
 KNOB\_SetRange, **2695**  
 KNOB\_SetRotateHQ, **2696**  
 KNOB\_SetRotateLQ, **2696**  
 KNOB\_SetSnap, **2697**  
 KNOB\_SetTickSize, **2698**  
 KNOB\_SetUserData, **2699**  
 LCD\_ControlCache, 244, 244, **3464**  
 LCD\_GetBitsPerPixel, **3428**  
 LCD\_GetBitsPerPixelEx, **3429**  
 LCD\_GetMirrorX, 835  
 LCD\_GetMirrorXEx, 845  
 LCD\_GetMirrorY, 835  
 LCD\_GetMirrorYEx, 845  
 LCD\_GetNumColors, **3430**  
 LCD\_GetNumColorsEx, **3431**  
 LCD\_GetNumLayers, **3246**  
 LCD\_GetPosEx, **3432**  
 LCD\_GetSwapXY, 835, 3288, 3350, 3371, 3388, 3392  
 LCD\_GetSwapXYEx, 845  
 LCD\_GetVRAMAddr, **3433**  
 LCD\_GetVRAMAddrEx, **3434**  
 LCD\_GetVXSize, **3435**

LCD\_GetVXSizeEx, **3436**  
 LCD\_GetVYSize, **3435**  
 LCD\_GetVYSizeEx, **3436**  
 LCD\_GetXMag, **3437**  
 LCD\_GetXMagEx, **3438**  
 LCD\_GetXSize, 853, 2219, **3439**  
 LCD\_GetXSizeEx, **3440**  
 LCD\_GetYMag, **3437**  
 LCD\_GetYMagEx, **3438**  
 LCD\_GetYSize, 853, 2219, **3439**  
 LCD\_GetYSizeEx, **3440**  
 LCD\_OffEx, **3450**  
 LCD\_On, **3451**  
 LCD\_OnEx, **3452**  
 LCD\_Refresh, **3453**  
 LCD\_RefreshEx, **3454**  
 LCD\_ROTATE\_AddDriver, **3268**  
 LCD\_ROTATE\_AddDriverEx, **3269**  
 LCD\_ROTATE\_DecSel, **3270**  
 LCD\_ROTATE\_DecSelEx, **3271**  
 LCD\_ROTATE\_IncSel, **3272**  
 LCD\_ROTATE\_IncSelEx, **3273**  
 LCD\_ROTATE\_SetCallback, **3274**  
 LCD\_ROTATE\_SetSel, **3275**  
 LCD\_ROTATE\_SetSelEx, **3276**  
 LCD\_SetAlphaEx, **3441**  
 LCD\_SetAlphaModeEx, **3442**  
 LCD\_SetBufferPtr, **3447**, 3447  
 LCD\_SetBufferPtrEx, 872, **3448**  
 LCD\_SetChromaEx, **3443**  
 LCD\_SetChromaModeEx, **3444**  
 LCD\_SetDevFunc, 872, **3455**  
 LCD\_SetLUT, **630**  
 LCD\_SetLUTEntryEx, **632**  
 LCD\_SetLUTEx, 629, **631**, 3229  
 LCD\_SetMaxNumColors, **3460**  
 LCD\_SetPosEx, **3445**  
 LCD\_SetSizeEx, 122, 3092, 3232, 3232, 3234, 3234, 3237, 3260, 3288, 3288, 3290, 3293, 3319, 3344, 3350, 3350, 3361, 3371, 3371, 3388, 3388, 3392, 3392, 3396, 3408, **3461**  
 LCD\_SetVisEx, **3446**  
 LCD\_SetVRAMAddrEx, 122, 3232, 3232, 3234, 3237, 3288, 3319, **3462**  
 LCD\_SetVSizeEx, 122, **3091**, 3092, 3237, 3260, 3288, 3288, 3290, 3293, 3319, 3344, 3361, 3371, 3371, 3388, 3388, 3392, 3392, 3396, **3091**  
 LISTBOX\_AddString, **1711**  
 LISTBOX\_Clear, **1712**  
 LISTBOX\_Create, **1713**, 2189  
 LISTBOX\_CreateAsChild, **1714**  
 LISTBOX\_CreateEx, **1715**  
 LISTBOX\_CreateIndirect, **1716**, 2743  
 LISTBOX\_CreateUser, **1717**  
 LISTBOX\_DecSel, **1718**  
 LISTBOX\_DeleteItem, **1719**  
 LISTBOX\_EnableMotion, **1720**  
 LISTBOX\_EnableWrapMode, **1721**  
 LISTBOX\_GetBkColor, **1722**  
 LISTBOX\_GetDefaultBkColor, **1723**  
 LISTBOX\_GetDefaultFont, **1724**  
 LISTBOX\_GetDefaultScrollStepH, **1725**  
 LISTBOX\_GetDefaultTextAlign, **1726**  
 LISTBOX\_GetDefaultTextColor, **1727**  
 LISTBOX\_GetFixedScrollPos, **1728**  
 LISTBOX\_GetFont, **1729**  
 LISTBOX\_GetItemDisabled, **1730**  
 LISTBOX\_GetItemSel, **1731**  
 LISTBOX\_GetItemSpacing, **1732**  
 LISTBOX\_GetItemText, **1733**  
 LISTBOX\_GetMulti, **1734**  
 LISTBOX\_GetNumItems, **1735**  
 LISTBOX\_GetOwner, **1736**  
 LISTBOX\_GetScrollStepH, **1737**  
 LISTBOX\_GetSel, **1738**  
 LISTBOX\_GetTextAlign, **1739**  
 LISTBOX\_GetTextColor, **1740**  
 LISTBOX\_GetUserData, **1741**  
 LISTBOX\_GetVisItemIndices, **1742**  
 LISTBOX\_IncSel, **1743**

LISTBOX\_InsertString, **1744**  
 LISTBOX\_InvalidItem, **1745**  
 LISTBOX\_IsItemPartiallyVisible, **1746**  
 LISTBOX\_OwnerDraw, **1747**, 1762, 1762  
 LISTBOX\_SetAutoScrollH, **1748**  
 LISTBOX\_SetAutoScrollV, **1749**  
 LISTBOX\_SetBkColor, **1750**  
 LISTBOX\_SetDefaultBkColor, **1751**  
 LISTBOX\_SetDefaultFont, **1752**  
 LISTBOX\_SetDefaultScrollStepH, **1753**  
 LISTBOX\_SetDefaultTextAlign, **1754**  
 LISTBOX\_SetDefaultTextColor, **1755**  
 LISTBOX\_SetFixedScrollPos, **1756**  
 LISTBOX\_SetFont, **1757**  
 LISTBOX\_SetItemDisabled, **1758**  
 LISTBOX\_SetItemSel, **1759**  
 LISTBOX\_SetItemSpacing, **1760**  
 LISTBOX\_SetMulti, **1761**  
 LISTBOX\_SetOwnerDraw, **1762**  
 LISTBOX\_SetScrollbarColor, **1764**  
 LISTBOX\_SetScrollbarWidth, **1765**  
 LISTBOX\_SetScrollStepH, **1766**  
 LISTBOX\_SetSel, **1767**  
 LISTBOX\_SetString, **1768**  
 LISTBOX\_SetText, 2744, 2745  
 LISTBOX\_SetTextAlign, **1769**  
 LISTBOX\_SetTextColor, **1770**  
 LISTBOX\_SetUserData, **1771**  
 LISTVIEW\_AddColumn, **1781**  
 LISTVIEW\_AddRow, **1782**  
 LISTVIEW\_Clear, **1783**  
 LISTVIEW\_CompareDec, **1784**  
 LISTVIEW\_CompareText, **1785**  
 LISTVIEW\_Create, **1786**, 1809  
 LISTVIEW\_CreateAttached, **1787**  
 LISTVIEW\_CreateEx, **1788**, 2219  
 LISTVIEW\_CreateIndirect, **1789**  
 LISTVIEW\_CreateUser, **1790**  
 LISTVIEW\_DecSel, **1791**  
 LISTVIEW\_DeleteAllRows, **1792**  
 LISTVIEW\_DeleteColumn, **1793**  
 LISTVIEW\_DeleteRow, **1794**  
 LISTVIEW\_DisableRow, **1795**  
 LISTVIEW\_DisableSort, **1796**  
 LISTVIEW\_EnableCellSelect, **1797**  
 LISTVIEW\_EnableMotion, **1798**, 2219  
 LISTVIEW\_EnableRow, **1799**  
 LISTVIEW\_EnableSort, **1800**  
 LISTVIEW\_GetBkColor, **1801**  
 LISTVIEW\_GetDefaultBkColor, **1802**  
 LISTVIEW\_GetDefaultFont, **1803**  
 LISTVIEW\_GetDefaultGridColor, **1804**  
 LISTVIEW\_GetDefaultScrollStepH, **1805**  
 LISTVIEW\_GetDefaultTextColor, **1806**  
 LISTVIEW\_GetFont, **1807**  
 LISTVIEW\_GetGridColor, **1808**  
 LISTVIEW\_GetHeader, **1809**, 1809  
 LISTVIEW\_GetItemRect, **1810**  
 LISTVIEW\_GetItemText, **1811**  
 LISTVIEW\_GetItemTextLen, **1812**  
 LISTVIEW\_GetItemTextSorted, **1813**  
 LISTVIEW\_GetLBorder, **1814**  
 LISTVIEW\_GetNumColumns, **1815**  
 LISTVIEW\_GetNumRows, **1816**  
 LISTVIEW\_GetOverlap, **1817**  
 LISTVIEW\_GetRBorder, **1818**  
 LISTVIEW\_GetScrollStepH, **1819**  
 LISTVIEW\_GetSel, **1820**  
 LISTVIEW\_GetSelCol, **1821**  
 LISTVIEW\_GetSelUnsorted, **1822**  
 LISTVIEW\_GetTextAlign, **1823**  
 LISTVIEW\_GetTextColor, **1824**  
 LISTVIEW\_GetUserData, **1825**  
 LISTVIEW\_GetUserDataRow, **1826**  
 LISTVIEW\_GetVisRowIndices, **1827**  
 LISTVIEW\_GetWrapMode, **1828**



LISTVIEW\_IncSel, **1829**  
 LISTVIEW\_InsertRow, **1830**  
 LISTVIEW\_IsRowPartiallyVisible, **1831**  
 LISTVIEW\_OwnerDraw, **1832**  
 LISTVIEW\_RowIsDisabled, **1833**  
 LISTVIEW\_SetAutoScrollH, **1834**  
 LISTVIEW\_SetAutoScrollV, **1835**  
 LISTVIEW\_SetBkColor, **1836**  
 LISTVIEW\_SetColumnWidth, **1837**  
 LISTVIEW\_SetCompareFunc, **1838**, 1838  
 LISTVIEW\_SetDefaultBkColor, **1840**  
 LISTVIEW\_SetDefaultFont, **1841**  
 LISTVIEW\_SetDefaultGridColor, **1842**  
 LISTVIEW\_SetDefaultScrollStepH, **1843**  
 LISTVIEW\_SetDefaultTextColor, **1844**  
 LISTVIEW\_SetFixed, **1845**  
 LISTVIEW\_SetFont, **1846**  
 LISTVIEW\_SetGridVis, **1847**  
 LISTVIEW\_SetHeaderHeight, **1848**  
 LISTVIEW\_SetItemBitmap, **1849**  
 LISTVIEW\_SetItemBkColor, **1850**  
 LISTVIEW\_SetItemText, **1851**  
 LISTVIEW\_SetItemTextColor, **1852**  
 LISTVIEW\_SetItemTextSorted, **1853**  
 LISTVIEW\_SetLBorder, **1854**  
 LISTVIEW\_SetOverlap, **1855**  
 LISTVIEW\_SetOwnerDraw, **1856**  
 LISTVIEW\_SetRBorder, **1857**  
 LISTVIEW\_SetRowHeight, **1858**  
 LISTVIEW\_SetScrollPos, **1859**  
 LISTVIEW\_SetScrollStepH, **1860**  
 LISTVIEW\_SetSel, **1861**  
 LISTVIEW\_SetSelCol, **1862**  
 LISTVIEW\_SetSelUnsorted, **1863**  
 LISTVIEW\_SetSort, **1864**  
 LISTVIEW\_SetTextAlign, **1865**  
 LISTVIEW\_SetTextColor, **1866**  
 LISTVIEW\_SetUserData, **1867**  
 LISTVIEW\_SetUserDataRow, **1868**  
 LISTVIEW\_SetWrapMode, **1869**  
 LISTWHEEL\_AddString, **2704**  
 LISTWHEEL\_CreateEx, **2705**, 2705  
 LISTWHEEL\_CreateIndirect, **2706**  
 LISTWHEEL\_CreateUser, **2707**  
 LISTWHEEL\_GetBkColor, **2708**  
 LISTWHEEL\_GetFont, **2709**  
 LISTWHEEL\_GetItemFromPos, **2710**  
 LISTWHEEL\_GetItemText, **2711**  
 LISTWHEEL\_GetLBorder, **2712**  
 LISTWHEEL\_GetLineHeight, **2713**  
 LISTWHEEL\_GetNumItems, **2714**  
 LISTWHEEL\_GetPos, **2715**  
 LISTWHEEL\_GetRBorder, **2716**  
 LISTWHEEL\_GetSel, **2717**  
 LISTWHEEL\_GetSnapPosition, **2718**  
 LISTWHEEL\_GetTextAlign, **2719**  
 LISTWHEEL\_GetTextColor, **2720**  
 LISTWHEEL\_GetUserData, **2721**  
 LISTWHEEL\_IsMoving, **2722**  
 LISTWHEEL\_MoveToPos, **2723**  
 LISTWHEEL\_OwnerDraw, **2724**, 2730  
 LISTWHEEL\_SetBkColor, **2725**  
 LISTWHEEL\_SetDeceleration, **2726**  
 LISTWHEEL\_SetFont, **2727**  
 LISTWHEEL\_SetLBorder, **2728**  
 LISTWHEEL\_SetLineHeight, **2729**  
 LISTWHEEL\_SetOwnerDraw, **2730**  
 LISTWHEEL\_SetPos, **2731**  
 LISTWHEEL\_SetRBorder, **2732**  
 LISTWHEEL\_SetSel, **2733**  
 LISTWHEEL\_SetSnapPosition, **2734**  
 LISTWHEEL\_SetText, **2735**, 2735  
 LISTWHEEL\_SetTextAlign, **2736**  
 LISTWHEEL\_SetTextColor, **2737**  
 LISTWHEEL\_SetTimerPeriod, **2738**  
 LISTWHEEL\_SetUserData, **2739**

LISTWHEEL\_SetVelocity, **2740**  
MENU\_AddItem, **1877**  
MENU\_Attach, **1878**  
MENU\_Callback, **1873**  
MENU\_CreateEx, **1879**  
MENU\_CreateIndirect, **1880**  
MENU\_CreateUser, **1881**  
MENU\_DeleteItem, **1882**  
MENU\_DisableItem, **1883**  
MENU\_EnableItem, **1884**  
MENU\_GetBkColor, **1885**  
MENU\_GetDefaultBkColor, **1886**  
MENU\_GetDefaultBorderSize, **1887**  
MENU\_GetDefaultEffect, **1888**  
MENU\_GetDefaultFont, **1889**  
MENU\_GetDefaultTextColor, **1890**  
MENU\_GetFont, **1891**  
MENU\_GetItem, **1892**  
MENU\_GetItemText, **1893**  
MENU\_GetNumItems, **1894**  
MENU\_GetOwner, **1895**  
MENU\_GetTextColor, **1896**  
MENU\_GetUserData, **1897**  
MENU\_InsertItem, **1898**  
MENU\_Popup, **1899**  
MENU\_SetBkColor, **1900**  
MENU\_SetBorderSize, **1901**, 1901, 1901, 1901  
MENU\_SetDefaultBkColor, **1902**  
MENU\_SetDefaultBorderSize, **1903**  
MENU\_SetDefaultEffect, **1904**  
MENU\_SetDefaultFont, **1905**  
MENU\_SetDefaultTextColor, **1906**  
MENU\_SetFont, **1907**  
MENU\_SetItem, **1908**  
MENU\_SetOwner, **1909**  
MENU\_SetSel, **1910**  
MENU\_SetSkinFlexProps, **2844**  
MENU\_SetTextColor, **1911**  
MENU\_SetUserData, **1912**  
MENU\_SkinEnableArrow, **2845**  
MESSAGEBOX\_Create, **2799**  
MOVIE\_CreateUser, **1926**  
MOVIE\_GetBarSize, **1927**  
MOVIE\_GetColor, **1928**  
MOVIE\_GetDefaultColor, **1929**  
MOVIE\_GetDefaultPeriod, **1930**  
MOVIE\_GetDefaultSizeBar, **1931**  
MOVIE\_GetDefaultSizePanel, **1932**  
MOVIE\_GetDefaultSpace, **1933**  
MOVIE\_GetMovie, **1934**  
MOVIE\_GetInfo, **1935**  
MOVIE\_GetPanelSize, **1936**  
MOVIE\_GetPeriod, **1937**  
MOVIE\_GetSpace, **1938**  
MOVIE\_GotoFrame, **1940**  
MOVIE\_Pause, **1941**  
MOVIE\_Play, **1942**  
MOVIE\_SetBarSize, **1943**  
MOVIE\_SetCenterBitmap, **1944**  
MOVIE\_SetColor, **1945**  
MOVIE\_SetColors, **1946**  
MOVIE\_SetData, **1947**  
MOVIE\_SetDataEx, **1948**  
MOVIE\_SetDefaultColor, **1949**  
MOVIE\_SetDefaultPeriod, **1950**  
MOVIE\_SetDefaultSizeBar, **1951**  
MOVIE\_SetDefaultSizePanel, **1952**  
MOVIE\_SetDefaultSpace, **1953**  
MOVIE\_SetPanelBitmaps, **1954**  
MOVIE\_SetPanelSize, **1957**  
MOVIE\_SetPeriod, **1955**  
MOVIE\_SetPeriods, **1956**  
MOVIE\_SetSizes, **1958**  
MOVIE\_SetSpace, **1959**  
MULTIEDIT\_AddKey, **1970**  
MULTIEDIT\_AddText, **1971**

MULTIEDIT\_Create, **1972**  
MULTIEDIT\_CreateEx, **1973**  
MULTIEDIT\_CreateIndirect, **1974**  
MULTIEDIT\_CreateUser, **1975**  
MULTIEDIT\_EnableBlink, **1976**  
MULTIEDIT\_EnableMotion, **1977**  
MULTIEDIT\_GetBkColor, **1978**  
MULTIEDIT\_GetCursorCharPos, **1979**  
MULTIEDIT\_GetCursorPixelPos, **1980**  
MULTIEDIT\_GetDefaultAlign, **1981**  
MULTIEDIT\_GetDefaultBkColor, **1982**  
MULTIEDIT\_GetDefaultCursorColor, **1983**  
MULTIEDIT\_GetDefaultFont, **1984**  
MULTIEDIT\_GetDefaultHBorder, **1985**  
MULTIEDIT\_GetDefaultTextColor, **1986**  
MULTIEDIT\_GetFont, **1987**  
MULTIEDIT\_GetNumChars, **1988**  
MULTIEDIT\_GetPrompt, **1989**  
MULTIEDIT\_GetText, **1990**  
MULTIEDIT\_GetTextColor, **1991**  
MULTIEDIT\_GetTextSize, **1992**  
MULTIEDIT\_GetUserData, **1993**  
MULTIEDIT\_SetAutoScrollH, **1994**  
MULTIEDIT\_SetAutoScrollV, **1995**  
MULTIEDIT\_SetBkColor, **1996**  
MULTIEDIT\_SetBufferSize, **1997**  
MULTIEDIT\_SetCursorCharPos, **1998**  
MULTIEDIT\_SetCursorColor, **1999**  
MULTIEDIT\_SetCursorOffset, **2000**  
MULTIEDIT\_SetCursorPixelPos, **2001**  
MULTIEDIT\_SetDefaultAlign, **2002**  
MULTIEDIT\_SetDefaultBkColor, **2003**  
MULTIEDIT\_SetDefaultCursorColor, **2004**  
MULTIEDIT\_SetDefaultFont, **2005**  
MULTIEDIT\_SetDefaultHBorder, **2006**  
MULTIEDIT\_SetDefaultTextColor, **2007**  
MULTIEDIT\_SetFocusable, **2008**  
MULTIEDIT\_SetFont, **2009**  
MULTIEDIT\_SetHBorder, **2010**  
MULTIEDIT\_SetInsertMode, **2011**  
MULTIEDIT\_SetInvertCursor, **2012**  
MULTIEDIT\_SetMaxNumChars, **2013**  
MULTIEDIT\_SetPasswordMode, **2014**  
MULTIEDIT\_SetPrompt, **2015**  
MULTIEDIT\_SetReadOnly, **2016**  
MULTIEDIT\_SetText, **2017**  
MULTIEDIT\_SetTextAlign, **2018**  
MULTIEDIT\_SetTextColor, **2019**  
MULTIEDIT\_SetUserData, **2020**  
MULTIEDIT\_SetWrapChar, **2021**  
MULTIEDIT\_SetWrapNone, **2022**  
MULTIEDIT\_SetWrapWord, **2023**  
MULTIEDIT\_ShowCursor, **2024**  
MULTIPAGE\_AddEmptyPage, **2035**  
MULTIPAGE\_AddPage, **2036**  
MULTIPAGE\_AttachWindow, **2037**  
MULTIPAGE\_CreateEx, **2038**  
MULTIPAGE\_CreateIndirect, **2039**  
MULTIPAGE\_CreateUser, **2040**  
MULTIPAGE\_DeletePage, **2041**  
MULTIPAGE\_DisablePage, **2042**  
MULTIPAGE\_EnablePage, **2043**  
MULTIPAGE\_EnableScrollbar, **2044**  
MULTIPAGE\_GetBkColor, **2045**  
MULTIPAGE\_GetDefaultAlign, **2046**  
MULTIPAGE\_GetDefaultBkColor, **2047**  
MULTIPAGE\_GetDefaultFont, **2048**  
MULTIPAGE\_GetDefaultTextColor, **2049**  
MULTIPAGE\_GetFont, **2050**  
MULTIPAGE\_GetNumTabs, **2051**  
MULTIPAGE\_GetPageText, **2052**  
MULTIPAGE\_GetSelection, **2053**  
MULTIPAGE\_GetTabHeight, **2054**  
MULTIPAGE\_GetTabWidth, **2055**  
MULTIPAGE\_GetTextColor, **2056**  
MULTIPAGE\_GetUserData, **2057**

MULTIPAGE\_GetWindow, **2058**  
 MULTIPAGE\_IsPageEnabled, **2059**  
 MULTIPAGE\_SelectPage, **2060**  
 MULTIPAGE\_SetAlign, **2061**  
 MULTIPAGE\_SetBitmap, **2062**  
 MULTIPAGE\_SetBitmapEx, **2063**  
 MULTIPAGE\_SetBkColor, **2064**  
 MULTIPAGE\_SetDefaultAlign, **2065**  
 MULTIPAGE\_SetDefaultBkColor, **2066**  
 MULTIPAGE\_SetDefaultBorderSizeX, **2067**  
 MULTIPAGE\_SetDefaultBorderSizeY, **2068**  
 MULTIPAGE\_SetDefaultFont, **2069**  
 MULTIPAGE\_SetDefaultTextColor, **2070**  
 MULTIPAGE\_SetFont, **2071**  
 MULTIPAGE\_SetRotation, **2072**  
 MULTIPAGE\_SetSkinFlexProps, **2850**  
 MULTIPAGE\_SetTabHeight, **2073**  
 MULTIPAGE\_SetTabWidth, **2074**  
 MULTIPAGE\_SetText, **2075**  
 MULTIPAGE\_SetTextAlign, **2076**  
 MULTIPAGE\_SetTextColor, **2077**  
 MULTIPAGE\_SetUserData, **2078**  
 PROGBAR\_Create, 1155, **2087**  
 PROGBAR\_CreateAsChild, **2088**  
 PROGBAR\_CreateEx, **2089**  
 PROGBAR\_CreateIndirect, **2090**  
 PROGBAR\_CreateUser, **2091**  
 PROGBAR\_GetBarColor, **2092**  
 PROGBAR\_GetFont, **2093**  
 PROGBAR\_GetMinMax, **2094**  
 PROGBAR\_GetTextColor, **2095**  
 PROGBAR\_GetUserData, **2096**  
 PROGBAR\_GetValue, **2097**  
 PROGBAR\_SetBarColor, 1156, 1156, **2098**  
 PROGBAR\_SetFont, **2099**  
 PROGBAR\_SetMinMax, **2100**  
 PROGBAR\_SetSkinFlexProps, **2855**  
 PROGBAR\_SetText, **2101**  
 PROGBAR\_SetTextAlign, **2102**  
 PROGBAR\_SetTextColor, **2103**  
 PROGBAR\_SetTextPos, **2104**  
 PROGBAR\_SetUserData, **2105**  
 PROGBAR\_SetValue, 1156, **2106**  
 QRCODE\_CreateIndirect, **2111**  
 QRCODE\_CreateUser, **2112**  
 QRCODE\_SetEccLevel, **2113**  
 QRCODE\_SetPixelSize, **2115**  
 QRCODE\_SetText, **2116**  
 QRCODE\_SetVersion, **2114**  
 QRCODE\_SetWiFiText, **2117**  
 RADIO\_Create, **2123**  
 RADIO\_CreateEx, **2124**, 2148, 2148  
 RADIO\_CreateIndirect, **2125**  
 RADIO\_CreateUser, **2126**  
 RADIO\_Dec, **2127**  
 RADIO\_GetBkColor, **2128**  
 RADIO\_GetDefaultFont, **2129**  
 RADIO\_GetDefaultTextColor, **2130**  
 RADIO\_GetFocusColor, **2131**  
 RADIO\_GetFont, **2132**  
 RADIO\_GetImage, **2133**  
 RADIO\_GetNumItems, **2134**  
 RADIO\_GetSpacing, **2135**  
 RADIO\_GetText, **2136**  
 RADIO\_GetTextColor, **2137**  
 RADIO\_GetUserData, **2138**  
 RADIO\_GetValue, **2139**  
 RADIO\_Inc, **2140**  
 RADIO\_SetBkColor, **2141**  
 RADIO\_SetDefaultFocusColor, **2142**  
 RADIO\_SetDefaultFont, **2143**  
 RADIO\_SetDefaultImage, **2144**  
 RADIO\_SetDefaultTextColor, **2145**  
 RADIO\_SetFocusColor, **2146**  
 RADIO\_SetFont, **2147**  
 RADIO\_SetGroupId, **2148**, 2148, 2148

RADIO\_SetImage, **2149**  
 RADIO\_SetSkinFlexProps, **2860**  
 RADIO\_SetSpacing, **2150**  
 RADIO\_SetText, 2148, 2148, 2148, 2148, 2148, 2148, **2151**, 2151, 2151, 2151  
 RADIO\_SetTextColor, **2152**  
 RADIO\_SetUserData, **2153**  
 RADIO\_SetValue, **2154**  
 ROTARY\_AddAngle, **2160**  
 ROTARY\_AddValue, **2161**  
 ROTARY\_CreateEx, **2162**  
 ROTARY\_CreateIndirect, **2163**  
 ROTARY\_CreateUser, **2164**  
 ROTARY\_GetAngle, **2165**  
 ROTARY\_GetImageSize, **2166**  
 ROTARY\_GetMarkerSize, **2167**  
 ROTARY\_GetUserData, **2168**  
 ROTARY\_GetValue, **2169**  
 ROTARY\_SetAngle, **2170**  
 ROTARY\_SetBitmap, **2171**  
 ROTARY\_SetDoRotate, **2172**  
 ROTARY\_SetMarker, **2173**  
 ROTARY\_SetOffset, **2174**  
 ROTARY\_SetPeriod, **2175**  
 ROTARY\_SetRadius, **2176**  
 ROTARY\_SetRange, **2177**  
 ROTARY\_SetSnap, **2178**  
 ROTARY\_SetTickSize, **2179**  
 ROTARY\_SetUserData, **2180**  
 ROTARY\_SetValue, **2181**  
 ROTARY\_SetValueRange, **2182**  
 SCROLLBAR\_AddValue, **2187**  
 SCROLLBAR\_Create, **2188**  
 SCROLLBAR\_CreateAttached, **2189**, 2189  
 SCROLLBAR\_CreateEx, **2190**  
 SCROLLBAR\_CreateIndirect, **2191**  
 SCROLLBAR\_CreateUser, **2192**  
 SCROLLBAR\_Dec, **2193**  
 SCROLLBAR\_GetColor, **2194**  
 SCROLLBAR\_GetDefaultWidth, **2195**  
 SCROLLBAR\_GetNumItems, **2196**  
 SCROLLBAR\_GetPageSize, **2197**  
 SCROLLBAR\_GetThumbSizeMin, **2198**  
 SCROLLBAR\_GetUserData, **2199**  
 SCROLLBAR\_GetValue, **2200**  
 SCROLLBAR\_Inc, **2201**  
 SCROLLBAR\_SetColor, **2202**  
 SCROLLBAR\_SetDefaultColor, **2203**  
 SCROLLBAR\_SetDefaultWidth, **2204**  
 SCROLLBAR\_SetNumItems, **2205**  
 SCROLLBAR\_SetPageSize, **2206**  
 SCROLLBAR\_SetSkinFlexProps, **2865**  
 SCROLLBAR\_SetState, **2207**  
 SCROLLBAR\_SetThumbSizeMin, **2208**  
 SCROLLBAR\_SetUserData, **2209**  
 SCROLLBAR\_SetValue, **2210**  
 SCROLLBAR\_SetWidth, **2211**  
 SCROLLER\_AttachToWindow, **2227**  
 SCROLLER\_CreateAttached, 2219, 2223, **2228**  
 SCROLLER\_CreateIndirect, **2229**  
 SCROLLER\_CreateUser, **2230**  
 SCROLLER\_EnableAutoResize, **2231**  
 SCROLLER\_EnableFade, **2232**  
 SCROLLER\_EnableTouch, **2233**  
 SCROLLER\_GetAlign, **2234**  
 SCROLLER\_GetAlignOffset, **2235**  
 SCROLLER\_GetAnimEase, **2236**  
 SCROLLER\_GetBkColor, **2237**  
 SCROLLER\_GetColor, **2238**  
 SCROLLER\_GetDefaultAlign, **2239**  
 SCROLLER\_GetDefaultAlignOffset, **2240**  
 SCROLLER\_GetDefaultAnimEase, **2241**  
 SCROLLER\_GetDefaultBkColor, **2242**  
 SCROLLER\_GetDefaultColor, **2243**  
 SCROLLER\_GetDefaultPeriod, **2244**  
 SCROLLER\_GetDefaultRadius, **2245**  
 SCROLLER\_GetDefaultSize, **2247**

SCROLLER\_GetDefaultSpacing, **2248**  
 SCROLLER\_GetDefaultThumbSizeMin, **2246**  
 SCROLLER\_GetPeriod, **2249**  
 SCROLLER\_GetRadius, **2250**  
 SCROLLER\_GetSize, **2252**  
 SCROLLER\_GetSpacing, **2253**  
 SCROLLER\_GetThumbRect, **2254**  
 SCROLLER\_GetThumbSizeMin, **2255**  
 SCROLLER\_GetUserData, **2256**  
 SCROLLER\_OwnerDraw, **2257**  
 SCROLLER\_ParentMsgHandler, 2222, **2259**  
 SCROLLER\_PreventIntersect, **2260**  
 SCROLLER\_SetAlign, **2261**  
 SCROLLER\_SetAlignOffset, **2262**  
 SCROLLER\_SetAnimEase, **2263**  
 SCROLLER\_SetBkColor, **2264**  
 SCROLLER\_SetColor, **2265**  
 SCROLLER\_SetContentRect, **2266**  
 SCROLLER\_SetDefaultAlign, **2267**  
 SCROLLER\_SetDefaultAlignOffset, **2268**  
 SCROLLER\_SetDefaultAnimEase, **2269**  
 SCROLLER\_SetDefaultBkColor, **2270**  
 SCROLLER\_SetDefaultColor, **2271**  
 SCROLLER\_SetDefaultPeriod, **2272**  
 SCROLLER\_SetDefaultRadius, **2273**  
 SCROLLER\_SetDefaultSize, **2275**  
 SCROLLER\_SetDefaultSpacing, **2276**  
 SCROLLER\_SetDefaultThumbSizeMin, **2274**  
 SCROLLER\_SetInterfaceAPI, 2223, **2277**  
 SCROLLER\_SetOwnerDraw, **2278**  
 SCROLLER\_SetPeriod, **2279**  
 SCROLLER\_SetRadius, **2280**  
 SCROLLER\_SetSize, **2282**  
 SCROLLER\_SetSpacing, **2283**  
 SCROLLER\_SetState, **2284**  
 SCROLLER\_SetThumbSizeMin, **2285**  
 SCROLLER\_SetUserData, **2286**  
 SIM\_GUI\_CreateLCDInfoWindow, **237**, 237  
 SIM\_GUI\_CreateLCDWindow, 234, 235, **238**  
 SIM\_GUI\_Delay, **203**  
 SIM\_GUI\_Enable, 233, 235, **239**  
 SIM\_GUI\_EnableModifierKey, **204**  
 SIM\_GUI\_ExecIdle, **205**  
 SIM\_GUI\_Exit, 234, **240**  
 SIM\_GUI\_GetCompositeTouch, **206**  
 SIM\_GUI\_GetTime, **207**  
 SIM\_GUI\_HandleKeyEvents, 233  
 SIM\_GUI\_Init, 234, 235, **241**  
 SIM\_GUI\_IsModifierKeyEnabled, **208**  
 SIM\_GUI\_SaveBMP, **209**  
 SIM\_GUI\_SaveBMPEx, **210**  
 SIM\_GUI\_SaveCompositeBMP, **211**  
 SIM\_GUI\_SetCallback, **212**  
 SIM\_GUI\_SetCompositeColor, **213**  
 SIM\_GUI\_SetCompositeSize, **214**, 3235  
 SIM\_GUI\_SetCompositeTouch, **215**  
 SIM\_GUI\_SetLCDColorBlack, **216**, 216, 216  
 SIM\_GUI\_SetLCDColorWhite, **216**, 216, 216  
 SIM\_GUI\_SetLCDPos, 201, 216, 216, **218**  
 SIM\_GUI\_SetLCDWindowHook, **242**  
 SIM\_GUI\_SetMag, **219**  
 SIM\_GUI\_SetTransColor, **220**  
 SIM\_GUI\_SetTransMode, **221**, 3235, 3235, 3235  
 SIM\_GUI\_ShowDevice, **222**  
 SIM\_GUI\_UseCustomBitmaps, **223**  
 SIM\_HARDKEY\_GetNum, **227**  
 SIM\_HARDKEY\_GetState, **228**  
 SIM\_HARDKEY\_SetCallback, **229**  
 SIM\_HARDKEY\_SetMode, **230**  
 SIM\_HARDKEY\_SetState, **231**  
 SLIDER\_Create, **2296**  
 SLIDER\_CreateEx, **2297**  
 SLIDER\_CreateIndirect, **2298**, 2743, 2743  
 SLIDER\_CreateUser, **2299**  
 SLIDER\_Dec, **2300**  
 SLIDER\_EnableFocusRect, **2301**

SLIDER\_GetBkColor, **2302**  
 SLIDER\_GetFocusColor, **2303**  
 SLIDER\_GetRange, **2304**  
 SLIDER\_GetUserData, **2305**  
 SLIDER\_GetValue, **2306**  
 SLIDER\_Inc, **2307**  
 SLIDER\_SetBkColor, **2308**  
 SLIDER\_SetDefaultFocusColor, **2309**  
 SLIDER\_SetFocusColor, **2310**  
 SLIDER\_SetInvertDir, **2311**  
 SLIDER\_SetNumTicks, **2312**, 2313  
 SLIDER\_SetRange, **2313**, 2313, 2313, 2313  
 SLIDER\_SetSkinFlexProps, **2871**  
 SLIDER\_SetUserData, **2314**  
 SLIDER\_SetValue, **2315**, 2744, 2745  
 SLIDER\_SetWidth, **2316**, 2744, 2745  
 SPINBOX\_CreateEx, **2323**  
 SPINBOX\_CreateIndirect, **2324**  
 SPINBOX\_CreateUser, **2325**  
 SPINBOX\_EnableBlink, **2326**  
 SPINBOX\_GetBkColor, **2327**  
 SPINBOX\_GetButtonBkColor, **2328**  
 SPINBOX\_GetDefaultButtonSize, **2329**  
 SPINBOX\_GetEditHandle, **2330**  
 SPINBOX\_GetFont, **2331**  
 SPINBOX\_GetRange, **2332**  
 SPINBOX\_GetTextColor, **2333**  
 SPINBOX\_GetUserData, **2334**  
 SPINBOX\_GetValue, **2335**  
 SPINBOX\_SetBkColor, **2336**  
 SPINBOX\_SetButtonBkColor, **2337**  
 SPINBOX\_SetButtonSize, **2338**  
 SPINBOX\_SetDefaultButtonSize, **2339**  
 SPINBOX\_SetEdge, **2340**  
 SPINBOX\_SetEditMode, **2341**  
 SPINBOX\_SetFont, **2342**  
 SPINBOX\_SetRange, **2343**  
 SPINBOX\_SetSkinFlexProps, **2876**  
 SPINBOX\_SetStep, **2344**  
 SPINBOX\_SetTextColor, **2345**  
 SPINBOX\_SetTimerPeriod, **2346**  
 SPINBOX\_SetUserData, **2347**  
 SPINBOX\_SetValue, **2348**  
 SWIPELIST\_AddItem, **2361**  
 SWIPELIST\_AddItemText, **2362**  
 SWIPELIST\_AddSepItem, **2363**  
 SWIPELIST\_CreateEx, **2364**  
 SWIPELIST\_CreateIndirect, **2365**  
 SWIPELIST\_CreateUser, **2366**  
 SWIPELIST\_DeleteItem, **2367**  
 SWIPELIST\_GetBitmap, **2368**  
 SWIPELIST\_GetBitmapSpace, **2369**  
 SWIPELIST\_GetBkColor, **2370**  
 SWIPELIST\_GetBorderSize, **2371**  
 SWIPELIST\_GetDefaultBitmapSpace, **2372**  
 SWIPELIST\_GetDefaultBkColor, **2373**  
 SWIPELIST\_GetDefaultBorderSize, **2374**  
 SWIPELIST\_GetDefaultFont, **2375**  
 SWIPELIST\_GetDefaultOverlap, **2376**  
 SWIPELIST\_GetDefaultSepColor, **2377**  
 SWIPELIST\_GetDefaultSepSize, **2378**  
 SWIPELIST\_GetDefaultTextAlign, **2380**  
 SWIPELIST\_GetDefaultTextColor, **2379**  
 SWIPELIST\_GetDefaultThreshold, **2381**  
 SWIPELIST\_GetFont, **2382**  
 SWIPELIST\_GetItemSize, **2383**  
 SWIPELIST\_GetItemUserData, **2384**  
 SWIPELIST\_GetNumItems, **2385**  
 SWIPELIST\_GetNumText, **2386**  
 SWIPELIST\_GetOverlap, **2387**  
 SWIPELIST\_GetReleasedItem, **2388**  
 SWIPELIST\_GetScrollPos, **2389**  
 SWIPELIST\_GetSelItem, **2390**  
 SWIPELIST\_GetSepColor, **2391**  
 SWIPELIST\_GetSepSize, **2392**  
 SWIPELIST\_GetText, **2393**

SWIPELIST\_GetTextAlign, **2394**  
SWIPELIST\_GetTextColor, **2395**  
SWIPELIST\_GetThreshold, **2396**  
SWIPELIST\_GetUserData, **2397**  
SWIPELIST\_IsSepItem, **2398**  
SWIPELIST\_ItemAttachWindow, **2399**  
SWIPELIST\_ItemDetachWindow, **2400**  
SWIPELIST\_OwnerDraw, **2401**  
SWIPELIST\_SetAttachedWindowPos, **2402**  
SWIPELIST\_SetBitmap, **2403**  
SWIPELIST\_SetBitmapSpace, **2404**  
SWIPELIST\_SetBkColor, **2405**  
SWIPELIST\_SetBorderSize, **2406**  
SWIPELIST\_SetDefaultBitmapSpace, **2407**  
SWIPELIST\_SetDefaultBkColor, **2408**  
SWIPELIST\_SetDefaultBorderSize, **2409**  
SWIPELIST\_SetDefaultFont, **2410**  
SWIPELIST\_SetDefaultOverlap, **2411**  
SWIPELIST\_SetDefaultSepColor, **2412**  
SWIPELIST\_SetDefaultSepSize, **2413**  
SWIPELIST\_SetDefaultTextAlign, **2415**  
SWIPELIST\_SetDefaultTextColor, **2414**  
SWIPELIST\_SetDefaultThreshold, **2416**  
SWIPELIST\_SetFont, **2417**  
SWIPELIST\_SetItemSize, **2418**  
SWIPELIST\_SetItemUserData, **2419**  
SWIPELIST\_SetOverlap, **2420**  
SWIPELIST\_SetOwnerDraw, **2421**  
SWIPELIST\_SetScrollPos, **2422**  
SWIPELIST\_SetScrollPosItem, **2423**  
SWIPELIST\_SetSepColor, **2424**  
SWIPELIST\_SetSepSize, **2425**  
SWIPELIST\_SetText, **2426**  
SWIPELIST\_SetTextAlign, **2427**  
SWIPELIST\_SetTextColor, **2428**  
SWIPELIST\_SetThreshold, **2429**  
SWIPELIST\_SetUserData, **2430**  
SWITCH\_AnimState, **2440**  
SWITCH\_CreateIndirect, **2441**  
SWITCH\_CreateUser, **2442**  
SWITCH\_DisableAnimation, **2443**  
SWITCH\_GetDefaultFont, **2444**  
SWITCH\_GetDefaultPeriod, **2445**  
SWITCH\_GetDefaultTextColor, **2446**  
SWITCH\_GetState, **2447**  
SWITCH\_GetUserData, **2448**  
SWITCH\_SetBitmap, **2449**  
SWITCH\_SetDefaultFont, **2450**  
SWITCH\_SetDefaultPeriod, **2451**  
SWITCH\_SetDefaultTextColor, **2452**  
SWITCH\_SetFont, **2453**  
SWITCH\_SetMode, **2454**  
SWITCH\_SetPeriod, **2455**  
SWITCH\_SetState, **2456**  
SWITCH\_SetText, **2457**  
SWITCH\_SetTextColor, **2458**  
SWITCH\_SetThumbSize, **2459**  
SWITCH\_SetUserData, **2460**  
SWITCH\_Toggle, **2461**  
TEXT\_GetDefaultFont, **2476**  
TEXT\_GetDefaultFrameColor, **2477**  
TEXT\_GetDefaultRotation, **2478**  
TEXT\_GetDefaultTextColor, **2479**  
TEXT\_GetDefaultWrapMode, **2480**  
TEXT\_SetDefaultFont, **2493**  
TEXT\_SetDefaultFrameColor, **2494**  
TEXT\_SetDefaultRotation, **2495**  
TEXT\_SetDefaultTextColor, **2496**  
TEXT\_SetDefaultWrapMode, **2497**  
TICKER\_CreateIndirect, **2512**  
TICKER\_CreateUser, **2513**  
TICKER\_GetBkColor, **2514**  
TICKER\_GetClickedItemIndex, **2516**  
TICKER\_GetCurrentItemIndex, **2515**  
TICKER\_GetDefaultAnimDist, **2517**  
TICKER\_GetDefaultAnimPeriod, **2518**



TICKER\_GetDefaultBkColor, **2519**  
 TICKER\_GetDefaultDist, **2520**  
 TICKER\_GetDefaultFont, **2521**  
 TICKER\_GetDefaultFrameColor, **2522**  
 TICKER\_GetDefaultTextColor, **2523**  
 TICKER\_GetFont, **2524**  
 TICKER\_GetFrameColor, **2528**  
 TICKER\_GetItemText, **2525**  
 TICKER\_GetTextAlign, **2526**  
 TICKER\_GetTextColor, **2527**  
 TICKER\_GetUserData, **2529**  
 TICKER\_SetBkColor, **2530**  
 TICKER\_SetConsecutive, **2531**  
 TICKER\_SetContinuousMode, **2532**  
 TICKER\_SetCurrentItemIndex, **2533**  
 TICKER\_SetDefaultAnimDist, **2534**  
 TICKER\_SetDefaultAnimPeriod, **2535**  
 TICKER\_SetDefaultBkColor, **2536**  
 TICKER\_SetDefaultDist, **2537**  
 TICKER\_SetDefaultFont, **2538**  
 TICKER\_SetDefaultFrameColor, **2539**  
 TICKER\_SetDefaultTextColor, **2540**  
 TICKER\_SetFont, **2541**  
 TICKER\_SetFrameColor, **2542**  
 TICKER\_SetItemDist, **2543**  
 TICKER\_SetItems, **2544**  
 TICKER\_SetItemText, **2545**  
 TICKER\_SetMovement, **2546**  
 TICKER\_SetTextAlign, **2547**  
 TICKER\_SetTextColor, **2548**  
 TICKER\_SetUserData, **2552**  
 TICKER\_SetWrapMode, **2549**  
 TICKER\_Start, **2550**  
 TICKER\_Stop, **2551**  
 TREEVIEW\_AttachItem, **2560**  
 TREEVIEW\_CreateEx, **2561**  
 TREEVIEW\_CreateIndirect, **2562**  
 TREEVIEW\_CreateUser, **2563**  
 TREEVIEW\_DecSel, **2564**  
 TREEVIEW\_GetDefaultBkColor, **2565**  
 TREEVIEW\_GetDefaultFont, **2566**  
 TREEVIEW\_GetDefaultLineColor, **2567**  
 TREEVIEW\_GetDefaultTextColor, **2568**  
 TREEVIEW\_GetItem, **2569**  
 TREEVIEW\_GetSel, **2570**  
 TREEVIEW\_GetUserData, **2571**  
 TREEVIEW\_IncSel, **2572**  
 TREEVIEW\_InsertItem, **2573**  
 TREEVIEW\_ITEM\_Collapse, **2594**  
 TREEVIEW\_ITEM\_CollapseAll, **2595**  
 TREEVIEW\_ITEM\_Create, **2596**  
 TREEVIEW\_ITEM\_Delete, **2597**  
 TREEVIEW\_ITEM\_Detach, **2598**  
 TREEVIEW\_ITEM\_Expand, **2599**  
 TREEVIEW\_ITEM\_ExpandAll, **2600**  
 TREEVIEW\_ITEM\_GetInfo, **2601**  
 TREEVIEW\_ITEM\_GetText, **2602**  
 TREEVIEW\_ITEM\_GetUserData, **2603**  
 TREEVIEW\_ITEM\_SetImage, **2604**  
 TREEVIEW\_ITEM\_SetText, **2605**  
 TREEVIEW\_ITEM\_SetUserData, **2606**  
 TREEVIEW\_ScrollToSel, **2574**  
 TREEVIEW\_SetAutoScrollH, **2575**  
 TREEVIEW\_SetAutoScrollV, **2576**  
 TREEVIEW\_SetBitmapOffset, **2577**  
 TREEVIEW\_SetBkColor, **2578**  
 TREEVIEW\_SetDefaultBkColor, **2579**  
 TREEVIEW\_SetDefaultFont, **2580**  
 TREEVIEW\_SetDefaultLineColor, **2581**  
 TREEVIEW\_SetDefaultTextColor, **2582**  
 TREEVIEW\_SetFont, **2583**  
 TREEVIEW\_SetHasLines, **2584**  
 TREEVIEW\_SetImage, **2585**  
 TREEVIEW\_SetIndent, **2586**  
 TREEVIEW\_SetLineColor, **2587**  
 TREEVIEW\_SetOwnerDraw, **2588**

TREEVIEW\_SetSel, **2589**  
 TREEVIEW\_SetSelMode, **2590**  
 TREEVIEW\_SetTextColor, **2591**  
 TREEVIEW\_SetTextIndent, **2592**  
 TREEVIEW\_SetUserData, **2593**  
 WHEEL\_AddBitmaps, **2621**  
 WHEEL\_AddText, **2622**  
 WHEEL\_ClrCenterBitmaps, **2624**  
 WHEEL\_ClrCenterBox, **2623**  
 WHEEL\_ClrCenterText, **2625**  
 WHEEL\_CreateEx, **2626**  
 WHEEL\_CreateIndirect, **2627**  
 WHEEL\_CreateUser, **2628**  
 WHEEL\_DelItemText, **2631**  
 WHEEL\_GetDefaultPeriod, **2629**  
 WHEEL\_GetItemText, **2630, 2630**  
 WHEEL\_GetNumText, **2633**  
 WHEEL\_GetNumTextItems, **2634**  
 WHEEL\_GetReleasedItem, **2635**  
 WHEEL\_GetSel, **2636**  
 WHEEL\_GetUserData, **2637**  
 WHEEL\_InsertItemText, **2638**  
 WHEEL\_IsMoving, **2639**  
 WHEEL\_MoveToPos, **2640**  
 WHEEL\_MoveToPosEx, **2641**  
 WHEEL\_OwnerDrawMorph, **2642**  
 WHEEL\_OwnerDrawPlain, **2643**  
 WHEEL\_SetAlign, **2644**  
 WHEEL\_SetBkColor, **2645**  
 WHEEL\_SetBox, **2646**  
 WHEEL\_SetCellBitmapAttrMorph, **2651**  
 WHEEL\_SetCellColorPlain, **2652**  
 WHEEL\_SetCenterBitmapAttr, **2647**  
 WHEEL\_SetCenterBitmaps, **2648**  
 WHEEL\_SetCenterBox, **2649**  
 WHEEL\_SetCenterColorPlain, **2650**  
 WHEEL\_SetCenterTextAttrMorph, **2653**  
 WHEEL\_SetCenterTextAttrPlain, **2654**  
 WHEEL\_SetDefaultPeriod, **2655**  
 WHEEL\_SetHBorder, **2656**  
 WHEEL\_SetItemText, **2657**  
 WHEEL\_SetMode, **2658**  
 WHEEL\_SetOverlay, **2659**  
 WHEEL\_SetOverlayColor, **2660**  
 WHEEL\_SetOwnerDraw, **2661**  
 WHEEL\_SetPeriod, **2662**  
 WHEEL\_SetSel, **2663**  
 WHEEL\_SetSizesMorph, **2664**  
 WHEEL\_SetSizesPlain, **2665**  
 WHEEL\_SetUserData, **2666**  
 WIDGET\_GetDefaultEffect, **1168**  
 WIDGET\_GetMinTimePerFrame, **1163**  
 WIDGET\_GetType, **1164**  
 WIDGET\_SetDefaultEffect, **1169**  
 WIDGET\_SetEffect, **1170**  
 WIDGET\_SetFocusable, **1171**  
 WIDGET\_SetMinTimePerFrame, **1172**  
 WINDOW\_CreateEx, **2671**  
 WINDOW\_CreateIndirect, **2672**  
 WINDOW\_CreateUser, **2673**  
 WINDOW\_GetUserData, **2674**  
 WINDOW\_SetBkColor, **2675**  
 WINDOW\_SetDefaultBkColor, **2676**  
 WINDOW\_SetUserData, **2677**  
 WM\_Activate, **989**  
 WM\_AttachWindow, **990, 3228**  
 WM\_AttachWindowAt, **991**  
 WM\_BringToBottom, **992**  
 WM\_BringToTop, **993**  
 WM\_BroadcastMessage, **994**  
 WM\_ClrHasTrans, **995**  
 WM\_CreateTimer, **1109, 1109**  
 WM\_CreateWindow, **974, 996, 996, 996, 1007, 1066, 1109, 1149, 1150**  
 WM\_CreateWindowAsChild, **969, 974, 997, 1007, 1007, 3227, 3227, 3227, 3227, 3227, 3227**  
 WM\_Deactivate, **998**  
 WM\_DefaultProc, **964, 999, 999, 1007, 1066, 1109, 1149, 1149, 2222, 2743, 2744, 2746, 3192**



WM\_MOTION\_SetThreshold, **1099**  
WM\_MoveChildTo, **1048**  
WM\_MoveTo, **1049**  
WM\_MoveWindow, 1007, **1050**  
WM\_MULTIBUF\_Enable, **1106**  
WM\_NotifyParent, **1051**  
WM\_Paint, **1052**  
WM\_Rect2Client, **1054**  
WM\_Rect2Screen, **1055**  
WM\_ReleaseCapture, **1056**  
WM\_ResizeWindow, **1057**  
WM\_RestartTimer, 1109, **1112**  
WM\_Screen2hWin, **1058**  
WM\_Screen2hWinEx, **1059**  
WM\_SelectWindow, **1060**, 1060  
WM\_SendMessage, **1061**  
WM\_SendMessageNoPara, **1062**  
WM\_SendToParent, **1063**  
WM\_SetCallback, **1064**, 1150, 1150  
WM\_SetCapture, **1065**  
WM\_SetCaptureMove, **1066**, 1066  
WM\_SetCreateFlags, **1067**, 1067  
WM\_SetDesktopColor, 974, 1007, 1066, **1068**  
WM\_SetDesktopColorEx, **1069**  
WM\_SetEnableState, **1070**  
WM\_SetFocus, **1071**  
WM\_SetHasTrans, **1072**  
WM\_SetId, **1073**  
WM\_SetModalLayer, **1074**  
WM\_SetpfPollPID, **1075**, 1075  
WM\_SetScrollPosH, **1127**  
WM\_SetScrollPosV, **1128**  
WM\_SetScrollState, **1129**  
WM\_SetSize, **1076**  
WM\_SetStayOnTop, **1081**  
WM\_SetTransState, **1082**  
WM\_SetUntouchable, **1077**  
WM\_SetUserClipRect, **1083**, 1083, 1083  
WM\_SetUserData, 1007, 1007, 1008, **1084**  
WM\_SetWindowPos, **1078**  
WM\_SetXSize, **1079**  
WM\_SetYSize, **1080**  
WM\_ShowWindow, **1085**, 2221  
WM\_TOOLTIP\_AddTool, 974, **1100**  
WM\_TOOLTIP\_Create, 973, 974, **1101**  
WM\_TOOLTIP\_Delete, **1102**  
WM\_TOOLTIP\_SetDefaultColor, **1103**  
WM\_TOOLTIP\_SetDefaultFont, **1104**  
WM\_TOOLTIP\_SetDefaultPeriod, **1105**  
WM\_Update, **1086**  
WM\_ValidateRect, **1088**  
WM\_ValidateWindow, **1089**  
WM\_XY2Client, **1091**  
WM\_XY2Screen, **1090**

## 17.2 Type index

CALENDAR\_DATE, **2768**  
 CHOOSEFILE\_GET\_DATA\_FUNC, 2791, **2794**  
 CHOOSEFILE\_INFO, **2791**  
 GUI\_ALPHA\_STATE, 358, **433**  
 GUI\_ANIM\_INFO, 753, **780**  
 GUI\_BITMAP\_STREAM, 1215  
 GUI\_BITMAPSTREAM\_INFO, **434**  
 GUI\_BITMAPSTREAM\_PARAM, 378, **435**  
 GUI\_BMP\_GET\_DATA\_FUNC, **461**  
 GUI\_CALLBACK\_VOID\_U8\_P, 459, 460  
 GUI\_CURSOR\_ANIM, **3088**, 3127  
 GUI\_DEVICE, 3260, 3344, 3350, 3361, 3371, 3388, 3392, 3396  
 GUI\_DIRTYDEVICE\_INFO, **868**  
 GUI\_DTA\_GET\_DATA\_FUNC, **445**  
 GUI\_FONTINFO, 704, **722**  
 GUI\_GET\_DATA\_FUNC, **3222**  
 GUI\_GET\_DATA\_FUNC\_I, **3223**  
 GUI\_GET\_DATA\_FUNC\_II, **3224**  
 GUI\_GIF\_GET\_DATA\_FUNC, **495**  
 GUI\_GIF\_IMAGE\_INFO, **493**  
 GUI\_GIF\_INFO, **494**  
 GUI\_GRADIENT\_INFO, 340, **436**  
 GUI\_JPEG\_GET\_DATA\_FUNC, **473**  
 GUI\_JPEG\_INFO, **472**  
 GUI\_JPEG\_WRITECLIPPEDPIXELS\_FUNC, **474**  
 GUI\_KEY\_STATE, **897**  
 GUI\_LANG\_GET\_DATA\_FUNC, **935**  
 GUI\_MATRIX, 521, 529, **537**  
 GUI\_MBITMAP\_CONFIG, **3007**  
 GUI\_MBITMAP\_PARAM, 3004, **3006**, 3006  
 GUI\_MEASDEV\_Handle, 2980  
 GUI\_MEMDEV\_Handle, 2928, 2928, 2933, 2938, 2942, 2949, 2949, 2955, 2955, 2965  
 GUI\_MOVIE\_GET\_DATA\_FUNC, **814**  
 GUI\_MOVIE\_INFO, 788, **812**  
 GUI\_MTOUCH\_EVENT, 3020, **3031**  
 GUI\_MTOUCH\_INPUT, 3020, **3032**  
 GUI\_PID\_STATE, 817, **822**, 825, 832, 853, 980, 1066, 1066  
 GUI\_PNG\_GET\_DATA\_FUNC, **503**  
 GUI\_POINT, 391, 391, 393, 393, 395, 395, **437**, 437, 2895, 2914, 2914, 2914  
 GUI\_POINTF, **538**  
 GUI\_PORT\_API, 3260, 3344, 3350, 3350, 3361, 3371, 3388, 3392, 3396  
 GUI\_QR\_INFO, **438**  
 GUI\_RECT, **439**  
 GUI\_SIGNAL\_EVENT\_FUNC, 3203  
 GUI\_SOFTLAYER\_CONFIG, 3236, **3251**  
 GUI\_SVG\_BBOX, **580**  
 GUI\_SVG\_DRIVER, **603**  
 GUI\_SVG\_EGL\_API\_STRUCT, **584**  
 GUI\_SVG\_GET\_DATA\_FUNC, **595**  
 GUI\_SVG\_GL\_API\_STRUCT, **585**  
 GUI\_SVG\_Handle, 520, 521, 522  
 GUI\_SVG\_HOOKS, **581**, 581  
 GUI\_SVG\_INFO, **582**  
 GUI\_SVG\_LOAD\_API\_CALLBACK, **596**  
 GUI\_SVG\_NANOVG\_API\_STRUCT, 518, **586**  
 GUI\_SVG\_NEMAVG\_API\_STRUCT, 516, **588**  
 GUI\_SVG\_OPENVG\_API\_STRUCT, 513, **591**  
 GUI\_SVG\_VGLITE\_API\_STRUCT, 510, **593**  
 GUI\_SVG\_VIEWBOX, **583**  
 GUI\_TTF\_CS, **723**  
 GUI\_TTF\_DATA, 675, **724**  
 GUI\_WAIT\_EVENT\_FUNC, 3204  
 GUI\_WRAPMODE, 266, **290**  
 GUI\_XBF\_GET\_DATA\_FUNC, **728**  
 IP\_FS\_API, **3059**, 3059  
 KEYBOARD\_CODES, **1697**, 1697  
 KEYDEF\_AREA, **1698**  
 KEYDEF\_BUTTON, **1702**  
 KEYDEF\_KEY, 1667, **1699**, 1699  
 KEYDEF\_KEYBOARD, **1695**, 1696  
 KEYDEF\_LINE, 1697, **1703**, 1703  
 KEYDEF\_SHIFT, 1667, **1700**, 1700  
 KEYDEF\_SWITCH, 1667, **1701**, 1701  
 LCD\_API\_COLOR\_CONV, 628

LCD\_COLOR, 628, 628, 628, 629, 3134, 3135, 3229  
LISTBOX\_Handle, 2189  
MENU\_ITEM\_DATA, **1913**  
MENU\_MSG\_DATA, 1873, 1873, **1914**  
SCROLLER\_INTERFACE\_API, 2223, **2287**, 2287  
SIM\_GUI\_INFO, **224**  
TOOLTIP\_INFO, 973, **1130**  
TREEVIEW\_ITEM\_INFO, **2607**  
WM\_GESTURE\_INFO, **3033**  
WM\_KEY\_INFO, **1131**, 2745  
WM\_MESSAGE, 964, 974, 974, 980, 999, 1007, 1066, 1109, **1132**, 1132, 1149, 1149, 1873, 2222, 2743, 2744,  
2745, 3192  
WM\_MOTION\_INFO, 971, **1133**  
WM\_MOVE\_INFO, **1134**  
WM\_PID\_STATE\_CHANGED\_INFO, **1135**  
WM\_SCROLL\_STATE, **1136**, 2220, 2221, 2287  
WM\_ZOOM\_INFO, **3034**